

A P A

The Engineered Wood Association

GLOSSARY



**PANEL HANDBOOK &
GRADE GLOSSARY**

APA

The Engineered Wood Association

DO THE RIGHT THING RIGHT™

Wood is good. It is the earth’s natural, energy efficient and renewable building material.

Engineered wood is a better use of wood. It uses less wood to make more wood products.

That’s why using APA trademarked plywood, oriented strand board and APA EWS glued laminated timbers is the right thing to do.

A few facts about wood.

- **We’re not running out of trees.** One-third of the United States land base – 731 million acres – is covered by forests. About two-thirds of that 731 million acres is suitable for repeated planting and harvesting of timber. But only about half of the land suitable for growing timber is open to logging. Most of that harvestable acreage also is open to other uses, such as camping, hiking, hunting, etc.
- **We’re growing more wood every day.** American landowners plant more than two billion trees every year. In addition, millions of trees seed naturally. The forest products industry, which comprises about 15 percent of forestland ownership, is responsible for 41 percent of replanted forest acreage. That works out to more than one billion trees a year, or about three million trees planted every day. This high rate of replanting accounts for the fact that each year, 27 percent more timber is grown than is harvested.
- **Manufacturing wood products is energy efficient.** Wood products made up 47 percent of all industrial raw materials manufactured in the United States, yet consumed only 4 percent of the energy needed to manufacture all industrial raw materials, according to a 1987 study.
- **Good news for a healthy planet.** For every ton of wood grown, a young forest produces 1.07 tons of oxygen and absorbs 1.47 tons of carbon dioxide.

Material	Percent of Production	Percent of Energy Use
Wood	47	4
Steel	23	48
Aluminum	2	8

Wood. It’s the right product for the environment.

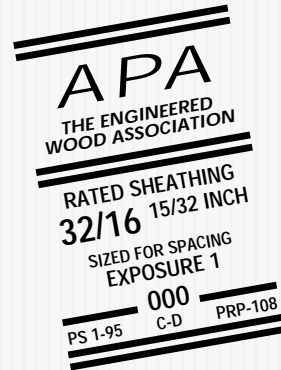

NOTICE:
The recommendations in this guide apply only to panels that bear the APA trademark. Only panels bearing the APA trademark are subject to the Association’s quality auditing program.

This glossary from APA – The Engineered Wood Association is designed as a handy reference guide to wood structural panel products and common construction terminology. It contains up-to-date information about APA Performance Rated Panels, plywood siding, sanded grades, panel construction systems, grading terminology, fasteners, finishing, and much more.

For more detailed information about APA panel products and construction systems, write for a free copy of the Publications Index, Form B300, P.O. Box 11700, Tacoma, Washington 98411-0700.

The Association maintains a comprehensive inventory of publications for architects, builders, dealers, do-it-yourselfers and others who use and specify wood structural panel products.

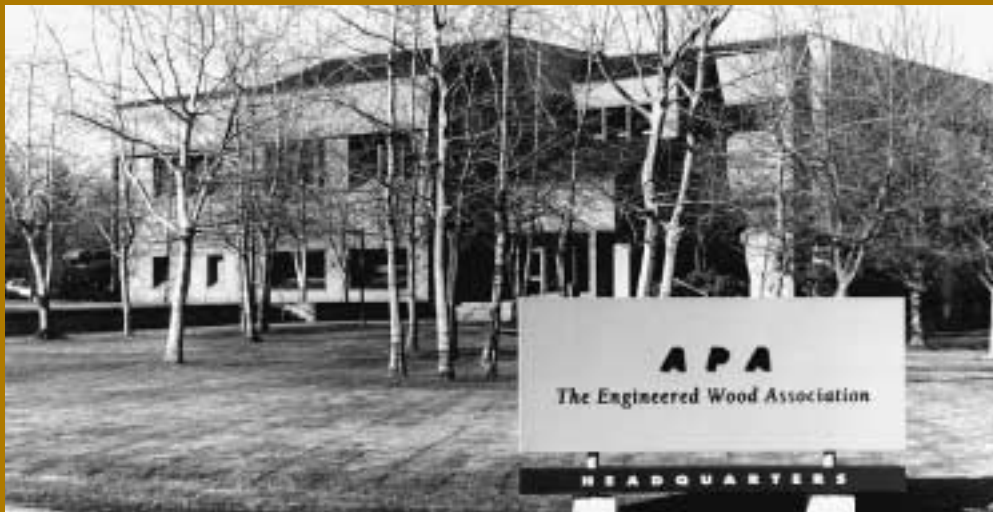

A

A-A

A sanded plywood panel with A-grade face and back plies and D-grade inner plies. Bonded with interior or exterior glue. Commonly used for cabinets, built-ins, furniture, partitions and other interior or protected applications where a smooth surface or appearance quality on both sides is important.

A-A • G-1 • EXPOSURE 1-APA • 000 • PS1-95

A-A Exterior

A sanded plywood panel with A-grade face and back plies and C-grade inner plies. Bonded with exterior glue. Commonly used for fences, built-ins, signs, boats, cabinets, commercial refrigerators, shipping containers, tanks, tote boxes, ducts and other exterior or high moisture applications where a smooth surface or appearance quality on both sides is important.

A-A • G-1 • EXT-APA • 000 • PS1-95

A-B

A sanded plywood panel with A-grade face, B-grade back and D-grade inner plies. Bonded with interior or exterior glue. Commonly used as a substitute for A-A where the appearance of one side is less important.

A-B • G-1 • EXPOSURE 1-APA • 000 • PS1-95

A-B Exterior

A sanded plywood panel with A-grade face, B-grade back and C-grade inner plies. Bonded with exterior glue. Commonly used as a substitute for A-A Exterior where the appearance of one side is less important.

A-B • G-1 • EXT-APA • 000 • PS1-95

A-C Exterior

A sanded plywood panel with A-grade face, C-grade back and C-grade inner plies. Bonded with exterior glue. Commonly used for soffits, fences, boxcar and truck linings, farm buildings, tanks, commercial refrigerators and other high-moisture applications where the appearance or smoothness of only one side is important.

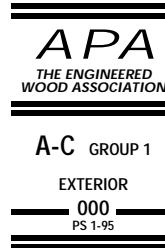

Acrylic Resin

An ingredient of water-base (latex) paints and stains. Synthetic resin with excellent weathering characteristics. Acrylics can be colorless and transparent, or pigmented.

Adhesive

See GLUE.

A-D

A sanded plywood panel with A-grade face, D-grade back and D-grade inner plies. Bonded with interior or exterior glue. Commonly used for paneling, built-ins, shelving, partitions and other interior or protected applications where the appearance or smoothness of only one side is important.

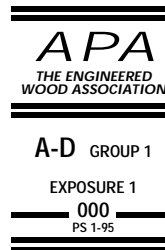

AFG-01

A performance specification developed by APA – *The Engineered Wood Association* for glues recommended for use in the APA Glued Floor System. AFG-01 requires that glues applied at the job site be sunlight resistant, strong under many moisture and temperature conditions, and able to fill gaps.

Aggregate-Coated Panel

A panel coated with stone chips imbedded in a resin coating.

Air-Dried

See SEASONING.

APA – *The Engineered Wood Association*

The trade organization representing most of the nation's wood structural panel manufacturers. The Association has three main functions: 1) research to improve plywood and other engineered wood products and systems, 2) quality inspection and testing to assure the manufacture of high quality panel products, and 3) promotion of panel products and building systems.

Anchor Bolt

Bolts that tie the sill plate and thus the frame of a structure to its foundation.

APA Glued Floor System

A floor system developed by APA in which a single layer of APA RATED STURD-I-FLOOR panels (or subflooring in the case of double-layer construction) is glue-nailed to wood joists. The bond is so strong that floor and joists behave like an integral unit, increasing floor stiffness and greatly reducing floor squeaks and nail popping. Only construction adhesives conforming to APA specification AFG-01 are recommended for use with the system. See T-BEAM.

APA Performance Rated Panels®

Panel products developed by APA – The Engineered Wood Association, such as APA RATED SHEATHING, APA RATED STURD-I-FLOOR and APA RATED SIDING, designed and manufactured to meet performance criteria for specific end-use applications. APA Performance Rated Panels can be manufactured as conventional veneered plywood, as composites (veneer faces bonded to reconstituted wood cores), or as mat-formed panels (including waferboard and oriented strand board.) The trademarks on APA Performance Rated Panels include a Span Rating denoting the maximum recommended spacing of supports over which the panel should be placed for the designated end use, and the exposure durability classification of the panel.

APA Rated® Sheathing

An APA Performance Rated Panel designed and manufactured specifically for residential and other light frame wall sheathing, roof sheathing and subflooring applications. APA RATED SHEATHING can be manufactured with Span Ratings of 12/0, 16/0, 20/0, 24/0, 24/16, 32/16, 40/20 and 48/24, in thicknesses ranging from 5/16 to 3/4 inches, and in three exposure durability classifications – Exterior, Exposure 1 and Exposure 2.



APA Rated® Siding

A grade designation covering APA proprietary siding products. Commonly used, in addition to siding, for fencing, soffits, wind screens and other exterior applications. Can be used for interior paneling. Can be manufactured as conventional veneered plywood, as a composite or as oriented strand board siding. Both panel and lap siding are available. Special surface treatment such as V-groove, channel groove, deep groove (such as APA Texture 1-11), brushed, rough sawn and texture-embossed (MDO). Span Rating (stud spacing for siding qualified for APA Sturd-I-Wall applications) and face grade classification (for veneer-faced siding) indicated in trademark.

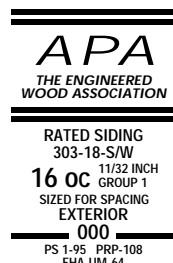

Brushed

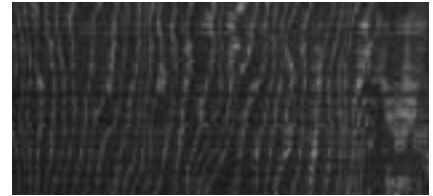

Rough sawn



APA Texture One-Eleven®



Kerfed



Reverse board & batten



Channel groove

APA Rated Sturd-I-Floor®

An APA Performance Rated Panel designed and manufactured specifically for residential and other light frame single-floor (combined subfloor-underlayment) applications for use under carpet. APA RATED STURD-I-FLOOR can be manufactured with Span Ratings of 16, 20, 24, 32 and 48 oc, in thicknesses ranging from 19/32 to 1-1/8 inch, and in three exposure durability classifications – Exterior, Exposure 1 and Exposure 2. Panels are available with either square edges or tongue-and-groove edges as specified. APA RATED STURD-I-FLOOR 48 oc plywood, commonly called 2-4-1, is also used in heavy timber roof construction.



APA Sturd-I-Wall®

A construction system in which APA Rated Siding panels or lap are attached directly to studs (single wall) or over nonstructural wall sheathing, such as fiberboard, gypsumboard or rigid foam insulation. APA Siding bearing a Span Rating of 24 oc in the trademark can be applied vertically direct to studs spaced 24 inches on center. Siding with a Span Rating of 16 oc can be used vertically direct to studs 16 inches on center. Panels with either Span Rating can be applied direct to studs 24 inches on center with face grain horizontal provided horizontal joints are blocked.

APA STURD-I-WALL®

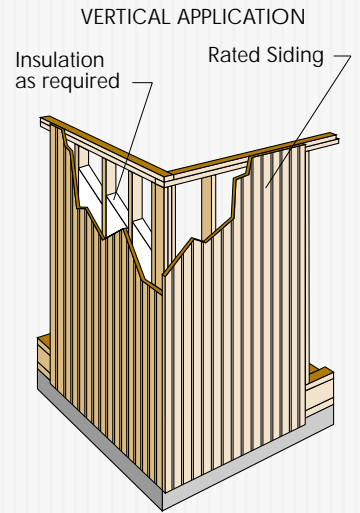

HORIZONTAL APPLICATION

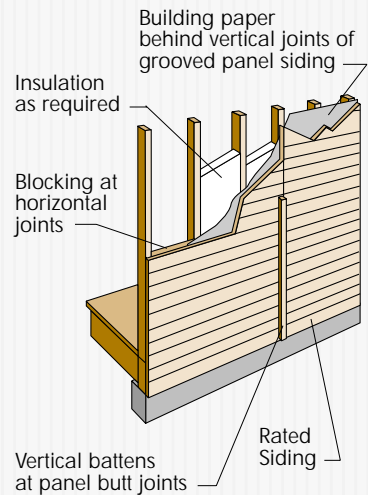

APA STURD-I-FLOOR®

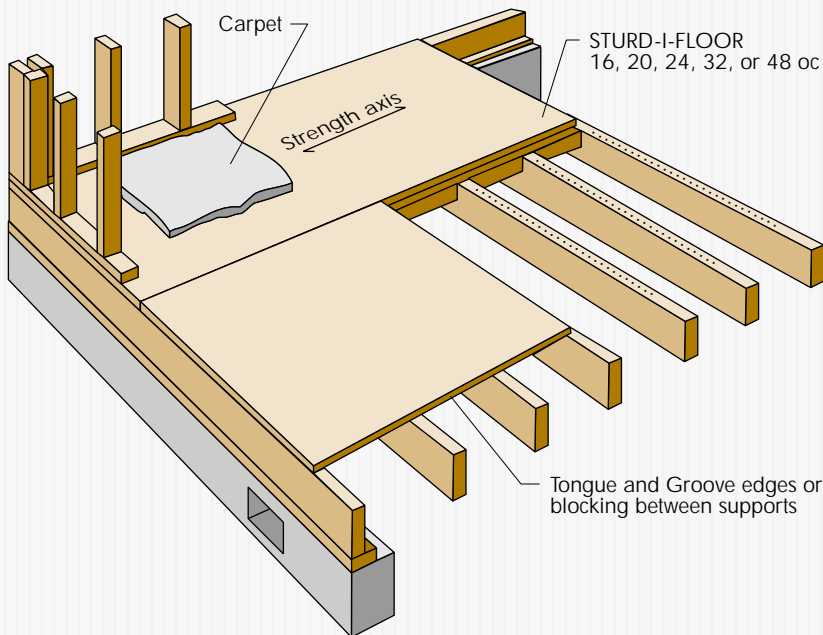

APA Trademark

APA – The Engineered Wood Association is an approved quality supervision and testing agency for softwood plywood and wood structural panels. Typical trademarks of APA member-manufactured products are shown throughout this brochure. See QUALITY INSPECTION AND TESTING.

Back-Out

See NAIL POPPING.

Back-Priming

Application of a coat of primer to the back of a panel. Cabinet doors should be back-primed to prevent warping.

Backstamp

The approved agency mark on the back of a panel. All unsanded and touch-sanded panels, and panels with A or B faces on one side only, carry the APA trademark on the panel back. See also APA TRADEMARK and EDGEMARK.

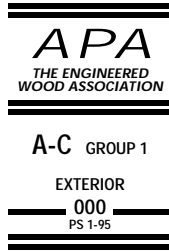

Batten

A thin, narrow strip of plywood or lumber used to conceal or protect a joint between adjoining pieces of lumber or plywood.

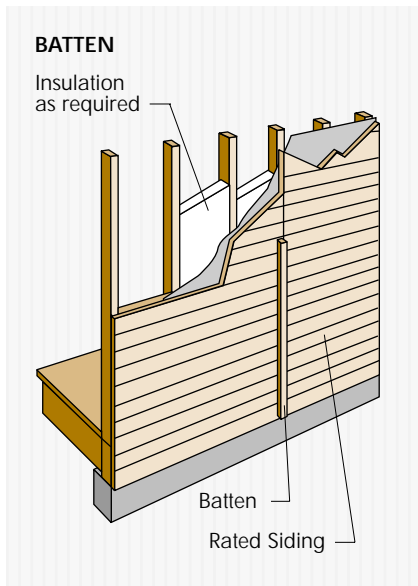

B-B

A sanded plywood panel with B-grade face and back and D-grade inner plies. Bonded with interior or exterior glue. Utility panel for interior or protected applications.



B-B Exterior

A sanded plywood panel with B-grade face and back and C-grade inner plies. Bonded with exterior glue. Utility panel with solid paintable surface both sides.



B-B Plyform®

Concrete form grades with high reuse factor. Sanded both sides and mill-oiled unless otherwise specified. Special restrictions on species. Also available in HDO for very smooth concrete finish, in STRUCTURAL I (all plies limited to Group I species), and with special overlays.

EXPOSURE DURABILITY CLASSIFICATION: Exterior.

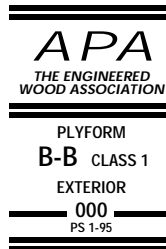

B-C Exterior

A plywood panel with sanded B-grade face, C-grade back and C-grade inner plies. Bonded with exterior glue. Utility panel for farm service and work buildings, boxcar and truck linings, containers, tanks, agricultural equipment, as a base for exterior coatings, etc.

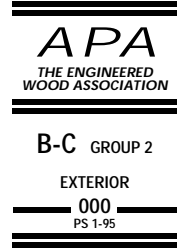

B-D

A plywood panel with sanded B-grade face, D-grade back and D-grade inner plies. Bonded with interior or exterior glue. Utility panel for backing, sides of built-ins, industry shelving, slip sheets, separator boards, bins, etc.

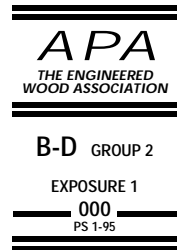

Bevel

To cut panel edges or ends at an angle to make smooth mating joints between panels.

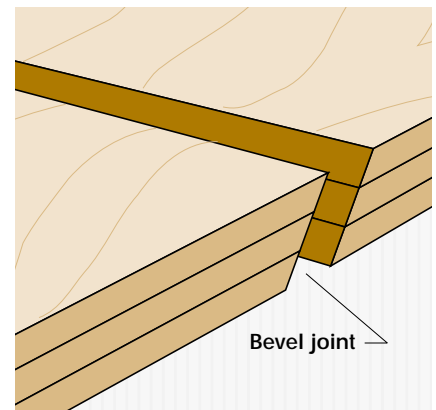

Blocking

Light lumber strips nailed between major framing members to support edges of structural panels where they meet.

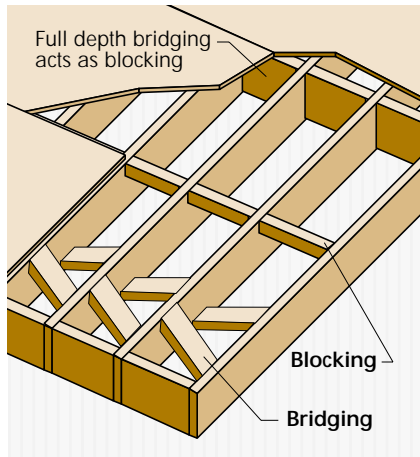

Blow

A localized delamination caused by steam pressure buildup during the hot pressing operation. The steam may result from high moisture content of the veneer, excessive glue spread, or high press temperatures.

Boat Patch

See REPAIRS.

Bond

To glue together, as veneers are “bonded” to form a sheet of plywood. Pressure is applied to keep mating parts in proper alignment. Most glues used in panel manufacture require both heat and pressure to cure properly.

Bow

Distortion of a wood structural panel so that it is not flat lengthwise. See also CUP.

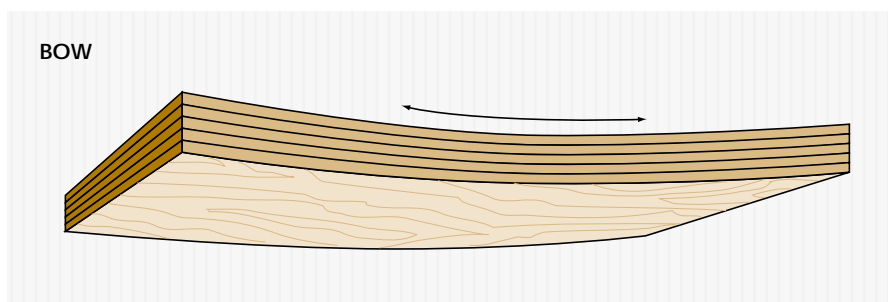

Box Beam

A beam built of lumber and wood structural panels in the form of a long hollow box which will support more load across an opening than will its individual members alone. Lumber members form the top and bottom (flanges) of the beam, while the sides (webs) are panels.

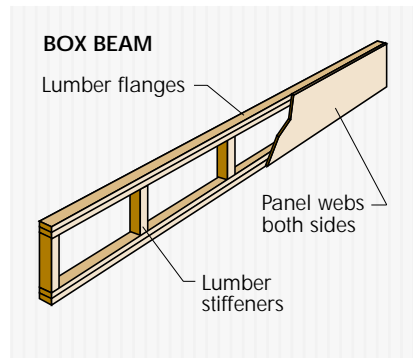

Bridging

Short wood or metal braces or struts placed crosswise between joists to help keep them in alignment. Bridging may be solid or crossed struts. Most building codes no longer require bridging of floor joists. See illustration under BLOCKING.

Brushed

An APA 303 Siding surface treatment. Brushed or relief-grain surfaces accent the natural grain pattern to create striking textures. Difficult to paint or stain. See APA RATED SIDING.

Bundle

A unit or stack of wood panels held together for shipment with bands. Stack size varies throughout the industry, with the average stack running about 30 to 33 inches high. A bundle 30 inches high, for example, contains 120 sheets of 1/4-inch panels, 80 sheets of 3/8-inch panels, or 60 sheets of 1/2-inch panels.

Butt Joint

The joint formed when two parts are fastened together without overlapping. For end-to-end joints, use a nailing strip. For corner joints, nail directly into panel if it is at least 3/4-inch thick. If panel is thinner than 3/4 inch, use a reinforcing block.

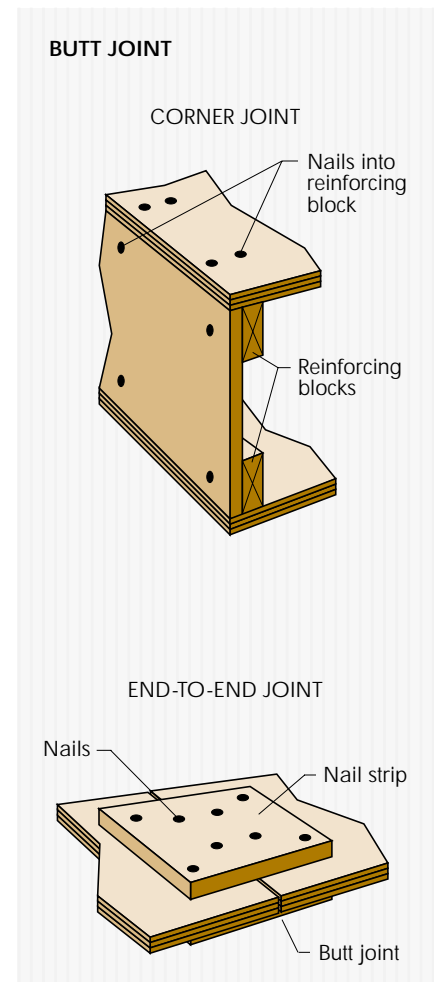

Caulk

Waterproof sealant used to fill joints or seams. Caulks are available as putties, ropes, or compounds extruded from cartridges.

C-C Plugged Exterior

A touch-sanded plywood panel with C-Plugged-grade face, C-grade back and inner plies. Bonded with exterior glue. Commonly used for severe moisture conditions, exterior balconies and decks, refrigerated or controlled atmosphere rooms, and boxcar and truck floors.

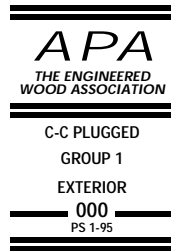

C-D Plugged

A touch-sanded plywood panel with C-Plugged-grade face, D-grade back and inner plies. Bonded with interior or exterior glue. Used for built-ins, cable reels and walkways.

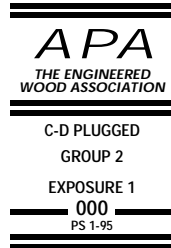

Center (Centers)

Inner ply or plies of a plywood panel whose grain runs parallel with that of the face and back plies.

Center Gap

See CORE GAP.

Center-To-Center

See ON-CENTER and CLEAR SPAN.

Chamfer

The flat surface created by slicing off the square edge or corner of a piece of wood or panel.

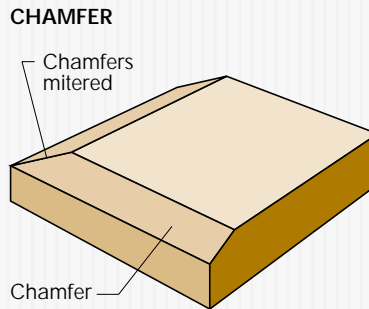

Channel Groove

An APA 303 Siding texture consisting of shallow grooves cut into panel faces during manufacture. See APA RATED SIDING.

Checking

Wood exposed to alternating moist and dry conditions eventually develops open cracks or "checks." Reduce checking by sealing panel edges before installation to minimize moisture absorption, and by using a priming coat or resin sealer on the surfaces.

Chord

Any of the outside members of a truss connected by web members. Also, may refer to perimeter members of a panel diaphragm. See illustration under TRUSS.

Circular Plug

See REPAIRS.

Class I

See B-B PLYFORM.

Clear Span

Distance between inside faces of supports.

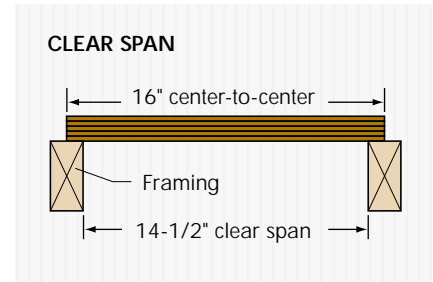

Code

See MODEL CODE.

COM-PLY®

APA – The Engineered Wood Association proprietary trade name for APA member-produced composite panels. See APA PERFORMANCE RATED PANELS and COMPOSITE PANEL.

Component

A glued and/or nailed structural assembly of wood structural panels and lumber, such as a stressed-skin panel. Also describes prefabricated building sections in panelized construction.

Composite Panel

A veneer-faced panel with a reconstituted wood core. See APA PERFORMANCE RATED PANELS and COM-PLY.

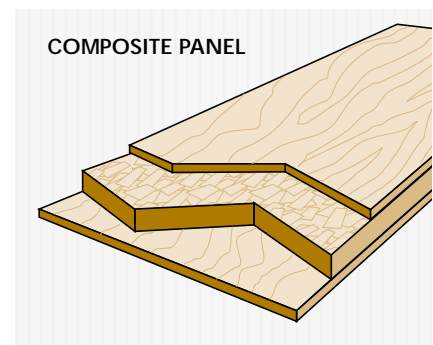

Concentrated Load

See LOADS.

Concrete Form

Mold into which fresh concrete is placed to set. Plywood provides tough, durable, easy-to-handle, split-resistant and lightweight concrete forms. It can be bent for curved forms and liners, and its natural insulating properties help moderate temperature variations for more consistent curing. Almost any APA trademarked plywood can be used in concrete formwork applications, but PLYFORM is specifically manufactured for that purpose. See also B-B PLYFORM.

Core (Cores)

In conventional plywood, inner plies whose grain runs perpendicular to that of the outer plies. In composite panels, a layer of reconstituted wood.

See also PLY.

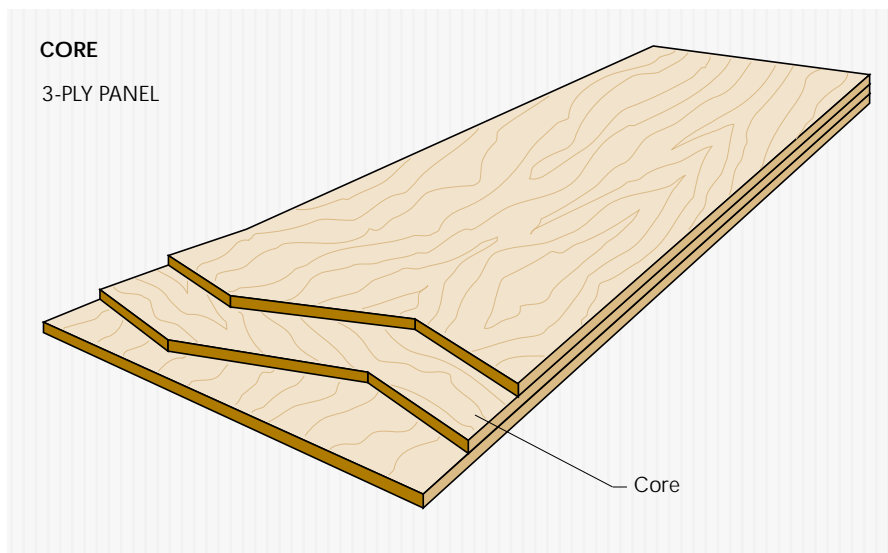

Core Gap (Center Gap)

An open veneer joint extending through, or partially through, a plywood panel. Product Standard PS 1 specifies that the average of all gaps shall not exceed 1/2 inch, and that every effort be made to produce closely butted core joints.

Crawl Space

A space often about two feet high beneath a house floor allowing access to plumbing or wiring. See also PIRF.

Cripple

Any vertical framing member cut less than full length, as in cripple studs under a window opening.

Crossband (Cores)

In plywood, the veneer layers with grain direction perpendicular to that of the face plies. See CORE.

Cross Cutting

Sawing wood across the grain. Because the wood in wood structural panels is either cross-laminated or randomly oriented, any cut made in a wood structural panel is a cross cut. Always use a cross-cut saw when hand- or power-sawing wood structural panels.

Cup

Crosswise distortion of a wood structural panel from its flat plane. See also BOW.

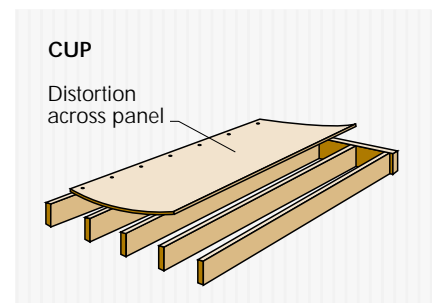

Curved Panel

Stressed-skin or sandwich panels curved to various degrees of arc. Used in roof construction.

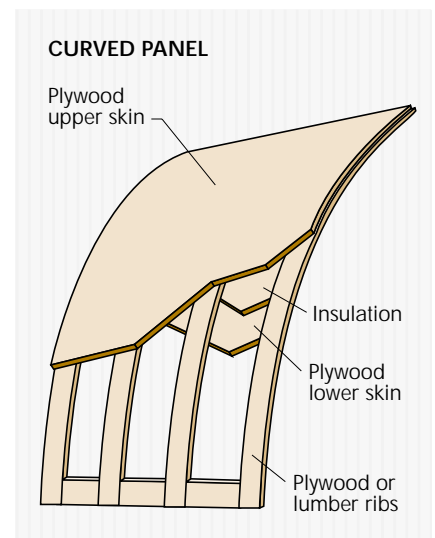

Dado Joint

Joint formed by intersection of two boards, one of which is notched with a rectangular groove.

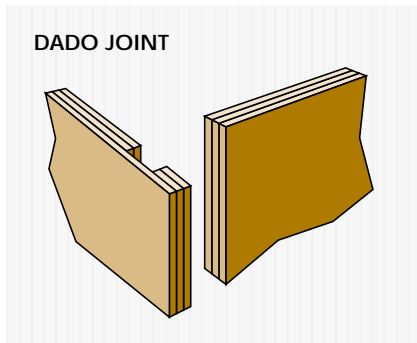

Dead Load (D.L.)

See LOADS.

Decorative Panel

A plywood panel grade with rough-sawn, brushed, grooved or striated faces. May be any exposure durability. Common uses include paneling, built-ins, accent walls, counter facings and displays. Exterior uses include siding, gable ends and fences. Check with manufacturer for specific Exterior application recommendations, which vary with particular products.



Deflection

Bending of a wood structural panel or framing member between supports under an applied load.

Delamination

Separation between plies or within reconstituted wood due to adhesive bond failure. Separation in area immediately over or around a permitted defect does not constitute delamination.

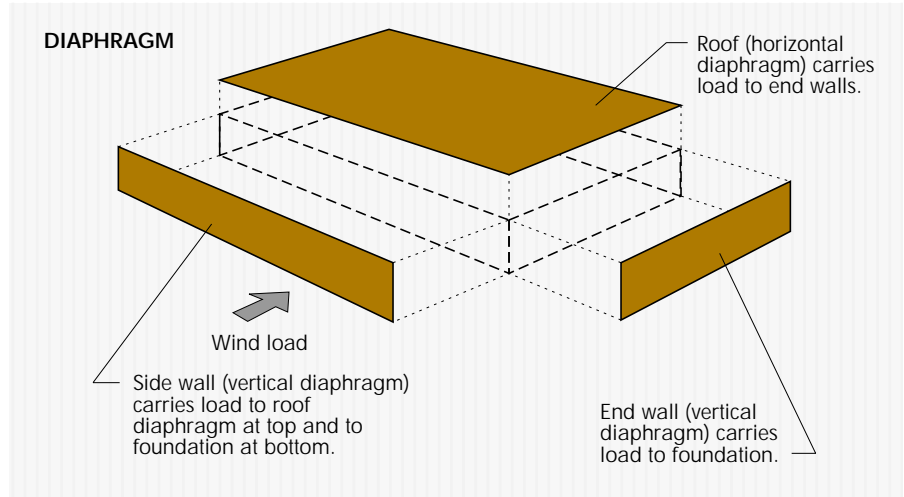

Diaphragm

Elements of a building that provide shear strength to withstand wind and earthquake loads.

Dogbone Plug

See REPAIRS.

Double Wall

A light frame wall construction system consisting of exterior finish siding, such as APA RATED SIDING, applied over structural wall sheathing – typically APA RATED SHEATHING. See APA STURD-I-WALL.

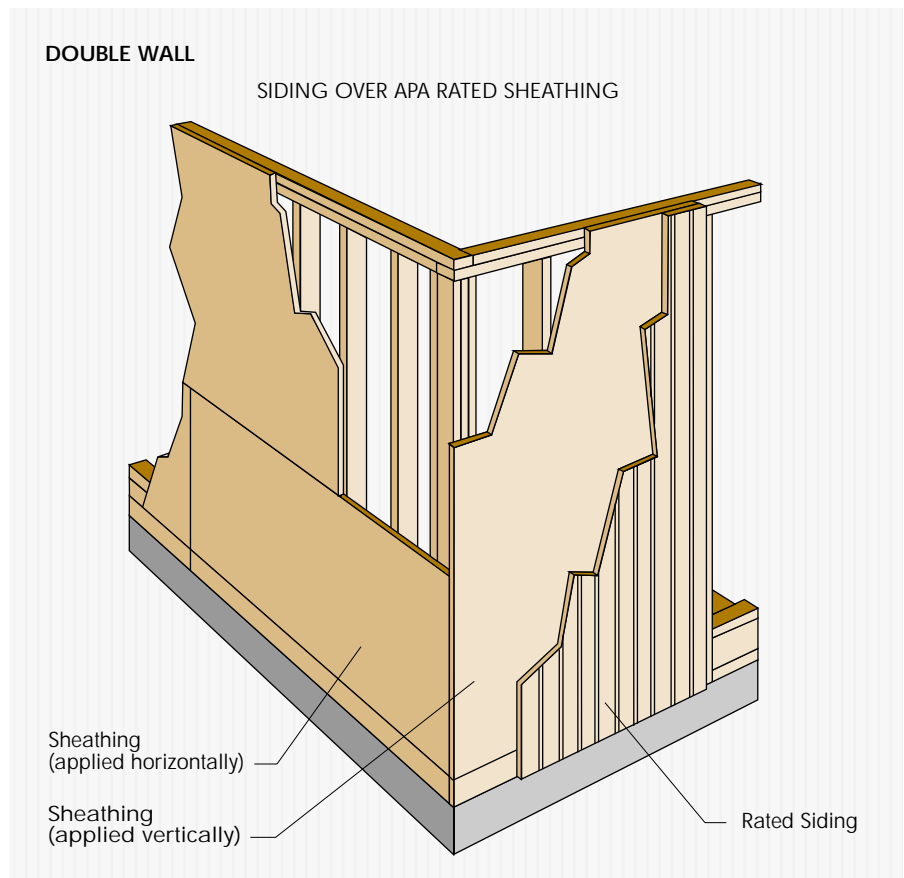

Eave

The edge of a roof that extends beyond or overhangs a wall. The underside of an eave may form an “open soffit.” Textured panels, applied face down to eave rafters as roof sheathing, give open soffits a decorative finished surface. See SOFFIT.

Edgemark

APA trademark stamped on the panel edge. Appears on sanded grades with B-grade or better veneer faces, PLYRON, MARINE, and panels with overlaid surfaces on both sides.

A-B • G-1 • EXT-APA • 000 • PS1-95

Edge Sealing

Application of a coating (e.g., sealant, paint) to the edges of a wood structural panel to reduce its water absorption. Edge seal before painting the panel surface if panel edges will be exposed to repeated wetting and drying.

Edge Spacing

See PANEL SPACING.

Edge Support

Support, such as panel clips or lumber blocking, installed between framing members at wood structural panel edges to transfer loads from one panel to the other across the joint. Panels with tongue-and-groove edges can be used in many applications without additional edge support.

Edge Treatment

Edge finishing method, such as banding with wood or plastic, or filling with putty or spackle.

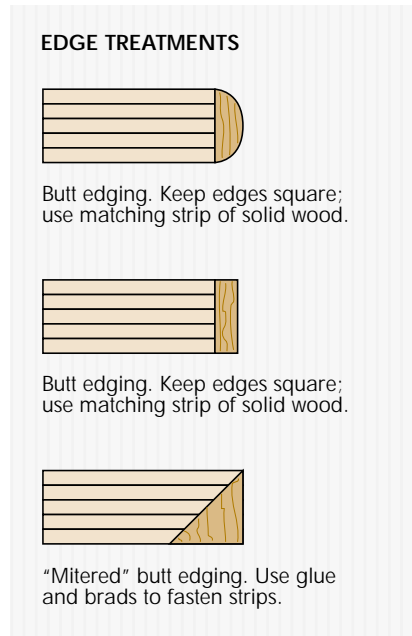

Edge Void

A panel defect in which the edge or end of an inner ply has split or broken away during manufacture, leaving a gap in the edge of the plywood panel.

Embossed

A panel surface treatment. Heat and pressure against a master pattern impress a variety of textured effects into panel surfaces, which remain smooth and paintable.

End Grain

The end of a piece of wood exposed when the wood fibers are cut across the grain. All wood structural panel edges are end grain, and should be finished accordingly.

End Spacing

See PANEL SPACING.

Engineered 24" Framing

A building system using wood structural panels over lumber framing spaced 24 inches on center in walls, floors and roof. The system’s series of in-line frames – trusses, studs and joists – provide cost-effective materials utilization and simpler, faster construction. It is recognized by major model codes and the FHA.

Expansion

Moisture absorption causes wood to expand. Spacing between panel edges and ends is recommended to allow for any possible panel swelling. See PANEL SPACING.

Exposure Durability Classification

Exposure ratings for APA wood structural panels designated in APA trademarks as Exterior, Exposure 1, Exposure 2, or Interior.

Exterior panels have a fully waterproof bond and are designed for applications subject to permanent exposure to the weather or to moisture.

Exposure 1 panels have a fully waterproof bond and are designed for applications where long construction delays may be expected prior to providing protection, or where high moisture conditions may be encountered in service. Exposure 1 panels are made with the same exterior adhesives used in Exterior panels. However, because other compositional factors may affect bond performance, only Exterior panels should be used for permanent exposure to the weather.

Exposure 2 panels (identified as Interior with intermediate glue under PS 1) are intended for protected construction applications where only moderate delays in providing protection from moisture may be expected.

Interior panels or panels which lack further glueline information in their trademarks are manufactured with interior glue and are intended for interior applications only.

Exposure 1

See EXPOSURE DURABILITY CLASSIFICATION.

Exposure 2

See EXPOSURE DURABILITY CLASSIFICATION.

Exterior

PS 1 exposure durability term for plywood manufactured for permanent outdoor or marine use and bonded with 100 percent waterproof adhesives. See INTERIOR and EXPOSURE DURABILITY CLASSIFICATION.

Exterior Glue

A 100 percent waterproof adhesive bonding all Exterior, Exposure 1 and most Interior panels. For applications subject to temporary exposure to moisture during construction, specify Exposure 1 or Exposure 2. For permanent exposure to weather or moisture, use only Exterior panels. See also INTERIOR GLUE, INTERMEDIATE GLUE and EXPOSURE DURABILITY CLASSIFICATION.

Face

The highest-grade side of any veneer-faced panel that has outer plies of different veneer grades. Also, either side of a panel where grading rules draw no distinction between faces. For example, the face of an A-C panel is the side with the A-grade outer ply. Both sides of an A-A or B-B panel are referred to as faces.

Face-Checking

Partial separation of wood fibers parallel to grain in the wood or veneer surfaces of panels caused chiefly by the strains of weathering and seasoning. See CHECKING.

Face Grain

Direction of the grain of the outer ply (face) of a veneer-faced panel in relation to its supports. A panel's greatest stiffness and strength is parallel to the face grain. Therefore, in construction, run the face grain or long dimension of the panel across supports for greatest stiffness and strength.

Fascia

Wood or plywood trim used along the eave or the gable end of a structure.

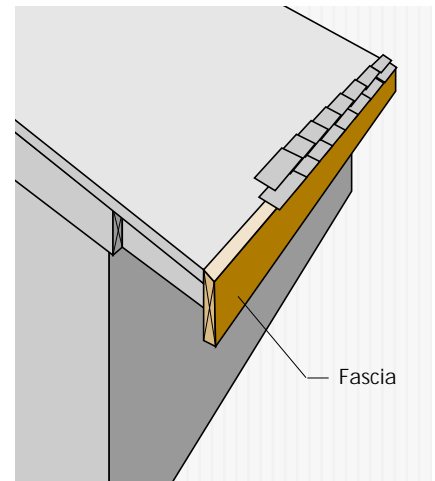

Fiberglass-Reinforced Plastic (FRP)

A tough, nonscuff plywood coating made of glass fibers combined with resins. These coated panels (composite) are used in truck and trailer bodies, containers and concrete forms. Seamless panels 40 feet long and longer can be produced as trailer sidewalls or roofs.

Filler

A material for filling nail holes, checks, cracks or other blemishes in surfaces of wood before application of paint, varnish or other finishes.

Finishes

Stains, paints or sealers which protect, color or enhance the natural beauty of wood structural panels.

Exterior finishes primarily protect siding and maintain its appearance. They minimize the weathering action which roughens and erodes the surface of unfinished wood. Different finishes give varying degrees of protection so the type, quality, quantity and application must be considered to achieve the desired performance. All exterior panel edges should be sealed if the panels will be painted or stained. Sealing while panels are stacked is easiest. Exterior finishes recommended for wood structural panels include semi-transparent stain, solid-color stain and acrylic latex paint.

Interior finishes: Preparation is minimal. Overlaid (MDO and HDO) plywood needs no preparation; sanded and textured grades require only touch-sanding. Recommended interior finishes include oil base paint, latex paint, stain and sealer.

Fire-Rated Systems

Wall, floor and roof construction of specific materials and designs that has been tested and rated according to fire safety criteria (e.g., flame spread rate and fire resistance). Testing and approval are performed by agencies such as Underwriters Laboratories, Inc. A

one-hour rating, for example, means that an assembly similar to that tested will neither collapse nor transmit flame or high temperature for at least one hour after a fire starts. Structural wood panels are an approved material in a number of fire-rated designs. See FLAME SPREAD.

Fire-Retardant-Treated (FRT)

Chemical treatment of wood and plywood to retard combustion. Plywood is pressure-impregnated with fire retardant chemicals mixed in water in accordance with American Wood Preservers Association Standard AWPA C27. NOTE: Span Ratings and load capacities are based on untreated panels, and may not apply following fire-retardant treatment. Obtain structural performance characteristics of FRT panels from the company providing the treatment and redrying service.

Flame Spread

The spread of fire along the surface of a material. Flame spread ratings are expressed in numbers or letters and are used in building code interior finish requirements.

Flange

Top and bottom longitudinal members of a beam. Box beams are fabricated with lumber flanges (top and bottom) and structural wood panel webs (sides). See BOX BEAM.

Flashing

See Z FLASHING.

Foam Core

Center of a structural wood panel-faced “sandwich” panel. Liquid plastic foamed into all spaces between the panels serves to both insulate and support the component skins. Or structural wood panel skins are pressure-glued to both sides of rigid plastic foam boards or billets. See SANDWICH PANEL.

Footing

The base for foundation walls, posts, chimneys, etc. The footing is wider than the member it supports, and distributes the weight of the structure to the ground over a larger area to prevent settling.

Frame Construction

Construction in which the structural parts are wood or dependent on a wood framework for support. Typically, lumber framing is sheathed with wood structural panels for roofs, walls and floor. The classification of frame construction remains the same in building codes even when masonry covering is applied on exterior walls.

FRP

See FIBERGLASS-REINFORCED PLASTIC.

FRT

See FIRE-RETARDANT-TREATED.

Furring

Process of leveling parts of a ceiling, wall or floor by means of wood strips, called furring strips, before adding panel cover.

FRAME CONSTRUCTION

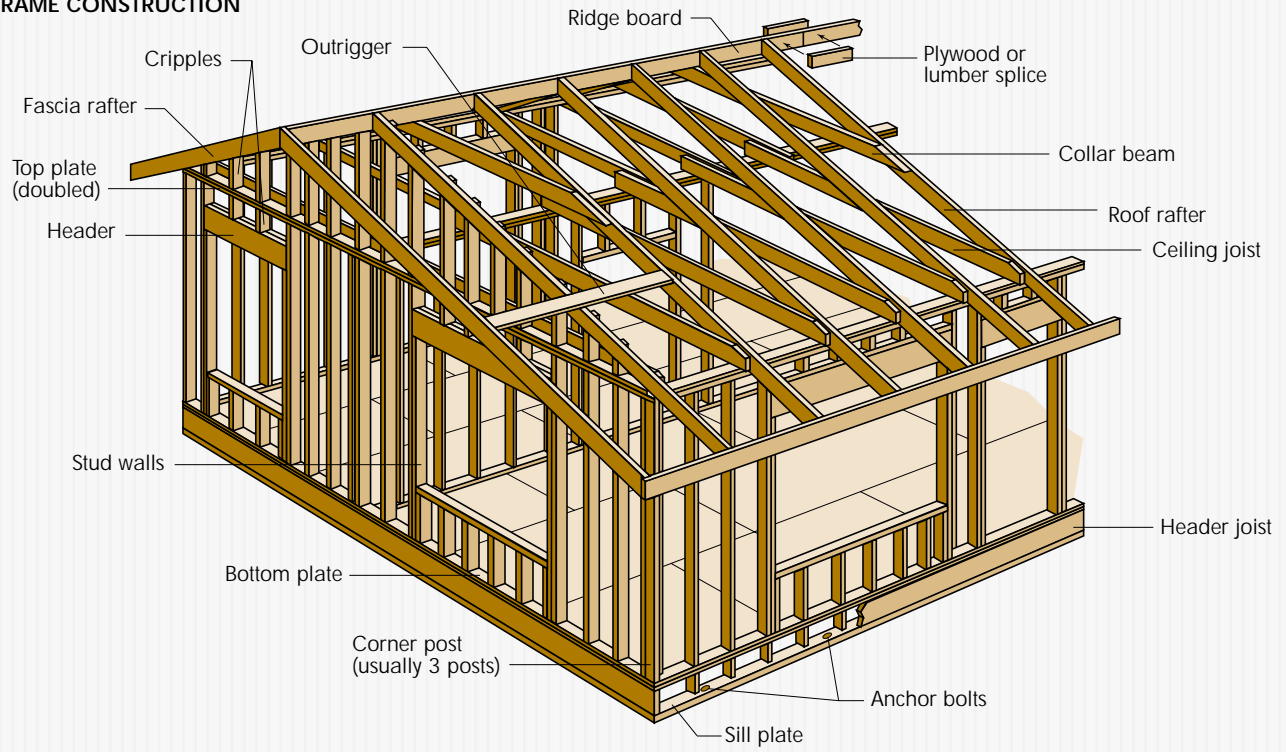

FRAME CONSTRUCTION

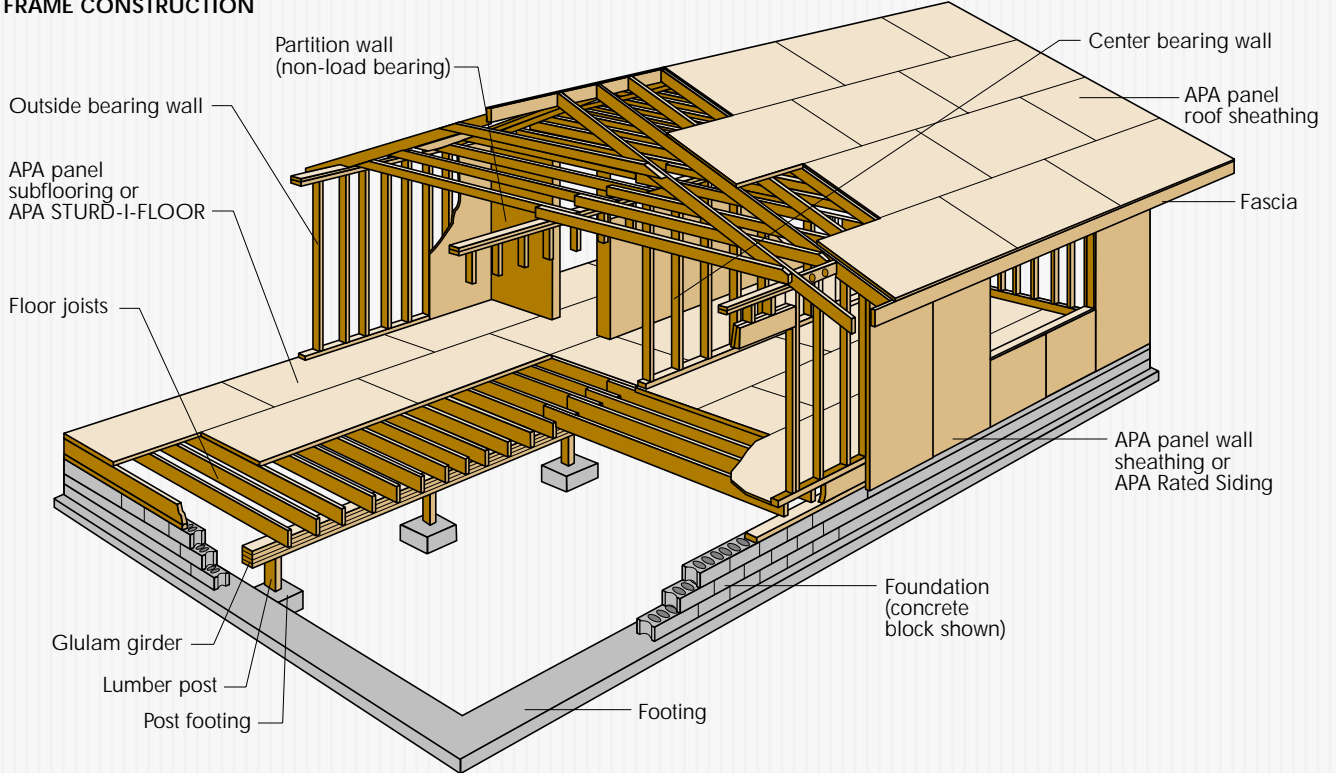

Girder

A large horizontal beam which supports interior walls or joists. Most wood frame houses have a lengthwise center girder that supports the joists and floor panels. See FRAME CONSTRUCTION.

Glue

Many adhesives, preferably in conjunction with nails or other fasteners, produce strong joints in structural wood panel construction. Type depends on purpose and exposure of finished product. The most common glues are listed in the chart below.

Other available glues include: **Hot melt glues** – for relatively small parts. Remember they cool and set quickly. **Epoxy glues** – limited use; most are not formulated for wood. Expensive. **Contact Cements** – useful for applying laminates and edge stripping to plywood. Not recommended for structural joints. **Wall panel adhesives** – handy for applying decorative paneling or facing. May require a few nails per panel to position panels while glue sets. **Casein glues** – slow setting, permitting easier construction of difficult assemblies.

Glue-Nailed (Nail-Glued)

Gluing wood structural panel joints and connections with pressure provided by nailing. For most effective fastening,

pieces should meet continuously along their joint. Apply glue to one or both surfaces according to manufacturer's directions, then press surfaces together and nail in place. For work such as cabinets or drawers, or whenever possible, joint should be clamped as well as nailed to maintain pressure until glue sets.

Glued Floor System

See APA GLUED FLOOR SYSTEM.

Glueline

The adhesive joint formed between veneers in a plywood panel or between face veneers and core in a composite panel (**primary glueline**), or between lumber and wood structural panel parts in an assembly such as a component (**secondary glueline**).

GLUES

Type of Glue	Description	Recommended Use	Precautions	How to Use
Urea Resin Glue	Comes as powder to be mixed with water and used within 4 hours. Light colored. Very strong if joint fits well.	Good for general wood gluing. For work that must stand some exposure to dampness, but is not completely waterproof.	Needs well-fitted joints, tight clamping, and room temperature 70° or warmer. Some require heat to cure.	Make sure joint fits tightly. Mix glue and apply thin coat. Allow 16 hours drying time.
Liquid Resin (White) Glue	Comes ready to use at any temperature. Clean-working, quick-setting. Strong enough for most work, though not quite as tough as urea resin glue.	Good for indoor furniture and cabinetwork. First choice for small jobs where tight clamping or good fit may be difficult.	Not sufficiently resistant to moisture for outdoor furniture or outdoor storage units.	Use at any temperature but preferably above 60°. Spread on both surfaces, clamp at once. Sets in 1-1/2 hours.
Resorcinol (Waterproof) Glue	Comes as powder plus liquid, must be mixed each time used. Dark colored, very strong, completely waterproof.	This is the glue to use with Exterior-type plywood for work to be exposed to extreme dampness. Good for farm buildings, boats.	Expense, mixing difficulty and dark color make it unsuited to jobs where waterproof glue is not required. Needs good fit, tight clamping.	Use within 8 hours after mixing. Work at temperature above 70°. Apply thin coat to both surfaces; allow 16 hours drying time.

Glulam

Short for glued-laminated structural timber – large beams fabricated by bonding layers of specially selected lumber with strong, durable adhesives. End and edge jointing permit production of longer and wider structural wood members than are normally available. Glulam timbers are used with wood structural panels for many types of residential and commercial construction.

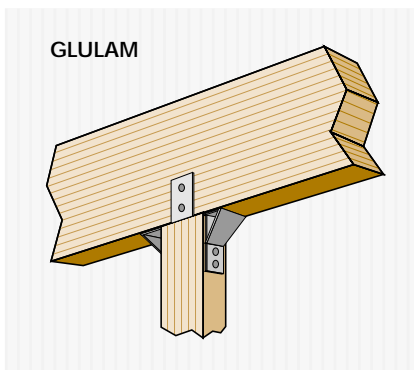

Grade

Refers to the letter-graded quality of veneers used in plywood manufacture (N, A, B, C-Plugged, C and D), or to particular panels, e.g., A-A, Underlayment, etc. See also VENEER GRADE.

Grain

The natural growth pattern in wood. The grain runs lengthwise in the tree and is strongest in that direction. Similarly, grain usually runs the long dimension in the face and back veneers of a plywood panel, making it stronger in that direction. Wood structural panels should therefore usually be applied with the long dimension perpendicular to or across supports.

Grain Raise

The condition on the surface of a plywood panel resulting from harder or denser wood fibers swelling and rising above softer surrounding wood.

Groove

One of the surface treatments frequently given to textured siding in which a series of narrow, parallel channels are cut into the surface of the panel.

Grooving is available in a variety of widths and spacings on several surface textures. See also APA RATED SIDING and TONGUE-AND-GROOVE JOINT.

Group Number

Plywood is manufactured from over 70 species of softwood. These species are classified according to strength and stiffness under manufacturing standard PS 1 into Groups 1 through 5. Group 1 woods are the strongest. The group number of a particular panel is determined by the weakest (highest numbered) species used in face and back (except for some thin panels where strength parallel to face grain is unimportant).

Growth Ring

A tree's annual cross-sectional growth layer, including springwood and summerwood.

Gusset Plate

A piece of plywood connecting lumber members of a truss or other frame structure. Gussets may be applied to one or both sides of the joint. Plywood is used because of its great strength and split-resistance.

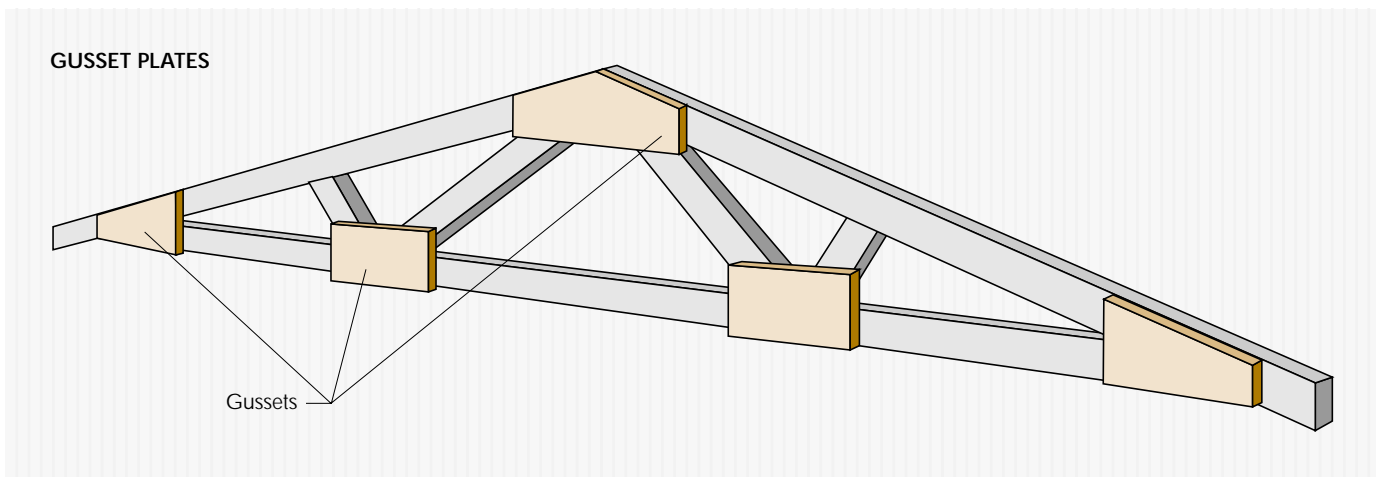

Hardwood

Wood of the deciduous or broadleaved trees – oak, maple, ash, walnut – as distinct from the softwood of the coniferous or needleleaved trees – pine, fir, spruce, hemlock. The term has only a general reference to actual wood hardness. Construction and industrial plywood may use either variety. See **SOFTWOOD**.

HDO

See **HIGH DENSITY OVERLAY**.

Header

A cross member placed between studs or joints to support loads over openings for stairways, chimneys, doors, etc. See also **FRAME CONSTRUCTION**.

Heartwood

The nonactive core of a tree distinguishable from the growing sapwood by its usually darker color and greater resistance to rot and decay.

Heavy Timber

A building code designation for a particular type of construction with good fire endurance. Heavy Timber is widely recognized as comparable to one-hour construction. A panel roof deck of 1-1/8-inch tongue-and-grooved plywood with exterior glue over 4-inch-wide supports meets the Heavy Timber requirements and provides the same fire performance as nominal 2-inch tongue-and-groove lumber decking.

High Density Overlay (HDO)

Plywood finished with a resin-impregnated fiber overlay to provide extremely smooth hard surfaces that need no additional finishing and have high resistance to chemicals and abrasion. The overlay material is bonded to both sides of the plywood as an integral part of the panel faces. Used for concrete forms, cabinets, highway signs, counter-tops and other punishing applications. See also **MEDIUM DENSITY OVERLAY (MDO)**.

I

I-Beam

See **I-Joist**.

Identification Index

Former term for **Span Rating**. See **SPAN RATING**.

IIC

See **IMPACT INSULATION CLASS**.

I-Joist

Joist whose cross section resembles the letter "I". The flanges of an I-joist are composed of lumber or laminated veneer lumber (LVL), and the web is composed of plywood or oriented strand board.

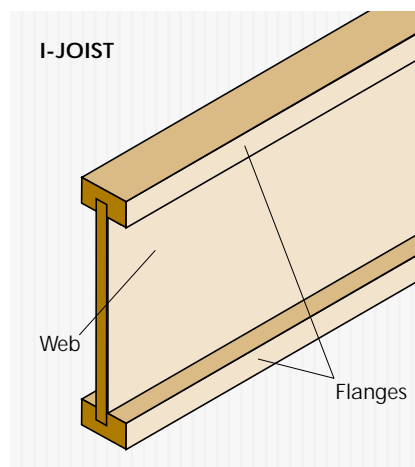

Impact Insulation Class

Values which rate the capacity of floor assemblies to control impact noise such as footfalls. FHA requirements (and some local building codes) specify minimum acceptable ratings.

Impact Noise Rating

Values for floor assembly impact sound transmission, now replaced by IIC classification.

Inner Plies

All plies of a plywood panel except face and back.

INR

See **IMPACT NOISE RATING**.

Interior Glue

A moisture-resistant, but not waterproof, adhesive used in the manufacture of some plywood panels. See also **EXTERIOR GLUE**, **INTERMEDIATE GLUE** and **EXPOSURE DURABILITY CLASSIFICATION**.

Interior

PS 1 exposure durability term for plywood manufactured for indoor use or construction subjected to only temporary moisture. See **EXTERIOR** and **EXPOSURE DURABILITY CLASSIFICATION**.

Intermediate Glue

An adhesive bonding some PS 1 panels which has a moisture resistance midway between interior and exterior glues. Panels bonded with intermediate glue are comparable with those designated under APA performance standards as Exposure 2. See **EXPOSURE DURABILITY CLASSIFICATION**.

J

Jointed Core

Core veneer that has had edges machined square. Gaps between pieces of core shall not exceed 3/8 inch, and the average of all gaps in the panel shall not exceed 3/16 inch.

Joist

Horizontal framing member of a floor, ceiling or flat roof. Wood structural panels are commonly used for subflooring and underlayment or single-layer flooring (APA RATED STURD-I-FLOOR) over floor joists. APA RATED SHEATHING is typically used over roof joists.

K

Kerf

A slot made by a saw; the width of a saw cut.

Kiln-Dried

Wood dried in ovens (kilns) by controlled heat and humidity to specified limits of moisture content. Veneers are kiln dried before lay-up. See also SEASONING.

Knot

Natural growth characteristic of wood caused by a branch base imbedded in the tree trunk.

Knothole

Void produced when a knot drops out of veneer.

L

Lap

To position adjacent objects so that one surface extends over the other. Term may designate a **lap siding** technique, in which each panel or piece overlaps the edge of the next lower panel. A **shiplap joint** unites two panels when half the thickness of each is cut away so that the two pieces fit together with outer faces flush.

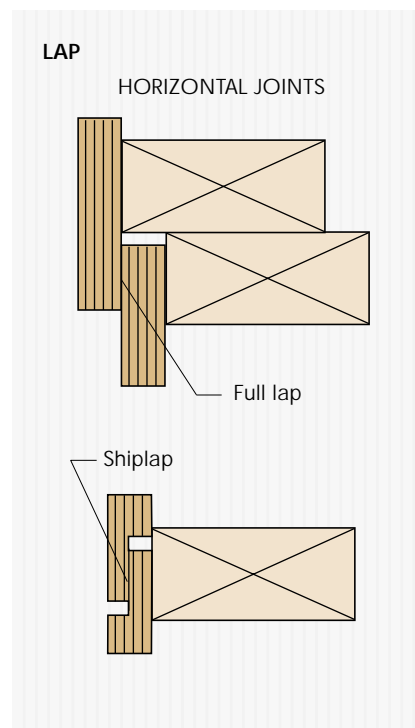

Layer

In plywood a layer consists of one or more adjacent plies having the wood grain in the same direction. For instance, four ply panels always have three layers with both core plies at right angles to the faces. These two plies are one layer and each face is another. In composite panels, the reconstituted wood portion is one layer and each face is another. See PLY.

Lay-Up

The step in wood structural panel manufacture in which veneers or reconstituted wood layers are “stacked” in complete panel “press loads” after gluing and before pressing. Also the construction of the panel.

Live Loads (L.L.)

See LOADS.

Loads

The weight or pressure a structure carries or sustains, which must be considered in planning a building. **Uniform loads** are evenly distributed over a large area, usually the entire surface of a panel. **Concentrated loads** are applied over a very small area (for example, by a piano leg). **Dead loads** are stationary, permanent loads; that is, the weight of all the material used in construction of the building (or section). **Live loads** are planned loads the structure must carry under normal conditions, such as people or furniture and equipment, that would be moved across the structure’s surface. These loads are generally assigned by the building code for the type of structure; for example, a heavy-equipment storage warehouse, a house or an office building. Live loads are generally considered to be uniform loads.

Lumber Core

Plywood manufactured with a core composed of lumber strips. The face and back (outer) plies are veneer.

M

Marine Grade

Plywood panels manufactured with the same glue-line durability requirements as other Exterior panels but with more restrictive veneer quality and manufacturing requirements. The grade is particularly suitable for marine applications where bending is required, as in boat hulls.

MARINE • A-A • EXT-APA • 000 • PS 1-95

MDO

See MEDIUM DENSITY OVERLAY.

Medium Density Overlay

Plywood finished with an opaque resin-treated fiber overlay to provide a smooth surface ideal as a paint base. Recommended for siding and other outdoor applications, and for built-ins, signs and displays, furniture, etc. Available without grooving, with V-grooves, or in T 1-11 or reverse board-and-batten grooving. See also HIGH DENSITY OVERLAY (HDO) and APA RATED SIDING.

Miter Joint

A joint formed by fitting together two pieces of lumber or panels that have been cut off at a 45° angle.

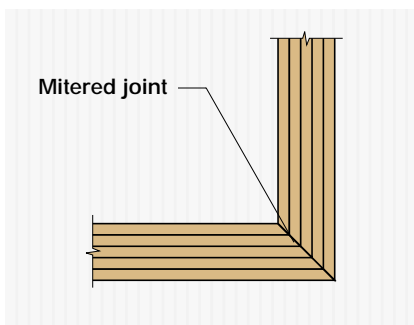

Model Code

A building code developed by a regional federation of building officials. These are continually reviewed and updated by committees of building officials. Model codes in the United States are the Uniform Building Code (UBC), published by the International Conference of Building Officials; the Standard Building Code (SBC), published by the Southern Building Code Congress International; and the National Building Code (NBC), published by the Building Officials and Code Administrators International. Members of these three code organizations comprise the National Evaluation Service. See NATIONAL EVALUATION SERVICE.

Moisture Retarder

See VAPOR RETARDER.

N

Nails

Nails commonly used for residential construction include:

Common and box nails: 16 penny (d) common and box, for general framing. 8d and 10d common and box nails, for toenailing. 6d and 8d common and box nails, for subfloor, wall and roof sheathing. Size depends on thickness of wood structural panel sheathing.



Scaffold nails: 8d and 10d most common, for scaffolds, bracing and any temporary fastening that must later be removed.



Siding nails: Nonstaining nails of size specified for siding thickness.



Casing and finish nails: 4d, 6d and 8d most common, for exterior and interior trim and installation of siding and paneling where large nailheads should not show.



Roofing nails: A special type, commonly available. Size depends on thickness of roofing and deck material.

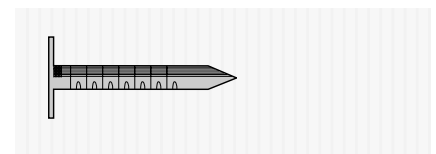

Drywall nails: 4d to 6d size depends on drywall thickness; for 1/2-inch drywall use 4d drywall nails.



For underlayment and finish floor:

Special nail types with greater holding power than ordinary varieties are also available. For hardwood strip flooring, use either 8d hardwood nails or 2-1/2-inch hardened, spiral-threaded (screw-shank) nails. For 1/2-inch and thinner Underlayment grade plywood (over subflooring), use 3d ring-shanks. For 19/32 through 3/4-inch Sturd-I-Floor panels, use any of the 4d deformed-shank nails illustrated below.

For 1/4-inch panels use 3/4-inch or 1-inch brads, 3d finish nails, or (if no objection to heads showing) 1-inch blue lath nails. For exterior application, use galvanized or coated nonstaining nails or fasteners.

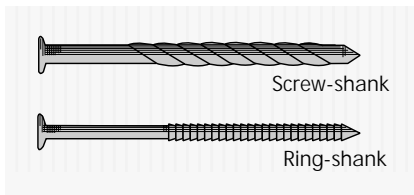

Predrilling is occasionally necessary in careful work where nails must be very close to panel edges. Select a drill bit of slightly smaller diameter than the nail to be used.

Space nails about 6 inches apart for most work. Closer spacing is necessary only with thin panels which might otherwise buckle slightly between nails.

Nail-Glued

See GLUE-NAILED.

Nail Popping

Flooring nails occasionally appear to “pop” up so that nail head impressions are visible on the surface of the finished floor covering. Shrinkage of floor joist away from the nail shank after installation exposes the head. When floor members are dry, make sure fasteners are flush with or below floor surface just prior to installation of thin floor covering such as tile, linoleum or vinyl. Fasteners should be set if green framing will present nail popping problems upon drying. **Do not fill nail holes.**

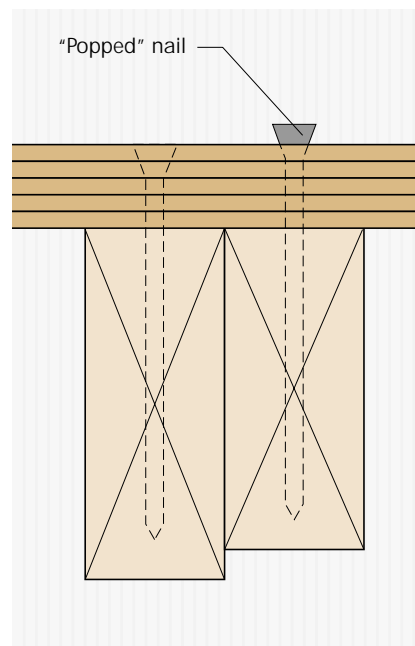

National Evaluation Service (NES)

An arm of the Council of American Building Officials sponsored jointly by the three major American model code organizations – the International Conference of Building Officials (ICBO); the Southern Building Code Congress International (SBCCI); and the Building Officials and Code Administrators International (BOCA). NES studies applications for new products, and publishes evaluation reports recommending approval by its three constituent members. See MODEL CODE.

NES

See NATIONAL EVALUATION SERVICE.

Noise-Rated Systems

Construction designed to reduce sound transmission. Various plywood construction systems tested both in laboratories and buildings meet or exceed requirements.

Nominal Dimension

Full “designated” dimension. For example, a nominal 2 inch by 4 inch stud may measure 1-1/2 inch x 3-1/2 inch when surfaced. It is a commercial size designation, subject to acceptable tolerances. See also SIZED FOR SPACING.

Noncertified

Structural panels not included in Product Standard PS 1, or covered under various Performance Standards, and which may bear the mark of the manufacturer rather than a recognized testing agency, such as APA.

O

O & ES

Oiled and edge-sealed. Surfaces of concrete form panels are lightly coated with oil and the edges sealed **if** specified.

On-Center (O.C.)

On-center spacing, meaning the distance from the center of one structural member to the center of the adjacent member, as in the spacing of studding, joists, rafters, nails, etc. See also CLEAR SPAN.

Open Defects

Irregularities such as splits, open joints and knotholes that interrupt the smooth continuity of veneer.

Oriented Strand Board (OSB)

Wood structural panels manufactured from reconstituted, mechanically oriented wood strands bonded with resins under heat and pressure. Oriented strand material may be produced as the center layer of composite panels, or may be cross-laminated in layered panels. See also APA PERFORMANCE RATED PANELS.

Overlaid Plywood

Plywood panels with factory-applied, resin-treated fiber faces on one or both sides. Term may also apply to metal and other overlaid panels. See HIGH DENSITY OVERLAY (HDO) and MEDIUM DENSITY OVERLAY (MDO).

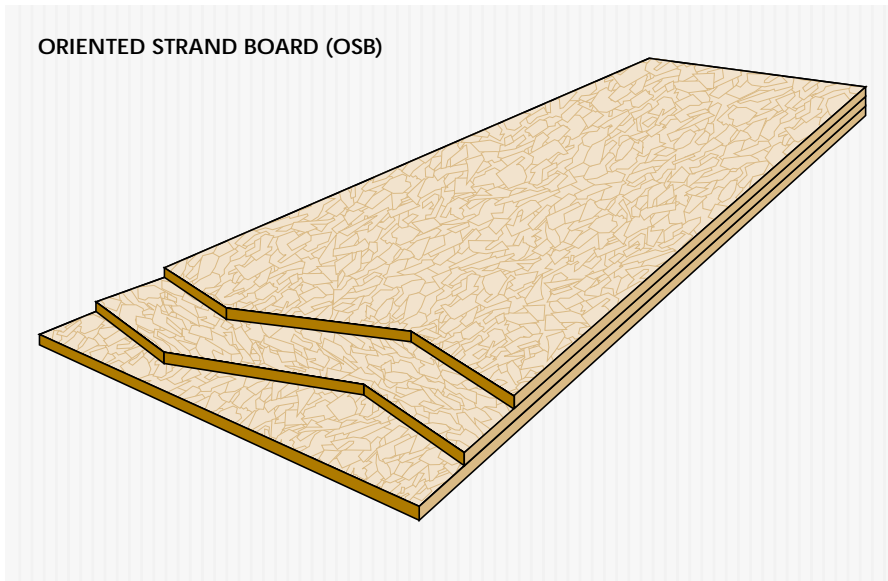

P

P & TS

Plugged and touch-sanded face of a plywood or composite panel.

Paints

See FINISHES.

Panel Clip

Specially shaped metal device for supporting panel edges to reduce differential deflection in roof construction.

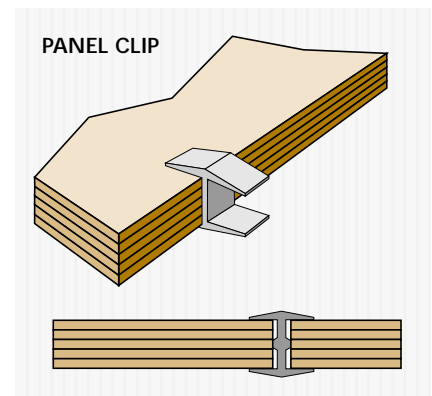

Panel Spacing

The gap left between installed panels in a structure. Panels in floor, wall or roof deck construction should be spaced to allow for any possible expansion due to changing moisture absorption levels. Proper spacing helps prevent buckling and warping. APA spacing recommendations are:

Panel Type	Edge	End
APA Rated Sheathing	1/8	1/8
APA Rated Siding	1/8	1/8
APA Rated Sturd-I-Floor	1/8	1/8
Underlayment	1/32	1/32

See also SIZED FOR SPACING.

Paneling

Wood panels joined in a continuous surface, especially decorative panels for interior wall finish. Textured plywood in many varieties is often used as interior paneling either in full wall sections or accent walls. See APA RATED SIDING for textured plywood used as paneling.

Panelized Construction

Building components fabricated in wall, floor, or roof sections, etc., to be assembled into a completed structure at the building site. Panelized construction speeds erection and cuts on-site labor costs. It offers the high quality available through controlled factory production and inspection procedures.

Patch

See REPAIRS.

PCUF

See PLUGGED CROSSBAND UNDER FACE.

Peeler Log

A specially selected softwood log used to produce veneer. Peelers are debarked, then lathe-turned against a long knife blade which slices off a thin, continuously unwinding sheet of veneer then clipped to size, dried, graded, repaired and laminated into plywood panels.

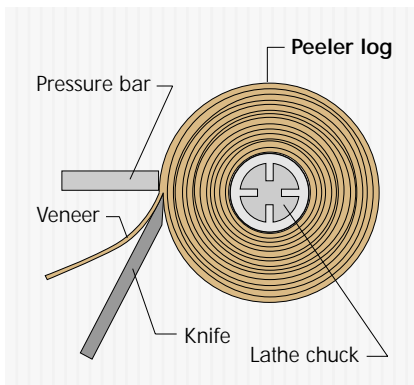

Performance Rated Panels®

See APA PERFORMANCE RATED PANELS.

Performance Standard

A standard applying to panels such as APA RATED SHEATHING, APA RATED STURD-I-FLOOR and APA RATED SIDING. Panels manufactured to meet APA performance standards must satisfy rigorous, exacting performance criteria. See also PRODUCT STANDARD and APA PERFORMANCE RATED PANELS.

Permanent Wood Foundation

See WOOD FOUNDATION.

PIRF (Perimeter-Insulated Raised Floor System)

Crawl space foundation-floor system where insulation is applied only to the inside of the perimeter foundation stem wall. The resulting system saves construction costs and gives superior energy performance.

Pitch Streak

A localized accumulation of pitch in wood cells in a more or less regular streak.

Plastic Overlaid

See MEDIUM DENSITY OVERLAY and HIGH DENSITY OVERLAY.

Plate

In wood frame construction, the horizontal lumber member on top and/or bottom of the wall studs which ties them together and supports the studs or rafters.

Plug

See REPAIRS.

Plugged Core

Inner ply construction of solid C-Plugged veneer pieces. Gaps between pieces of core should not exceed 1/2-inch per Product Standard PS 1. See JOINTED CORE.

Plugged Crossbands Under Face (PCUF)

A designation denoting a SANDED PANEL of special construction, making it suitable for use as an UNDERLAYMENT, for example A-C (PCUF).

Ply

A single veneer in a panel.

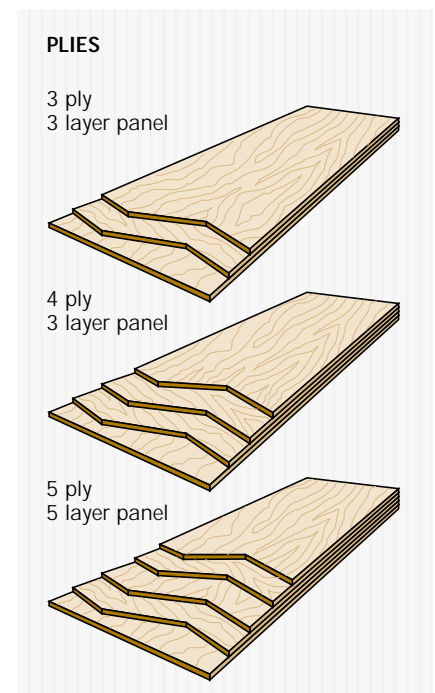

Plyform

See B-B PLYFORM.

Plyron®

A plywood panel manufactured with a hardboard face for an extra-smooth painting and tough wearing surface. May be Exposure 1 or Exterior. Exposure 1 PLYRON is available with a standard, tempered or treated hardboard surface and is manufactured of D-grade veneer except the ply directly under the hardboard surface, which must be C-grade. Exterior PLYRON is available with a tempered or treated surface and is manufactured with C-grade plies throughout. PLYRON is ideal for work surfaces, fixtures, built-ins, cabinets and doors, underlayment and industrial uses.

PLYRON • EXT • APA • 000

PLYRON • EXPOSURE 1 • APA • 000

Popping

See NAIL POPPING.

Prefabricated

In housing, all parts constructed or fabricated at the factory so that final construction only involves assembling and uniting standard parts at the job site. Commonly abbreviated as “prefab.” See PANELIZED CONSTRUCTION.

Prefinished

A ready-to-use panel with factory-applied finish – paint, overlays or coatings.

Preframed

Panelized building in which wall, floor or roof sections are framed and sheathed at the factory.

Preprimed

A panel with a factory-applied primer or undercoat needing only final finish after installation.

Preservatives

Products which prevent wood deterioration due to weather exposure, excessive moisture or insect attack. Treatments range from chemical pressure-impregnation, as for wood foundations, to application of paints or sealers.

Pressure-Preservative Treated

Wood treated with preservative by pressure-injecting treating solutions into wood cells. See WOOD FOUNDATION.

Primer

An undercoat applied to bare wood as a sealer and base for paint. See FINISHES.

Product Standard

An industry product manufacturing or performance specification. APA trademarks carrying the PS 1 or PS 2 mark are identification by the manufacturer that the panel has been produced in conformance with U.S. Product Standard PS 1 for Construction and Industrial Plywood or Voluntary Product Standard PS 2, Performance Standard for Wood-based Structural-Use Panels. PS 1 is a detailed manufacturing specification and alternate performance standard developed cooperatively by the softwood plywood industry and the U.S. Department of Commerce. PS 1 requirements and a supplementary set of APA specifications help ensure that plywood manufactured by APA member mills maintains its consistently high quality. PS 2 is a similar standard, without the detailed manufacturing specification, that relies on performance testing to assure that the structural panels meet realistic, rigorous standards.

PRP®

See APA PERFORMANCE RATED PANELS.

Purlin

Subframing which supports roof decking where larger beams are main structural supports.

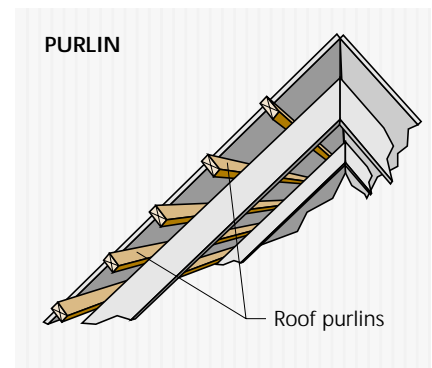

PWF

Abbreviation for Permanent Wood Foundation. See WOOD FOUNDATION.



Quality Inspection And Testing

Testing program administered by APA to ensure quality levels in member mills equal to or exceeding those prescribed by U.S. Product Standard PS 1, PS 2 or APA's own performance standards. The program is based on scientific random sampling. If quality levels are not maintained, APA trademark privileges may be withdrawn until compliance is restored.

R Value

A measurement of thermal resistance, or ability to retard heat transmission. Used to compute insulating effectiveness.

Rabbet Joint

A joint formed by cutting a groove in the surface or along the edge of a board, plank or panel to receive another piece.

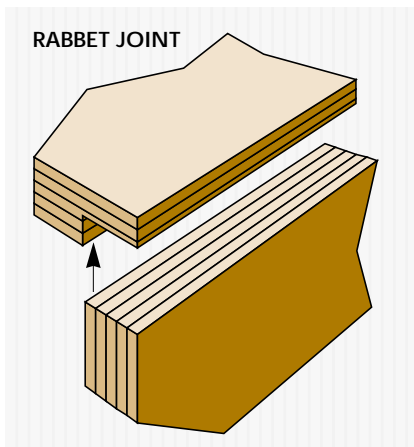

Racking Resistance

The ability of a panel to resist forces in the panel's plane tending to distort it from its rectangular shape.

Rafter

Sloping supporting member of a roof immediately beneath the sheathing.

Raised Grain

See GRAIN RAISE.

Rated Sheathing

See APA RATED SHEATHING.

Rated Siding

See APA RATED SIDING.

Repairs

Any patch, plug or shim in a veneer. A **patch** is a sound wood insert to replace a defect in veneer. "Boat" patches are

oval shaped with sides tapering to points or small rounded ends. "Router" patches have parallel sides and rounded ends. "Sled" patches are rectangular with feathered ends.

A **plug** may be a circular or dogbone shaped wood patch, or a synthetic filler of fiber and resin to fill openings and provide a smooth, level, durable surface. A **shim** is a long narrow wood or synthetic repair not more than 3/16 inch wide. Various other shapes of plugs or patches may be encountered. PS 1 specifies sizes, shapes and numbers of allowable patches in given veneer grades.

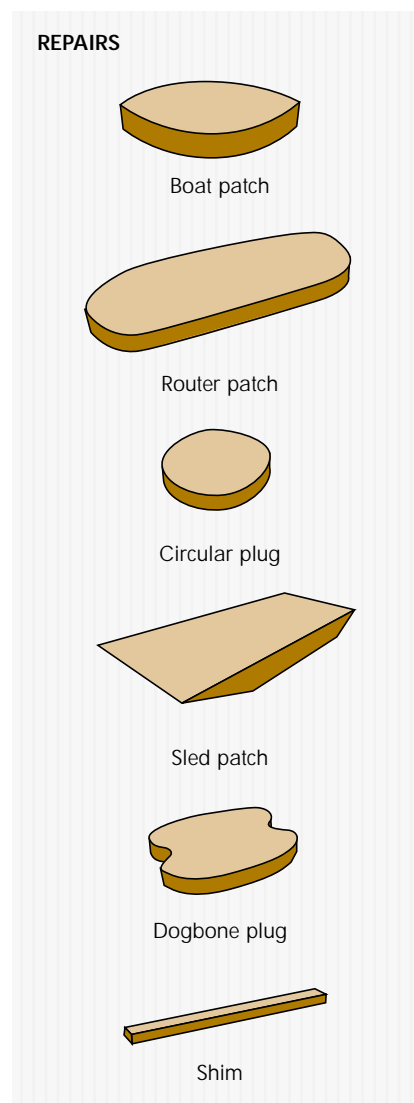

Resawn

See ROUGH SAWN.

Resilient Floor Covering

Any of the vinyl or asphalt-base floor coverings (tile or sheet) with enough "give" to resist deformation or denting from dropped objects. Resilient floor coverings installed over APA STURD-I-FLOOR or UNDERLAYMENT panels with "sanded face" provide smooth, stiff floors for comfortable walking.

Reverse Board And Batten

An APA 303 Siding surface treatment. Deep, wide grooves cut into textured siding surfaces during manufacture create striking, sharp shadow lines. See APA RATED SIDING.

Ridge Beam

The top horizontal member of a sloping roof, against which the ends of the rafters are fixed or supported.

Rigid Frame

Structural member functioning like an arch, comprised of studs and rafters fastened with plywood gussets. Rigid frame construction eliminates the need for ceiling or tie members.

Ripping

Sawing wood in the direction of the grain. See CROSS CUTTING.

Rotary Peel

See PEELER LOG.

Rough Sawn

A decorative APA Siding treatment imparting a rough, rustic appearance by saw-scoring the surface of a panel during manufacture. Same as resawn. See APA RATED SIDING.

Router Patch

See REPAIRS.

Sanded Panels

Interior, Exposure 1 or Exterior plywood panels factory-sanded for applications where smoothness and appearance are important. These panels – with N, A or B-grade faces – are ideal for furniture, cabinets, doors, fences, signs, etc. Sanded panels save time because they may be finished with little or no preparation.

Sandwich Panel

See Structural Insulated Panel.

Sapwood

Living wood of pale color near the outside of a log. Under most conditions, sapwood is more susceptible to decay than heartwood.

Scarf Joint

An angled or beveled joint in plywood splicing pieces together. The length of the scarf is 5 to 12 times the thickness.

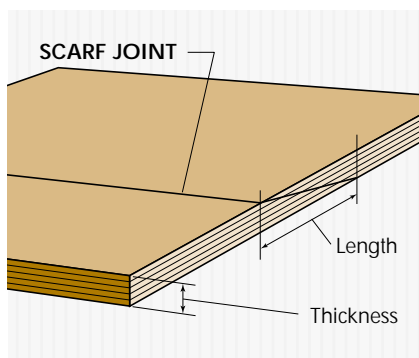

Screws

Use flat head wood screws for attaching wood structural panels where nails will not provide sufficient holding power. Sizes shown below are minimum; use longer screws where work permits. Lubricate screws with soap if they are hard to drive. If used for sheathing, use same spacing as recommended for nails.

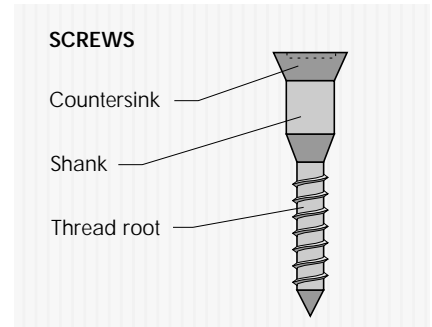

SCREW SIZES

Plywood Thickness (in.)	Screw Length (in.)	Screw Size	Drill Size for Shank (in.)	Drill Size for Root of Thread (in.)
23/32	1-1/2	#8	11/64	1/8
19/32	1-1/4			
15/32	1-1/4	#6	9/64	3/32
3/8	1	#4	7/64	1/16

Seasoning

Removal of moisture from wood to improve its serviceability, usually by air drying – drying by air exposure without artificial heat – or kiln drying – drying in a kiln with artificial heat. Plywood veneers are seasoned before lay-up and gluing into panels.

Shear Wall

See DIAPHRAGM.

Sheathing

The structural covering, usually of wood panels or boards, on the outside surfaces of framing. It provides support for construction, snow and wind loads and backing for attaching exterior facing materials such as wall siding, roof shingles or underlayment in double-layer floors. APA RATED SHEATHING is recommended for conventional applications. See APA RATED SHEATHING.

Shim

See REPAIRS.

Shiplap

Jointing in which ends or edges are notch-milled to overlap and form a rabbet joint.

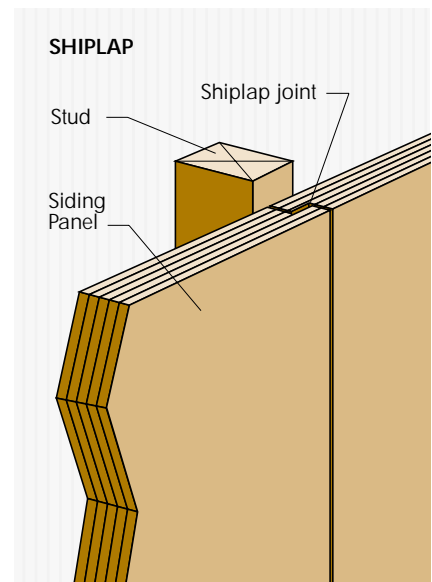

Shop Cutting Panel

Panel rejected as not conforming to grade requirements defined in the Product Standard. Panel identification, a separate mark that does not mention the Standard, reads: “Shop Cutting Panel – All Other Marks Void.” Normally a “shop” panel’s defect may be eliminated by cutting the panel into smaller pieces for applications not governed by building codes.

Siding

See APA RATED SIDING.

Sill Plate

The lowest framing member of a structure, resting on the foundation and supporting the floor system and the uprights of the frame.

Single Floor

A single-layer wood structural panel flooring system combining subflooring and underlayment. See APA RATED STURD-I-FLOOR.

Single Wall

See APA STURD-I-WALL.

Sized For Spacing

A notation in APA RATED SHEATHING and RATED STURD-I-FLOOR trademarks indicating panels may be trimmed during manufacture to length and width tolerances of +0, -1/8 inch. This trimming is designed to encourage proper panel spacing. See PANEL SPACING.

Sled Patch

See REPAIRS.

Soffit

The underside of the roof overhang. Wood structural panels are often used as finishing materials for soffits.

Softwood

Wood of the coniferous or needleleaved trees – pine, fir, spruce, hemlock – as distinct from the hardwood of the deciduous or broadleaved trees – oak, ash, maple, walnut. The term has only a general reference to actual wood hardness. Construction and industrial ply-

wood and other panel products may use either variety, but are more commonly manufactured of softwoods. See HARDWOOD.

Solid Core

See PLUGGED CORE.

Sound Transmission Class

See STC.

Spacing

See PANEL SPACING.

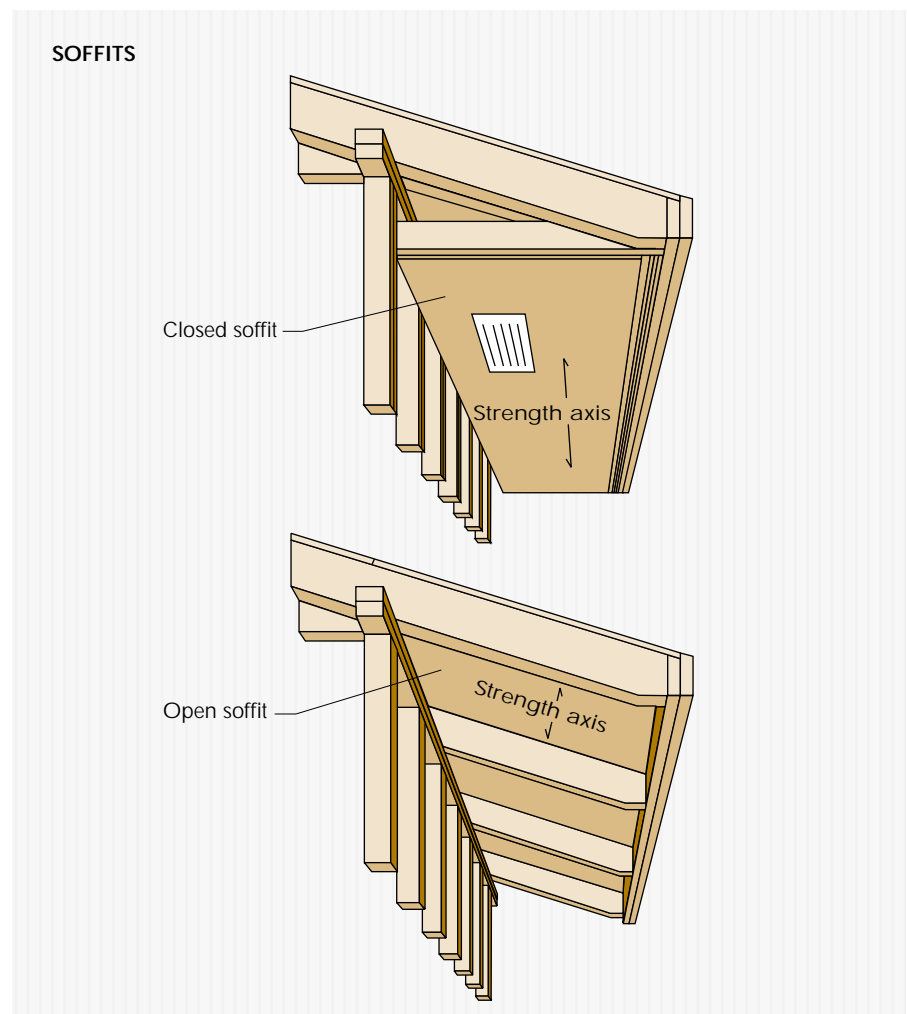

Span Rating

The number that appears in the trademark on APA RATED STURD-I-FLOOR, APA RATED SHEATHING and APA RATED SIDING panels. Two numbers separated by a slash (e.g., 24/0, 32/16, 48/24) appear on APA RATED SHEATHING. The left-hand number is the maximum recommended center-to-center spacing of supports in inches when the panel is used for roof sheathing with long dimension across supports (unless the strength axis is otherwise identified). The right-hand number is the maximum center-to-center spacing of supports in inches when the panel is used for subflooring with long dimension across supports. When a panel is applied as wall sheathing, a rating of 24 or more means the panel can be applied to studs spaced 24 inches on center. A rating less than 24 means the panel can be applied to studs spaced 16 inches on center. APA RATED SHEATHING panels may be applied as wall sheathing either vertically or horizontally. In all cases the panel should be applied continuous over three or more supports.

The single-number Span Ratings on APA RATED STURD-I-FLOOR panels (16, 20, 24, 32 or 48 oc) denote maximum recommended center-to-center spacing between floor joists with panels laid with long dimension across three or more supports.

Similarly, the single-number Span Ratings on APA RATED SIDING panels are the maximum recommended center-to-center spacings of studs (16 or 24 o.c.) when the panel is applied vertically direct to studs (or over nonstructural wall sheathing such as fiberboard, gypsum or rigid foam insulation sheathing). All RATED SIDING panels may be

applied horizontally direct to studs spaced 16 or 24 inches on center, provided horizontal joints are blocked. When RATED SIDING is used over APA RATED SHEATHING or lumber, the Span Rating refers to the maximum recommended spacing of vertical rows of nails rather than studs.

Panels with a given Span Rating may be manufactured in more than one thickness, and vice versa, because of varying panel compositions and configurations.

Species Group

See GROUP NUMBER.

Stains

See FINISHES.

STC

Sound Transmission Class. A measure of the ability of a wall or floor assembly to reduce noise transmission.

Stressed-Skin Panel

An engineered structural panel assembly for roof deck or floor applications built of plywood sheets glued to framing members. The quick-covering assembly has greater load carrying capacity than would its individual members if installed separately.

Stringer

A lumber member supporting a series of cross members. Frequently applied to stair supports.

Structural I

Unsanded grade for use where shear and cross-panel strength properties are of maximum importance, such as panelized roofs and diaphragms. All plies in Structural I plywood panels are special improved grades and panels marked PS 1 are limited to Group 1 species. Other panels marked Structural I Rated qualify through special performance

testing. Manufactured with Exterior or Exposure 1 durability classifications. See also APA RATED SHEATHING.

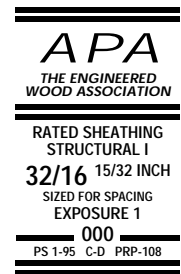
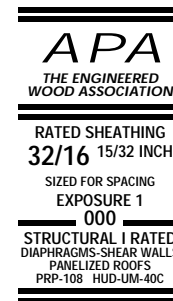

Structural Insulated Panel

A section of layered construction made up of high-strength structural wood panel faces, or “skins,” attached to both sides of low-density core materials such as plastic foam or honeycomb paper fillers. Sometimes referred to as sandwich panel or stress-skin panel.

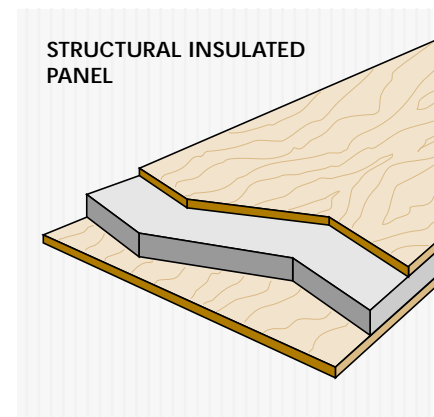

Stud

The basic vertical framing members of walls, usually 2x4s. Studs are traditionally spaced 16 inches on center, sometimes 24 inches as in the Engineered 24" Framing System. See SPAN RATING.

Sturd-I-Floor

See APA RATED STURD-I-FLOOR.

Sturd-I-Wall

See APA STURD-I-WALL.

Subflooring

APA RATED SHEATHING panels applied directly over floor joists which will receive an additional underlayment layer. Wood structural panels provide strength and stiffness. They also reduce the number of floor joints as compared with board sheathing. See also UNDERLAYMENT.

Swelling

See EXPANSION and PANEL SPACING.

Synthetic Repairs

See REPAIRS.



T-Beam

Beam resembling a “T” in cross section. Several side-by-side T-beams acting as a unit may form a floor. This principle accounts for the increased stiffness of glued floors.

Telegraphing

Show-through on a smooth overlaid plywood panel surface of underlying grain or defects.

Testing Agency

See APA – *The Engineered Wood Association* and QUALITY INSPECTION AND TESTING.

Texture 1-11®

APA trade name for a special RATED SIDING panel 19/32 inch or thicker with 3/8-inch-wide vertical grooves typically spaced 4 or 8 inches on center. Shiplapped edges maintain pattern continuity when installed. See APA RATED SIDING.

Textured Plywood

Panels with a variety of machined surface textures. Available as Exterior with fully waterproof glueline for siding and other outdoor uses and for interior wall paneling. See APA RATED SIDING.

303® Specialty Siding

See APA RATED SIDING.

Tongue-And-Groove Joint

A system of jointing in which the rib or tongue of one member fits exactly into the groove of another. A specially designed APA – *The Engineered Wood Association* tongue-and-groove panel

edge joint is particularly efficient in transferring the load across the joint. Some APA RATED STURD-I-FLOOR T&G panels measure 47-1/2 inches across the face.

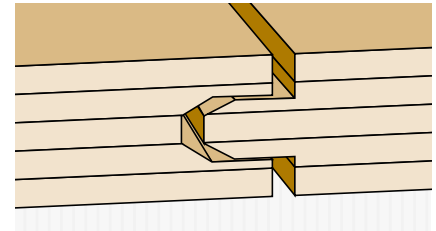

Touch-Sanded Panels

Wood structural panels “sized” to uniform thickness by light surface sanding during manufacture. Sander skips are admissible. Normally applied to C-Plugged faces.

Trademark

See APA TRADEMARK.

Truss

A combination of members usually arranged in triangular units to form a rigid framework for supporting loads over a span. Parallel chord trusses are also used for floor and roof supports.

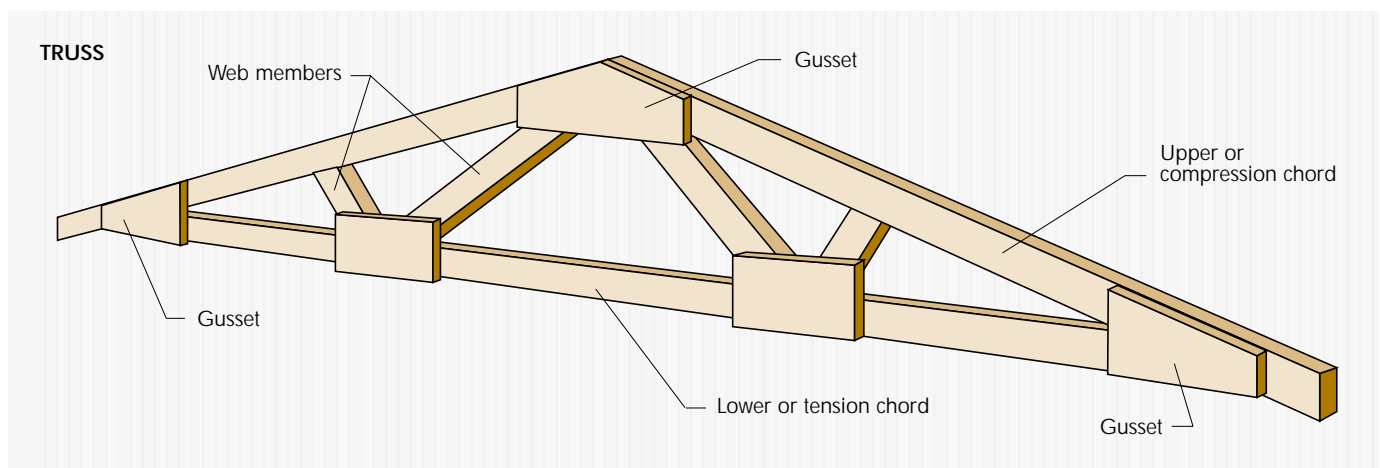

2-4-1®

Synonymous with APA RATED STURD-I-FLOOR 48 oc. 2-4-1 is a 1-1/8-inch-thick all-veneer panel with an Exposure 1 durability classification. It's designed for single-floor applications over 2x supports spaced 32 inches on center or over 4x supports 48 inches on center. 2-4-1 may also be used in Heavy Timber roof construction. Available as specified with square edge or tongue-and-groove joint. See APA RATED STURD-I-FLOOR.



Underlayment

A material applied over subflooring and directly beneath nonstructural finish flooring, such as tile or carpeting. Wood panel underlayment provides a smooth surface for finish flooring and excellent puncture and indentation resistance. See also SUBFLOORING, PLUGGED CROSSBAND UNDER FACE and UNDERLAYMENT GRADE.

Underlayment C-C Plugged Exterior

An Exterior underlayment panel with a touch-sanded C-Plugged face ply. Common uses include underlayment in conditions of severe moisture or humidity (bathrooms, kitchens), refrigerator or controlled atmosphere storage rooms, exterior balconies and decks, pallet bins, tanks, boxcar and truck floors and linings, and open soffits.

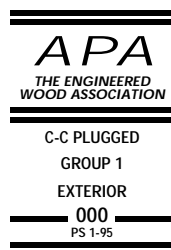

Underlayment Grade

PS 1-designated, touch-sanded panels designed as a base for finish flooring such as carpeting (and tile or linoleum when specified with a sanded face) and installed over structural subflooring such as APA RATED SHEATHING. These panels are manufactured with either interior or exterior glue – the latter designed for applications subject to long construction delays or similar moisture exposure. Underlayment panels are identified by Group number.

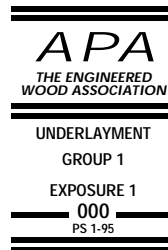

Unsanded Panels

Interior, Exposure 1 or Exterior sheathing grade panels designed for utility applications and left unsanded for greater stiffness, strength and economy.

Vapor Retarder

A material (such as plastic film) which controls moisture transmission through walls and other building elements. Often

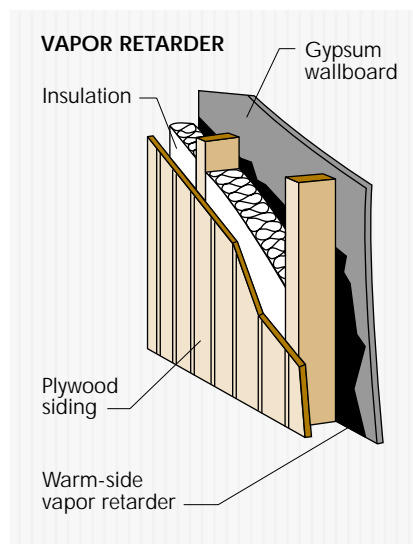

combined with insulation to control condensation. A vapor retarder should be installed on the warm side of walls.

Veneer

A thin sheet of wood laminated with others under heat and pressure to form plywood, or used for faces of composite panels. Also called ply.

Veneer Grade

The standard grade designations of softwood veneer used in panel manufacture. The six grades are:

N Special order “natural finish” veneer. Select all heartwood or all sapwood. Free of open defects. Allows some repairs.

A Smooth and paintable. Neatly made repairs permissible. Also used for natural finish in less demanding applications.

B Solid surface veneer. Router or sled repairs and tight knots permitted.

C Improved C veneer with splits limited to 1/8 inch in width and knotholes and borer holes limited to 1/4 inch by 1/2 inch.

C Knotholes to 1 inch. Occasional knotholes 1/2 inch larger permitted providing total width of all knots and knotholes within a specified section does not exceed certain limits. Limited splits permitted. Minimum veneer grade permitted in Exterior plywood.

D Permits knots and knotholes to 3 inches in width, and 1/2 inch larger under certain specified limits. Limited splits permitted.

Void

See CORE GAP.

W

Waferboard

Panels manufactured from reconstituted wood wafers, as opposed to strands, bonded with resins under heat and pressure. See also ORIENTED STRAND BOARD.

Wainscot

The wooden lining of the lower part of an interior wall.

Waler

Horizontal timbers used to brace concrete form sections.

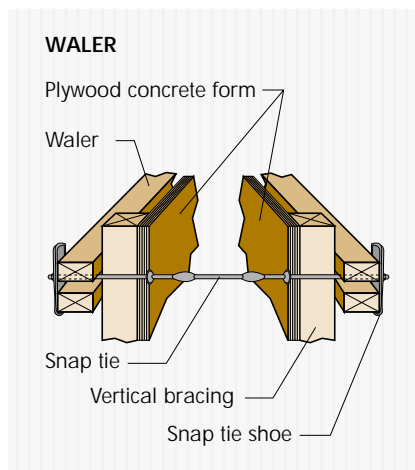

Warping

Bending or twisting from a straight line. An improperly seasoned piece of lumber may warp when exposed to heat or moisture. To reduce the possibility of warping, protect wood panels from dampness or moisture and follow APA spacing recommendations. Painting and water-repellent dips will minimize moisture absorption. Sealing all edges and back-priming also reduces the chances of warping in cabinet doors. See PANEL SPACING.

Water Repellents

Wood preservatives with water-resistant properties.

Web

See BOX BEAM and TRUSS.

Wicking

The tendency of wood to draw moisture up through its cells by capillary action in the direction of the grain.

Wood Foundation

A residential and light frame foundation system utilizing pressure-preservative-treated plywood panels and wood framing in place of poured concrete footings and masonry or poured concrete walls. The system is commonly known as the Permanent Wood Foundation (PWF). The system can often be installed on a prepared site in less than half a day in nearly any weather, speeding construction and reducing costs. The PWF is also applicable to crawl-space foundation construction.

Z

Z Flashing

A Z-shaped piece of galvanized steel, aluminum or plastic installed at horizontal joints of panel siding to prevent water from entering wall cavity.

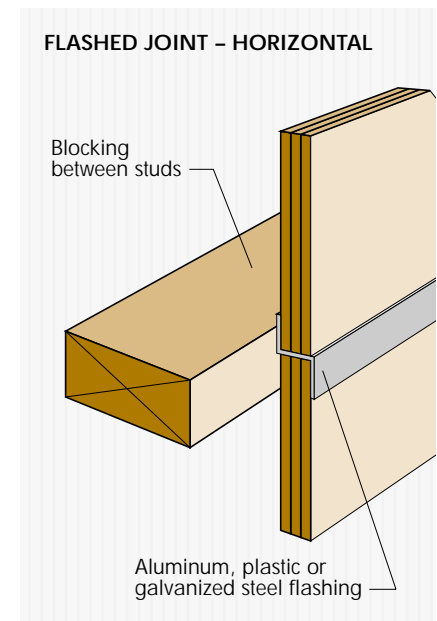

The product use recommendations in this publication are based on APA – *The Engineered Wood Association's* continuing programs of laboratory testing, product research, and comprehensive field experience. However, because the Association has no control over quality of workmanship or the conditions under which engineered wood products are used, it cannot accept responsibility for product performance or designs as actually constructed. Because engineered wood product performance requirements vary geographically, consult your local architect, engineer or design professional to assure compliance with code, construction, and performance requirements.



PANEL HANDBOOK & GRADE GLOSSARY

G L O S S A R Y

We have field representatives in most major U.S. cities and in Canada who can help answer questions involving APA trademarked products. For additional assistance in specifying APA engineered wood products, get in touch with your nearest APA regional office. Call or write:

WESTERN REGION

7011 So. 19th St. ■ P.O. Box 11700
Tacoma, Washington 98411-0700
(253) 565-6600 ■ Fax: (253) 565-7265

EASTERN REGION

2130 Barrett Park Drive, Suite 102
Kennesaw, Georgia 30144-3681
(770) 427-9371 ■ Fax: (770) 423-1703

U.S. HEADQUARTERS AND INTERNATIONAL MARKETING DIVISION

7011 So. 19th St. ■ P.O. Box 11700
Tacoma, Washington 98411-0700
(253) 565-6600 ■ Fax: (253) 565-7265



www.apawood.org

PRODUCT SUPPORT HELP DESK

(253) 620-7400
E-mail Address: help@apawood.org

(Offices: Antwerp, Belgium; Bournemouth, United Kingdom; Hamburg, Germany; Mexico City, Mexico; Tokyo, Japan.) For Caribbean/Latin America, contact headquarters in Tacoma.

The product use recommendations in this publication are based on APA – The Engineered Wood Association's continuing programs of laboratory testing, product research, and comprehensive field experience. However, because the Association has no control over quality of workmanship or the conditions under which engineered wood products are used, it cannot accept responsibility for product performance or designs as actually constructed. Because engineered wood product performance requirements vary geographically, consult your local architect, engineer or design professional to assure compliance with code, construction, and performance requirements.

Form No. X505R/Revised April 1997/0300

A P A

The Engineered Wood Association

