

Caterpillar Performance Handbook

Edition 29

CATERPILLAR[®]

CONTENTS

	Page
Preface	4
Operator and Machine Protection	5
Replacement Parts Warning	7
Nomenclature	8

TRACK-TYPE TRACTORS	1
AGRICULTURAL TRACTORS	2
MOTOR GRADERS	3
EXCAVATORS	4
BACKHOE LOADERS	5
SKIDDERS	6
PIPELAYERS	7
WHEEL TRACTOR-SCRAPERS	8
CONSTRUCTION & MINING TRUCKS/TRACTORS	9
ARTICULATED TRUCKS	10
WHEEL TRACTORS • SOIL/LANDFILL COMPACTORS	11
WHEEL LOADERS	12
TRACK LOADERS	13
INTEGRATED TOOLCARRIERS	14
TELESCOPIC HANDLERS	15
PAVING PRODUCTS	16
ELPHINSTONE UNDERGROUND MINING MACHINES	17
HYDROMECHANICAL WORK TOOLS	18

ENGINES	19
FORMER MODELS	20
OWNING & OPERATING COSTS	21
TIRES	22
MINING AND EARTHMOVING	23
LOGGING AND FOREST PRODUCTS	24
STOCKPILE COAL HANDLING	25
LAND CLEARING	26
WASTE DISPOSAL	27
TABLES	28
INDEX	29

PREFACE

Machine performance must ultimately be measured in unit cost of material moved, a measure that includes both production and costs. Factors bearing directly on productivity include such things as weight to horsepower ratio, capacity, type of transmission, speeds and operating costs. The Performance Handbook considers these factors in detail. There are other less direct machine performance factors for which no tables, charts or graphs are possible. Serviceability, parts availability and operator convenience are examples. In comparing machine performance, all factors should be considered. This Handbook is intended as an aid which, when coupled with experience and a good knowledge of local conditions, can assist in estimating true machine performance.

Many sections of the Handbook include tables or curves showing cycle times or hourly production figures for Caterpillar machines under certain conditions. Statements of conditions always accompany or precede the curves or tables. Before using any performance information in this Handbook, a complete understanding of the qualifying conditions is essential. The data is based on field testing, computer analysis, laboratory research and experience; and every effort has been made to assure their correctness.

However, all such data is based upon 100% efficiency in operation — a status which cannot be achieved continuously even under ideal conditions. Thus, in using such performance and production data, it is necessary to correct the results indicated in the handbook tables by appropriate factors. This allows for the anticipated actual job efficiency, operator efficiency, material characteristics, haul road conditions, altitude and other factors which may reduce performance or production on a particular job.

Methods for estimating machine owning and operating costs vary widely, depending on locality, industry practices, owner preferences and other factors. One method is suggested in the Handbook section on Owning and Operating Costs. When used with good judgment, it has provided reasonably accurate estimates in the past. Included in the Owning and Operating Section are guidelines, based on working conditions, to assist in estimating consumption of fuel and lubricants, tire life and repair costs for Caterpillar machines. However, what one Handbook user regards as “excellent” conditions, another may consider “severe” or “average”, depending on his own experience and basis of comparison. Therefore, these guidelines should be considered only approximations.

Caterpillar Inc. has made every effort to assure that the information contained in this Handbook is accurate and is a fair statement of the results to be achieved in the circumstances indicated. However, because of the many variables involved in estimating the production or performance of earthmoving machinery, their consumption of fuel and lubricants, tire life and repair costs, and the possibility of inadvertent errors or omissions in assembling this data, Caterpillar cannot and does not imply that all data in this book are complete nor that this level of performance will be achieved on a given job.

Specifications shown in this Handbook were current at time of printing. However, due to Caterpillar’s many machine improvement programs, specifications and materials may change without notice. For current specifications relating to a machine’s performance, please refer to the most recent Caterpillar product specification sheet.

Caterpillar Inc.

OPERATOR AND MACHINE PROTECTION

A well trained operator, working under suitable conditions, utilizing a modern, properly-equipped machine provides a machine-operator team capable of giving maximum production. These factors, along with appropriate job site rules and communication procedures, are essential to coordinate people and machines working together. Appropriately protected and maintained machines are less likely to suffer premature component failure or damage, and give operators the confidence and assurance they need to carry out their work. Furthermore, training is not complete until the operator reads, understands and agrees to follow the instructions provided in the Operation and Maintenance Manual included with every Caterpillar machine.

Employers have a duty to provide a safe work place for their employees. The purchaser of a Caterpillar machine has a duty to review his/her particular application and job site for the machine to identify potential hazards inherent to that application or job site. Based on the results of this hazard analysis, the appropriate operator and machine protection configuration can be determined.

Caterpillar designs, builds, and tests its products to ensure the safety of operators, maintenance persons, service persons, and bystanders. Caterpillar provides as standard equipment the appropriate operator and machine protection for most applications. However, particular applications may require additional operator and/or machine protection. Caterpillar offers related options for most such applications. However, there may be very special applications where the Caterpillar Dealer or the Purchaser may want to fabricate, or request Caterpillar to provide, custom or special guarding. Your Caterpillar Dealer can help you with this hazard analysis and guarding configuration process.

I. Operator Training and Protection Practices

Remember that any kind of machine or mechanical device can be hazardous if not kept in good condition, or if operated by careless or improperly trained operators, or if operated in an irresponsible manner.

Listed below are some recommended basic steps that can be broadly applied to most work environments:

- Train operators for the job they are assigned to do. The length and type of training must comply with governmental and local regulations wherever they apply. As an example, machine operators in mining activities must be trained in accordance with Mine Safety and Health Administration (MSHA) regulations. Where specific regulations do not apply, no operator should be assigned to a job until he or she meets the following minimum requirements:
 - Completes proper training to operate the assigned machine and understands that seat belts must be worn whenever seated in operator's compartment.
 - Reads and understands the Operation & Maintenance manual for that machine, and knows that a copy of that manual is stored in the operator's compartment.
 - Reads and understands the EMI (Equipment Manufacturer's Institute), CIMA (Construction Industry Manufacturers Association), or any other furnished manual related to rules for safe machine operation and identification of hazards.
 - Has appropriate personal safety equipment and knows how to use it. This includes such things as hard hat, gloves, safety glasses, hearing protection and safety shoes.
 - Knows what the job requirements are, what other machines are working in the area, and is aware of any hazardous conditions that may arise.
- Be sure operators are alert and in proper physical and mental condition to perform their work assignments safely. No machine should be operated by a person who is drowsy, under the affect of medicines or drugs, suffers blackouts, or is suffering from any physical or mental distraction that could contribute to unsafe operation.

- Maintain proper job conditions and working procedures. Check the job for possible hazards, both above and below ground level. Look for all possible sources of danger to the operator and others in the area. Pay particular attention to conditions which may be hazardous or near the operating limits of the machine: e.g., side slopes, steep grades, potential overloads, etc. Examine the work site for restricted traffic patterns, obstructed views, congestion, etc. Hazardous work conditions should be corrected wherever possible and adequate warnings should be posted when applicable.
- Provide the correct machine to handle the job and equip it properly for the job to provide the necessary operator protection. Check for compliance with all applicable governmental and local regulations. It is the machine owner's or employer's legal responsibility to see that his equipment complies with, and is operated in accordance with, all such requirements.
- Make sure the machine is properly maintained. A walk-around inspection should be performed at the beginning of each shift before the machine is placed in operation. If this inspection reveals any problems that could affect safety, the machine must not be operated until these problems are corrected. Some examples include:
 - Loose, bent or missing grab irons, railings or steps;
 - Worn, cut or missing seat belts (any seat belt over three (3) years old must be replaced regardless of condition);
 - Damaged windows in the operator's compartment;
 - Worn, rubbing or abraded electrical insulation and hoses;
 - Any fluid leaks; and
 - Missing or damaged guards.

It is the machine owner's or employer's responsibility to ensure the machine is properly maintained. Your Caterpillar Dealer will be glad to assist you in selecting and equipping the machine best suited for your job and in providing maintenance for your machines.

II. Machine Modifications

Modifications must not be made to the machine that:

- Interfere with operator visibility;
- Interfere with ingress, egress from the machine;
- Exceed the rated payload or gross combination weight of the machine resulting in overloading the braking and/or steering system or the roll-over protective structure (ROPS) capacity rating (shown on a plate affixed to the ROPS); or
- Place objects in the cab that intrude into the operator's space or that are not firmly fixed into place.

III. Operator-related Equipment Options

Each job presents unique conditions that must be taken into account. Consider direct dangers to the operator as well as all possible sources of distraction that could reduce operator efficiency and increase the chances of costly and dangerous mistakes. Climate-controlled, sound-suppressed cabs, and special exterior lighting are options available from Caterpillar that can address requirements of special working environments.

"Flexible" machines include hydraulic excavators (track-type, wheel-type, and compact), skid-steer loaders, backhoe loaders and integrated tool-carriers. Work tools or any tool used in hazardous applications like demolition and logging, can create a need for special operator guarding. When flying debris from impact, cutting, shearing or sweeping attachments is present, additional protective devices such as a front screen, Falling Object Guarding System (FOGS, includes top & front guarding), thick polycarbonate windshields or a combination of these is recommended by Caterpillar. Contact your Caterpillar Dealer for operator guarding options on your machine.

IV. Machine Protection

Check the job for unusually demanding conditions that could cause premature failure or excessive wear of machine components. Additional protective devices such as heavy-duty radiator guards, crankcase guards, engine enclosures, track roller guards and/or brake shields may be needed. Also, consider the use of anti-vandalism devices, such as cap locks and instrument panel guards. Contact your Caterpillar dealer for machine-protection and vandalism-prevention options for your machine.

V. Fire Prevention

Remember that most fluids on your machine are flammable!

To minimize the risk of fire, Caterpillar recommends following these basic steps:

- Remove trash (leaves, twigs, papers, etc.) that may accumulate in the engine compartment.
- Do not operate a machine if leakage of flammable fluids is noticed. Repair leaks before resuming machine operation. Most fluids used in Caterpillar machines should be considered flammable.
- Keep access doors to major machine compartments in working order to permit the use of fire fighting equipment, should a fire occur.
- Avoid attaching electrical wiring to hoses and tubes that contain flammable or combustible fluids.

- Replace any rubbing, damaged, frayed, kinked or leaking hydraulic hoses or fittings.
- Follow safe fueling practices as described in Caterpillar Operation & Maintenance Manuals, EMI or CIMA Safety Manuals, and local regulations.

As an additional safety measure, keep a 10-pound (4.5 kg) minimum fire extinguisher on the machine in a location as specified in the Operator and Maintenance Manual.

VI. Safety Regulations

Regulations vary from country to country and often within country. Your Caterpillar dealer can assist you in properly equipping your machine to meet applicable requirements. **Note: The general summaries given below are not substitutes for reading and being familiar with the appropriate local laws.**

(a) United States (US)

With a few exceptions, all machine operations in the United States are covered by federal and/or state regulations. If the machine is used in mining activities, the regulations are administered by the Mine Safety and Health Administration (MSHA). Other activities, including construction, are under regulations administered by the Occupational Safety and Health Administration (OSHA). These agencies require employers to provide a safe working environment for employees. Caterpillar has the same objective.

OSHA and MSHA have adopted criteria for ROPS, Falling Object Protective Structures (FOPS), seat belts, warning horns, back-up alarms, operator sound levels, steering systems, and braking systems. Additional operator's compartment protection may be required for machines engaged in logging, demolition and other special applications.

(b) European Union (EU)

The EU Machinery Safety Directive applies to Caterpillar machines and most work tools. It requires that the "CE mark" be applied to the product and that a manufacturer's declaration be provided. The "CE mark" indicates that safety issues have been addressed by applying the appropriate safety standards in the design and manufacture of the machine. The objective of the Safety Directive is to protect operators, spectators and maintenance personnel. Caterpillar fully supports this objective.

VII. Sound Suppression

Different marketing areas have different noise emission requirements. Noise regulations usually specify limits for operators and spectators.

(a) United States

OSHA and MSHA noise-control regulations set permissible noise-exposure limits for machine operators and employees. Operator protection from machine noise can be achieved by use of factory-built cabs as offered in the Caterpillar Price List. These cabs, when properly maintained and operated with the doors and windows closed, reduce the operator sound level for an eight-hour operating period to meet the OSHA and MSHA noise-exposure limits in effect at the date of manufacture. Variables that may be encountered on the job site, such as other nearby noise sources or noise-reflecting surfaces, may reduce the allowable work hours. If this occurs, ear protective devices may be required.

(b) European Union

Operator sound-exposure requirements for machines in Europe are very similar to the OSHA and MSHA regulations mentioned above. In addition to operator sound-exposure requirements, certain types of Caterpillar machines are subject to European Commission regulations for exterior sound levels. Caterpillar ensures its products sold in the EU comply with the applicable noise regulations.

VIII. Replacement Parts for your Caterpillar Machine

WARNING

When replacement parts are required for this product, Caterpillar recommends using Caterpillar replacement parts or parts with equivalent specifications including, but not limited to, physical dimensions, type, strength and material. Failure to heed this warning can lead to premature failures, product damage, personal injury or death.

Nomenclature

THE CATERPILLAR PRODUCT LINE

TRACK-TYPE TRACTORS

Flywheel power 52 to 634 kW (70 to 850 hp)

◀Brazilian Domestic Only

*Waste Handling Arrangements (WHA)

available for sanitary landfill applications

**Also available with hydrostatic power train.



D3C Series III**
D3C XL Series III**
D3C LGP Series III**



D4C Series III**
D4C XL Series III**
D4C LGP Series III**



D5C Series III**
D5C XL Series III**
D5C LGP Series III**



D5M XL
D5M LGP



D5E◀



D6M XL
D6M LGP



D6G



D6R*
D6R XL
D6R XR
D6R LGP



D7G



D7R*
D7R XR
D7R LGP



D8R*
D8R LGP



D9R*



D10R*



D11R

AGRICULTURAL EQUIPMENT

*Variable Horsepower arrangements available
(SR) Super Rural



D4E SR*



D6G SR*



Challenger 35



Challenger 45



Challenger 55



Challenger 65E



Challenger 75E



Challenger 85E*



Challenger 95E



LEXION 460/465



LEXION 480/485

MOTOR GRADERS

Flywheel power 104 to 373 kW (140 to 500 hp)

*All Wheel Drive



120H
120H NA
120H ES



135H
135H NA



12H
12H NA
12H ES



140H
140H NA
140H ES



143H NA*



160H
160H NA
160H ES



163H NA*



14H



16H



24H

HYDRAULIC EXCAVATORS

Operating Weight 6700 to 316 600 kg (14,770 to 698,000 lb)

Track Models



301.5



307B
307B SB



311B



312B
312B L



315B
315B L



318B L
318B LN



320B
320B L
320B N
320B LN
320B S



322B
322B L
322B LN



325B
325B L
325B LN



330B
330B L
330B LN



345B
345B L – FIX
345B L – VG



350
350 L



375
375 L



5130B



5230

Wheel Models

Front Shovels

Operating Weight 83 800 to 318 500 kg (184,600 to 702,000 lb)

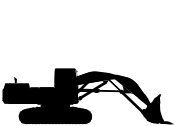

5080



5130B



5230



M312



M315



M318



M320

BACKHOE LOADERS

Digging depth 4420 to 6528 mm (14'6" to 21'5")



416C



426C



428C



436C



438C



446B

WHEEL SKIDDERS

Flywheel power 104 to 145 kW (140 to 195 hp)



515



525



528B



517 Cable



517 Grapple



527 Cable



527 Grapple

TRACK SKIDDERS

Flywheel power 89 to 112 kW (120 to 150 hp)

PIPELAYERS

Lifting capacity 18 145 to 104 330 kg (40,000 to 230,000 lb)



561M



572R



583R



589

WHEEL TRACTOR-SCRAPERS

*Available in auger scraper version

Standard Models

Heaped capacity 15.3 to 33.6 m³ (20 to 44 yd³)



621F*



631E Series II*



651E*

Tandem Powered Scrapers

Heaped capacity 15.3 to 33.6 m³ (20 to 44 yd³)



627F*



637E Series II*



657E*

Elevating Scrapers

Heaped capacity 8.4 to 26 m³ (11 to 34 yd³)



613C Series II



615C Series II



623F



633E Series II

Push-Pull Scrapers

Heaped capacity 15.3 to 33.6 m³ (20 to 44 yd³)



627F



637E Series II



657E

CONSTRUCTION & MINING TRUCKS/TRACTORS

Construction & Mining Trucks

Capacity 36.8 to 218 metric ton — 40.6 to 240 U.S. tons



769D



773D



777D



785C



789C



793C

771D Quarry Truck 775D Quarry Truck

Construction & Mining Tractors

Flywheel power 699 to 962 kW (938 to 1290 hp)



776D



784C

ARTICULATED TRUCKS

Capacity 22.7 to 36.3 metric tons (25 to 40 U.S. tons)



D25D



D30D



D250E Series II



D300E Series II



D350E



D400E

WHEEL TRACTORS

Flywheel power 164 to 597 kW (220 to 800 hp)



814F



824G



834B



844



854G

LANDFILL COMPACTORS

Flywheel power 164 to 353 kW (220 to 473 hp)



816F



826G



836



815F



825G

SOIL COMPACTORS

Flywheel power 164 to 235 kW (220 to 315 hp)

WHEEL LOADERS

Bucket Capacity (Heaped) 1.2 to 30 m³ (1.6 to 40 yd³)

* High lift arrangement available.



902



906



914G



924F



928G



938G*



950G



962G



966F Series II*



970F



980G*



988F Series II*



990 Series II



992G



994*

TRACK LOADERS

Bucket Capacity (Heaped)** 1.0 to 3.6 m³ (1.3 to 4.2 yd³)

*Wide track arrangements available.

**General Purpose Bucket.



933C*



939C



953C*



963B*



973*

INTEGRATED TOOLCARRIERS

Bucket Capacity (Heaped)* 1.3 to 3.1 m³ (1.7 to 4.0 yd³)

*General Purpose Bucket.



IT14G



IT24F



IT28G



IT38G



IT62G

TELESCOPIC HANDLERS



TH62



TH63



TH82



TH83



TH103

PAVING PRODUCTS

Cold Planers

Cutting widths 1905 & 2100 mm (6'3" & 6'11")
Flywheel Power 343 & 466 kW (460 & 625 hp)



PM-465



PM-565B

Reclaimer Mixers/Stabilizer Mixers

Flywheel power 250-321 kW (335-430 hp)
Cutting width 2438 mm (8'0")



RR-250B



SS-250B



RM-350B

Windrow Elevators

Operating weight 5897 kg (13,000 lb)



BG-650

Asphalt Pavers

Paving width 914 to 9754 mm (3 to 32 ft)



AP-200B



AP-800C



AP-1000B



AP-650B



AP-1050B



AP-1055B



BG-210B



BG-230



BG-240B



BG-260C



BG-225C



BG-245C



BG-265B



BG-2455C

Road Wideners

Laydown width to 3048 mm (to 10'0")



BG-730

PAVING PRODUCTS (Continued)

Smooth Drum Vibratory Soil Compactors

Drum width 1270 mm to 2130 mm (4'2" to 7'0")



CS-323C



CS-431C



CS-433C



CS-531C



CS-533C



CS-563C



CS-573C



CS-583C

Padded Drum Vibratory Soil Compactors

Drum width 1270 to 2130 mm (4'2" to 7'0")



CP-323C



CP-433C



CP-533C



CP-563C

Dual Drum Vibratory Asphalt Compactors

Drum width 1000 to 2130 mm (3'3.4" to 7'0")



CB-214C



CB-224C



CB-434C



CB-534C



CB-634C



CB-214C



CB-224C



CB-434B



CB-534C



CB-544

Pneumatic Tire Asphalt Compactors

Wheel loads 1134 to 5000 kg (2500 to 11,020 lb)



PS-150B



PS-200B



PS-360B



PF-300B PS-300B



PS-500

Combination Vibratory Compactor

Drum Width 1700 mm (5'7")



CB-535B



CB-545

UNDERGROUND MINING (ELPHINSTONE)

Load-Haul-Dump

Bucket sizes 2.4-8.8 m³ (3-12 yd³)



R1300



R1600



R1700 Series II



R2900

Articulated Trucks



AD40 Series II



AE40 Series II

40 t (44 T) capacity

Rigid Frame Trucks



69D Dump

38 t (42 T)



69D Ejector

36.2 t (40 T)



73D

52.2 t (58 T)

ENGINES

Application configurations include: On and off highway trucks, stationary and mobile industrial, marine, electrical power generation and petroleum. Spark-ignited (SI) available as noted. Generator set kW shown is 60 Hertz.

1.1 L Family

- 104 to 224 kW (140 to 300 hp) Diesel Engine



3200 Family

- 93 to 317 kW (125 to 425 hp) Diesel Engine
- 160 to 200 kW Diesel Generator Sets



3500 Family

- 448 to 1641 kW (600 to 2200 hp) Diesel Engine
- 715 to 2000 kW Diesel Generator Sets
- 392 to 858 kW (525 to 1150 hp) SI Engine
- 360 to 800 kW SI Generator Sets



3300 Family

- 64 to 265 kW (85 to 355 hp) Diesel Engine
- 65 to 250 kW Diesel Generator Sets
- 62 to 164 kW (83 to 220 hp) SI Engine
- 85 to 150 kW SI Generator Sets



3600 Family

- 1560 to 5420 kW (2090 to 7270 hp) Diesel Engine
- 1375 to 4910 kW Diesel Generator Sets



3400 Family

- 186 to 746 kW (250 to 1000 hp) Diesel Engine
- 210 to 800 kW Diesel Generator Sets
- 336 kW (450 hp) SI Engine
- 270 to 470 kW SI Generator Sets



TRACK-TYPE TRACTORS

WASTE HANDLING TRACK-TYPE TRACTORS

Hydraulic Controls

Bulldozers

Rippers & Winches

Towed Scrapers

CONTENTS

TRACK-TYPE TRACTORS

Features	1-2
Specifications	1-3
Power shift drawbar pull vs. ground speed curves	1-13
Power shift travel speeds	1-20
Direct drive travel speeds and drawbar pull	1-21
Ground pressures	1-23
Extreme slope operation	1-24

WASTE HANDLING TRACK-TYPE TRACTORS

Features	1-25
Specifications	1-26
Bulldozer specifications	1-28

HYDRAULIC CONTROLS

Features	1-31
Specifications	1-32

BULLDOZERS

Features	1-35
Summary of blade options	1-36
Blade selection	1-37
General dimensions (Tractor and Blade)	1-40
Blade specifications	1-41
Estimating bulldozer production off-the-job ..	1-49
Job condition correction factors	1-53
Measuring bulldozer production on-the-job ..	1-54
Special attachments	1-54

RIPPERS

Features	1-57
Ripper Dimension Drawings	
Adjustable Parallelogram Ripper	1-58
Radial Ripper	1-60
Fixed Parallelogram Ripper	1-60
Specifications	
Track-Type Tractors	1-61
Tip selection	1-67
Estimating ripping production	1-68
Seismic wave velocity charts	1-69
Estimating ripper production graphs	1-75

WINCHES

Features	1-77
Physical specifications	1-78
Operating specifications	1-81

TOWED SCRAPERS

Estimated production	1-83
----------------------------	------

TRACK-TYPE TRACTORS

Features:

- **Cat Diesel Engines** provide power, high torque rise, reliability and performance you can depend on.
- **Hydraulic Electronic Unit Injection** on D9R and D10R increases fuel efficiency, reduces smoke, improves cold starting and enhances diagnostic capabilities.
- **Electronic Unit Injection (EUI)** on D11R. The Electronic Control Module (ECM) performs much like a mechanical governor, but has no moving parts. The ECM signals the injectors regulating the fuel supply thus controlling engine speed and power. EUI provides: Reduced exhaust smoke, automatic altitude compensation and cold start protection.
- **Oil cooled steering clutches and brakes** standard on all models except the D8R. Improves reliability and component life. Oil disc brakes on D5M XL and up. Oil cooled contracting band type used on D3C Series III, D4C Series III and D5C Series III power shift models.
- **Finger Tip Controls (FTC)** of transmission, steering clutches and brakes available on D5M, D6M, D6R, D7R, D10R and D11R.
- **Differential steering** allows infinitely variable turning radius. Standard on the D8R and optional on the D6R, D7R and D9R, allows the tractor to make a “power turn” keeping both tracks working for more traction and higher performance.
- **Hydrostatic Power Train System** available on D3C Series III thru D5C Series III allows full power turns, stepless speed range, smooth modulation, dynamic hydrostatic braking, superior maneuverability and excellent controllability.
- **Combined hand lever steering** located left of operator provides easier operation on D5M XL, D6M XL and D9R. Combined pedal steering standard on the D3C Series III, D4C Series III and D5C Series III. Optional combined hand lever clutch and brake for D3C Series III, D4C Series III and D5C Series III.
- **Standard Tractors** designed for heavy dozing and general grading.
- **XL Tractors** offer higher horsepower and longer roller frames for increased finish grading capability, flotation and productivity. Wider gauge available on D6R XL through Caterpillar Custom Products.
- **Sealed and Lubricated Track** reduces pin and bushing wear for lower undercarriage repair costs. Heavy duty track chain available on D5M, D6M, D6R and D7R improves wear life and reduces pin/bore stretching and cracking.
- **Elevated sprockets** on D5M XL and up eliminate final drive stress induced by roller frame movement and ground impact loads. Final drives pull chain only. Seals moved up out of dirt, sand and water for longer life. Blade visibility improved because operator sits higher.
- **Resilient mounted bogie undercarriage** on D8R, D9R, D10R and D11R reduces shock transmitted to tractor.
- **Solid mounted undercarriage** standard on D3C Series III through D7R and optional on the D8R provides stable platform for low impact, high abrasion applications like finish grading and stockpiling.
- **Accessible modular design** on D5M XL and up greatly reduces drive train removal and installation time resulting in reduced repair costs.
- **Tag link** on D7R and up; L-shaped push arms on D6M through D6R. Both designs allow closer mounting of dozer blades. This reduces total tractor length, improves maneuverability, balance, blade penetration and pryout.



MODEL	D3C Series III		D3C Series III Hystat		D3C XL Series III		D3C XL Series III Hystat	
	52 kW	70 hp	52 kW	70 hp	52 kW	70 hp	52 kW	70 hp
Flywheel Power	52 kW	70 hp	52 kW	70 hp	52 kW	70 hp	52 kW	70 hp
Operating Weight* (Power Shift)	7039 kg	15,518 lb	7112 kg	15,680 lb	7231 kg	15,941 lb	7304 kg	16,103 lb
Engine Model	3046		3046		3046		3046	
Rated Engine RPM	2400		2400		2400		2400	
No. of Cylinders	6		6		6		6	
Bore	94 mm	3.7"	94 mm	3.7"	94 mm	3.7"	94 mm	3.7"
Stroke	120 mm	4.7"	120 mm	4.7"	120 mm	4.7"	120 mm	4.7"
Displacement	5.0 L	305 in ³	5.0 L	305 in ³	5.0 L	305 in ³	5.0 L	305 in ³
Track Rollers (Each Side)	5		5		6		6	
Width of Standard Track Shoe	406 mm	16"	406 mm	16"	406 mm	16"	406 mm	16"
Length of Track on Ground	1899 mm	6'2.8"	1899 mm	6'2.8"	2055 mm	6'8.9"	2055 mm	6'8.9"
Ground Contact Area (W/Std. Shoe)	1.55 m ²	2390 in ²	1.55 m ²	2390 in ²	1.67 m ²	2586 in ²	1.67 m ²	2586 in ²
Track Gauge	1422 mm	4'8"	1448 mm	4'9"	1448 mm	4'9"	1448 mm	4'9"
GENERAL DIMENSIONS:								
Height (Stripped Top)**	1.70 m	5'7"	1.70 m	5'7"	1.70 m	5'7"	1.70 m	5'7"
Height (To Top of ROPS)	2.66 m	8'9"	2.73 m	8'11"	2.66 m	8'9"	2.73 m	8'11"
Overall Length (With P Blade)	3.77 m	12'5"	3.98 m	13'1"	4.02 m	13'2"	3.98 m	13'1"
(Without Blade)	2.93 m	9'7"	2.96 m	9'8"	2.98 m	9'9"	2.96 m	9'8"
Width (Over Trunnion)	—		—		—		—	
Width (W/O Trunnion — Std. Shoe)	1.83 m	6'0"	1.85 m	6'1"	1.83 m	6'0"	1.85 m	6'1"
Ground Clearance	322 mm	12.7"	374 mm	14.7"	374 mm	14.7"	374 mm	14.7"
Blade Types and Widths:								
Straight	—		—		—		—	
Angle	—		—		—		—	
Angle Straight	—		—		—		—	
Universal	—		—		—		—	
Semi-U	—		—		—		—	
"P" Straight	2.55 m	8'4"	2.55 m	8'4"	2.55 m	8'4"	2.55 m	8'4"
Angled	2.31 m	7'6"	2.31 m	7'6"	2.31 m	7'6"	2.31 m	7'6"
Fuel Tank Refill Capacity	122 L	32.2 U.S. gal	165 L	43.6 U.S. gal	165 L	43.6 U.S. gal	165 L	43.6 U.S. gal

*Operating Weight includes ROPS canopy, operator, lubricants, coolant, full fuel tank, hydraulic controls and fluids, back-up alarm, seat belts, lights, rigid drawbar, front pull device and standard service crankcase guard.

**Height (stripped top) — without ROPS, exhaust, seat back or other easily removed encumbrances.



MODEL	D3C LGP Series III		D3C LGP Series III Hystat		D4C Series III		D4C Series III Hystat	
	52 kW	70 hp	52 kW	70 hp	60 kW	80 hp	60 kW	80 hp
Flywheel Power	52 kW	70 hp	52 kW	70 hp	60 kW	80 hp	60 kW	80 hp
Operating Weight* (Power Shift)	7640 kg	16,842 lb	7713 kg	17,004 lb	7266 kg	16,019 lb	7326 kg	16,150 lb
Engine Model	3046		3046		3046		3046	
Rated Engine RPM	2400		2400		2400		2400	
No. of Cylinders	6		6		6		6	
Bore	94 mm	3.7"	94 mm	3.7"	94 mm	3.7"	94 mm	3.7"
Stroke	120 mm	4.7"	120 mm	4.7"	120 mm	4.7"	120 mm	4.7"
Displacement	5.0 L	305 in ³	5.0 L	305 in ³	5.0 L	305 in ³	5.0 L	305 in ³
Track Rollers (Each Side)	6		6		6		6	
Width of Standard Track Shoe	635 mm	2'1"	635 mm	2'1"	406 mm	16"	406 mm	16"
Length of Track on Ground	2055 mm	6'8.9"	2055 mm	6'8.9"	2055 mm	6'8.9"	2055 mm	6'8.9"
Ground Contact Area (W/Std. Shoe)	2.61 m ²	4045 in ²	2.61 m ²	4045 in ²	1.67 m ²	2586 in ²	1.67 m ²	2586 in ²
Track Gauge	1676 mm	5'6"	1676 mm	5'6"	1499 mm	4'11"	1499 mm	4'11"
GENERAL DIMENSIONS:								
Height (Stripped Top)**	1.70 m	5'7"	1.70 m	5'7"	1.75 m	5'9"	1.75 m	5'9"
Height (To Top of ROPS)	2.66 m	8'9"	2.73 m	8'11"	2.73 m	8'11"	2.73 m	8'11"
Overall Length (With P Blade)	3.99 m	13'1"	3.95 m	13'0"	3.99 m	13'1"	3.99 m	13'1"
(Without Blade)	2.98 m	9'9"	2.96 m	9'8"	2.96 m	9'8"	2.96 m	9'8"
Width (Over Trunnion)	—		—		—		—	
Width (W/O Trunnion — Std. Shoe)	2.29 m	7'6"	2.31 m	7'7"	1.91 m	6'3"	1.91 m	6'3"
Ground Clearance	374 mm	14.7"	374 mm	14.7"	374 mm	14.7"	374 mm	14.7"
Blade Types and Widths:								
Straight	2.80 m	9'2"	—		—		—	
Angle	—		—		—		—	
Angle Straight	—		—		—		—	
Universal	—		—		—		—	
Semi-U	—		—		—		—	
"P" Straight	3.19 m	10'6"	3.19 m	10'6"	2.74 m	9'0"	2.74 m	9'0"
Angled	2.90 m	9'5"	2.90 m	9'5"	2.49 m	8'2"	2.49 m	8'2"
Fuel Tank Refill Capacity	165 L	43.6 U.S. gal	165 L	43.6 U.S. gal	157 L	41.4 U.S. gal	157 L	41.4 U.S. gal

*Operating Weight includes ROPS canopy, operator, lubricants, coolant, full fuel tank, hydraulic controls and fluids, back-up alarm, seat belts, lights, rigid drawbar, front pull device and standard service crankcase guard.

**Height (stripped top) — without ROPS, exhaust, seat back or other easily removed encumbrances.



MODEL	D4C XL Series III		D4C XL Series III Hystat		D4C LGP Series III		D4C LGP Series III Hystat	
	60 kW	80 hp	60 kW	80 hp	60 kW	80 hp	60 kW	80 hp
Flywheel Power	60 kW	80 hp	60 kW	80 hp	60 kW	80 hp	60 kW	80 hp
Operating Weight* (Power Shift)	7458 kg	16,442 lb	7518 kg	16,573 lb	7726 kg	17,032 lb	7785 kg	17,163 lb
Engine Model	3046		3046		3046		3046	
Rated Engine RPM	2400		2400		2400		2400	
No. of Cylinders	6		6		6		6	
Bore	94 mm	3.7"	94 mm	3.7"	94 mm	3.7"	94 mm	3.7"
Stroke	120 mm	4.7"	120 mm	4.7"	120 mm	4.7"	120 mm	4.7"
Displacement	5.0 L	305 in³	5.0 L	305 in³	5.0 L	305 in³	5.0 L	305 in³
Track Rollers (Each Side)	7		7		6		6	
Width of Standard Track Shoe	457 mm	18"	457 mm	18"	635 mm	2'1"	635 mm	2'1"
Length of Track on Ground	2210 mm	7'3"	2210 mm	7'3"	2055 mm	6'8.9"	2055 mm	6'8.9"
Ground Contact Area (W/Std. Shoe)	2.02 m ²	3131 in²	2.02 m ²	3131 in²	2.61 m ²	4045 in²	2.61 m ²	4045 in²
Track Gauge	1499 mm	4'11"	1499 mm	4'11"	1676 mm	5'6"	1676 mm	5'6"
GENERAL DIMENSIONS:								
Height (Stripped Top)**	1.75 m	5'9"	1.75 m	5'9"	1.75 m	5'9"	1.75 m	5'9"
Height (To Top of ROPS)	2.73 m	8'11"	2.73 m	8'11"	2.73 m	9'0"	2.73 m	8'11"
Overall Length (With P Blade)	3.99 m	13'1"	3.99 m	13'1"	3.99 m	13'1"	3.99 m	13'1"
(Without Blade)	3.04 m	10'0"	3.04 m	10'0"	2.96 m	9'8"	2.96 m	9'8"
Width (Over Trunnion)	—		—		—		—	
Width (W/O Trunnion — Std. Shoe)	1.96 m	6'5"	1.96 m	6'5"	2.31 m	7'6"	2.31 mm	7'6"
Ground Clearance	374 mm	14.7"	374 mm	14.7"	374 mm	14.7"	374 mm	14.7"
Blade Types and Widths:								
Straight	—		—		—		—	
Angle	—		—		—		—	
Angle Straight	—		—		—		—	
Universal	—		—		—		—	
Semi-U	—		—		—		—	
"P" Straight	2.74 m	9'0"	2.74 m	9'0"	3.34 m	10'11"	3.34 m	10'11"
Angled	2.49 m	8'2"	2.49 m	8'2"	3.03 m	9'11"	3.03 m	9'11"
Fuel Tank Refill Capacity	157 L	41.4 U.S. gal	157 L	41.4 U.S. gal	157 L	41.4 U.S. gal	157 L	41.4 U.S. gal

*Operating Weight includes ROPS canopy, operator, lubricants, coolant, full fuel tank, hydraulic controls and fluids, back-up alarm, seat belts, lights, rigid drawbar, front pull device and standard service crankcase guard.

**Height (stripped top) — without ROPS, exhaust, seat back or other easily removed encumbrances.



MODEL	D5C Series III		D5C Series III Hystat		D5C XL Series III		D5C XL Series III Hystat	
Flywheel Power: Power Shift	67.1 kW	90 hp	67.1 kW	90 hp	67.1 kW	90 hp	67.1 kW	90 hp
Operating Weight* (Power Shift)	8428 kg	18,580 lb	8487 kg	18,711 lb	8762 kg	19,316 lb	8821 kg	19,447 lb
Engine Model	3046		3046		3046		3046	
Rated Engine RPM	2400		2400		2400		2400	
No. of Cylinders	6		6		6		6	
Bore	94 mm	3.7"	94 mm	3.7"	94 mm	3.7"	94 mm	3.7"
Stroke	120 mm	4.7"	120 mm	4.7"	120 mm	4.7"	120 mm	4.7"
Displacement	5.0 L	305 in³	5.0 L	305 in³	5.0 L	305 in³	5.0 L	305 in³
Track Rollers (Each Side)	6		6		7		7	
Width of Standard Track Shoe	457 mm	18"	457 mm	18"	508 mm	1'8"	508 mm	1'8"
Length of Track on Ground	2145 mm	7'0"	2145 mm	7'0.4"	2320 mm	7'7"	2316 mm	7'7.2"
Ground Contact Area (W/Std. Shoe)	1.96 m ²	3039 in²	1.96 m ²	3039 in²	2.35 m ²	3547 in²	2.35 m ²	3547 in²
Track Gauge	1549 mm	5'1"	1549 mm	5'1"	1549 mm	5'1"	1549 mm	5'1"
GENERAL DIMENSIONS:								
Height (Stripped Top)**	1.75 m	5'9"	1.75 m	5'9"	1.75 m	5'9"	1.75 m	5'9"
Height (To Top of ROPS)	2.74 m	9'0"	2.74 m	9'0"	2.74 m	9'0"	2.74 m	9'0"
Overall Length (With P Blade)***	4.07 m	13'4"	4.07 m	13'4"	4.32 m	14'2"	4.32 m	14'2"
(Without Blade)	3.00 m	9'10"	3.00 m	9'10"	3.18 m	10'5"	3.18 m	10'5"
Width (W/O Trunnion — Std. Shoe)	2.00 m	6'7"	2.00 m	6'7"	2.06 m	6'9"	2.06 m	6'9"
Ground Clearance	384 mm	15.1"	384 mm	15.1"	384 mm	15.1"	384 mm	15.1"
Blade Types and Widths:								
Straight	—		—		—		—	
Angle	—		—		—		—	
"P" Straight	2.75 m	9'0"	2.75 m	9'0"	2.69 m	8'10"	2.69 m	8'10"
Angled	2.50 m	8'2"	2.50 m	8'2"	2.50 m	8'2"	2.50 m	8'2"
Fuel Tank Refill Capacity	157 L	41.4 U.S. gal	157 L	41.4 U.S. gal	157 L	41.4 U.S. gal	157 L	41.4 U.S. gal

*Operating Weight includes ROPS canopy, operator, lubricants, coolant, full fuel tank, hydraulic controls and fluids, P blade, rigid drawbar, front towing device, standard service crankcase guards, engine enclosures and suspension seat.

**Height (stripped top) — without ROPS canopy, exhaust, pre-cleaner, seat back or other easily removed encumbrances.

***D5M XL, D5M LGP with UPAT blade.



MODEL	D5C LGP Series III		D5C LGP Series III Hystat		D5M XL		D5M LGP		
	Flywheel Power: Power Shift Direct Drive	67.1 kW	90 hp	67.1 kW	90 hp	82 kW	110 hp	82 kW	110 hp
Operating Weight:* Power Shift Direct Drive	8913 kg	19,649 lb	8972 kg	19,780 lb	11 700 kg	25,800 lb	12 600 kg	27,800 lb	
Engine Model		3046		3046		3116T		3116T	
Rated Engine RPM		2400		2400		2100		2100	
No. of Cylinders		6		6		6		6	
Bore	94 mm	3.7"	94 mm	3.7"	105 mm	4.1"	105 mm	4.1"	
Stroke	120 mm	4.7"	120 mm	4.7"	127 mm	5"	127 mm	5"	
Displacement	5.0 L	305 in³	5.0 L	305 in³	6.6 L	403 in³	6.6 L	403 in³	
Track Rollers (Each Side)		6		6		7		7	
Width of Standard Track Shoe	660 mm	2'2"	660 mm	2'2"	560 mm	1'10"	760 mm	2'6"	
Length of Track on Ground	2145 mm	7'0.4"	2145 mm	7'0.4"	2390 mm	7'10"	2600 mm	8'7"	
Ground Contact Area (W/Std. Shoe)	2.83 m ²	4389 in²	2.83 m ²	4389 in²	2.67 m ²	4144 in²	3.96 m ²	6133 in²	
Track Gauge	1727 mm	5'8"	1727 mm	5'8"	1770 mm	5'10"	2000 mm	6'7"	
GENERAL DIMENSIONS:									
Height (Stripped Top)**	1.75 m	5'9"	1.75 m	5'9"	2.22 m	7'3"	2.26 m	7'5"	
Height (To Top of ROPS Canopy)	2.74 m	9'0"	2.74 m	9'0"	3.00 m	9'10"	3.04 m	10'0"	
Height (To Top of ROPS Cab)	—	—	—	—	3.00 m	9'10"	3.05 m	10'0"	
Overall Length (With P Blade)***	4.07 m	13'4"	4.07 m	13'4"	4.56 m	14'11"	5.13 m	16'10"	
(Without Blade)	3.00 m	9'10"	3.00 m	9'10"	3.54 m	11'8"	3.73 m	12'3"	
Width (W/O Trunnion — Std. Shoe)	2.38 m	7'10"	2.39 m	7'10"	2.33 m	7'8"	2.76 m	9'1"	
Ground Clearance	384 mm	15.1"	384 mm	15.1"	385 mm	15.2"	437 mm	17.2"	
Blade Types and Widths:									
Straight	—	—	—	—	—	—	—	—	
Angle	—	—	—	—	—	—	—	—	
"P" Straight	3.30 m	10'10"	3.30 m	10'10"	—	—	—	—	
Angled	3.00 m	9'10"	3.00 m	9'10"	—	—	—	—	
UPAT	—	—	—	—	3.08 m	10'1"	3.36 m	11'0"	
Fuel Tank Refill Capacity	157 L	41.4 U.S. gal	157 L	41.4 U.S. gal	218 L	57.5 U.S. gal	218 L	57.5 U.S. gal	

*Operating Weight includes ROPS canopy, operator, lubricants, coolant, full fuel tank, hydraulic controls and fluids, P blade, rigid drawbar, front towing device, standard service crankcase guards, engine enclosures and suspension seat.

**Height (stripped top) — without ROPS canopy, exhaust, pre-cleaner, seat back or other easily removed encumbrances.

***D5M XL, D5M LGP with UPAT blade.



MODEL	D5E▶		D6M XL		D6M LGP		D6G	
Flywheel Power: Power Shift	78 kW	105 hp	104 kW	140 hp	104 kW	140 hp	116 kW	155 hp
Operating Weight:* Power Shift	—		15 050 kg	33,200 lb	16 500 kg	36,400 lb	15 432 kg	34,028 lb
Direct Drive	11 702 kg	25,800 lb	—		—		—	
Engine Model	3306		3116T		3116T		3306T	
Rated Engine RPM: Power Shift	—		2200		2200		1900	
Direct Drive	1750		—		—		—	
No. of Cylinders	6		6		6		6	
Bore	121 mm	4.75"	105 mm	4.1"	105 mm	4.1"	121 mm	4.75"
Stroke	152 mm	6"	127 mm	5"	127 mm	5"	152 mm	6"
Displacement	10.5 L	638 in³	6.6 L	403 in³	6.6 L	403 in³	10.5 L	638 in³
Track Rollers (Each Side)	6		7		8		7	
Width of Standard Track Shoe	457 mm	18"	600 mm	2'0"	860 mm	2'10"	508 mm	1'8"
Length of Track on Ground	2.21 m	7'3"	2.55 m	8'4"	3.08 m	10'1"	2.67 m	8'9"
Ground Contact Area (W/Std. Shoe)	2.05 m ²	3154 in²	3.06 m ²	4743 in²	5.30 m ²	8217 in²	2.72 m ²	4216 in²
Track Gauge	1.52 m	5'0"	1.89 m	6'2"	2.16 m	7'1"	1.88 m	6'2"
GENERAL DIMENSIONS:								
Height (Stripped Top)**	1.90 m	6'6"	2.30 m	7'6.5"	2.41 m	7'11"	2.10 m	6'11"
Height (To Top of ROPS Canopy)	—		3.02 m	9'11"	3.14 m	10'4"	—	
Height (To Top of ROPS)	2.95 m	9'8"	—		—		3.20 m	10'5"
Height (To Top of Cab ROPS)	—		3.08 m	10'1"	3.19 m	10'6"	—	
Overall Length (With P Blade)***	—		4.80 m	15'9"	5.37 m	17'8"	—	
(Without Blade)	—		3.74 m	12'3"	4.15 m	13'7"	—	
Overall Length (With S Blade)	—		4.92 m	16'2"	—		5.00 m	16'4"
(Without Blade)	3.88 m	12'8"	3.74 m	12'3"	4.15 m	13'7"	3.94 m	12'9"
Width (Over Trunnion)	—		3.19 m	10'6"	—		—	
Width (W/O Trunnion — Std. Shoe)	2.03 m	6'8"	2.49 m	8'2"	3.02 m	9'11"	2.39 m	7'10"
Ground Clearance	277 mm	10.9"	424 mm	16.7"	538 mm	1'9.2"	310 mm	12.2"
Blade Types and Widths:								
Straight	—		—		—		3.20 m	10'6"
Angle	3.34 m	10'11"	—		—		3.90 m	12'9"
Semi-U	—		3.17 m	10'6"	—		3.20 m	10'6"
"P" Straight	—		—		—		—	
Power Angle & Tilt	—		3.27 m†	10'9"	4.08 m†	13'5"	—	
Fuel Tank Refill Capacity	295 L	78 U.S. gal	311 L	82.2 U.S. gal	311 L	82.2 U.S. gal	300 L	80 U.S. gal

* Operating Weight includes ROPS canopy, operator, lubricants, coolant, full fuel tank, hydraulic controls and fluids, straight dozer with tilt (UPAT on D5M LGP and D6M) rigid drawbar, front towing device, engine enclosures and suspension seat.

** Height (stripped top) — without ROPS canopy, exhaust, pre-cleaner, seat back or other easily removed encumbrances.

*** UPAT blade on D5M LGP and D6M.

† SU blade on D6M.

▶ Brazilian Domestic only.



MODEL	D6R		D6R XL		D6R XL (IG)▶		D6R XR	
Flywheel Power	123 kW	165 hp	130 kW	175 hp	138 kW	185 hp	130 kW	175 hp
Operating Weight:*								
Power Shift	18 000 kg	39,700 lb	19 000 kg	41,900 lb	19 780 kg	43,600 lb	18 780 kg	41,400 lb
Direct Drive	18 053 kg**	39,800 lb	—	—	—	—	—	—
Power Shift Differential Steer	18 200 kg	40,000 lb	19 200 kg	42,300 lb	19 960 kg	44,000 lb	18 910 kg	41,700 lb
Engine Model	3306T		3306T		3306T		3306T	
Rated Engine RPM	1900		1900		1900		1900	
No. of Cylinders	6		6		6		6	
Bore	121 mm	4.75"	121 mm	4.75"	121 mm	4.75"	121 mm	4.75"
Stroke	152 mm	6"	152 mm	6"	152 mm	6"	152 mm	6"
Displacement	10.5 L	638 in³	10.5 L	638 in³	10.5 L	638 in³	10.5 L	638 in³
Track Rollers (Each Side)	6		7		7		7	
Width of Standard Track Shoe	560 mm	1'10"	560 mm	1'10"	762 mm	2'6"	560 mm	1'10"
Length of Track on Ground	2.61 m	8'7"	2.82 m	9'3"	2.82 m	9'3"	2.75 m	9'0"
Ground Contact Area (W/Std. Shoe)	2.92 m ²	4523 in²	3.16 m ²	4888 in²	4.3 m ²	6661 in²	3.08 m ²	4771 in²
Track Gauge	1.88 m	6'2"	1.88 m	6'2"	2.03 m	6'8"	1.88 m	6'2"
GENERAL DIMENSIONS:								
Height (Stripped Top)***	2.38 m	7'5"	2.38 m	7'5"	2.38 m	7'5"	2.38 m	7'5"
Height (To Top of ROPS)	3.19 m	10'5"	3.19 m	10'5"	3.19 m	10'5"	3.19 m	10'5"
Height (To Top of Cab ROPS)	3.19 m	10'5"	3.19 m	10'5"	3.19 m	10'5"	3.19 m	10'5"
Height (To Top of ROPS Canopy)	—	—	—	—	—	—	—	—
Overall Length (With S Blade)	5.11 m	16'9"	—	—	—	—	5.26 m	17'3"
(Without Blade)	4.08 m	13'4"	4.08 m	13'4"	—	—	4.22 m	13'10"
Width (Over Trunnion)	2.64 m	8'8"	2.64 m	8'8"	2.95 m	9'8"	2.64 m	8'8"
Width (W/O Trunnion — Std. Shoe)	2.44 m	8'0"	2.44 m	8'0"	2.74 m	9'0"	2.44 m	8'0"
Ground Clearance	383 mm	14.8"	383 mm	14.8"	383 mm	14.8"	383 mm	14.8"
Blade Types and Widths:								
Straight	3.35 m	11'0"	—	—	—	—	3.36 m	11'0"
Angle	—	—	—	—	—	—	—	—
Angle Straight	4.16 m	13'7.8"	4.16 m	13'8"	—	—	4.16 m	13'8"
Full Angle	3.78 m	12'4.7"	3.78 m	12'5"	—	—	3.78 m	12'5"
Universal	—	—	—	—	—	—	—	—
Semi-U	3.26 m	10'8"	3.26 m	10'8"	3.56 m	11'8"	3.26 m	10'8"
Fuel Tank Refill Capacity	383 L	101 U.S. gal	383 L	101 U.S. gal	383 L	101 U.S. gal	383 L	101 U.S. gal

*Operating Weight includes ROPS canopy, operator, lubricants, coolant, full fuel tank, hydraulic controls and fluid, straight dozer with tilt, horn, back-up alarm, retrieval hitch and front pull hook.

**Japan only.

***Height (stripped top) — without ROPS canopy, exhaust, seat back or other easily removed encumbrances.

▶Intermediate Gauge offered as custom product.



MODEL	D6R LGP		D7G		D7R		D7R XR	
Flywheel Power	138 kW	185 hp	149 kW	200 hp	171 kW	230 hp	171 kW	230 hp
Operating Weight:*								
Power Shift	20 500 kg	45,200 lb	20 094 kg	44,300 lb	24 778 kg	54,600 lb	25 193 kg	55,600 lb
Direct Drive	—		20 502 kg	45,200 lb	—		—	
Power Shift Differential Steer	20 680 kg	45,600 lb	—		25 077 kg	55,300 lb	25 492 kg	56,200 lb
Engine Model	3306T		3306T		3306T		3306T	
Rated Engine RPM	1900		2000		2100		2100	
No. of Cylinders	6		6		6		6	
Bore	121 mm	4.75"	121 mm	4.75"	121 mm	4.75"	121 mm	4.75"
Stroke	152 mm	6"	152 mm	6"	152 mm	6"	152 mm	6"
Displacement	10.5 L	638 in³	10.5 L	638 in³	10.5 L	638 in³	10.5 L	638 in³
Track Rollers (Each Side)	8		6		7		8	
Width of Standard Track Shoe	915 mm	3'0"	508 mm	1'8"	560 mm	1'10"	610 mm	2'0"
Length of Track on Ground	3.25 m	10'8"	2.72 m	8'11"	2.89 m	9'6"	3.05 m	10'0"
Ground Contact Area (W/Std. Shoe)	5.93 m ²	9254 in²	2.76 m ²	4280 in²	3.24 m ²	5016 in²	3.72 m ²	5760 in²
Track Gauge	2.23 m	7'3"	1.98 m	6'6"	1.98 m	6'6"	1.98 m	6'6"
GENERAL DIMENSIONS:								
Height (Stripped Top)**	2.43 m	7'7"	2.27 m	7'5"	2.56 m	8'5"	2.56 m	8'5"
Height (To Top of ROPS)	3.24 m	10'5"	3.20 m	10'6"	3.35 m	10'11"	3.35 m	10'11"
Height (To Top of Cab ROPS)	3.24 m	10'5"	—		3.43 m	11'2"	3.43 m	11'2"
Height (To Top of ROPS Canopy)	3.24 m	10'5"	—		—		—	
Overall Length (With S Blade)	—		5.28 m	17'4"	5.69 m	18'8"	5.81 mm	19'1"
(Without Blade)	—		4.19 m	13'9"	4.67 m	15'4"	4.67 m	15'4"
Width (Over Trunnion)	3.43 m	11'3"	—		2.87 m	9'5"	2.87 m	9'5"
Width (W/O Trunnion — Std. Shoe)	3.14 m	10'3.6"	2.55 m	8'5"	2.54 m	8'4"	2.59 m	8'6"
Ground Clearance	433 mm	17"	347 mm	13.7"	416 mm	16.4"	416 mm	16.4"
Blade Types and Widths:								
Straight	3.99 m	13'1"	3.66 m	12'0"	3.52 m	11'7"	3.32 m	11'7"
Angle	—		4.27 m	14'0"	4.50 m	14'9"	4.50 m	14'9"
Angle Straight	—		—		—		—	
Full Angle	—		—		—		—	
Universal	—		—		3.98 m	13'1"	3.98 m	13'1"
Semi-U	—		—		3.69 m	12'2"	3.69 m	12'2"
Fuel Tank Refill Capacity	383 L	101 U.S. gal	435 L	115 U.S. gal	479 L	127 U.S. gal	479 L	127 U.S. gal

*Operating Weight includes ROPS canopy, operator, lubricants, coolant, full fuel tank, hydraulic controls and fluid, straight dozer with tilt, horn, back-up alarm, retrieval hitch and front pull hook.

— D7G includes end track guiding guards.

**Height (stripped top) — without ROPS canopy, exhaust, seat back or other easily removed encumbrances.



MODEL	D7R LGP		D8R		D8R LGP		D9R	
Flywheel Power	179 kW	240 hp	228 kW	305 hp	228 kW	305 hp	302 kW	405 hp
Operating Weight:*								
Power Shift	27 065 kg	59,700 lb	—	—	—	—	47 910 kg	105,630 lb
Power Shift Differential Steer	27 364 kg	60,300 lb	37 580 kg	82,850 lb	33 730 kg	74,360 lb	48 310 kg	106,500 lb
Engine Model	3306T		3406CTA		3406CTA		3408ETA	
Rated Engine RPM	2100		2100		2100		1900	
No. of Cylinders	6		6		6		8	
Bore	121 mm	4.75"	137 mm	5.4"	137 mm	5.4"	137 mm	5.4"
Stroke	152 mm	6"	165 mm	6.5"	165 mm	6.5"	152 mm	6"
Displacement	10.5 L	638 in ³	14.6 L	893 in ³	14.6 L	893 in ³	18 L	1099 in ³
Track Rollers (Each Side)	7		8		8		8	
Width of Standard Track Shoe	914 mm	3'0"	560 mm	1'10"	965 mm	3'2"	610 mm	2'0"
Length of Track on Ground	3.16 m	10'5"	3.21 m	10'6"	3.20 m	10'6"	3.47 m	11'5"
Ground Contact Area (W/Std. Shoe)	5.78 m ²	8960 in ²	3.57 m ²	5544 in ²	6.2 m ²	9576 in ²	4.24 m ²	6569 in ²
Track Gauge	2.24 m	7'4"	2.08 m	6'10"	2.34 m	7'8"	2.25 m	7'5"
GENERAL DIMENSIONS:								
Height (Stripped Top)**	2.74 m	9'0"	2.67 m	8'9"	2.67 m	8'9"	3.00 m	9'10"
Height (To Top of ROPS)	3.43 m	11'3"	3.51 m	11'6"	3.51 m	11'6"	3.99 m	13'1"
Height (To Top of ROPS Canopy)	3.52 m	11'6"	3.51 m	11'6"	3.51 m	11'6"	3.99 m	13'1"
Height (To Top of Cab ROPS)	3.58 m	11'9"	3.45 m	11'3"	3.45 m	11'3"	—	—
Overall Length (With SU Blade)***	—	—	6.39 m	21'0"	6.39 m	21'0"	6.84 m	22'5"
(Without Blade)	—	—	4.93 m	16'2"	4.93 m	16'2"	5.18 m	17'0"
Overall Length (With S Blade)	5.78 m	19'0"	—	—	—	—	—	—
(Without Blade)	4.67 m	15'4"	—	—	—	—	—	—
Width (Over Trunnions)	3.37 m	11'1"	3.05 m	10'0"	3.55 m	11'7"	3.30 m	10'10"
Width (W/O Trunnions — Std. Shoe)	3.15 m	10'4"	2.7 m	8'8"	—	—	2.93 m	9'8"
Width (With Standard Shoe)	—	—	—	—	3.37 m	10'10"	—	—
Ground Clearance	496 mm	1'7.5"	606 mm	1'11"	574 mm	1'10.6"	591 mm	1'11"■
Blade Types and Widths:								
Straight	4.50 m	14'9"	—	—	—	—	—	—
Angle Straight	—	—	4.99 m	16'4"	—	—	—	—
Universal	—	—	4.26 m	14'0"	3.94 m	12'11"	4.65 m	15'3"
Semi-U	—	—	3.94 m	12'11"	4.52 m	14'10"	4.32 m	14'2"
Fuel Tank Refill Capacity	479 L	127 U.S. gal	625 L	165 U.S. gal	625 L	165 U.S. gal	818 L	216 U.S. gal

*Operating Weight includes ROPS canopy, operator, lubricants, coolant, full fuel tank, hydraulic controls and fluids, semi universal blade with tilt, back-up alarm, seat belts, lights, rigid drawbar and front towing device.

— D8R and D9R equipped with track guides, ROPS/FOPS cab, single shank ripper and SU blade.

**Height (stripped top) — without ROPS canopy, exhaust, seat back or other easily removed encumbrances.

***Includes drawbar.

■ SAE J1234



MODEL	D10R		D11R		D11R C.D.	
Flywheel Power	425 kW	570 hp	634 kW	850 hp	634 kW	850 hp
Operating Weight*	66 090 kg	145,690 lb	102 287 kg	225,500 lb	111 590 kg	246,000 lb
Engine Model	3412TA		3508BTA		3508BTA	
Rated Engine RPM	1900		1800		1800	
No. of Cylinders	12		8		8	
Bore	137 mm	5.4"	170 mm	6.7"	170 mm	6.7"
Stroke	152 mm	6"	190 mm	7.5"	190 mm	7.5"
Displacement	27 L	1649 in ³	34.5 L	2105 in ³	34.5 L	2105 in ³
Track Rollers (Each Side)	8		8		8	
Width of Standard Track Shoe	610 mm	2'0"	710 mm	2'4"	914 mm	3'0"
Length of Track on Ground	3.88 m	12'9"	4.44 m	14'7"	4.44 m	14'7"
Ground Contact Area (W/Std. Shoe)	4.7 m ²	7326 in ²	6.31 m ²	9781 in ²	8.11 m ²	12,276 in ²
Track Gauge	2.55 m	8'4"	2.89 m	9'6"	2.89 m	9'6"
GENERAL DIMENSIONS:						
Height (Stripped Top)**	3.267 m	10'6"	3.61 m	11'10"	3.61 m	11'10"
Height (To Top of ROPS Canopy)	—		—		—	
Height (To Top of ROPS)	4.36 m	14'3"	4.66 m	15'3"	4.66 m	15'3"
Overall Length (With SU Blade)	7.50 m	24'7"	8.38 m	27'6"	8.34 m	26'8"
(Without Blade)	5.33 m	17'6"	6.16 m	20'3"	6.16 m	20'3"
Width (Over Trunnions)	3.72 m	12'2"	4.37 m	14'4"	4.37 m	14'4"
Width (W/O Trunnions — Std. Shoe)	3.16 m	10'4"	3.60 m	11'10"	3.60 m	11'10"
Ground Clearance	615 mm	2'0.2"■	623 mm	2'0.5"■	623 mm	2'0.5"■
Blade Types and Widths:						
Straight	—		—		6.71 m	22'0"
Angle Straight/Angled	—		—		—	
Universal	5.26 m	17'3"	6.35 m	20'10"	—	
Semi-U	4.86 m	15'11"	5.60 m	18'4"	—	
"P" Straight/Angled	—		—		—	
Fuel Tank Refill Capacity	1109 L	293 U.S. gal	1471 L	388 U.S. gal	1471 L	388 U.S. gal

*Operating Weight includes operator, lubricants, coolant, full fuel tank, hydraulic controls and fluids, SU blade with tilt, back-up alarm, seat belts, lights, rigid drawbar and front towing device.

— D10R includes single shank ripper and ROPS cab.

— D11R includes 11U Dual Tilt Bulldozer, single shank ripper with pin puller, ROPS cab, fast fuel fill and engine doors.

— D11R C.D. includes 11D Dual Tilt Bulldozer, single shank ripper with pin puller, ROPS cab, fast fuel fill and engine doors.

**Height (stripped top) — without ROPS canopy, exhaust, seat back or other easily removed encumbrances.

■ SAE J1234

**D3C Series III
 D3C XL Series III
 D3C LGP Series III**

kg × 1000 lb × 1000

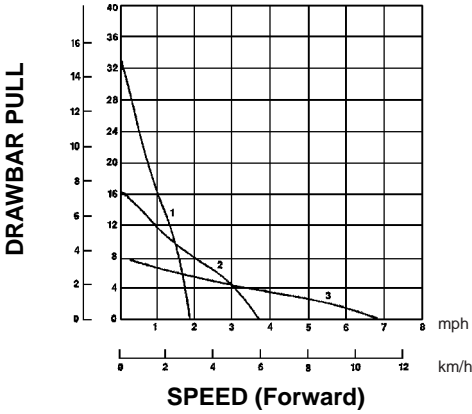

**D4C Series III
 D4C XL Series III
 D4C LGP Series III**

kg × 1000 lb × 1000

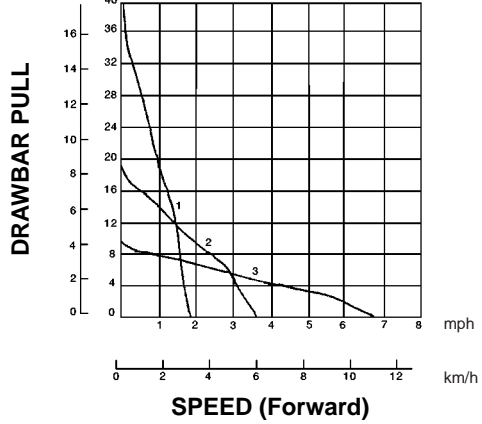

**D5C Series III
 D5C XL Series III
 D5C LGP Series III**

kg × 1000 lb × 1000

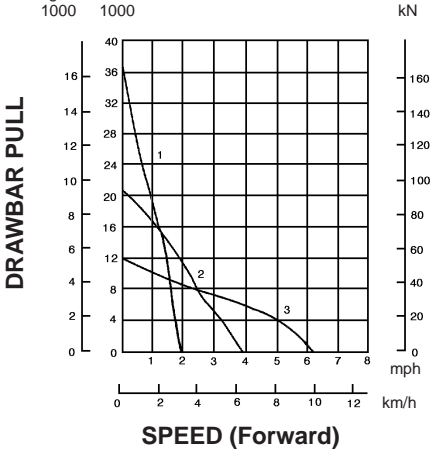

KEY

- 1 — 1st Gear
- 2 — 2nd Gear
- 3 — 3rd Gear

NOTE: Usable pull will depend upon weight and traction of equipped tractor.

Track-Type Tractors

Drawbar Pull vs. Ground Speed

- Hydrostatic Drive

D3C Series III
D3C XL Series III
D3C LGP Series III

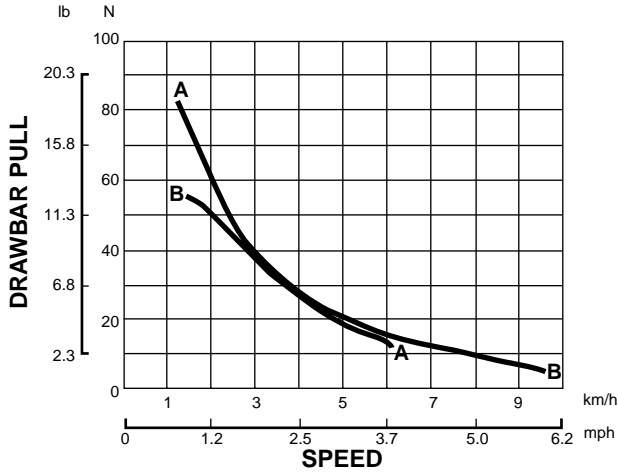

D4C Series III
D4C XL Series III
D4C LGP Series III

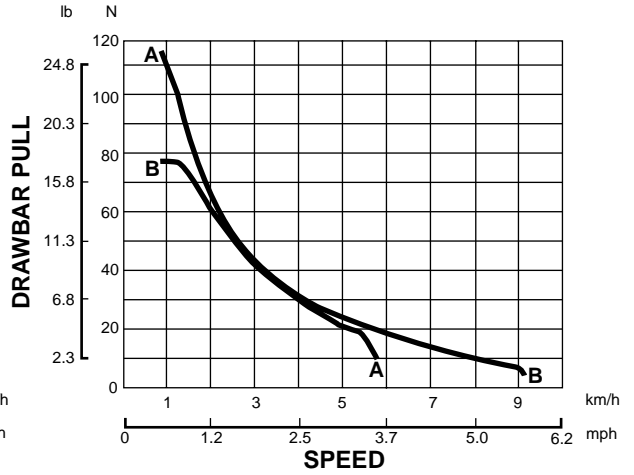

D5C Series III
D5C XL Series III
D5C LGP Series III

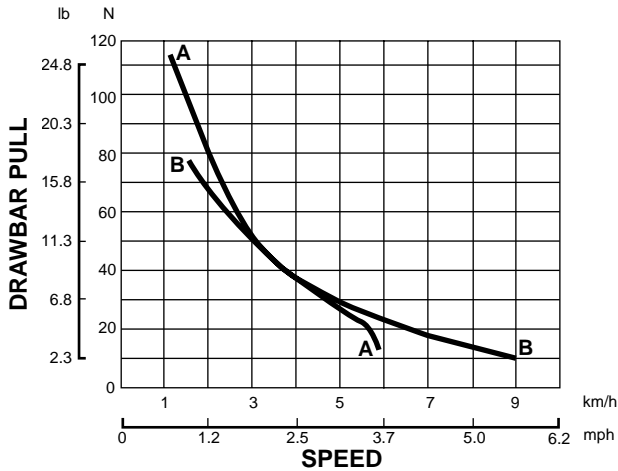

KEY

- A — Lo Speed
- B — Hi Speed

NOTE: Usable pull will depend upon weight and traction of equipped tractor.

**D5M XL
 D5M LGP**

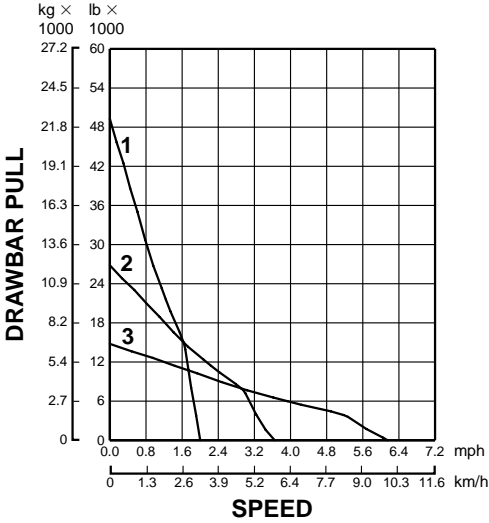

D5M LGP PSDD

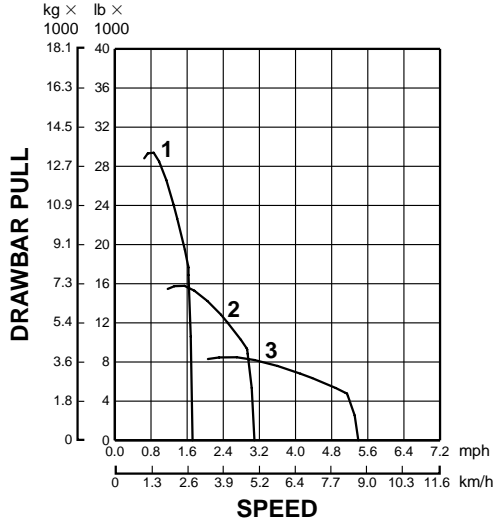

**D6M XL
 D6M LGP**

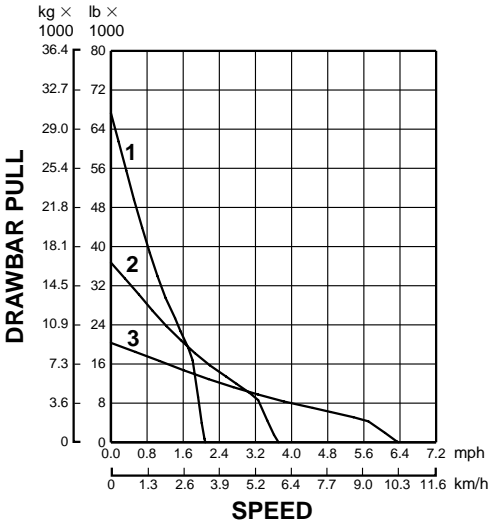

D6G

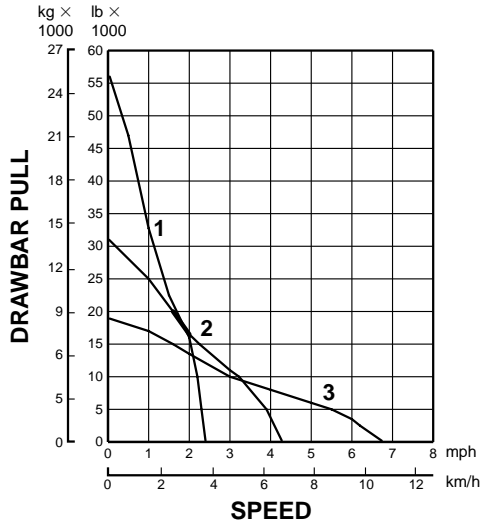

KEY

- 1 — 1st Gear
- 2 — 2nd Gear
- 3 — 3rd Gear

NOTE: Usable pull will depend upon weight and traction of equipped tractor.

**D6R Standard
 Steering Clutches & Brakes (FTC)**

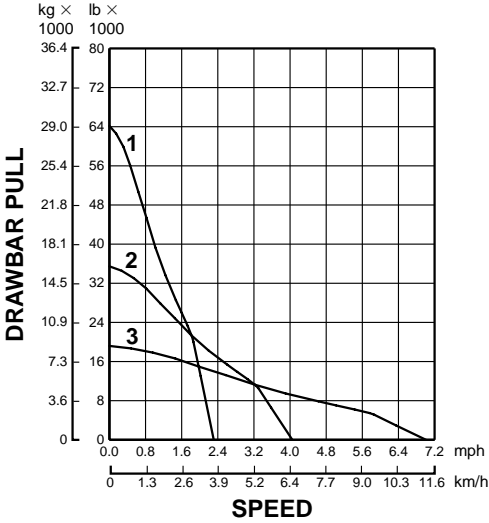

**D6R Standard
 Differential Steering**

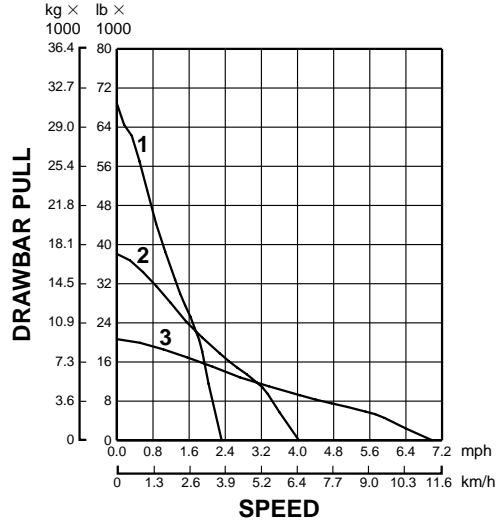

**D6R XL/XR/IG
 Steering Clutches & Brakes (FTC)**

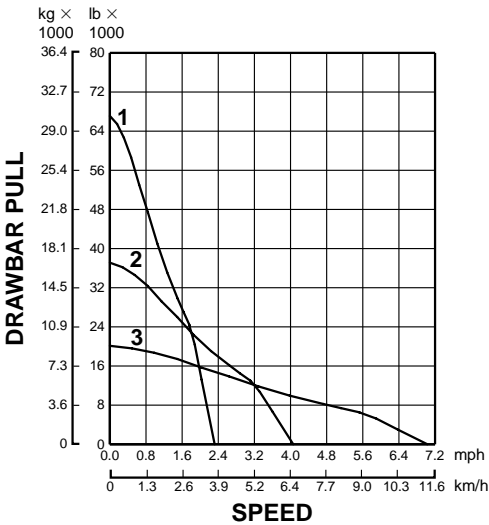

**D6R XL/XR/IG
 Differential Steering**

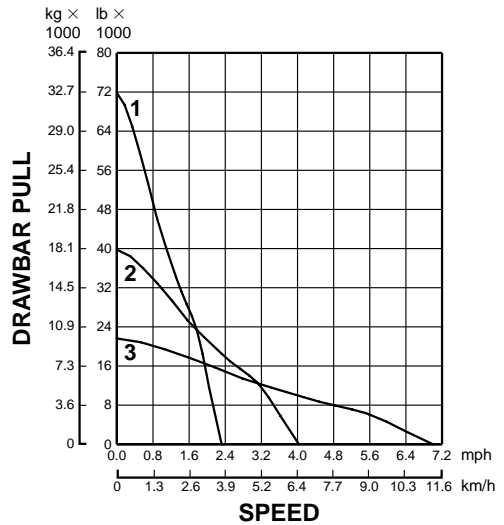

KEY

- 1 — 1st Gear
- 2 — 2nd Gear
- 3 — 3rd Gear

NOTE: Usable pull will depend upon weight and traction of equipped tractor.

D6R LGP
 Steering Clutches & Brakes (FTC)

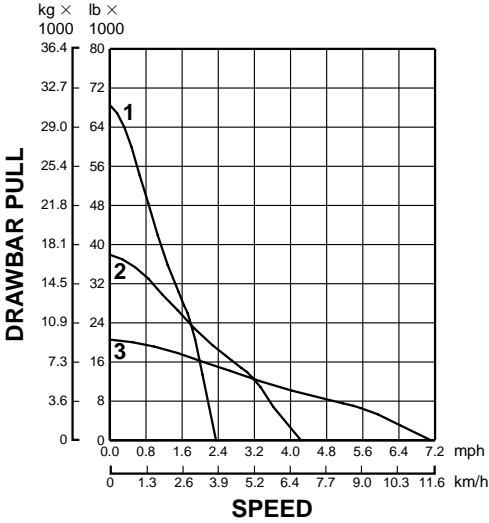

D6R LGP
 Differential Steering

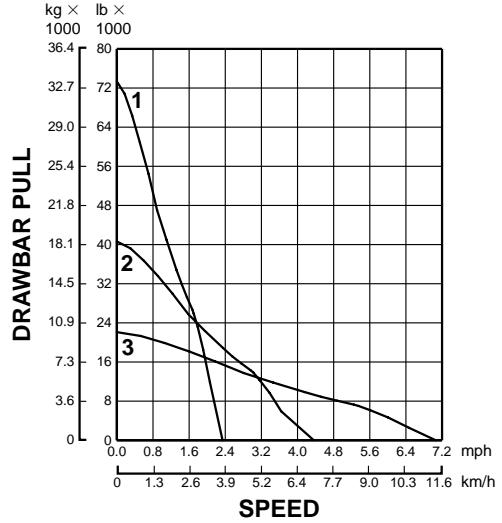

D7G

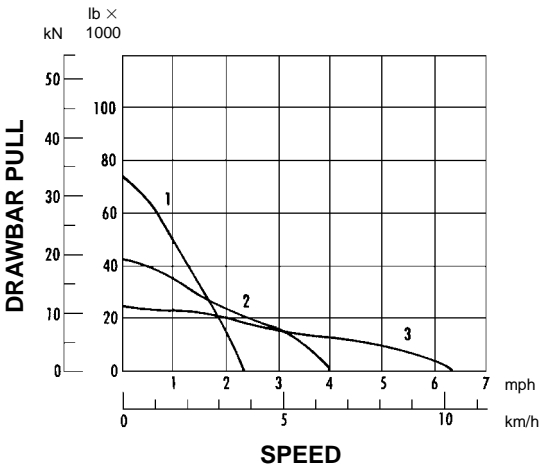

D7R Standard/XR/LGP (FTC)

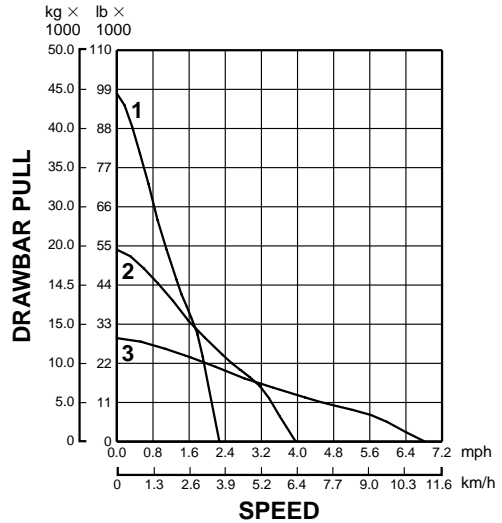

KEY

- 1 — 1st Gear
- 2 — 2nd Gear
- 3 — 3rd Gear

NOTE: Usable pull will depend upon weight and traction of equipped tractor.

D7R Standard/XR/LGP Differential Steering

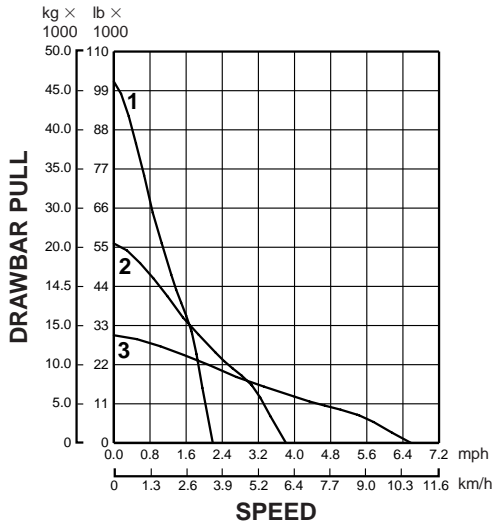

D8R D8R LGP

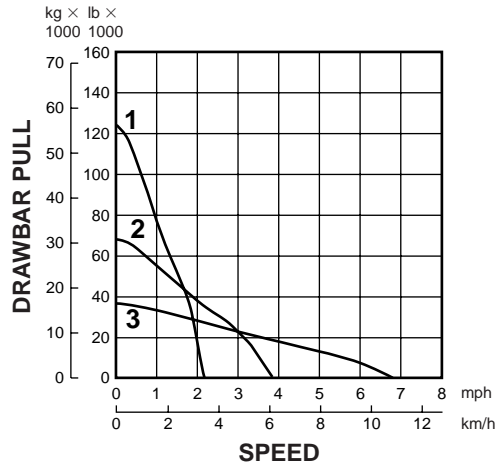

D9R Power Shift with Steering Clutches & Brakes

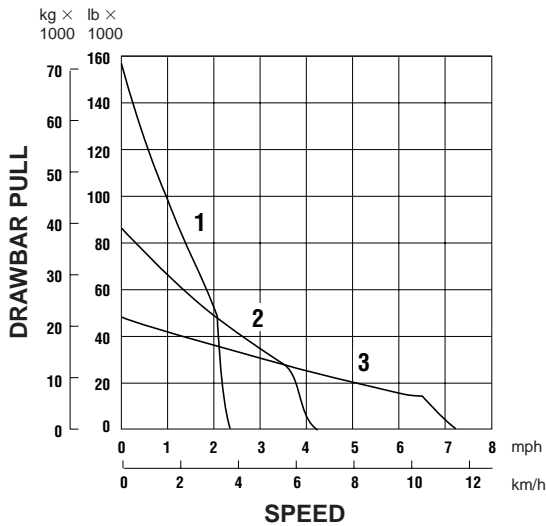

D9R Differential Steering

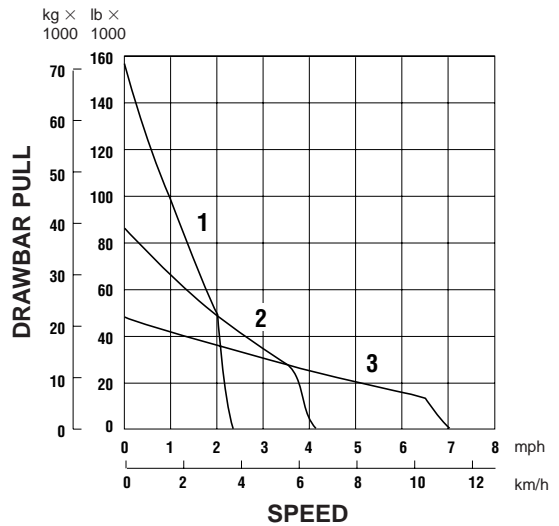

KEY
 1 — 1st Gear
 2 — 2nd Gear
 3 — 3rd Gear

NOTE: Usable pull will depend upon weight and traction of equipped tractor.

D10R

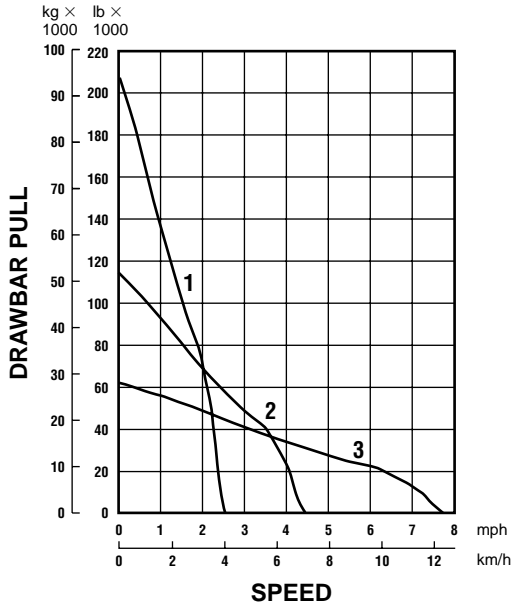

D11R

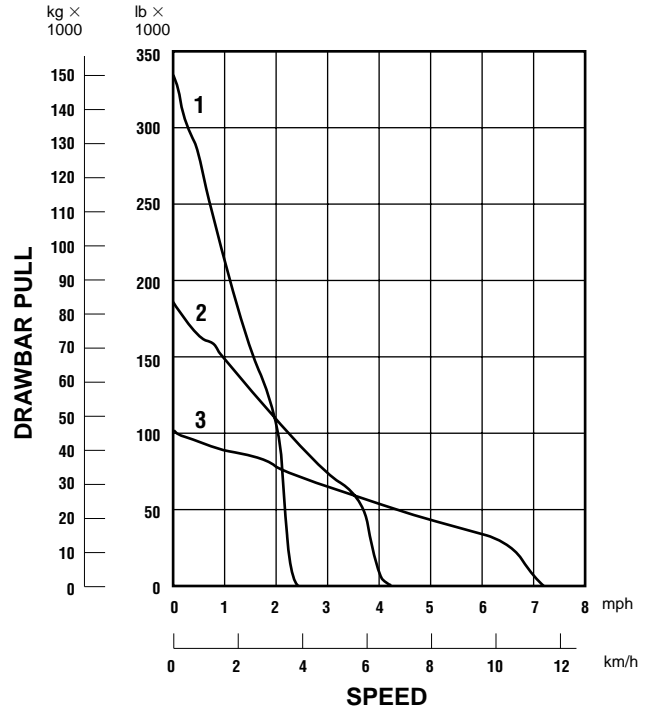

D11R C.D.

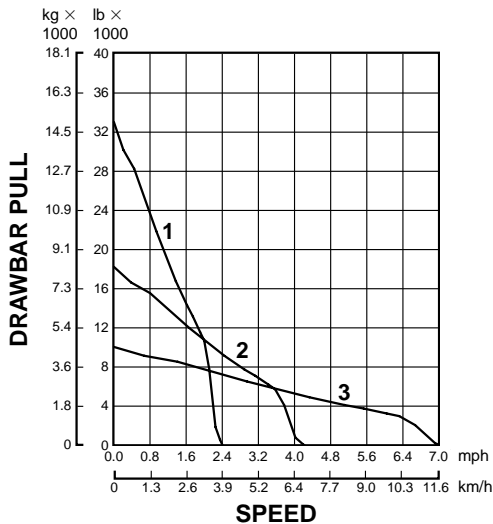

KEY

- 1 — 1st Gear
- 2 — 2nd Gear
- 3 — 3rd Gear

NOTE: Usable pull will depend upon weight and traction of equipped tractor. Tractors with suspended undercarriage can provide up to 15% more tractive effort than tractors with non-suspended undercarriage.

TRAVEL SPEED

POWER SHIFT MODEL	D3C Series III All Models		D4C Series III All Models		D5C Series III All Models		D5M XL		D5M LGP		D5M LGP* PS DD		D6M XL	
	km/h	mph	km/h	mph	km/h	mph	km/h	mph	km/h	mph	km/h	mph	km/h	mph
FORWARD														
1	3.1	1.9	3.2	2.0	3.5	2.2	3.1	1.9	3.1	1.9	2.8	1.7	3.4	2.1
2	5.9	3.7	5.9	3.7	6.3	3.9	5.6	3.5	5.6	3.5	5.0	3.1	6.0	3.7
3	10.8	6.7	11.1	6.9	10.0	6.2	9.7	6.1	9.7	6.1	8.7	5.4	10.2	6.4
REVERSE														
1	3.2	2.0	3.4	2.1	4.2	2.6	4.0	2.5	4.0	2.5			4.2	2.6
2	6.3	3.9	6.4	4.0	7.6	4.7	7.1	4.4	7.1	4.4	**		7.5	4.6
3	11.4	7.1	11.9	7.4	11.9	7.4	12.1	7.5	12.1	7.5			12.8	7.9
HYDROSTATIC FORWARD/ REVERSE	0-9.0	0-5.6	0-9.0	0-5.6	0-9.0	0-5.6	—	—	—	—	—	—	—	—

POWER SHIFT MODEL	D6M LGP		D6E		D6R (FTC) All Models		Differential Steer D6R All Models			D7R (FTC) All Models		Differential Steer D7R All Models		
	km/h	mph	km/h	mph	km/h	mph	km/h	mph	km/h	mph	km/h	mph	km/h	mph
FORWARD														
1	3.4	2.1	4.0	2.5	4.0	2.5	3.9	2.4	3.7	2.3	3.7	2.3	3.7	2.3
2	6.0	3.7	6.9	4.3	7.1	4.4	6.8	4.2	6.6	4.1	6.9	4.3	6.9	4.3
3	10.2	6.4	10.8	6.7	12.4	7.7	11.9	7.6	10.0	6.2	11.1	6.9	11.1	6.9
REVERSE														
1	4.2	2.6	4.8	3.0	5.2	3.2	4.8	3.0	4.5	2.8	4.8	3.0	4.8	3.0
2	7.5	4.6	8.4	5.2	9.0	5.6	8.7	5.4	7.9	4.9	8.3	5.2	8.3	5.2
3	12.8	7.9	12.9	8.0	16.1	10.0	15.3	9.5	12.2	7.6	14.2	8.8	14.2	8.8

POWER SHIFT MODEL	D8R D8R LGP		D9R		D10R		D11R		D11R C.D.	
	km/h	mph	km/h	mph	km/h	mph	km/h	mph	km/h	mph
FORWARD										
1	3.5	2.2	3.9	2.4	4.0	2.5	3.9	2.4	3.9	2.4
2	6.2	3.9	6.8	4.2	7.1	4.4	6.8	4.2	6.8	4.2
3	10.8	6.7	11.8	7.3	12.5	7.7	11.8	7.3	11.7	7.3
REVERSE										
1	4.7	2.9	4.8	3.0	5.0	3.1	4.7	2.9	4.7	2.9
2	8.1	5.0	8.4	5.2	8.9	5.5	8.2	5.1	8.2	5.1
3	13.9	8.6	14.7	9.1	15.6	9.7	14.0	8.7	14.0	8.7

*Power Shift direct drive transmission available for Japan domestic market only.

**Not available at time of printing.

TRAVEL SPEED

DIRECT DRIVE MODEL	D5E		D6R	
	Std. Trans.		Std. Trans.	
FORWARD	km/h	mph	km/h	mph
1	2.7	1.7	2.7	1.7
2	4.2	2.6	3.5	2.2
3	5.8	3.6	4.6	2.9
4	8.0	5.0	5.8	3.6
5	11.1	6.9	7.6	4.7
6	—	—	10.0	6.2
REVERSE				
1	3.4	2.1	3.3	2.1
2	5.3	3.3	4.3	2.7
3	7.4	4.6	5.6	3.5
4	10.1	6.3	7.1	4.4
5	—	—	9.2	5.7
6	—	—	12.2	7.6

DRAWBAR PULL FORWARD*

FORWARD	At Rated RPM			At Rated RPM		
	kN	kg	lb	kN	kg	lb
1	86.1	8770	19,340	122.5	12 500	27,530
2	54.0	5500	12,130	93.2	9520	20,960
3	36.8	3750	8270	70.0	7140	15,740
4	24.9	2540	5600	53.3	5440	11,990
5	16.3	1660	3660	39.3	4010	8830
6	—	—	—	27.6	2820	6210
	Max. at Lug			Max. at Lug		
1	109.2	11 130	24,540	159.0	16 220	35,750
2	69.1	7040	15,525	121.6	12 410	27,340
3	47.6	4850	10,695	91.9	9370	20,650
4	32.9	3350	7385	70.5	7200	15,860
5	22.1	2250	4960	52.5	5360	11,810
6	—	—	—	37.6	3840	8460

*Specified pull is based on nominal engine performance derated for transmission lube, control and optional implement hydraulic pumps, with corrections made for drive-line mechanical efficiency and rolling resistance on firm level ground. Usable pull will depend on particular attachments, weight and traction of equipped tractor.

NOTE: For Variable Horsepower Tractor Information, see the Agricultural Tractor section in this handbook.

TRAVEL SPEED

DIRECT DRIVE MODEL	D6R LGP		D7G		D7G	
	Std. Trans.		Std. Trans.		Opt. Trans.	
FORWARD	km/h	mph	km/h	mph	km/h	mph
1	2.7	1.7	2.6	1.6	3.5	2.2
2	3.5	2.2	3.7	2.3	4.8	3.0
3	4.6	2.9	5.3	3.3	5.6	3.5
4	5.8	3.6	7.9	4.9	6.4	4.0
5	7.6	4.7	10.3	6.4	7.2	4.5
6	10.0	6.2	—	—	8.2	5.1
REVERSE						
1	3.3	2.1	3.1	1.9	4.0	2.5
2	4.3	2.7	4.3	2.7	5.6	3.5
3	5.6	3.5	6.3	3.9	6.8	4.2
4	7.1	4.4	9.3	5.8	7.6	4.7
5	9.2	5.7	—	—	—	—
6	12.2	7.6	—	—	—	—

DRAWBAR PULL FORWARD*

FORWARD	At Rated RPM			At Rated RPM			At Rated RPM		
	kN	kg	lb	kN	kg	lb	kN	kg	lb
1	126.9	12 930	28,520	163.0	16 610	36,630	118.4	12 560	27,680
2	96.7	9850	21,730	109.9	11 200	24,690	83.5	8700	19,190
3	72.7	7410	16,330	73.4	7480	16,500	69.1	7110	15,680
4	55.4	5650	12,460	46.9	4780	10,540	60.5	6170	13,600
5	40.9	4170	9190	34.5	3510	7750	51.7	5190	11,450
6	28.8	2940	6480	—	—	—	45.1	4460	9840
		Max. at Lug			Max. at Lug			Max. at Lug	
1	168.8	17 200	37,930	209.8	21 390	47,150	153.0	16 080	35,440
2	129.2	13 170	29,030	142.2	14 500	31,960	108.7	11 260	24,830
3	97.7	9960	21,960	95.9	9770	21,550	90.4	9270	20,440
4	95.1	7660	16,880	62.1	6330	13,950	79.5	8040	17,840
5	56.1	5710	12,600	46.3	4710	10,400	68.3	6870	15,150
6	40.3	4100	9050	—	—	—	59.9	5960	13,130

*Specified pull is based on nominal engine performance derated for transmission lube, control and optional implement hydraulic pumps, with corrections made for drive-line mechanical efficiency and rolling resistance on firm level ground. Usable pull will depend on particular attachments, weight and traction of equipped tractor.

NOTE: For Variable Horsepower Tractor Information, see the Agricultural Tractor section in this handbook.

GROUND PRESSURES

Pressures computed from operating weights given earlier in this section in the specifications tables.

MODEL	SHOE WIDTH		CONTACT AREA		GROUND PRESSURE	
	mm	in	m ²	in ²	kPa	psi
D3C Series III	406	16	1.54	2390	44.7	6.49
D3C Hystat	406	16	1.54	2390	45.2	6.56
D3C XL Series III	406	16	1.67	2586	42.5	6.16
D3C XL Hystat	406	16	1.67	2586	42.9	6.23
D3C LGP Series III	635	25	2.61	4045	28.7	4.16
D3C LGP Hystat	635	25	2.61	4045	29.0	4.20
D4C Series III	406	16	1.67	2586	42.7	6.19
D4C Hystat	406	16	1.67	2586	43.0	6.25
D4C XL Series III	457	18	2.02	3131	36.2	5.25
D4C XL Hystat	457	18	2.02	3131	36.5	5.29
D4C LGP Series III	635	25	2.61	4045	29.0	4.21
D4C LGP Hystat	635	25	2.61	4045	29.2	4.24
D5C Series III	457	18	1.96	3039	42.1	6.11
D5C Hystat	457	18	1.96	3039	42.4	6.16
D5C XL Series III	508	20	2.35	3547	36.5	5.30
D5C XL Hystat	508	20	2.35	3547	36.7	5.33
D5C LGP Series III	660	26	2.83	4389	30.8	4.48
D5C LGP Hystat	660	26	2.83	4389	31.1	4.51
D5M XL	510	20	2.44	3775	48	6.83
	560	22	2.67	4146	44	6.22
D5M LGP	610	24	3.18	4922	40	5.64
	760	30	3.96	6133	32	4.53
	770	30	4.01	6213	31	4.47
D5E	406	16	1.77	2745	62	9.00
	457	18	1.99	3085	55	7.98
D6M XL	560	22	2.89	4427	52	7.49
	600	24	3.06	4743	48	6.99
D6M LGP	710	28	4.38	6783	37	5.36
	860	34	5.30	8217	31	4.43
	865	34	5.33	8264	30	4.40
D6G	457	18	2.43	3766	60	8.70
	508	20	2.71	4200	54	7.83
	560	22	2.98	4619	49	7.10
	610	24	3.25	5040	45	6.54
D6R	560	22	2.92	4518	61	8.82
	610	24	3.18	4930	56	8.14

◀ Standard Shoe.

MODEL	SHOE WIDTH		CONTACT AREA		GROUND PRESSURE	
	mm	in	m ²	in ²	kPa	psi
D6R XL	560	22	3.16	4888	60	8.60
	610	24	3.44	5332	55	7.93
D6R XL (IG)	762	30	4.30	6696	44	6.50
D6R XR	560	22	3.08	4770	60	8.68
	610	24	3.36	5203	56	8.01
D6R LGP	760	30	4.93	7662	41	5.80
	915	36	5.93	9194	35	4.94
	1000	39	6.49	9961	32	4.55
D7G	508	20	2.76	4280	73	10.60
	559	22	3.04	4708	66	9.60
	610	24	3.31	5136	60	8.80
D7R	510	20	2.94	4560	82	11.71
	560	22	3.24	5016	75	10.69
	610	24	3.53	5472	69	9.87
	660	26	3.82	5928	64	9.17
D7R XR	560	22	3.43	5315	71.5	10.16
	610	24	3.75	5808	65.9	9.37
	660	26	4.06	6282	61.2	8.70
D7R LGP	760	30	4.80	7504	54	7.74
	915	36	5.82	9029	46	6.55
D8R	560	22	3.59	5565	101.1	14.67
	610	24	3.91	6062	92.8	13.47
	660	26	4.23	6559	85.9	12.47
	710	28	4.55	7056	79.7	11.57
D8R LGP	965	38	6.20	9576	58.6	8.50
D9R	560	22	3.86	6009	121.1	17.58
	610	24	4.24	6569	110.8	16.08
	685	27	4.74	7374	98.7	14.32
	760	30	5.26	8194	88.8	12.89
D10R	610	24	4.73	7326	136.4	19.79
	710	28	5.50	8527	117.1	17.00
	860	31.5	6.66	10,328	96.7	14.04
D11R	710	28	6.31	9781	158.8	23.05
	810	32	7.20	11,159	139.2	20.21
	915	36	8.13	12,605	123.2	17.89

◀ Standard shoe.

NOTE: Ground contact area = width of track shoe × length of track on ground × 2.

$$\text{Ground pressure} = \frac{\text{operating weight}}{\text{ground contact area}}$$

EXTREME SLOPE OPERATION

The following table gives the MAXIMUM fore and aft slope on which each tractor will have proper lubrication. Consult Operation & Maintenance Manual (if applicable) for POWER TRAIN fluid level overfill requirements for operation on extreme slopes. Extreme slope operation is anytime the slope exceeds 25° (47%).

Tractor	D3C Series III		D4C Series III		D5C Series III		D5M		D5E & D6M	
	Percent Grade or Degrees Slope	100	100	100	100	100	100	100	100	100
	45	45	45	45	45	45	45	45	45	45

Tractor	D6G & D6R		D7G & D7R		D8R		D9R		D10R		D11R/ D11R C.D.	
	Percent Grade or Degrees Slope	100	100	100	100	100	100	100	100	100	100	100
	45	45*	45*	45*	45	45	45	45	45	45	45	45

The ENGINE should never be overfilled with oil. This may lead to rapid overheating. For extreme slope operation, engine oil should be maintained at the full mark.

NOTE: Both ENGINE and POWER TRAIN fluid levels should be checked on level ground before working sidehills and slopes.

When working sidehills and slopes, consideration should be given to the following important points:

- Speed of travel — At higher speeds, inertia forces tend to make the tractor less stable.
- Roughness of terrain or surface — Ample allowance should be made where the terrain or surface is uneven.
- Mounted equipment — Bulldozers, sidebooms, winches, and other mounted equipment cause the tractor to balance differently.
- Nature of surface — New earthen fills may give way with the weight of the tractor. Rocky surfaces may promote side slipping of tractor.
- Track slippage due to excessive loads — This may cause downhill track to “dig in,” increasing angle of tractor.

- Implements hitched to the drawbar — This may decrease weight on uphill track, e.g., logging arch, two-wheel wagon.
- Height of hitch on tractor — When a high drawbar is used the tractor is less stable than with the standard drawbar.
- Width of shoes — Wide track shoes tend to decrease “digging in”, hence tractor is more stable.
- Operated equipment — Be aware of the stability and other performance features of the equipment operated by the tractor.
- Keep all attachments or pulled loads low to the ground for optimum stability.

*The D7G requires a 23 L (6 gal) transmission overfill for acceptable operation on slopes above 25° (47%).

NOTE: Safe operation on steep slopes may require special machine maintenance as well as excellent operator skill and proper equipment for the specific application. Consult Operation & Maintenance Manual (if applicable) for proper fluid level requirements.

WASTE HANDLING TRACK-TYPE TRACTORS

CONTENTS

Features	1-25
Specifications	1-26
Bulldozer specifications	1-28

Features:

- **Hinged heavy duty radiator** doors are guarded to prevent excessive trash build-up. Quick release handles allow easy access for cleaning.
- **Final drive, pivot shaft, and idler seal guarding** helps prevent wire, cable and similar material from winding around components and damaging seals.
- **Striker bars for front, rear and ripper** (all optional) keep trash from damaging fenders, fuel and hydraulic tanks or other sheet metal.
- **Lighting protection.** Front lights are mounted on top of bulldozer lift cylinders. Rear lights are ROPS mounted.
- **AMOCS Waste Handling Arrangement** radiator with 6 fins/inch (optional on D6R thru D9R).
- **Flexxaire fan** is recommended option for D6R thru D9R.
- **Elevated sprocket** removes final drives from wear environment and eliminates impact loading for extended power train life.
- **Sheet metal guarding** near track and on dozer tilt hoses.
- **Heavy duty steps and grab handles** resist damage from landfill debris.
- **Trapezoidal-shaped center hole track shoes (optional)** help keep track clean during machine operation.
- **Blade trash racks (optional)** prevent blade spill-over and damage to cylinders or radiator guard.
- **75 amp alternator available on D6R, D7R, D8R, D9R, 100 amp on D10R** insures adequate current is available to maintain battery and operate accessories.
- **Elevated prescreener** to remove engine air inlet from debris environment. Larger surface area to resist plugging. Turbine precleaner is optional.
- **ROPS mounted air conditioning (optional on D8R and D9R)** helps prevent condensor core plugging. Provides full utilization of jacket water cooling system by avoiding additional heat load from radiator mounted condensor.
- **Chassis Guards.**
- **Sealed belly guards** on D10R.
- **Perforated engine enclosures** standard on D10R and required attachments on D6R thru D9R.
- **Carrier rollers** not recommended.



MODEL	D6R WHA		D7R WHA	
Flywheel Power	123 kW	165 hp	171 kW	230 hp
Operating Weight (PS)*	20 600 kg	45,370 lb	27 920 kg	61,500 lb
Engine Model		3306		3306
Rated Engine RPM		1800		2100
No. of Cylinders		6		6
Bore	121 mm	4.75"	121 mm	4.75"
Stroke	152 mm	6"	152 mm	6"
Displacement	10.5 L	638 in³	10.5 L	638 in³
Track Rollers (Each Side)		6		7
Width of Standard Track Shoe	560 mm	1'10"	560 mm	1'10"
Length of Track on Ground	2.62 m	8'7.5"	2.88 m	9'5"
Ground Contact Area (W/Std. Shoe)	2.94 m ²	4564 in²	3.22 m ²	4996 in²
Track Gauge	1.88 m	6'2"	1.98 m	6'5"
GENERAL DIMENSIONS:				
Height (Stripped Top)**	2.26 m	7'5"	2.56 m	8'5"
Height (To Top of Cab ROPS)	3.12 m	10'3"	3.50 m	11'6"
Overall Length (S Blade) (W/O Blade)	5.11 m	16'9"	5.82 m	19'1"
Width (Over Trunnion)	2.64 m	8'8"	2.87 m	9'5"
(W/O Trunnion)		—	2.54 m	8'4"
Ground Clearance	376 mm	14.8"	414 mm	16"
Blade Types and Widths:				
Straight	3.35 m	11'0"	3.90 m	12'10"
Semi-Universal	3.26 m	10'8"	3.69 m	12'1"
Universal		—	3.98 m	13'0"
Fuel Tank Refill Capacity	383 L	101 U.S. gal	488 L	129 U.S. gal

*D6R Operating Weight includes lubricants, coolant, full fuel tank, hydraulic controls, 6SU/tilt, 610 mm (2'0") trash rack, 560 mm (1'10") shoes, ROPS canopy, engine enclosure, extreme service crankcase guard, fuel tank guard, hydraulic cooler, prescreener, six lights, hinged HD radiator guard, lower radiator guarding, final drive seal guards, idler seal guards, engine compartment guarding, tilt cylinder guards. WHA also available for D6R XL, XR, XL (IG) and LGP models.

D7R Operating Weight includes lubricants, coolant, full fuel tank, hydraulic controls, 7SU/tilt, 610 mm (2'0") trash rack, 560 mm (1'10") shoes, ROPS canopy, engine enclosure, extreme service crankcase guard, fuel tank guard, hydraulic cooler, prescreener, six lights, hinged HD radiator guard, lower radiator guarding, final drive seal guards, idler seal guards, engine compartment guarding, tilt cylinder guards. WHA also available for D7R XR and D7R LGP.

**Height with ROPS canopy, exhaust pipe, seat or all easily removed encumbrances. Add 71.1 mm (2.8") for grouser tips on D7R.



MODEL	D8R WHA		D9R WHA		D10R WHA	
Flywheel Power	228 kW	305 hp	302 kW	405 hp	425 kW	570 hp
Operating Weight (PS)*	37 594 kg	82,880 lb	47 913 kg	105, 630 lb	65 764 kg	144,986 lb
Engine Model	3406C		3408E		3412	
Rated Engine RPM	2100		1900		1900	
No. of Cylinders	6		8		12	
Bore	137 mm	5.4"	137 mm	5.4"	137 mm	5.4"
Stroke	165 mm	6.5"	152 mm	6"	152 mm	6"
Displacement	14.6 L	893 in³	18 L	1099 in³	27 L	1649 in³
Track Rollers (Each Side)	8		8		8	
Width of Standard Track Shoe	560 mm	1'10"	610 mm	2'0"	610 mm	2'0"
Length of Track on Ground	3.21 m	10'6.5"	3.47 m	11'5"	3.88 m	12'9"
Ground Contact Area (W/Std. Shoe)	3.58 m ²	5544 in²	4.24 m ²	6569 in²	4.70 m ²	7326 in²
Track Gauge	2.08 m	6'10"	2.25 m	7'5"	2.55 m	8'4"
GENERAL DIMENSIONS:						
Height (Stripped Top)**	2.67 m	8'9"	3.00 m	9'10"	3.27 m	10'9"
Height (To Top of Cab ROPS)	3.51 m	11'6"	3.99 m	13'1"	4.36 m	14'3"
Overall Length (Blade)	6.39 m	21'0"	6.84 m	22'5"	7.76 m	25'5"
(W/O Blade)	4.88 m	16'2"	5.18 m	17'0"	5.59 m	18'4"
Width (Over Trunnion)	3.05 m	10'0"	3.30 m	10'10"	3.72 m	12'2"
(W/O Trunnion)	2.70 m	8'8"	2.93 m	9'8"	3.16 m	10'4"
Ground Clearance	585 mm	1'11"	585 mm	1'11"	615 mm	2'0.2"
Blade Types and Widths:						
Semi-Universal	3.94 m	12'11"	4.31 m	14'2"	—	—
Universal	4.26 m	14'0"	4.66 m	15'3.4"	5.26 m	17'3"
Fuel Tank Refill Capacity	625 L	165 U.S. gal	818 L	216 U.S. gal	1109 L	293 U.S. gal

*Operating Weight includes lubricants, coolant, full fuel tank, hydraulic controls, and ROPS — FOPS canopy. Also included are special radiator core and ejector fan, draw-bar, engine enclosures, fuel tank guard, extreme service crankcase guard, HD hinged radiator guard, higher prescreener, front & rear striker bars and operator.

— D8R 8S blade with 762 mm (2'6") trash rack and 660 mm (2'2") track shoes

— D9R 9SU blade with 914 mm (3'0") trash rack and 685 mm (2'3") track shoes

— D10R 10SU blade with 1107 mm (3'8") trash rack and 610 mm (2'0") track shoes.

**Height with ROPS canopy, exhaust pipe, seat or all easily removed encumbrances.

MODEL	D6R WHA			
Type	6S		6SU	
Blade Capacities*	8.6 m ³	11.2 yd³	11.2 m ³	14.6 yd³
Dozer Weight**	2881 kg	6338 lb	3026 kg	6657 lb
Tractor & Dozer Dimensions				
Length Blade Straight	5.11 m	16'9"	5.30 m	17'5"
Length Blade Angled	—	—	—	—
Width Blade Angled	—	—	—	—
Width C Frame Only	—	—	—	—
Blade Dimensions				
Width including std. end bits	3355 mm	11'0"	3262 mm	10'8"
Height	1866 mm	6'1"	2019 mm	6'7"
Maximum Dig Depth	473 mm	18.6"	473 mm	18.6"
Ground Clearance at full raise	1104 mm	3'7.5"	1104 mm	3'7.5"
Maximum Manual Tilt	—	—	—	—
Maximum Pitch	—	—	—	—
Maximum Hydraulic Tilt	765 mm	2'6.1"	744 mm	2'5.3"
Blade Angle	—	—	—	—

MODEL	D7R WHA					
Type	7S		7SU		7U	
Blade Capacities*	10.9 m ³	14.2 yd³	14.0 m ³	18.4 yd³	16.8 m ³	22.0 yd³
Dozer Weight**	4028 kg	8861 lb	4083 kg	8982 lb	4402 kg	9684 lb
Tractor & Dozer Dimensions						
Length Blade Straight	5813 mm	19'1"	6036 mm	19'10"	6278 mm	20'7"
Length Blade Angled	—	—	—	—	—	—
Width Blade Angled	—	—	—	—	—	—
Width C Frame Only	—	—	—	—	—	—
Blade Dimensions						
Width including std. end bits	3904 mm	12'10"	3690 mm	12'1"	3980 mm	13'1"
Height	1971 mm	6'6"	2133 mm	7'0"	2162 mm	7'1"
Maximum Dig Depth	527 mm	1'8.7"	527 mm	1'8.7"	527 mm	1'8.7"
Ground Clearance at full raise	1145 mm	3'9.1"	1145 mm	3'9.1"	1145 mm	3'9.1"
Maximum Manual Tilt	—	—	—	—	—	—
Maximum Pitch	—	—	—	—	—	—
Maximum Hydraulic Tilt	845 mm	2'9.3"	861 mm	2'9.9"	799 mm	2'7.5"
Blade Angle	—	—	—	—	—	—

*Blade capacities, weights and heights include 610 mm (2'0") trash rack on D6R blades and D7R blades.

**Total bulldozer arrangement includes blade with trash rack, pusharms, braces, cylinders, lines, trunnions and lift cylinder mountings.

MODEL	D8R WHA			
Type	8SU		8U	
Blade Capacities*	20.0 m ³	26.1 yd³	24.8 m ³	32.4 yd³
Dozer Weight**	5466 kg	12,025 lb	6313 kg	13,888 lb
Tractor & Dozer Dimensions				
Length Blade Straight	6.39 m	21'0"	6.79 m	22'3"
Length Blade Angled	—	—	—	—
Width Blade Angled	—	—	—	—
Width C Frame Only	—	—	—	—
Blade Dimensions				
Width including std. end bits	3942 mm	12'11"	4262 mm	14'0"
Height	2464 mm	8'1"	2515 mm	8'3"
Maximum Dig Depth	582 mm	1'10.9"	582 mm	1'10.9"
Ground Clearance at full raise	1231 mm	4'0.5"	1231 mm	4'0.5"
Maximum Manual Tilt	—	—	—	—
Maximum Pitch	—	—	—	—
Maximum Hydraulic Tilt	951 mm	3'1.4"	1028 mm	3'4.5"
Blade Angle	—	—	—	—

MODEL	D9R WHA				D10R WHA	
Type	9SU		9U		10U	
Blade Capacities*	28.8 m ³	37.6 yd³	33.5 m ³	43.8 yd³	48.9 m ³	63.9 yd³
Dozer Weight**	6964 kg	15,353 lb	7662 kg	16,891 lb	—	—
Tractor & Dozer Dimensions						
Length Blade Straight	6.84 m	22'5"	7.18 m	23'7"	8.01 m	26'3"
Length Blade Angled	—	—	—	—	—	—
Width Blade Angled	—	—	—	—	—	—
Width C Frame Only	—	—	—	—	—	—
Blade Dimensions						
Width including std. end bits	4314 mm	14'2"	4645 mm	15'3"	5260 mm	17'3"
Height	2845 mm	9'4"	2845 mm	9'4"	3174 mm	10'5"
Maximum Dig Depth	606 mm	1'11.9"	606 mm	1'11.9"	679 mm	2'2.5"
Ground Clearance at full raise	1422 mm	4'8"	1422 mm	4'8"	1497 mm	4'10.9"
Maximum Manual Tilt	—	—	—	—	—	—
Maximum Pitch	—	—	—	—	—	—
Maximum Hydraulic Tilt	940 mm	3'1"	1014 mm	3'3.9"	1074 mm	3'6.3"
Blade Angle	—	—	—	—	—	—

*Blade capacities, weights and heights include 762 mm (2'6") trash rack on D8R blades, 914 mm (3'0") trash rack on D9R blades, and 1067 mm (3'6") trash rack on D10R blades.
**Total bulldozer arrangement includes blade with trash rack, pusharms, braces, cylinders, lines, trunnions and lift cylinder mountings.

HYDRAULIC CONTROLS

CONTENTS

Features1-31
 Specifications1-32

Features:

- **Designed and built for specific vehicle applications.** Valves and components sized for exacting quality and performance.
- **Job requirements matched** through various arrangements.
- **Pressure compensated control valves** for ease of operation on D6R thru D9R. Pilot operated on D10R and D11R tractors except for dozer lift which is pressure compensated and manually operated.
- **Full flow filters***... all oil completely filtered.
- **Dual tilt** — standard on D11R, optional on D9R and D10R.

*Exception — D8R 2-pump

MODEL	D3C Series III and Hystat	D4C Series III and Hystat	D5C Series III and Hystat
Mounting Point	Fender		Fender
Number of Valves	3 or 4		3 or 4
Flow at 6890 kPa (1000 psi)	66.6 L/min @ 2400 RPM	17.6 gpm	66.6 L/min @ 2400 RPM
Tank Capacity (Oil)	57 L	15 U.S. gal	57 L
Lift Relief Valve Setting	17 241 kPa	2500 psi	17 241 kPa
Weight Installed (Four Valves)	16 kg	36 lb*	16 kg

MODEL	D5M	D6M
Mounting Point	Right Rear Fender	
Number of Valves	3 or 4	
Flow at 6890 kPa (1000 psi)	95 L/min @ 2200 RPM	25 gpm
Tank Capacity (Oil)	32 L	8.5 U.S. gal
Lift Relief Valve Setting	20 700 kPa	3000 psi
Weight Installed	216 kg	440 lb
	(Four Valves)	(Four Valves)

MODEL	D6G	D6R	D6R (Differential Steer)
Mounting Point	Dash	Under Operators Platform	Under Operators Platform
Number of Valves	1, 2 or 3	2 or 3	2 or 3
Flow at 6890 kPa (1000 psi)	167 L/min @ 1900 RPM	44 gpm	193 L/min @ 1900 RPM
Tank Capacity (Oil)	49 L	13 U.S. gal	47.3 L
Lift Relief Valve Setting	15 500 kPa	2250 psi	19 305 kPa
Weight Installed	318 kg	700 lb	311 kg
	(Two Valves)	(Four Valves)	(Two Valves)

MODEL	D7G (173B)	D7R	D7R (Differential Steer)
Mounting Point	Fender		Under Operators Platform
Number of Valves	1, 2 or 3		2 or 3
Flow at 6890 kPa (1000 psi)	227 L/min @ 2080 RPM	60 gpm	175 L/min @ 2100 RPM (ENG.)
Tank Capacity (Oil)	91 L	24 U.S. gal	66.2 L
Lift Relief Valve Setting	15 500 kPa	2250 psi	22 750 kPa
Weight Installed	458 kg	1010 lb	358 kg
	(Two Valves)	(Two Valves)	(Two Valves)

*Hydraulic tank not included.

NOTE: Weight installed, two valves, includes pump, tank with filters, valves, lines, linkage, oil cooler and control levers. D3C Series II weight does not include hydraulic tank.

MODEL	D8R	D9R	D10R
Mounting Point	Under Operators Platform	Under Operators Platform	Under Operators Platform
Number of Valves	3 Ripper◀ Requires optional electronic diverter	4 + Dual Tilt (Attach.) Radiator Guard	2 At Rear Under Fuel Tank 2◀ + Dual Tilt (Attach.) Radiator Guard
Flow at 6890 kPa (1000 psi)	239 L/min 63 gpm @ 2100 RPM	235 L/min 62.1 gpm @ 1900 RPM	408 L/min 107.8 gpm @ 1900 RPM
Tank Capacity (Oil)	72 L 19 U.S. gal	77.2 L 20.4 U.S. gal	108 L 28.6 U.S. gal
Lift Relief Valve Setting	24 100 kPa 3500 psi	26 200 kPa 3800 psi	18 616 kPa 2700 psi
Weight Installed (Two Valves)	Included in Std. Tractor	Included in Std. Tractor	Included in Std. Tractor

MODEL	D11R	D11R C.D.
Mounting Point	Under Operators Platform	Under Operators Platform
Number of Valves	2 At Rear Under Seat 2◀ + Dual Tilt (Attach.) Radiator Guard	2 At Rear Under Seat 2◀ Dual Tilt Standard Quick Dump Valve Standard Both on Radiator Guard
Flow at 6890 kPa (1000 psi)	620 L/min 164 gpm @ 1890 RPM	620 L/min 164 gpm @ 1890 RPM
Tank Capacity (Oil)	205 L 54 U.S. gal	205 L 54 U.S. gal
Lift Relief Valve Setting	22 750 kPa 3300 psi	24 115 kPa 3500 psi
Weight Installed (Two Valves)	Included in Std. Tractor	Included in Std. Tractor

◀ Ripper valve.

NOTE: Weight installed, two valves, includes pump, tank with filters, valves, lines, linkage, oil cooler and control levers.

BULLDOZERS

CONTENTS

Features	1-35
Summary of blade options	1-36
Blade selection/SAE definition	1-37
General dimensions (Tractor and Blade)	1-40
Blade specifications	1-41
Estimating bulldozer production off-the-job	1-49
Job condition correction factors	1-53
Measuring production on-the-job	1-54
Special attachments	1-54

Features:

- **Straight Bulldozers** — adjustable pitch angle controls blade penetration.
- **Power Angle and Tilt blades** for D3C Series III, D4C Series III and D5C Series III. D5M and D6M are designed for finish grading, backfilling ditches, cutting V ditches, windrowing, fill spreading, landscaping, medium duty land clearing and heavy dozing.
- **Variable cutting edge Power Angle and Tilt (VPAT)** — blade is available on the D5M and D6M. The blade can be mechanically tipped forward for improved penetration or back for more productivity and easier finish grading.
- **Angling Bulldozers** — 25° right/left angling; C-frame allows mounting other tools.
- **Universal Bulldozers** — 25° wings provide increased capacity, less spillage.
- **Semi-Universal Bulldozers** — combines penetration ability of straight blade with increased load capacity provided by short 25° wings.
- **Wheel Dozer blades** are straight design, with hydraulic pitch and tilt control.
- **Box-section construction** on blades adds rigidity and strength.
- **Cutting edges** are heat treated and reversible for extra life.

CATERPILLAR BLADES

SPECIAL ATTACHMENTS

MODEL	S	U	SU	A	FS	LFS	P	RC	WC	CL	HU	LF	TW	CU	CPB	CB	VR	WCB	CS	WCS	W	
D3C Series III							●						●									
D4C Series III							●						●									
D3C LGP Series III							●						●									
D4C LGP Series III							●						●									
D4E SR				●									●									
D5C Series III							●						●									
D5C LGP Series III							●						●									
D5M XL							●						●									
D5M LGP							●						●									
D5E				●									●									
D6M XL			●				●						●									
D6M LGP							●						●									
D6R	●		●	●			●	●	●	●	●	●	●				●					
D6R XL			●	●									●									
D6R LGP	●							●	●			●	●									
D6R IG			●	●									●									
D6G	●			●					●	●	●	●	●				●					
D7R	●	●	●	●				●	●	●	●	●	●				●					
D7R LGP	●											●	●				●					
D7G	●	●		●				●	●	●	●	●	●	●	●	●	●	●	●	●	●	●
D8R		●	●	●				●	●	●	●	●		●	●	●	●	●				
D8R LGP																						
D9R		●	●					●	●			●		●	●		●	●			●	
D10R		●	●					●	●	●				●	●	●	●	●				
D11R		●	●					●		●							●					
814F	●				●				●	●	●									●	●	
815F																						
816F						●						●										●
824G	●								●	●	●									●	●	
825G					●																	
826G						●						●										●
834B	●	●							●	●										●	●	
836												●										●

CATERPILLAR SUPPLIED

- S — Straight
- U — Universal
- SU — Semi-Universal
- A — Angling
- FS — Fill Spreading
- LFS — Landfill Spreading
- P — Power Angle Tilt

SPECIAL ATTACHMENTS SUPPLIED

- RC — Reclamation U
- WC — Woodchips
- CL — Coal
- HU — Heavy U
- LF — Landfill
- TW — Two-Way Dozer
- CU — Cushion Dozer
- CPB — Cushion Push Block
- CB — Coal Bowldozer
- VR — Variable Radius
- WCB — Wood Chip Bowldozer
- CS — Coal Scoop
- WCS — Wood Chip Scoop
- W — W-Blade

NOTE: This chart suggests a range of blade options for Caterpillar built machines. It is not totally inclusive of all blades available. For additional information consult Caterpillar Attachment Products and Services.

BLADE SELECTION

Properly matching tractor and dozer is a basic requirement for maximizing production. First consider the kind of work the tractor will be doing most of its life. Then evaluate:

- Material to be moved.
- Tractor limitations.

Materials to be moved.

Most materials are dozeable. However, dozer performance will vary with material characteristics such as:

Particle Size & Shape — The larger the individual particle size, the harder it is for a cutting edge to penetrate. Particles with sharp edges resist the natural rolling action of a dozer blade. These particles require more horsepower to move than a similar volume of material with rounded edges.

Voids — Few voids or the absence of voids means the individual particles have most or all of their surface area in contact with other particles. This forms a bond which must be broken. A well graded material, which lacks voids, is generally heavy, and will be hard to remove from the bank state.

Water Content — In most materials the lack of moisture increases the bond between particles and makes the material difficult to remove from the bank state. A high moisture content makes dozing difficult because the material is heavy and requires more force to move. Optimum moisture reduces dust and offers the best condition for dozing ease and operator comfort.

The effect of freezing depends on the moisture content. When frozen, the material's bond strengthens as moisture content increases and temperature decreases. However, freezing a completely dry material does not change its characteristics.

An indication of a blade's ability to penetrate and obtain a blade load is kW per meter (or horsepower per foot) of cutting edge. The higher the kW/meter (HP/foot), the more aggressive the blade. Kilowatt per Lm^3 (horsepower per loose cubic yard) indicates a blade's ability to push material. The higher the kW/ Lm^3 (HP/LCY), the greater the blade's potential capability for carrying material at a greater speed.

Tractor Limitations

The weight and horsepower of the machine determines its ability to push. No tractor can exert more pounds push than the machine itself weighs and its power train can develop. Various terrain and under-foot conditions on the job limit the tractor's ability

to use its weight and horsepower. The "approximate coefficient of traction factors" chart in the Tables Section presents these traction factors for common materials. To use the chart, take the total tractor weight (with attachments) times the factor to arrive at the maximum usable push the dozer can exert.

Production Dozing Tools

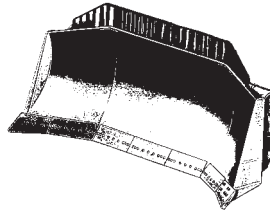

"U" — Universal blade — the large wings on this blade include one end bit and at least one section of cutting edge which make it efficient for moving big loads over long distances as in land reclamation, stockpile

work, charging hoppers and trapping for loaders. As this blade has a lower kW/meter (HP/foot) of cutting edge than an "S" or "SU", penetration should not be a prime objective. With a lower kW/ Lm^3 (HP/LCY) than an "S" or "SU", this blade is best for lighter or relatively easily dozed material. If equipped with tilt cylinder(s), it has some of the versatility of the S-blade. Tilt cylinder(s) improve its ability to ditch, pry out, and level. This extends its use to many utility tasks.

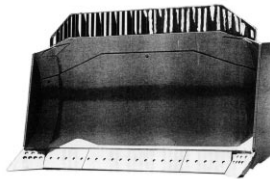

"SU" — The Semi-U blade combines the desirable characteristics of S and U-blades into one package. It has increased capacity by the addition of short wings

which include only the dozer end bits. The wings provide improved load retention capabilities while maintaining the blade's ability to penetrate and load quickly in tightly packed materials and to handle a wide variety of materials in production oriented applications. Tilt cylinder(s) increase both the productivity and versatility of this dozer. Equipped with a push plate, it is effectively used for push load-ing scrapers.

Bulldozers

Blade Selection

- General Purpose Dozing Tools
- Special Attachments “VR Blades”
- Special Application Dozing Tools

General Purpose Dozing Tools

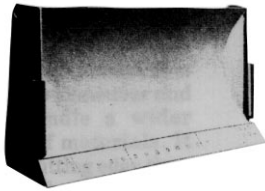

“S” — The Straight blade provides excellent versatility. Since it is physically smaller than the SU or U-blade, it is easier to maneuver and can handle a wider range of materials. It has a higher kW/

meter (HP/foot) of cutting edge than the SU or U-blade; consequently, the “S” is more aggressive in penetrating and obtaining a blade load. A tilt cylinder increases both the productivity and versatility of this dozer. With a high kW/Lm³ (HP/LCY), the S-blade can handle heavy material easily.



Power Angle and Tilt blade — Versatility is its key feature with its ability to perform a variety of site development to general dozing work as well as heavy-

duty applications. Angle and tilt control is with 2 levers on some machines, 1 lever on others.

Variable Power Angle and Tilt (VPAT) blade can be mechanically tipped forward for improved penetration or shedding sticky material and backward for finish grading and improved productivity.

Balderson “VR Blades” (Variable Radius)

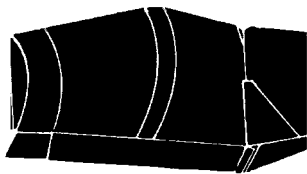

The Balderson Variable Radius Semi-U-Blade combines the benefits of a semi-U-blade such as “cutting” ability and ground penetration with U-blade characteristics

of better load retention and less side spill.

This is achieved with the variable radius moldboard. The variable radius moldboard causes dirt to move to the center of the blade creating more rolling action. The extended side plates retain the load and increase capacities.

The variable radius semi-U-blade is an excellent tool for land improvement, soil conservation, site development, or general construction.

Special Application Dozing Tools

Caterpillar and other blade manufacturers provide specialty bulldozers for specific applications. The blades are designed to increase production while performing certain tasks. However, specialization may reduce the blade versatility. Following are the most popular special applications blades.



“A” — Or Angling blade can be positioned straight or angled 25 degrees to either side. It is designed for side-casting, pioneering roads, backfilling, cutting ditches and other similar tasks. It can reduce the amount of maneuvering required to do these jobs. Its “C” frame can be used for attachments such as pushing, land clearing, or snow removal tools. A-blades are not recommended for rock or severe applications.

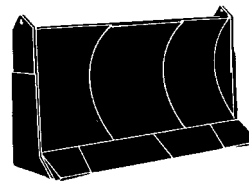

“C” — The Balderson Cushion blade is used for on-the-go push-loading. Rubber cushions allow the dozer to absorb the impact of contacting a scraper push block. When not push-loading, the dozer can be used for cut maintenance and other general dozing jobs. The narrow width of the C-blade increases machine maneuverability in congested cuts and reduces the possibility of cutting tires associated with SU and U-blades.

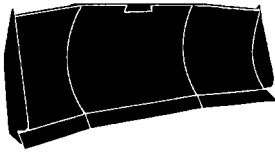

“U-Blades” — Balderson offers a variety of U-blades for use in a wide range of applications. They provide high volume movement of light non-cohesive materials such as coal and woodchips. Heavier U-blades are also offered for production dozing and reclamation work.

“Landfill” — Caterpillar and Balderson offer versions of the landfill or fill spreading dozer. Designed to handle refuse and cover material. Open trash screen on top of blade allows good visibility and protects radiator. Curved moldboard keeps cover material rolling evenly.

“Two-Way Dozer” — Designed for use inside ship holds to move cargo such as grain, salt, iron ore, coal and chips. These blades can scrape material off walls and doze to center of hold. They can doze material forward or pull material.

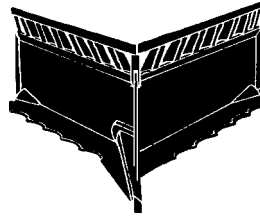

“V-Tree Cutter” — Rimco and Rome offer this clearing blade for shearing trees, stumps and brush at ground level. A sharp angle or “V”, formed by two cutting blades, utilizes tractor weight and horsepower through the centerline of the cutter. Utilization of tractor force allows most growth to be cut at a steady pace and cast to the sides.

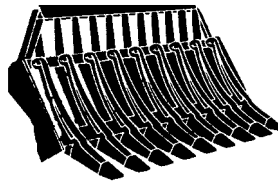

“Rakes” — Balderson, Rimco and Rome offer a variety of rakes for use in land clearing applications. They handle vegetation up to tree size, and offer good soil penetration for removal of small stumps, rocks and roots. In most cases rake tines are replaceable.

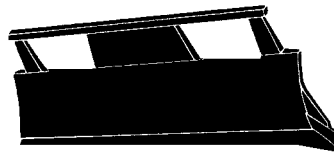

“K/G” — Offered by Rimco and Rome, the K/G-blade is used in many land clearing applications. In addition to cutting trees this versatile blade can pile vegetation, cut v-type drainage ditches and build woods roads and firebreaks. Weldco-Beales offers a blade of similar design called the One-Way Brush Cutter.

Bulldozers

General Dimensions Key

- Tractor and Blade
- SAE Blade Capacity Definition

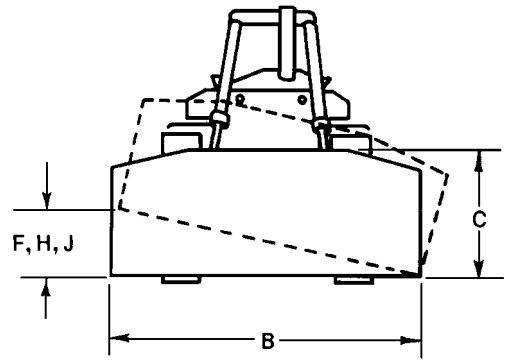
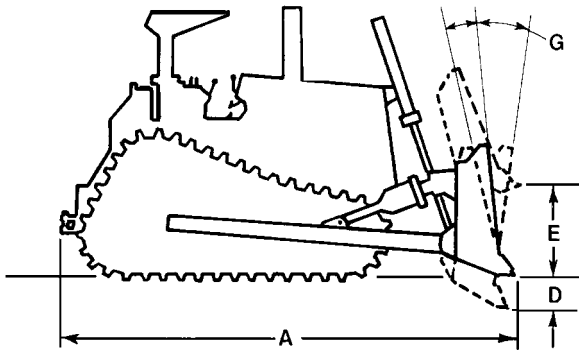

KEY

- A** Length (Blade Straight)
Blade:
- B** Width (including standard end bits)
- C** Height
- D** Maximum Digging Depth
- E** Ground Clearance @ Full Lift
- F** Maximum Tilt (Manual)
- G** Maximum Pitch Adjustment
- H** Maximum Hydraulic Tilt
- J** Hydraulic Tilt (manual brace centered)
- K** Pusharm Trunnion Width (to Ball Centers)

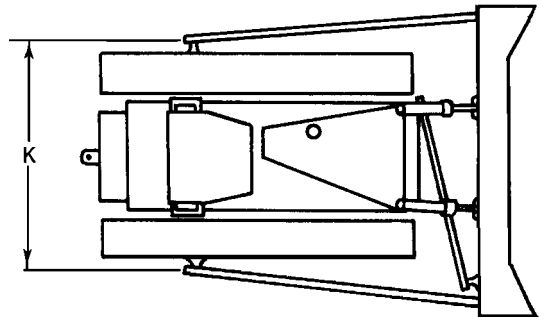

Blade capacities on the following pages are as determined by SAE recommended practice J1265. Capacities are defined as:

$$V_s = 0.8 WH^2.$$

$$V_u = V_s + ZH (W-Z) \tan X.$$

Where: V_s = Capacity of straight or angling blade.

V_u = Capacity of semi-U or full U-blade.

W = Blade width exclusive of end bits.

H = Effective blade height considering tapered top corners, etc.

Z = Wing length measured parallel to blade width @ ground line of cutting edges.

X = Wing angle.

Blade Specifications

- D3C Series III — All Models & Hydrostatics
- D4C Series III — All Models & Hydrostatics
- D5C Series III — All Models & Hydrostatics

MODEL	D3C Series III, D3C LGP Series III & Hydrostatic					
	3P		3P Hystat		3P LGP	
Type	Power Angling and Tilt		Power Angling and Tilt		Power Angling and Tilt	
Blade Capacities*	1.26 m ³	1.64 yd ³	1.26 m ³	1.64 yd ³	1.31 m ³	1.70 yd ³
Weight Shipping** (Dozer)	1126 kg	2482 lb	1126 kg	2482 lb	1213 kg	2674 lb
Tractor & Dozer Dimensions:						
A Length (Blade Straight)	3.86 m	12'8"	3.98 m	13'1"	3.95 m	13'0"
Length (Blade Angled)	4.26 m	14'0"	4.26 m	14'0"	4.63 m	15'2"
Width (Blade Angled)	2.31 m	7'7"	2.31 m	7'7"	2.90 m	9'6"
Width (with C-Frame only)	—		—		—	
Blade Dimensions:	(inside mounted)		(inside mounted)		(inside mounted)	
B Width (including std. end bits)	2.55 m	8'4"	2.55 m	8'4"	3.19 m	10'6"
C Height	836 mm	2'8.9"	836 mm	2'8.9"	746 mm	2'5.4"
D Max. Digging Depth	410 mm	16.2"	418 mm	16.5"	398 mm	15.7"
E Ground Clearance @ Full Lift	773 mm	2'6.4"	761 mm	2'6"	761 mm	2'6"
G Pitch Adjustment	50°–55°		50°–55°		50°–55°	
J Hydraulic Tilt	356 mm	14"	356 mm	14"	490 mm	1'7.3"
Blade Angle	25°		25°		25°	

MODEL	D4C Series III, D4C LGP Series III & Hydrostatic D5C Series III, D5C LGP Series III & Hydrostatic							
	4P		4P LGP		5P		5P LGP	
Type	Power Angling and Tilt		Power Angling and Tilt		Power Angling and Tilt		Power Angling and Tilt	
Blade Capacities*	1.68 m ³	2.18 yd ³	1.70 m ³	2.21 yd ³	1.93 m ³	2.51 yd ³	2.06 m ³	2.70 yd ³
Weight Shipping** (Dozer)	1202 kg	2650 lb	1284 kg	2831 lb	1355 kg	2987 lb	1376 kg	3027 lb
Tractor & Dozer Dimensions:								
A Length (Blade Straight)	3.99 m	13'1"	3.99 m	13'1"	4.07 m	13'4"	4.07 m	13'4"
Length (Blade Angled)	4.42 m	14'6"	4.54 m	14'11"	4.51 m	14'10"	4.631 m	15'2"
Width (Blade Angled)	2.49 m	8'2"	3.03 m	9'11"	2.50 m	8'2"	3.00 m	9'10"
Width (with C-Frame only)	—		—		—		—	
Blade Dimensions:	(inside mounted)		(inside mounted)		(inside mounted)		(inside mounted)	
B Width (including std. end bits)	2.70 m	10'10"	3.34 m	10'11"	2.75 m	9'0"	3.30 m	10'10"
C Height	928 mm	3'0.5"	837 mm	2'9"	999 mm	3'3.3"	929 mm	3'0.6"
D Max. Digging Depth	448 mm	17.6"	443 mm	17.4"	479 mm	18.9"	452 mm	17.8"
E Ground Clearance @ Full Lift	775 mm	2'6.5"	775 mm	2'6.5"	809 mm	2'7.9"	835 mm	2'8.9"
G Pitch Adjustment	50°–55°		50°–55°		50°–55°		50°–55°	
J Hydraulic Tilt	406 mm	16"	495 mm	1'7.5"	412 mm	16.2"	490 mm	1'7.3"
Blade Angle	25°		25°		25°		25°	

*Blade capacities as determined by SAE J1265.
 **Shipping Weight — Total Bulldozer Arrangement includes: Blade, push arms or C-frame, braces, cylinders, lines, trunnions and lift cylinder mountings.

Bulldozers

Blade Specifications

- D5M XL ● D5M LGP
- D6M XL ● D6M LGP

MODEL	D5M XL		D5M LGP		D6M XL			
	5P		5P LGP		6SU		6P	
Type	Power Angling and Tilt		Power Angling and Tilt		Semi-U			
Blade Capacities*	2.59 m ³	3.39 yd³	2.03 m ³	2.66 yd³	4.28 m ³	5.60 yd³	3.18 m ³	4.14 yd³
Weight, Shipping** (Dozer)	1932 kg	4250 lb	2000 kg	4400 lb	2427 kg	5351 lb	2372 kg	5229 lb
Tractor & Dozer Dimensions:								
A Length (Blade Straight)	4.56 m	14'8"	5.13 m	16'10"	4.92 m	16'2"	4.80 m	15'9"
Length (Blade Angled)	5.24 m	16'10"	5.80 m	19'0"	—	—	5.44 m	17'10"
Width (Blade Angled)	2.79 m	9'2"	3.04 m	10'0"	—	—	2.96 m	9'9"
Width (with C-Frame only)	—	—	—	—	—	—	—	—
Blade Dimensions:								
B Width (including std. end bits)	(inside mounted)		(inside mounted)		(outside mounted)		(inside mounted)	
C Height	3.08 m	10'1"	3.36 m	11'0"	3.14 m	10'4"	3.27 m	10'9"
D Max. Digging Depth	1109 mm	3'7.6"	910 mm	2'11.8"	1244 mm	4'1"	1195 mm	3'11"
E Ground Clearance @ Full Lift	441 mm	17.4"	491 mm	1'7.3"	520 mm	1'8.5"	444 mm	17.5"
G Max. Pitch	916 mm	3'0.1"	923 mm	3'0.3"	983 mm	3'2.7"	925 mm	3'0.4"
H Max. Hydraulic Tilt	+2°–6°		+2°–6°		±5°		+2°–6°	
J Hydraulic Tilt	—	—	—	—	665 mm	2'2.2"	—	—
Blade Angle	460 mm	18.1"	491 mm	1'7.3"	372 mm	14.6"	497 mm	1'7.6"
	25°		25°		—		25°	

*Blade capacities as determined by SAE J1265.

**Shipping Weight — Total bulldozer arrangement includes: Blade, push arms or C-frame, braces, cylinders, lines, trunnions and lift cylinder mountings.

MODEL	D6M LGP	
	LGP	
Type	Power Angling and Tilt	
Blade Capacities*	3.16 m ³	4.11 yd³
Weight, Shipping** (Dozer)	2819 kg	6215 lb
Tractor & Dozer Dimensions:		
A Length (Blade Straight)	5.39 m	17'8"
Length (Blade Angled)	6.20 m	20'4"
Width (Blade Angled)	3.70 m	12'2"
Width (with C-Frame only)	—	—
Blade Dimensions:		
B Width (including std. end bits)	(inside mounted)	
C Height	4.08 m	13'5"
D Max. Digging Depth	1025 mm	3'4.4"
E Ground Clearance @ Full Lift	433 mm	17.0"
G Max. Pitch	1024 mm	3'4.3"
H Max. Hydraulic Tilt	+2°–6°	
J Hydraulic Tilt	—	—
Blade Angle	598 mm	1'11.5"
	25°	

*Blade capacities as determined by SAE J1265.

Notice that the capacity of the U-blade is the volume carried by a straight blade of the same dimensions plus the volume included in the "cup" of the U-blade. It is intended for **relative comparisons of dozer sizes**, and not for predicting capacities or productivities in actual field conditions.

**Shipping Weight — Total Bulldozer Arrangement includes: Blade, push arms or C-frame, braces, cylinders, lines, trunnions and lift cylinder mountings.

MODEL	D6R, D6R XL & D6R LGP					
	6A		6A Heavy Duty		6A XL	
Type	Angling		Angling		Angling	
Blade Capacities*	3.18 m ³	4.16 yd ³	3.93 m ³	5.14 yd ³	3.93 m ³	5.14 yd ³
Weight, Shipping** (Dozer)	2727 kg	5999 lb	3218 kg	7079 lb	3109 kg	6839 lb
Tractor & Dozer Dimensions:						
A Length (Blade Straight)	5.22 m	17'1"	5.22 m	17'1"	5.43 m	17'10"
Length (Blade Angled)	6.05 m	19'10"	6.05 m	19'10"	6.26 m	20'6"
Width (Blade Angled)	3.78 m	12'5"	3.78 m	12'5"	3.78 m	12'5"
Width (with C-Frame only)	2.91 m	9'7"	2.91 m	9'7"	2.98 m	9'10"
Blade Dimensions:						
B Width (including std. end bits)	4.16 m	13'8"	4.16 m	13'8"	4.16 m	13'8"
C Height	1033 mm	3'4.7"	1155 mm	3'9.5"	1155 mm	3'9.5"
D Max. Digging Depth	506 mm	1'7.9"	506 mm	1'7.9"	524 mm	1'8.6"
E Ground Clearance @ Full Lift	1141 mm	3'8.9"	1141 mm	3'8.9"	1205 mm	3'11.4"
F Manual Tilt	408 mm	16.1"	408 mm	16.1"	408 mm	16.1"
G Max. Pitch	—		—		—	
H Max. Hydraulic Tilt Blade Angle	408 mm	16.1" ◀	408 mm	16.1" ◀	408 mm	16.1"
J Hydraulic Tilt (Manual Brace Centered)	—		—		—	

MODEL	D6R, D6R XL & D6R LGP					
	6S		6SU		6SU XL	
Type	Straight		Semi Universal		Semi Universal	
Blade Capacities*	3.89 m ³	5.09 yd ³	5.61 m ³	7.34 yd ³	5.61 m ³	7.34 yd ³
Weight, Shipping** (Dozer)	2599 kg	5717 lb	2699 kg	5937 lb	2973 kg	6540 lb
Tractor & Dozer Dimensions:						
A Length (Blade Straight)	5.12 m	16'9"	5.31 m	17'5"	5.55 m	18'2"
Length (Blade Angled)	—		—		—	
Width (Blade Angled)	—		—		—	
Width (with C-Frame only)	—		—		—	
Blade Dimensions:						
B Width (including std. end bits)	3.36 m	11'0"	3.26 m	10'8"	3.26 m	10'8"
C Height	1257 mm	4'1.5"	1411 mm	4'7.6"	1411 mm	4'7.6"
D Max. Digging Depth	473 mm	18.6"	473 mm	18.6"	459 mm	18.1"
E Ground Clearance @ Full Lift	1104 mm	3'7.5"	1104 mm	3'7.5"	1195 mm	3'11.1"
F Manual Tilt	689 mm	2'3.1"	670 mm	2'2.4"	670 mm	2'2.4"
G Max. Pitch	+5.3°–4.8°		+5.3°–4.8°		+5.3°–4.8°	
H Max. Hydraulic Tilt Blade Angle	764 mm	2'6.1"	743 mm	2'5.3"	743 mm	2'5.3"
J Hydraulic Tilt (Manual Brace Centered)	420 mm	16.5"	408 mm	16.1"	408 mm	16.1"

*Blade capacities as determined by SAE J1265.

Notice that the capacity of the U-blade is the volume carried by a straight blade of the same dimensions plus the volume included in the "cup" of the U-blade. It is intended for **relative comparisons of dozer sizes**, and not for predicting capacities or productivities in actual field conditions.

**Shipping Weight — Total Bulldozer Arrangement includes: Blade, push arms or C-frame, braces, cylinders, lines, trunnions and lift cylinder mountings.

◀ Attachment includes two cylinders.

Bulldozers

Blade Specifications

- D6R ● D6R XL ● D6R LGP
- D7R ● D7R LGP

MODEL	D6R, D6R XL & D6R LGP					
	6S LGP		6A (IG)		6SU (IG)	
Type	Straight		Angling		Semi Universal	
Blade Capacities*	3.70 m ³	4.83 yd³	4.3 m ³	5.63 yd³	5.62 m ³	7.4 yd³
Weight, Shipping** (Dozer)	2801 kg	6162 lb	3260 kg	7180 lb	2950 kg	6500 lb
Tractor & Dozer Dimensions:						
A Length (Blade Straight)	5.71 m	18'9"	—		—	
Blade Dimensions:						
B Width (including std. end bits)	3.99 m	13'1"	4.20 m	13'9"	3.56 m	11'8"
C Height	1101 mm	3'7.3"	1169 mm	3'10"	1412 mm	4'8"
D Max. Digging Depth	655 mm	2'1.2"	500 mm	1'7.7"	459 mm	18.1"
E Ground Clearance @ Full Lift	1083 mm	3'6.6"	1242 mm	4'1"	1195 mm	3'11"
F Manual Tilt	632 mm	2'0.9"	408 mm	16.1"	670 mm	2'2.4"
G Max. Pitch	+5.3°–4.8°		+5.3°–4.8°		+5.3°–4.8°	
H Max. Hydraulic Tilt	701 mm	2'3.6"	408 mm	16.1"	743 mm	2'5.3"
J Hydraulic Tilt (Manual Brace Centered)	385 mm	15.2"	408 mm	16.1"	743 mm	2'5.3"

*Blade capacities as determined by SAE J1265.

Notice that the capacity of the U-blade is the volume carried by a straight blade of the same dimensions plus the volume included in the "cup" of the U-blade. It is intended for **relative comparisons of dozer sizes**, and not for predicting capacities or productivities in actual field conditions.

**Shipping Weight — Total Bulldozer Arrangement includes: Blade, push arms or C-frame, braces, cylinders, lines, trunnions and lift cylinder mountings.

MODEL	D7R & D7R LGP									
	7A		7S		7SU		7U		7S LGP	
Type	Angling		Straight		Semi Universal		Universal		Straight	
Blade Capacities*	3.89 m ³	5.08 yd³	5.16 m ³	6.75 yd³	6.86 m ³	8.98 yd³	8.34 m ³	10.91 yd³	5.89 m ³	7.7 yd³
Weight, Shipping** (Dozer)	3527 kg	7750 lb	3500 kg	7716 lb	3593 kg	7904 lb	3920 kg	8624 lb	3732 kg	8210 lb
General Dimensions (Tractor & Dozer)										
A Length (Blade Straight)	6.10 m	20'0"	5.81 m	19'1"	6.03 m	19'9"	6.27 m	20'7"	5.81 m	19'1"
Length (Blade Angled)	6.98 m	22'11"	—		—		—		—	
Width (Blade Angled)	4.12 m	13'6"	—		—		—		—	
Width (with C-Frame only)	3.09 m	10'1"	—		—		—		—	
Blade Dimensions:										
B Width (including std. end bits)	4.50 m	14'9"	3.90 m	12'10"	3.69 m	12'1"	3.98 m	13'1"	4.50 m	14'9"
C Height	1111 mm	3'7.7"	1363 mm	4'5.7"	1524 mm	5'0"	1553 mm	5'1.1"	1343 mm	4'4.9"
D Max. Digging Depth	669 mm	2'2.3"	527 mm	1'8.7"	527 mm	1'8.7"	527 mm	1'8.7"	668 mm	2'2.3"
E Ground Clearance @ Full Lift	1115 mm	3'7.9"	1145 mm	3'9.1"	1145 mm	3'9.1"	1145 mm	3'9.1"	1153 mm	3'9.4"
F Manual Tilt	466 mm	18.3"	—		—		—		—	
G Max. Pitch Adjustment	—		+3.1°–3.9°		+3.1°–3.9°		+3.1°–3.9°		+3.0°–3.9°	
Blade Angle (either side)	25°		—		—		—		—	
H Max. Hydraulic Tilt	627 mm	2'0.7" ◀	845 mm	2'9.3"	799 mm	2'7.4"	861 mm	2'9.9"	686 mm	2'3"
J Hydraulic Tilt (Manual Brace Centered)	—		501 mm	1'7.7"	474 mm	18.6"	511 mm	1'8.1"	426 mm	16.8"

*Blade capacities as determined by SAE J1265.

Notice that the capacity of the U-blade is the volume carried by a straight blade of the same dimensions plus the volume included in the "cup" of the U-blade. It is intended for **relative comparisons of dozer sizes**, and not for predicting capacities or productivities in actual field conditions.

**Shipping Weight — Total Bulldozer Arrangement includes: Blade, push arms or C-frame, braces, cylinders, lines, trunnions and lift cylinder mountings.

◀ Attachment includes two cylinders.

MODEL	D8R						D9R			
	8A		8SU		8U		9SU		9U	
Type	Angling		Semi-U		Universal		Semi-U		Universal	
Blade Capacities*	4.66 m ³	6.09 yd³	8.68 m ³	11.4 yd³	11.70 m ³	15.3 yd³	13.5 m ³	17.7 yd³	16.4 m ³	21.4 yd³
Weight, Shipping** (Dozer)	5459 kg	12,009 lb	4930 kg	10,846 lb	5495 kg	12,089 lb	6543 kg	14,425 lb	7134 kg	15,727 lb
General Dimensions (Tractor & Dozer)										
A Length (Blade Straight)	6.57 m	21'7"	6.39 m	21'0"	6.79 m	22'3"	6.84 m	22'5"	7.18 m	23'7"
Length (Blade Angled)	7.62 m	25'0"	—	—	—	—	—	—	—	—
Width (Blade Angled)	4.52 m	14'10"	—	—	—	—	—	—	—	—
Width (with C-Frame only)	3.38 m	11'1"	—	—	—	—	—	—	—	—
Blade Dimensions:										
B Width (including std. end bits)	4.99 m	16'4"	3.94 m	12'11"	4.26 m	14'0"	4.31 m	14'2"	4.65 m	15'3"
C Height	1174 mm	3'10.2"	1690 mm	5'6.5"	1740 mm	5'8.5"	1934 mm	6'4.1"	1934 mm	6'4.1"
D Max. Digging Depth	628 mm	2'0.7"	582 mm	1'10.9"	582 mm	1'10.9"	606 mm	1'11.9"	606 mm	1'11.9"
E Ground Clearance @ Full Lift	1308 mm	4'3.5"	1231 mm	4'0.5"	1231 mm	4'0.5"	1422 mm	4'8"	1422 mm	4'8"
G Max. Pitch Adjustment Blade Angle (either side)	—	25°	+3.0°–2.9°	—	+3.0°–2.9°	—	+3.4°–2.9°	—	+3.4°–2.9°	—
H Max. Hydraulic Tilt	729 mm	2'4.7" ◀	951 mm	3'1.4"	1028 mm	3'4.5"	940 mm	3'1"	1014 mm	3'3.9"
J Hydraulic Tilt (Manual Brace Centered)	—	—	650 mm	2'1.6"	703 mm	2'3.7"	570 mm	1'10.4"	616 mm	2'0.3"
K Pusharm Trunnion Width (to Ball Centers)	2.98 m	9'9"	2.98 m	9'9"	2.98 m	9'9"	3.17 m	10'3"	3.17 m	10'3"
Maximum Track Width Permitted	712 mm	2'4"	711 mm	2'4"	711 mm	2'4"	762 mm	2'6"	762 mm	2'6"
Dual Tilt Option										
G Dual Pitch Adj.	—	—	—	—	—	—	+4.8°–5.2°	—	+4.8°–4.9°	—
H Dual Max. Hyd. Tilt	—	—	—	—	—	—	1139 mm	3'8.8"	1231 mm	4'0.5"

*Blade capacities as determined by SAE J1265.

Notice that the capacity of the U-blade is the volume carried by a straight blade of the same dimensions plus the volume included in the "cup" of the U-blade. It is intended for **relative comparisons of dozer sizes**, and not for predicting capacities or productivities in actual field conditions.

**Shipping Weight — Total Bulldozer Arrangement includes: Blade, push arms or C-frame, braces, cylinders, lines, trunnions and lift cylinder mountings.

◀ Attachment includes two cylinders.

MODEL	D10R				D11R					
	10SU		10U		11SU		11U		11 C.D.	
Type	Semi-U		Universal		Semi-U		Universal		Universal	
Blade Capacities*	18.5 m ³	24.2 yd³	22.0 m ³	28.7 yd³	27.2 m ³	35.5 yd³	34.4 m ³	45.0 yd³	43.6 m ³	57.0 yd³
Weight, Shipping**										
Standard Dozer	10 229	22,550	10 784	23,775	14 813	32,658	17 296	38,131	21 678	47,800
	kg	lb	kg	lb	kg	lb	kg	lb	kg	lb
Abrasion Dozer	11 069	24,403	12 413	27,366	16 192	35,698	18 823	41,498	—	
	kg	lb	kg	lb	kg	lb	kg	lb		
General Dimensions (Tractor & Dozer)										
A Length	7.76 m	25'5"	8.01 m	26'3"	8.38 m	27'6"	8.83 m	28'11"	8.34 m	26'8"
Width	4.86 m	15'11"	5.26 m	17'3"	5.60 m	18'4"	6.35 m	20'10"	6.71 m	22'0"
Blade Dimensions:										
B Width (including std. end bits)	4.86 m	15'11"	5.26 m	17'3"	5.60 m	18'4"	6.35 m	20'10"	6.71 m	22'0"
C Height	2.12 m	6'11"	2.12 m	6'11"	2.37 m	7'9"	2.37 m	7'9"	3.26 m	10'8"
D Max. Digging Depth	674 mm	2'2.5"	674 mm	2'2.5"	766 mm	2'6.2"	766 mm	2'6.2"	766 mm	2'6.2"
E Ground Clearance @ Full Lift	1497 mm	4'10.9"	1497 mm	4'10.9"	1533 mm	5'0.4"	1533 mm	5'0.4"	1533 mm	5'0.4"
G Max. Pitch Adjustment	+1.7°–2.3°		+1.7°–2.3°		+2.1°–2.2°		+2.1°–2.2°		—	
H Max. Hydraulic Tilt	993 mm	3'3.1"	1074 mm	3'6.3"	1184 mm	3'10.6"	1344 mm	4'4.9"	1344 mm	4'4.9"
J Hydraulic Tilt (Manual Brace Centered)	722 mm	2'4.4"	782 mm	2'6.8"	886 mm	2'10.9"	1006 mm	3'3.6"	—	
K Pusharm Trunnion Width (to Ball Centers)	3.60 m	11'10"	3.60 m	11'10"	4.18 m	13'9"	4.18 m	13'9"	4.18 m	13'9"
Maximum Track Width Permitted	762 mm	2'6"	762 mm	2'6"	914 mm	3'0"	914 mm	3'0"	914 mm	3'0"
Dual Tilt Option					+7.5°–7.6° or		+7.5°–7.6° or		—	
G Dual Pitch Adj.	+5.2°–5.5°		+5.2°–5.5°		+0°–13°		+0°–13°		—	
H Dual Max. Hyd. Tilt	1441 mm	4'8.7"	1560 mm	5'1.4"	1706 mm	5'7.2"	1938 mm	6'4.3"	—	

*Blade capacities as determined by SAE J1265.

Notice that the capacity of the U-blade is the volume carried by a straight blade of the same dimensions plus the volume included in the "cup" of the U-blade. It is intended for **relative comparisons of dozer sizes**, and not for predicting capacities or productivities in actual field conditions.

**Shipping Weight — Total Bulldozer Arrangement includes: Blade, push arms or C-frame, braces, cylinders, lines, trunnions and lift cylinder mountings.

MODEL	D4E SR		D5E	
	4A		5A	
Type	Angling		Angling	
Blade Capacities	1.28 m ³	1.65 yd³	1.95 m ³	2.55 yd³
Weight, Shipping* (Dozer)	1395 kg	3075 lb	1543 kg	3402 lb
General Dimensions (Tractor & Dozer)				
A Length (Blade Straight)	3.87 m	12'9"	4.60 m	15'1"
Length (Blade Angled)	4.50 m	14'9"	5.26 m	17'3"
Width (Blade Angled)	2.84 m	9'4"	2.95 m	9'8"
Width (with C-frame only)	2.39 m	7'10"	2.36 m	7'9"
Blade Dimensions:				
B Width (including std. end bits)	3.12 m	10'3"	3.41 m	11'2"
C Height	706 mm	2'3.8"	859 mm	2'9.8"
D Max. Digging Depth	371 mm	14.6"	457 mm	18"
E Ground Clearance @ Full Lift	811 mm	2'7.9"	937 mm	3'0.9"
F Manual Tilt	475 mm	18.7"	338 mm	13.3"
G Max. Pitch Adjustment Blade Angle (either side)	—	25°	—	25°
H Max. Hydraulic Tilt	330 mm	13"	—	—
J Hydraulic Tilt (Manual Brace Centered)	—	—	—	—

MODEL	D6G					
	6A		6S		6SU▶	
Type	Angling		Straight		Semi-U	
Blade Capacities	2.40 m ³	3.14 yd³	3.07 m ³	4.02 yd³	3.80 m ³	4.96 yd³
Weight, Shipping* (Dozer)	2325 kg	5126 lb	1998 kg	4405 lb	2460 kg	5423 lb
General Dimensions (Tractor & Dozer)						
A Length (Blade Straight)	5.15 m	16'11"	5.07 m	16'8"	5.13 m	16'10"
Length (Blade Angled)	5.91 m	19'5"	—	—	—	—
Width (Blade Angled)	3.52 m	11'6"	—	—	—	—
Width (with C-frame only)	2.85 m	9'4"	—	—	—	—
Blade Dimensions:						
B Width (including std. end bits)	3.88 m	12'9"	3.23 m	10'7"	3.20 m	10'6"
C Height	924 mm	3'0.4"	1126 mm	3'8.3"	1235 mm	4'0.6"
D Max. Digging Depth	605 mm	1'11.8"	474 mm	18.7"	472 mm	18.6"
E Ground Clearance @ Full Lift	945 mm	3'1.2"	907 mm	2'11.7"	915 mm	3'0"
F Manual Tilt	367 mm	14.4"	679 mm	2'2.7"	680 mm	2'2.8"
G Max. Pitch Adjustment Blade Angle (either side)	—	25°	—	—	—	—
H Max. Hydraulic Tilt	—	—	810 mm	2'8"	810 mm	2'7.9"
J Hydraulic Tilt (Manual Brace Centered)	—	—	467 mm	18.4"	465 mm	18.3"

*Shipping Weight — Total Bulldozer Arrangement includes: Blade, push arms or C-frame, braces, cylinders, lines, trunnions and lift cylinder mountings.
 Notice that the capacity of the SU-blade is the volume carried by a straight blade of the same dimensions plus the volume included in the "cup" of the SU-blade. It is intended for **relative comparisons of dozer sizes**, and not for predicting capacities or productivities in actual field conditions.
 ▶ Caterpillar Custom Product.

MODEL	D7G			
	7A		7S	
Type	Angling		Straight	
Blade Capacities*	2.9 m ³	3.8 yd³	4.2 m ³	5.5 yd³
Weight, Shipping** (Dozer)	3227 kg	7115 lb	3475 kg	7660 lb
General Dimensions (Tractor & Dozer)				
A Length (Blade Straight)	5.49 m	18'0"	5.30 m	17'5"
Length (Blade Angled)	6.35 m	20'10"	—	—
Width (Blade Angled)	3.86 m	12'8"	—	—
Width (with C-Frame only)	3.12 m	10'3"	—	—
Blade Dimensions:				
B Width (including std. end bits)	4.26 m	14'0"	3.65 m	12'0"
C Height	960 mm	3'1.8"	1274 mm	4'2.1"
D Max. Digging Depth	468 mm	18.4"	438 mm	17.2"
E Ground Clearance @ Full Lift	1206 mm	3'11.5"	1188 mm	3'10.8"
F Manual Tilt	—	—	—	—
G Max. Pitch Adjustment Blade Angle (either side)	—	25°	+5.2°–3.0°	—
H Max. Hydraulic Tilt	300 mm	11.8"◀	721 mm	2'4.4"
J Hydraulic Tilt (Manual Brace Centered)	—	—	505 mm	1'7.9"

*Blade capacities as determined by SAE J1265.

**Shipping Weight — Total Bulldozer Arrangement includes: Blade, push arms or C-frame, braces, cylinders, lines, trunnions and lift cylinder mountings.

◀Attachment includes two cylinders.

BULLDOZER PRODUCTION OFF-THE-JOB

You can estimate bulldozer production using the production curves that follow and the correction factors that are applicable. Use this formula:

$$\text{Production (Lm}^3\text{/hr)} = \frac{\text{Maximum production}}{\text{(LCY/hr)}} \times \frac{\text{Correction factors}}$$

The bulldozer production curves give maximum uncorrected production for universal, semi-universal, and straight blades and are based on the following conditions:

1. 100% efficiency (60 minute hour — level cycle).
2. Power shift machines with 0.05 min. fixed times.
3. Machine cuts for 15 m (50 feet), then drifts blade load to dump over a high wall. (Dump time — 0 sec.)
4. Soil density of 1370 kg/Lm³ (2300 lb/LCY).
5. Coefficient of traction:
 - a. Track machines — 0.5 or better
 - b. Wheel machines — 0.4 or better
6. Hydraulic controlled blades used.
7. Dig 1F**
Carry 2F**
Return 2R**

To obtain estimated production in bank cubic meters or bank cubic yards, appropriate load factor from the Tables section should be applied to the corrected production as calculated above.

$$\text{Production Bm}^3\text{/hr} = \frac{\text{Lm}^3\text{/hr} \times \text{LF}}{\text{(BCY/h)}} = \frac{\text{LCY/h} \times \text{LF}}{\text{(LCY/h)}} \times \text{LF}$$

*Coefficient of traction assumed to be at least 0.4. While poor traction affects both track and wheel vehicles, causing them to take smaller blade loads, wheeled units are affected more severely and production falls much more rapidly. While no fixed rules can predict this production loss, a rough rule of thumb is that wheel dozer production falls off 4% for each one-hundredth decrease in coefficient of traction below 0.40. If, for example, coefficient of traction is 0.30, the difference is ten-hundredths (0.10), and production is 60% (10 × 4% = 40% decrease).

**This gear sequence is based on level to downhill terrain, light to medium density material, and no blade extensions such as spill plates, rock guards, etc. Exceeding these conditions may require carry in 1F, but productivity should equal or exceed “standard conditions” due to the larger loads that can be carried in 1F.

ESTIMATED DOZING PRODUCTION ● Universal Blades ● D7G through D11R

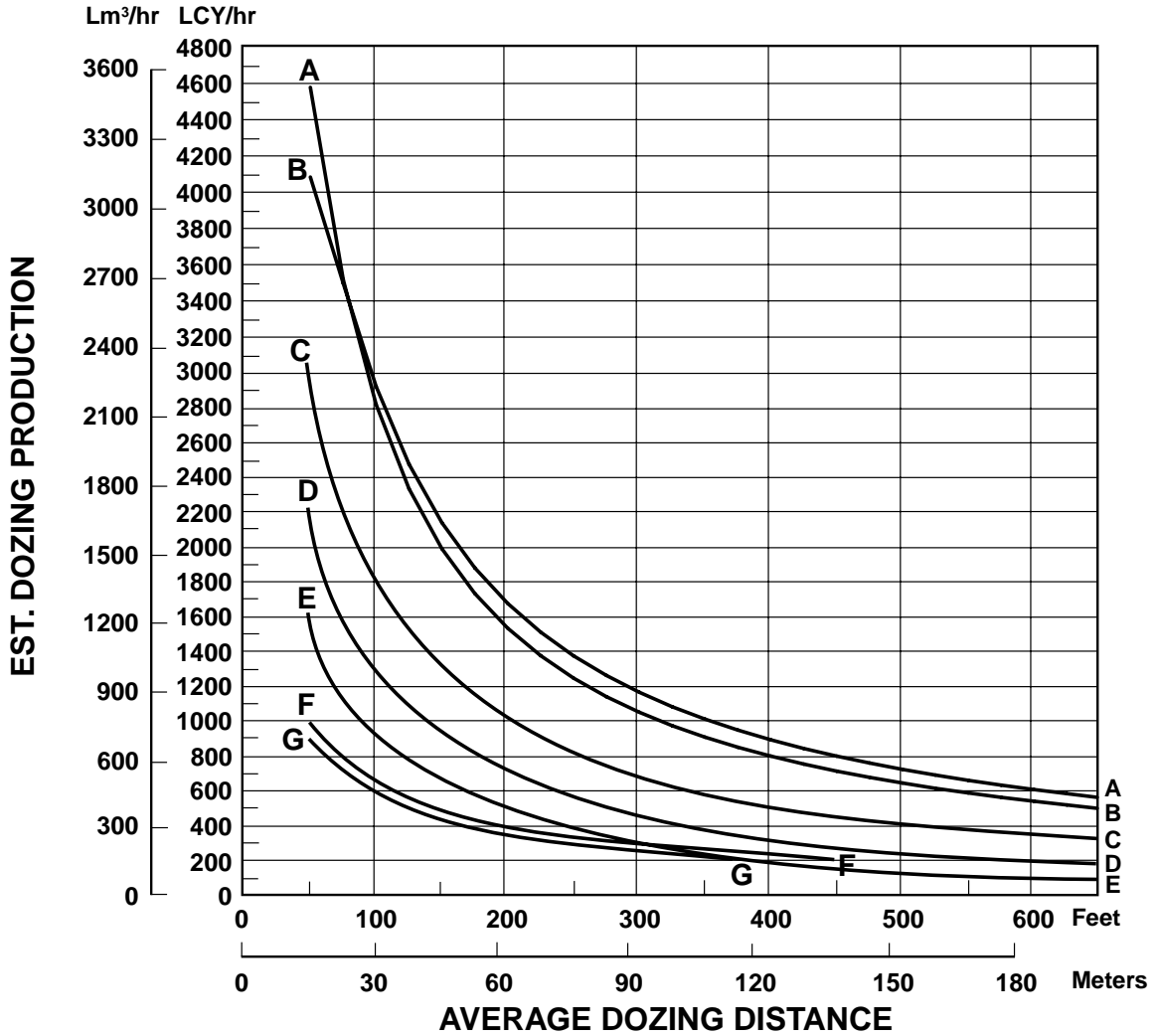

KEY

- A — D11R-11U
- B — D11R C.D.
- C — D10R-10U
- D — D9R-9U
- E — D8R-8U
- F — D7R-7U
- G — D7G-7U

NOTE: This chart is based on numerous field studies made under varying job conditions. Refer to correction factors following these charts.

ESTIMATED DOZING PRODUCTION ● Semi-Universal Blades ● D6M through D11R

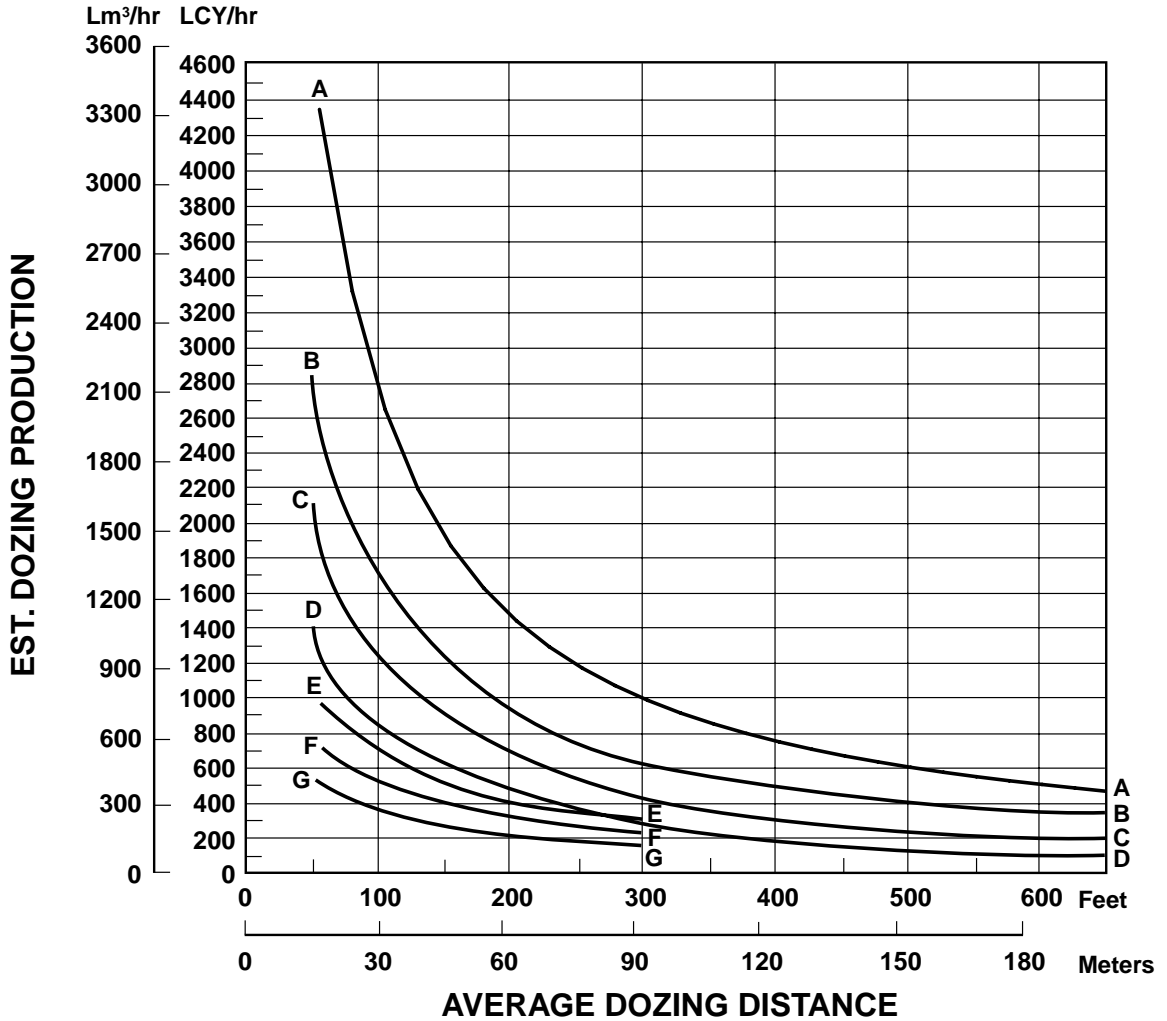

KEY

- A — D11R-11SU
- B — D10R-10SU
- C — D9R-9SU
- D — D8R-8SU
- E — D7R-7SU
- F — D6R-6SU
- G — D6M-6SU

NOTE: This chart is based on numerous field studies made under varying job conditions. Refer to correction factors following these charts.

ESTIMATED DOZING PRODUCTION
Straight Blades ● D3, D6, D7, 814, 824, 834

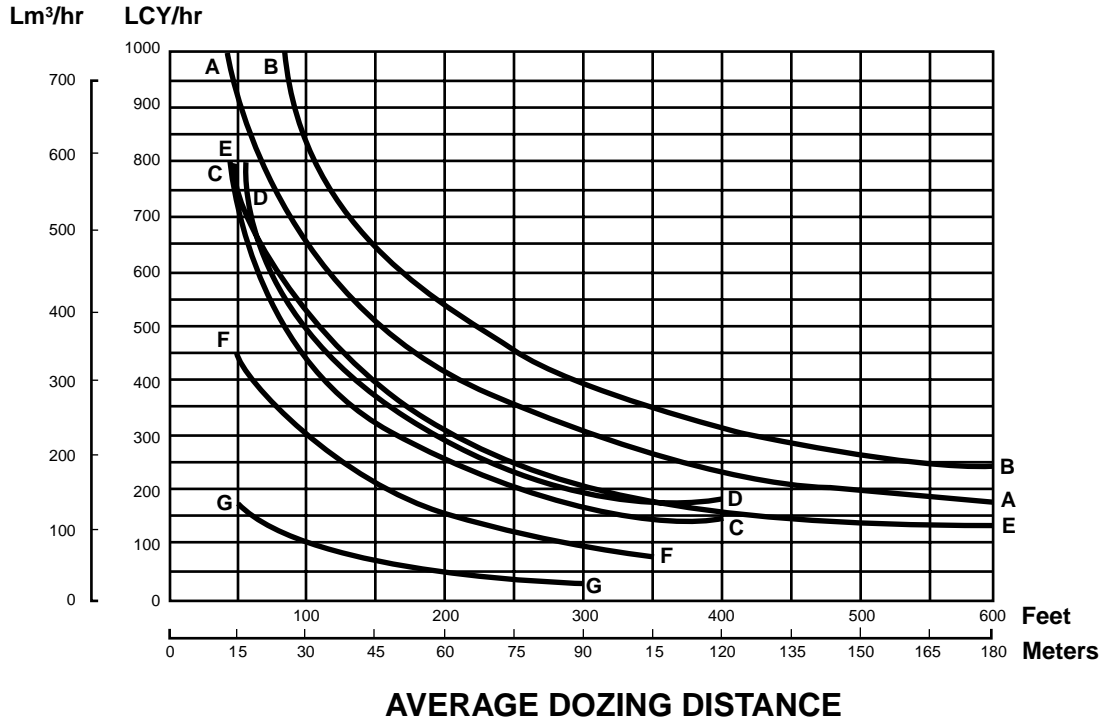

NOTE: This chart is based on numerous field studies made under varying job conditions. Refer to correction factors on the next page.
 *The 3S represented is for the D3C LGP Series II.

Estimated production of the 834B with U-blade can be found in the Coal Handling section of this handbook.

KEY

- A — 824-S
- B — 834-S
- C — D7G-7S
- D — D7R-7S
- E — 814-S
- F — D6R-6S
- G — D3C LGP

JOB CONDITION CORRECTION FACTORS

	TRACK- TYPE TRACTOR	WHEEL- TYPE TRACTOR
OPERATOR —		
Excellent	1.00	1.00
Average	0.75	0.60
Poor	0.60	0.50
MATERIAL —		
Loose stockpile	1.20	1.20
Hard to cut; frozen —		
with tilt cylinder	0.80	0.75
without tilt cylinder	0.70	—
cable controlled blade	0.60	—
Hard to drift; "dead" (dry, non-cohesive material) or very sticky material	0.80	0.80
Rock, ripped or blasted	0.60-0.80	—
SLOT DOZING	1.20	1.20
SIDE BY SIDE DOZING	1.15-1.25	1.15-1.25
VISIBILITY —		
Dust, rain, snow, fog or darkness	0.80	0.70
JOB EFFICIENCY —		
50 min/hr	0.83	0.83
40 min/hr	0.67	0.67
BULLDOZER*		
Adjust based on SAE capacity relative to the base blade used in the Estimated Dozing Production graphs.		
GRADES — See following graph.		

*NOTE: Angling blades and cushion blades are not considered production dozing tools. Depending on job conditions, the A-blade and C-blade will average 50-75% of straight blade production.

% Grade vs. Dozing Factor

(-) Downhill
 (+) Uphill

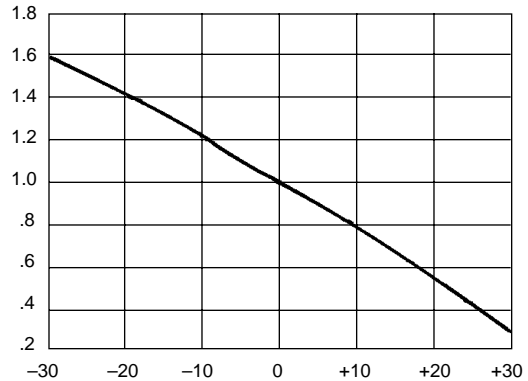

ESTIMATING DOZER PRODUCTION OFF-THE-JOB

Example problem:

Determine average hourly production of a D8R/8SU (with tilt cylinder) moving hard-packed clay an average distance of 45 m (150 feet) down a 15% grade, using a slot dozing technique.

Estimated material weight is 1600 kg/Lm³ (2650 lb/LCY). Operator is average. Job efficiency is estimated at 50 min/hr.

Uncorrected Maximum Production — 458 Lm³/h (600 LCY/hr) (example only)

Applicable Correction Factors:

- Hard-packed clay is "hard to cut" material -0.80
- Grade correction (from graph) -1.30
- Slot dozing -1.20
- Average operator -0.75
- Job efficiency (50 min/hr) -0.83
- Weight correction (2300/2650) -0.87

$$\begin{aligned}
 \text{Production} &= \text{Maximum Production} \times \text{Correction Factors} \\
 &= (600 \text{ LCY/hr}) (0.80) (1.30) (1.20) \\
 &\quad (0.75) (0.83) (0.87) \\
 &= 405.5 \text{ LCY/hr}
 \end{aligned}$$

To obtain production in metric units, the same procedure is used substituting maximum uncorrected production in Lm³.

$$\begin{aligned}
 &= 458 \text{ Lm}^3/\text{h} \times \text{Factors} \\
 &= 309.6 \text{ Lm}^3/\text{h}
 \end{aligned}$$

MEASURING PRODUCTION ON-THE-JOB

Three generally accepted methods of measuring bulldozer production are listed below. The third method is empirical, but is the simplest to conduct.

1. Employing Surveying Techniques
 - a. Conduct time study and then cross-section the cut to determine the volume of material removed. (Production in Bm^3 or BCY per unit of time)
 - b. Conduct time study and then cross-section the fill to determine the volume of fill material. (Production in Lm^3 or LCY per unit of time)
2. Weighing Blade Loads
Conduct time study and weigh material moved by bulldozer by weighing the loader bucket loads.
3. Measuring Blade Loads
 - a. Dozer operation
 - (1) Pick up and carry load onto a level area and stop.
 - (2) Raise the blade directly over the pile pulling forward slightly as blade comes up, leaving a nearly symmetrical pile.
 - (3) Reverse to clear the pile.
 - b. Measurements
 - (1) The average *height* (H) of the pile in feet. Hold the tape vertically at the inside edge of each grouser mark. Sight along top of the pile to obtain the correct measurement.

TOP VIEW

SIDE VIEW

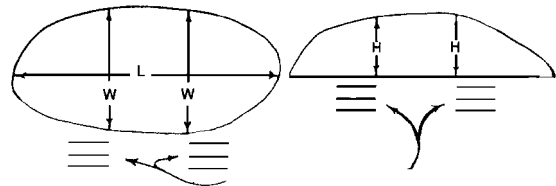

GROUSER MARKS

- (2) The average *width* (W) of the pile in feet. Hold the tape horizontally over the pile and sight at the inside edge of each grouser mark and the corresponding opposite side of the pile.
- (3) The greatest *length* (L) of the pile in feet. Hold the tape horizontally over the pile and sight at each end of the pile.
- c. With the above measurements, now compute the blade load.
 - (1) Average the height measurement (H)
 - (2) Average the width measurement (W)
 - (3) Load (Lm^3 or LCY) = $0.0138 \times (HWL)$
 - (4) Load (Bm^3 or BCY) = Lm^3 or $LCY \times LF$
- d. Combine the calculated blade load with time study to figure production.

SPECIAL ATTACHMENTS

**BALDERSON
VARIABLE RADIUS (VR)
SEMI-U BLADES**

	D6R		D7R		D8R	
Capacity	5.81 m ³	7.6 yd³	7.84 m ³	10.25 yd³	11.28 m ³	14.75 yd³
Width	3349 mm	11'0"	3861 mm	12'8"	4521 mm	14'10"
Height	1473 mm	4'10"	1626 mm	5'4"	1778 mm	5'10"
Weight	1360 kg	3000 lb	1860 kg	4100 lb	2995 kg	6600 lb

**BALDERSON
LANDFILL BLADES**

	D6R		D7R		D8R		D9R	
Capacity	12.5 m ³	16.4 yd³	18.1 m ³	23.7 yd³	24.4 m ³	32 yd³	38.5 m ³	50.3 yd³
Width	3886 mm	12'9"	4267 mm	14'0"	4928 mm	16'2"	5442 mm	17'10"
Height	1796 mm	5'10.7"	2184 mm	7'2"	2286 mm	7'6"	2178 mm	7'1.75"
Weight	1450 kg	3200 lb	2567 kg	5660 lb	3310 kg	7300 lb	4900 kg	10,800 lb

This list is not all inclusive. Contact Balderson for special attachment needs.

- Balderson Cushion Dozers
- Balderson Coal U-Blades
- Balderson Slope Boards
- Balderson Woodchip Dozers
- Balderson Reclamation U-Blades

Bulldozers

1

BALDERSON COAL U-BLADES

	D6R		D7R		D8R		D9R	
Capacity	9.7 m ³	12.63 yd³	16.1 m ³	21.0 yd³	21.4 m ³	28 yd³	35.8 m ³	46.8 yd³
Width	4267 mm	14'0"	4953 mm	16'3"	5537 mm	18'2"	5940 mm	18'10"
Height	1473 mm	4'10"	1829 mm	6'0"	1980 mm	6'6"	2540 mm	8'4"
Weight	1495 kg	3300 lb	2405 kg	5300 lb	3200 kg	7050 lb	5080 kg	11,200 lb

BALDERSON COAL U-BLADES

	D10R		D11R	
Capacity	45.9 m ³	60 yd³	74.9 m ³	98.0 yd³
Width	6191 mm	20'1"	7416 mm	24'4"
Height	2794 mm	9'2"	3530 mm	11'7"
Weight	6330 kg	14,400 lb	11 340 kg	25,000 lb

BALDERSON WOODCHIP DOZERS

	D6M		D6R		D7R		D8R		D9R		D10R	
Capacity	11.5 m ³	15 yd³	15.3 m ³	20 yd³	20.3 m ³	26.6 yd³	28.3 m ³	37 yd³	45.9 m ³	60.0 yd³	72.6 m ³	95 yd³
Width	3657 mm	12'0"	4267 mm	14'0"	4826 mm	15'10"	5486 mm	18'0"	5486 mm	18'0"	6401 mm	21'0"
Height	1829 mm	6'0"	1880 mm	6'2"	2083 mm	6'10"	2337 mm	7'8"	3086 mm	10'1.5"	3480 mm	11'5"
Weight	1542 kg	3400 lb	1905 kg	4200 lb	2765 kg	6100 lb	2925 kg	6450 lb	4900 kg	10,800 lb	8165 kg	18,000 lb

BALDERSON RECLAMATION U-BLADES

	D8R		D9R		D10R		D11R	
Capacity	16.4 m ³	21.5 yd³			30.6 m ³	40 yd³	45.9 m ³	60.0 yd³
Width	4877 mm	16'0"		*	5791 mm	19'0"	7010 mm	23'0"
Height	1880 mm	6'2"			2413 mm	7'11"	2590 mm	8'6"
Weight	3810 kg	8400 lb			6575 kg	14,500 lb	9525 kg	21,000 lb

BALDERSON CUSHION DOZERS

	D8R		D9R		D10R		D11R	
Width	2889 mm	9'5.75"	3048 mm	10'0"	3499 mm	11'5.75"		
Height	1499 mm	4'11"	1575 mm	5'2"	1753 mm	5'9"		*
Weight	3185 kg	7020 lb	4275 kg	9420 lb	6115 kg	13,480 lb		
Balderson Rear Cushion Push Block		*	2175 kg	4800 lb	3105 kg	6850 lb		*

*Available upon request.

This list is not all inclusive. Contact Caterpillar Attachment Products and Services.

RIPPERS

CONTENTS

Features	1-57
Ripper Specification Diagrams	
Adjustable Parallelogram Ripper	1-58
Radial Ripper	1-60
Fixed Parallelogram Ripper	1-60
Specifications	
Track-Type Tractors	1-61
Tip selection	1-67
Estimating ripping production	1-68
Seismic wave velocity charts	1-69
Estimating ripper production graphs	1-75

Features:

- **Parallelogram linkage with hydraulically variable pitch** on D8R, D9R, D10R and D11R. Operator can adjust angle of ripper tip to the material for penetration at all ripping depths to increase production.
- **Fixed Parallelogram linkage design** used on D5E, D6M, D6G, D6R, D7G, D6R XR, D6R XL, D7R and D7R XR. This design holds tooth angle constant at all ripping depths.
- **Fixed Radial rippers** are Multishank with wide beam coverage for utility ripping close to walls, footings and embankments. Ripper tooth angle changes as ripper is raised or lowered. Five shanks available on the D3C Series III, D4C Series III, D5C Series III. Three shanks available for the D5M.
- **Adjustable Single shank** arrangements available for D8R, D9R, D10R and D11R for tough ripping applications and deep ripping requirements.
- **Hydraulically Variable Pitch Multishank** arrangements available in all ripper models, including D8R, D9R, D10R and D11R allow wide-beam coverage in easier-to-rip materials.

DEFINITION OF FORCES SHOWN IN TABLES THAT FOLLOW

“Pryout,” (Breakout) newtons (and pounds) — the maximum sustained upward force, generated by the lift cylinders measured at the ripper tip. Breakout force is measured with the shank in the top hole, shank vertical and ripper full down. Breakout force may be hydraulically or balance limited.

by the ripper lift cylinders measured at the ripper tip, which is required to raise the back end of the vehicle with the tip on ground and the shank (pinned in the top hole) vertical.

“Penetration force,” kilonewtons (and pounds) — the maximum sustained downward force, generated

Adjustable Parallelogram Ripper

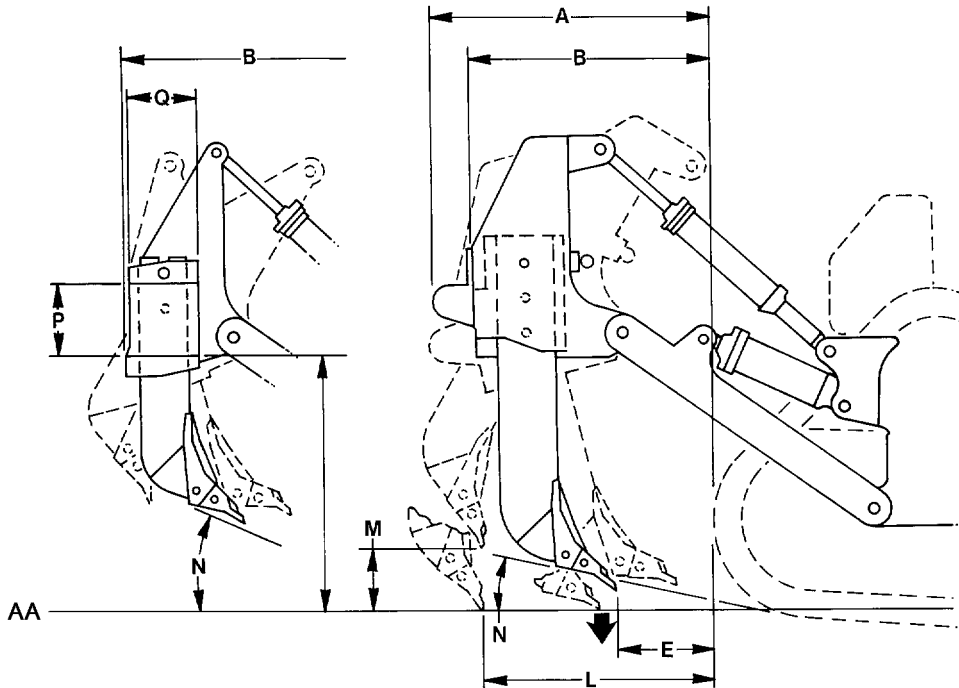

NOTE: Letters correspond to ripper specifications on pages that follow.

KEY
 AA — Ground Line

Adjustable Parallelogram Ripper

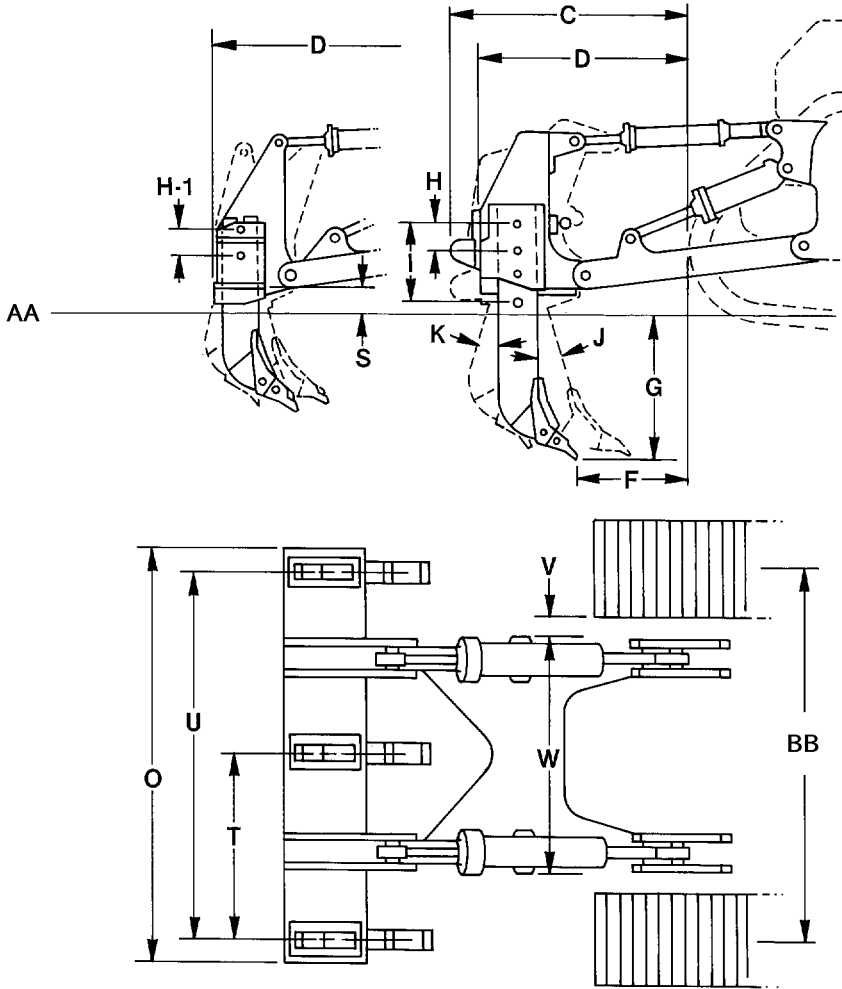

NOTE: Letters correspond to ripper specifications on pages that follow.

KEY

- AA — Ground Line
- BB — Track Gauge

Rippers

Specification Diagrams

- Radial Ripper
- Fixed Parallelogram Ripper

Radial Ripper*

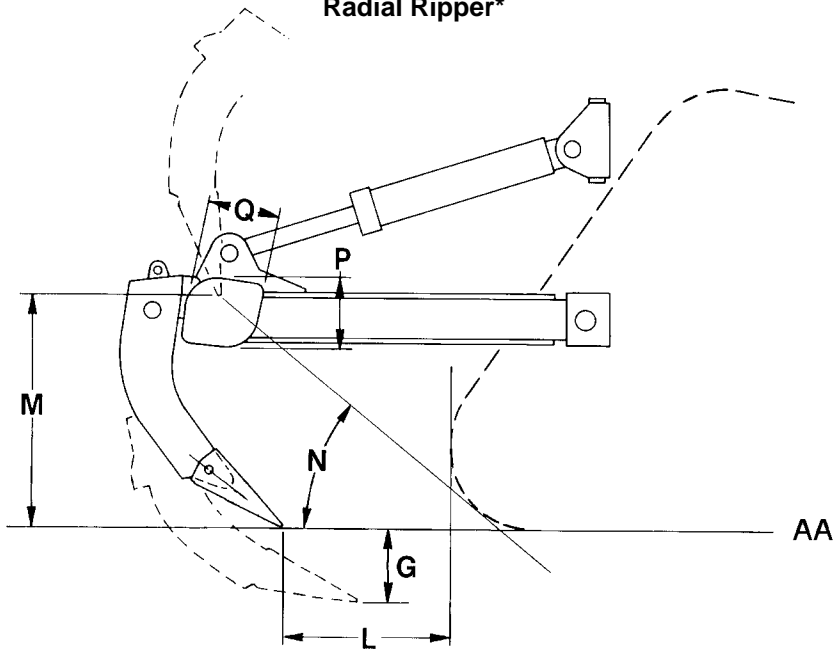

Fixed Parallelogram Ripper

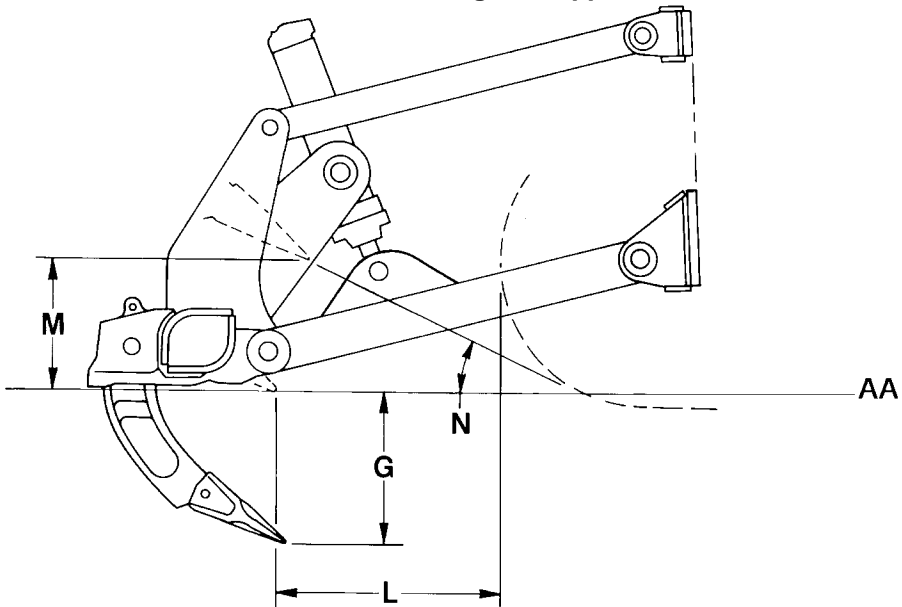

NOTE: Letters correspond to ripper specifications on pages that follow.

KEY

- AA — Ground Line
- * — Tip Standard

TRACTOR/RIPPER	D3C Series III & Hydrostatic		D4C Series III & Hydrostatic		D5C Series III & Hydrostatic		D5M XL**	
Ripper Type	Radial		Radial		Radial		Radial	
Dimensions:								
Ripper Shank								
G Maximum digging depth	284 mm	11.2"	231 mm	9.1"	220 mm	8.7"	350 mm	13.8"
L Maximum reach at ground line	702 mm	2'3.6"	543 mm	1'9.4"	527 mm	1'8.7"	668 mm	2'2.3"
M Maximum ground clearance under tip (shank pinned in bottom hole)	513 mm	1'8.2"	567 mm	1'10.3"	577 mm	1'10.7"	482 mm	1'7"
N Maximum ramp angle, ripper up (shank pinned in bottom hole)	25°		30.5°		31°		25.2°	
Shank section	36 × 76 mm (1.4" × 3")				36 × 76 mm (1.4" × 3")		58 × 139 mm (2.3" × 5.5")	
Ripper Beam								
O Overall width	1.58 m	5'2"	1.58 m	5'2"	1.58 m	5'2"	1.95 m	6'5"
P Height	130 mm	5.1"	130 mm	5.1"	130 mm	5.1"	165 mm	6.5"
Q Length	140 mm	5.5"	140 mm	5.5"	140 mm	5.5"	211 mm	8.3"
Number of Pockets	5		5		5		3	
T Pocket Spacing	356 mm	14"	356 mm	14"	356 mm	14"	896 mm	2'11.3"
U Shank Gauge	1.42 m	4'8"	1.42 m	4'8"	1.42 m	4'8"	1.79 m	5'10"
V Track clearance with standard shoe	151 mm	5.9"	151 mm	5.9"	151 mm	5.9"	108 mm	4.3"
Installed weights:								
Ripper with standard shank	250 kg	550 lb	250 kg	550 lb	250 kg	550 lb	758 kg	1671 lb
Each additional shank	11 kg	24 lb			11 kg	24 lb	34 kg	74 lb
Ripper Forces:*								
Penetration Force	2460 kg	5424 lb	2735 kg	6031 lb	3025 kg	6670 lb	4010 kg	8840 lb
Pryout Force	5265 kg	11,610 lb	5265 kg	11,610 lb	5265 kg	11,600 lb	19 126 kg	42,165 lb

*This value may vary slightly with various vehicle configurations.

**D5M XL and LGP Penetration and pryout forces are for machines equipped with UPAT-Blade and Power Shift Transmission

NOTE: Letters correspond to ripper dimension drawings.

Rippers

Specifications

- D5M LGP
- D6M XL ● D6M LGP

TRACTOR/RIPPER	D5M LGP		D6M XL		D6M LGP	
Ripper Type	Radial		Parallelogram		Parallelogram	
Dimensions:						
Ripper Shank						
G Maximum digging depth	298 mm	11.7"	474 mm	18.6"	360 mm	14.2"
L Maximum reach at ground line	696 mm	2'3.4"	516 mm	1'8.3"	453 mm	17.8"
M Maximum ground clearance under tip (shank pinned in bottom hole)	536 mm	1'9.1"	392 mm	15.4"	506 mm	17.3"
N Maximum ramp angle, ripper up (shank pinned in bottom hole)	25.9°		34.4°		49.5°	
Shank section	58 × 139 mm (2.3" × 5.5")		73 × 176 mm (2.9" × 6.9")		73 × 176 mm (2.9" × 6.9")	
Ripper Beam						
O Overall width	1.95 m	6'5"	2.20 m	7'3"	2.20 m	7'3"
P Height	165 mm	6.5"	216 mm	8.5"	216 mm	8.5"
Q Length	211 mm	8.3"	254 mm	10"	254 mm	10"
Number of Pockets	3		3		3	
T Pocket Spacing	896 mm	2'11.3"	1000 mm	3'3.4"	1000 mm	3'3.4"
U Shank Gauge	1.79 m	5'10"	2 m	6'7"	2 m	6'7"
V Track clearance with standard shoe	124 mm	4.9"	99 mm	3.9"	104 mm	4.1"
Installed weights:						
Ripper with standard shank	758 kg	1671 lb	1406 kg	3100 lb	1406 kg	3100 lb
Each additional shank	34 kg	74 lb	78 kg	172 lb	78 kg	172 lb
Ripper Forces:*						
Penetration Force	4669 kg	10,293 lb	6023 kg	13,278 lb	7198 kg	15,869 lb
Pryout Force	19 260 kg	42,461 lb	12 600 kg	27,778 lb	12 600 kg	27,778 lb

*This value may vary slightly with various vehicle configurations. D5M LGP equipped with UPAT-blade and Power Shift Transmission.

NOTE: Letters correspond to ripper dimension drawings.

TRACTOR/RIPPER	D6R		D6R XL		D7R	
Ripper Type	Parallelogram		Parallelogram		Parallelogram	
Dimensions:						
Ripper Shank						
G Maximum digging depth	500 mm	1'7.7"	500 mm	1'7.7"	748 mm	2'5.4"
L Maximum reach at ground line	729 mm	2'4.7"	729 mm	2'4.7"	1.07 m	3'6.1"
M Maximum ground clearance under tip (shank pinned in bottom hole)	520 mm	1'8.5"	520 mm	1'8.5"	638 mm	2'1.1"
N Maximum ramp angle, ripper up (shank pinned in bottom hole)	26°		26°		26.6°	
Shank section	74 × 175 mm (2.9" × 6.9")		74 × 175 mm (2.9" × 6.9")		72 × 228 mm (2.8" × 6.9")	
Ripper Beam						
O Overall width	2.20 m	7'3"	2.20 m	7'3"	2.21 m	7'3"
P Height	216 mm	8.5"	216 mm	8.5"	279 mm	11"
Q Length	254 mm	10"	254 mm	10"	343 mm	13.5"
Number of Pockets	3		3		3	
T Pocket Spacing	1000 mm	3'3.4"	1000 mm	3'3.4"	991 mm	3'3"
U Shank Gauge	2 m	6'7"	2 m	6'7"	1.98 m	6'6"
V Track clearance with standard shoe	120 mm	4.7"	120 mm	4.7"	95 mm	3.7"
Installed weights:						
Ripper with standard shank	1456 kg	3203 lb	1456 kg	3203 lb	3277 kg	7225 lb
Each additional shank	70 kg	154 lb	70 kg	154 lb	138 kg	305 lb
Ripper Forces:*						
Penetration Force	6558 kg	14,428 lb	7485 kg	16,505 lb	8664 kg	19,104 lb
Pryout Force	9155 kg	20,140 lb	9155 kg	20,140 lb	18 007 kg	39,705 lb

*Tractor equipped with ripper, OROPS, SU dozer and heavy duty track. Values may vary slightly with various configurations.

NOTE: Letters correspond to ripper dimension drawings.

TRACTOR/RIPPER

D8R

D9R

Ripper Type	Adjustable Parallelogram		Adjustable Parallelogram	
	Single Shank	Multishank	Single Shank	Multishank
Dimensions:				
Ripper to Track				
Ripper length behind track, shank vertical, ripper up				
A With Pushblock	NA	NA	NA	NA
B Without Pushblock	1.58 m 5'2"	1.46 m 4'9"	1.57 m 5'2"	1.33 m 4'4"
Ripper length behind track, shank vertical, ripper down				
C With Pushblock	NA	NA	NA	NA
D Without Pushblock	1.84 m 6'0"	1.71 m 5'7"	1.88 m 6'2"	1.71 m 5'7"
Tip to track distance, shank vertical				
E Ripper Up	694 mm 2'3.3"	640 mm 2'1.2"	689 mm 2'3.2"	510 mm 1'8.1"
F Ripper Down	950 mm 3'1.4"	899 mm 2'11.4"	944 mm 3'1.2"	890 mm 2'11"
Ripper Shank*				
G Maximum digging depth	1130 mm 3'8.5"	780 mm 2'6.7"	1231 mm 4'0.6"	798 mm 2'7.6"
H Dig adjustment per hole	305 mm 12"	250 mm 10"	295 mm 12"	250 mm 10"
I Total dig adjustment	610 mm 2'0"	250 mm 10"	590 mm 1'11.2"	250 mm 10"
Pitch Adjustment, ripper down:				
J Forward	15°	14.9°	10.57°	10°
K Backward	9.9°	10°	15.17°	15.10°
L Maximum reach at ground line	1.32 m 4'3"	1.17 m 3'10"	1.25 m 4'1"	1.16 m 3'10"
M Maximum ground clearance under tooth (shank pinned in bottom hole)	636 mm 2'1"	593 mm 1'11.3"	882 mm 2'10.9"	885 mm 2'10.7"
N Maximum ramp angle, ripper up (shank pinned in bottom hole)	28.2°	28.4°	36.89°	37.5°
Shank Section	75 × 333 mm 2.9" × 13.1"	75 × 333 mm 2.9" × 13.1"	90 × 355 mm 3.5" × 14"	75 × 333 mm 2.9" × 13.1"
Ripper Beam				
O Overall width	NA	2.46 m 8'1"	NA	2.64 m 8'8"
P Height	NA	334 mm 13.1"	NA	380 mm 15"
Q Length	NA	457 mm 18"	NA	457 mm 18"
Clearance under beam, shank vertical				
R Ripper Up	NA	1.55 m 5'1"	NA	1.77 m 5'10"
S Ripper Down	NA	449 mm 17.7"	NA	378 mm 14.9"
Number of Pockets	1	3	1	3
T Pocket Spacing	NA	1092 mm 3'7"	NA	1180 mm 3'10.4"
U Shank Gauge	NA	2.17 m 7'1"	NA	2.35 m 7'8"
V Track Clearance with standard shoe	76 mm 3"	76 mm 3"	71 mm 2.8"	71 mm 2.8"
W Width across widest part of lift cylinders	1.37 m 4'5"	1.37 m 4'5"	1.50 m 4'11"	1.50 m 4'11"
Installed Weights:				
Ripper with standard shank	4085 kg 9005 lb	4213 kg 9287 lb	4854 kg 10,700 lb	4885 kg 10,770 lb
Each additional tooth group	NA	332 kg 730 lb	NA	332 kg 733 lb
Ripper Forces:**				
Penetration Force, shank vertical	127 400 N 28,620 lb	124 200 N 27,920 lb	153 885 N 34,581 lb	147 958 N 33,249 lb
Pryout Force, shank vertical	222 800 N 50,070 lb	227 900 N 51,230 lb	320 511 N 72,025 lb	324 680 N 74,639 lb

*Deep Ripping Shank is available for D8R and D9R single shank rippers. Hydraulic pin puller is standard with deep ripping shank.

D8R Deep Ripping Arrangement maximum digging depth is 1.57 m (5'2"). D9R Deep Ripping Arrangement maximum digging depth is 1.66 m (5'5").

**Forces are for a ripper on a tractor equipped with EROPS, U-Dozer and performance track. Forces will vary slightly with other vehicle configurations.

NOTE: Letters correspond to ripper dimension drawings.

NA — Not Applicable.

TRACTOR/RIPPER	D10R		D11R		D11R C.D.	
	Adjustable Parallelogram		Adjustable Parallelogram		Single Shank	
Ripper Type	Single Shank	Multishank	Single Shank	Multishank	Single Shank	
Dimensions:						
Ripper to Track						
Ripper length behind track, shank vertical, ripper up (A)						
A With Pushblock	2.08 m 6'10"	NA	2.19 m 7'2"	NA	NA	
B Without Pushblock	1.76 m 5'9"	1.56 m 5'1"	1.85 m 6'1"	1.92 m 6'4"	2.04 m 6'8"	
Ripper length behind track, shank vertical, ripper down (A)						
C With Pushblock	2.48 m 8'2"	NA	2.59 m 8'6"	NA	NA	
D Without Pushblock	2.16 m 7'1"	1.96 m 6'5"	2.29 m 7'6"	1.92 m 6'4"	2.48 m 8'2"	
Tip to track distance, shank vertical (A)						
E Ripper Up	730 mm 2'4.7"	651 mm 2'1.6"	622 mm 2'0.5"	651 mm 2'1.6"	622 mm 2'0.5"	
F Ripper Down	1130 mm 3'8.5"	1050 mm 3'5.3"	1041 mm 3'5"	1030 mm 3'4.6"	1041 mm 3'5"	
Ripper Shank*						
G Maximum digging depth	1370 mm 4'5.9"	941 mm 3'1"	1612 mm 5'3.5"	1070 mm 3'6.1"	1612 mm 5'3.5"	
H Dig adjustment per hole	355 mm 14"	250 mm 10"	280 mm 11"	280 mm 11"	280 mm 11"	
I Total dig adjustment	710 mm 2'4"	250 mm 10"	840 mm 2'9.1"	280 mm 11"	840 mm 2'9.1"	
Pitch Adjustment, ripper down:						
J Forward	18°	18°	15°	15°	15°	
K Backward	19.7°	19.7°	18.3°	18.5°	18.3°	
L Maximum reach at ground line	1.50 m 4'11"	1.36 m 4'6"	1.73 m 5'8"	1.57 m 5'2"	1.73 m 5'8"	
M Maximum ground clearance under tooth (shank pinned in bottom hole)						
	1070 mm 3'6.1"	1070 mm 3'6.1"	1115 mm 3'7.9"	1137 mm 3'8.8"	1115 mm 3'7.9"	
N Maximum ramp angle, ripper up (shank pinned in bottom hole)						
	36.9°	37.5°	33.9°	37.1°	33.9°	
Shank Section						
	100 × 400 mm 4" × 15.75"	90 × 355 mm 3.5" × 14"	110 × 450 mm 4.3" × 17.7"	100 × 400 mm 3.9" × 15.7"	110 × 450 mm 4.3" × 17.7"	
Ripper Beam						
O Overall width	NA	2.92 m 9'7"	NA	3.33 m 10'11"	NA	
P Height	NA	460 mm 18.1"	NA	560 mm 1'10"	NA	
Q Length	NA	485 mm 1'7.1"	NA	560 mm 1'10"	NA	
Clearance under beam, shank vertical						
R Ripper Up	NA	2.03 m 6'8"	NA	2.06 m 6'9"	NA	
S Ripper Down	NA	380 mm 15"	NA	282 mm 11.1"	NA	
Number of Pockets						
	1	3	1	3	1	
Pocket Spacing						
T	NA	1320 mm 4'4"	NA	1500 mm 5'9"	NA	
Shank Gauge						
U	NA	2.63 m 8'8"	NA	2.99 m 9'10"	NA	
V Track Clearance with standard shoe						
	97 mm 4"	97 mm 4"	141 mm 5.6"	166 mm 5.6"	141 mm 5.6"	
W Width across widest part of lift cylinders						
	1.75 m 5'9"	1.75 m 5'9"	1.90 m 6'3"	1.90 m 6'3"	1.90 m 6'3"	
Installed Weights:						
Ripper with standard shank						
	7117 kg 15,690 lb	6919 kg 15,253 lb	9643 kg 21,215 lb	9698 kg 21,335 lb	13 584 kg 29,885 lb	
Each additional tooth group						
	NA	524 kg 1155 lb	NA	671 kg 1489 lb	NA	
Ripper Forces:**						
Penetration Force, shank vertical						
	205 000 45,980 lb	205 000 45,980 lb	279 865 62,890 lb	265 265 59,610 lb	318 440 71,560 lb	
Pryout Force, shank vertical						
	429 000 96,360 lb	429 000 96,360 lb	657 845 147,830 lb	643 895 144,695 lb	619 260 139,160 lb	

*Deep Ripping Shank is available for D10R & D11R single shank rippers. Hydraulic pin puller is standard with deep ripping shank. Deep Ripping Arrangement maximum digging depth is 1.86 m (6'3") for D10R and 2.18 m (7'2") for D11R.

**Forces are for a ripper on a tractor equipped with an EROPS, U-Dozer and performance track. Forces will vary slightly with other vehicle configurations.

NA — Not Applicable.

TRACTOR/RIPPER	D4E SR/No. 4		D5E/No. 5		D6G/No. 6		D7G/No. 7	
Ripper Type	Parallelogram		Parallelogram		Parallelogram		Parallelogram	
Dimensions:								
Ripper Shank								
G Maximum digging depth	400 mm	16"	478 mm	17"	530 mm	1'8.9"	737 mm	2'5"
L Maximum reach at ground line	640 mm	2'1"	640 mm	2'1"	551 mm	1'9.7"	994 mm	3'3.1"
M Maximum ground clearance under tip (shank pinned in bottom hole)	297 mm	12"	297 mm	12"	218 mm	8.6"	462 mm	18.2"
N Maximum ramp angle, ripper up (shank pinned in bottom hole)	20°		20°		16°		21°	
Shank Section	61 × 140 mm 2.4" × 5.5"		61 × 140 mm 2.4" × 5.5"		76 × 178 mm 3" × 7"		72 × 228 mm 2.8" × 9"	
Ripper Beam								
O Overall width	1.98 m	6'6"	2.34 m	7'8"	2.34 m	7'8"	2.21 m	7'3"
P Height	140 mm	5.5"	140 mm	5.5"	214 mm	8.4"	279 mm	11"
Q Length	171 mm	7"	171 mm	7"	254 mm	10"	343 mm	13.5"
Number of Pockets	5		5		5		3	
T Pocket Spacing	432 mm	17"	432 mm	17"	536 mm	1'9.1"	991 mm	3'3"
U Shank Gauge	1.74 m	5'8"	1.74 m	5'8"	2.15 m	7'1"	1.98 m	6'6"
V Track clearance with standard shoe	60 mm	2"	60 mm	2"	213 mm	8.4"	185 mm	7.3"
Installed weights:								
Ripper with standard shank	1080 kg	2376 lb	1380 kg	3036 lb	1500 kg	3300 lb	2429 kg	5344 lb
Each additional shank	31 kg	68 lb	64 kg	141 lb	64 kg	141 lb	155 kg	341 lb

NOTE: Letters correspond to ripper dimension drawings.

TIP SELECTION FOR THE D8R, D9R, D10R AND D11R RIPPERS

Three tip configurations (short, intermediate and long) in two styles (centerline and penetration) are available for economical operation in a variety of conditions.

RECOMMENDED TIP USAGE

Short — Use in high impact conditions where breakage problems occur. The shorter the tip, the more it resists breakage.

Intermediate — Most effective in moderate impact conditions where abrasion is not excessive.

Long — Use in loose, abrasive materials where breakage is not a problem. Generally offers the most wear material.

Centerline vs Penetration

The materials being ripped and the tractor doing the ripping will both have an effect on which tip will do the best job. High density material requires a “penetration” tip. High impact material requires a “centerline” tip. The following is a general guide to tip application.

Ripping Condition	Tips to use		
	D8R/ D9R	D10R	D11R
Tandem Tractors	Short	Short	Short
Single Shank & Multi-Shank			
Extreme Duty	Int.	Short	Short
Medium Duty	Long	Int.	Int.
Abrasive Duty	Long	Long	Long

Always use the longest tip that will wear without excessive breakage. Different tips should be tried to determine the most economical.

ESTIMATING RIPPING PRODUCTION

Ripping costs must be compared to other methods of loosening the material — usually drilling and blasting — on a cost per ton or bank cubic yard basis. Thus, an accurate estimation of ripper production is needed to determine unit ripping costs.

There are three general methods of estimating ripping production:

1. The best method is to record the time spent ripping, then remove (using scrapers or loaders and trucks) and weigh the ripped material. The total weight divided by the time spent will give hourly production. If the contractor is paid by volume, then a density must be used and the accuracy is only as good as the density used. For payment by volume removed, method 2 may be desirable. Some care will be needed to assure that only ripped material is removed.
2. Another method is to cross-section the area and then record the time spent ripping. After the material has been removed, cross-section the area again to determine the volume of rock removed. The volume divided by the time spent ripping gives the ripping rate per minute or hour.
3. Timing the ripper over a measured distance is the least accurate method, but valuable for quick estimating on the job. An average cycle time should be determined from a number of timed cycles. Turn-around or back-up time must be included. Measure the average rip distance, rip spacing and depth of penetration. This data will give the volume per cycle from which the production in bank cubic yards can be calculated. Experience has shown results obtained from this method are about 10 to 20% higher than the more accurate method of cross-sectioning.

An example of the measured distance method for calculating ripper production is:

Data — D10R — No. 10 with one shank.
910 mm (36 in) between passes.
1.6 km/h (1 mph) average speed (including slippage and stalls).

Every 91 m (300 ft) requires 0.25 min to raise, pivot, turn, and lower again: 91 m (300 ft) = 1 pass.

610 mm (24 in) penetration.
Full time ripping (no pushing or dozing assignment).

Example of Estimating Production (Metric)

Time per pass:

1.6 km/h = 26.7 m/min. Then $\frac{91 \text{ m}}{26.7 \text{ m/min}} = 3.41 \text{ min}$;

3.41 min + 0.25 min (turn time) = 3.66 min/pass.

If the operator works an average of 45 min per h, it is possible to make $= \frac{45}{3.66} = 12.3$ passes per h

Volume ripped: $91 \text{ m} \times 0.9 \text{ m} \times 0.6 \text{ m} = 49.1 \text{ BCM}$ per pass

Production = $49.1 \times 12.3 = 604 \text{ BCM}$ per h

Remember the results from this method are usually 10 to 20 per cent higher than the actual production that can be expected on the job.

• • •

Example of Estimating Production (English)

Time per pass:

MPH = 88 fpm. Then $\frac{300 \text{ ft}}{88 \text{ fpm}} = 3.41 \text{ min}$;

3.41 min + 0.25 min. (turn time) = 3.66 min/pass.

If the operator works an average of 45 min per hr, it is possible to make $\frac{45}{3.66} = 12.3$ passes per hr

Volume ripped: $\frac{300 \times 3 \times 2}{27} = 66.7 \text{ BCY}$ per pass

Production = $66.7 \times 12.3 = 820 \text{ BCY}$ per hr

• • •

NOTE: The demands of heavy ripping will increase the normal owning and operating costs of the tractor.

These costs should be increased no less than 30-40% in heavy ripping applications to estimate rock loosening costs.

There is no ready answer or rule-of-thumb solution to predict ripping production. Even if everything is known about the seismic velocity of the material, its composition, job conditions, equipment and operator, only a "guesstimate" can be given. The final answer must come from a production study obtained on the job site.

Sample problem (Metric)

Determine the loosening costs in the following situation:

Machine	— D10R Tractor with No. 10 Single Shank Ripper
Rip Spacing	— 915 mm
Ripper Penetration	— 610 mm
Rip Distance	— 91 m
Rip Time	— 3.41 minutes
Maneuver Time	— 0.25 minutes
Seismic Velocity	— 1830 meters per second
Assume	60 min. hour

Solution:

1. Total Cycle Time = $3.41 + 0.25 = 3.66 \text{ min}$

$$\text{Cycles/hour} = \frac{60 \text{ min/hr}}{3.66 \text{ min/cycle}} = 16.4$$

2. Production per cycle = $91 \text{ m} \times 0.9 \text{ m} \times 0.6 \text{ m} = 49.1 \text{ BCM/cycle}$

3. Production = $49.1 \text{ BCM/cycle} \times 16.4 \text{ cycles/h} = 805 \text{ BCM/h}$

4. Remember results of this method are usually 10 to 20% high.

Actual Production = 80% of 805 BCM/h = 644 BCM/h

Or 90% of 805 BCM/h = 725 BCM/h

5. Owning and Operating Costs

AD10R (ripping only) could have a \$115.00/h O & O costs including \$30/h operator.

6. Loosening Costs

$\$115.00/\text{hr} \div 644 \text{ BCM/h} = \$0.179/\text{BCM}$

$\$115.00/\text{hr} \div 725 \text{ BCM/h} = \$0.159/\text{BCM}$

The loosening cost should range from 15.9¢ to 17.9¢/BCM

• • •

Sample problem (English)

Determine the loosening costs in the following situation:

Machine	— D10R Tractor with No. 10 Single Shank Ripper
Rip Spacing	— 3 feet
Ripper Penetration	— 2 feet
Rip Distance	— 300 feet
Rip Time	— 3.41 minutes
Maneuver Time	— 0.25 minutes
Seismic Velocity	— 6,000 feet per second
Assume	60 min. hour

Solution:

1. Total Cycle Time = 3.41 + 0.25 = 3.66 min

$$\text{Cycles/hour} = \frac{60 \text{ min/hr}}{3.66 \text{ min/cycle}} = 16.4$$
2. Production per cycle = $\frac{300 \times 3 \times 2}{27} = 66.7$
 BCY/cycle
3. Production = 66.7 BCY/cycle \times 16.4 cycles/hr
 = 1094 BCY/hour
4. Remember results of this method are usually
 10 to 20% high.
 Actual Production = 80% \times 1094
 = 875 BCY/hr
 or 90% \times 1094 = 984 BCY/hr
5. Owning and Operating Costs
 A D10R (ripping only) could have a \$115.00/hr
 O & O cost including \$30/hr operator
6. Loosening Costs
 \$115.00/hr \div 875 BCY/hr = \$0.131/BCY
 \$115.00/hr \div 984 BCY/hr = \$0.117/BCY
 The loosening cost should range from 11.7¢ to
 13.1¢/BCY



USE OF SEISMIC VELOCITY CHARTS

The charts of ripper performance estimated by seismic wave velocities have been developed from field tests conducted in a variety of materials. Considering the extreme variations among materials and even among rocks of a specific classification, the charts must be recognized as being at best only one indicator of rippability.

Accordingly, consider the following precautions when evaluating the feasibility of ripping a given formation:

- Tooth penetration is often the key to ripping success, regardless of seismic velocity. This is particularly true in homogeneous materials such as mudstones and claystones and the fine-grained caliches. It is also true in tightly cemented formations such as conglomerates, some glacial tills and caliches containing rock fragments.

- Low seismic velocities of sedimentaries can indicate probable rippability. However, if the fractures and bedding joints do not allow tooth penetration, the material may not be ripped effectively.
- Pre-blasting or “popping” may induce sufficient fracturing to permit tooth entry, particularly in the caliches, conglomerates and some other rocks; but the economics should be checked carefully when considering popping in the higher grades of sandstones, limestones and granites.

Ripping is still more art than science, and much will depend on operator skill and experience. Ripping for scraper loading may call for different techniques than if the same material is to be dozed away. Cross-ripping requires a change in approach. The number of shanks used, length and depth of shank, tooth angle, direction, throttle position — all must be adjusted according to field conditions. Ripping success may well depend on the operator finding the proper combination for those conditions.

NOTE: Field Seismic Information shown in the following charts is the best single indication of rippability. However, Caterpillar does not rely on any single parameter to select the best machine for your particular operation and rock type. Field Seismic Information is just one aspect of a complete rippability analysis that can be obtained through your Caterpillar dealer. A Caterpillar rippability analysis includes a geological site survey, field seismic velocity measurements, laboratory analysis of rock properties and an equipment investment analysis. Contact your Caterpillar dealer for a complete rippability analysis.

D8R

- Multi or Single Shank No. 8 Ripper
- Estimated by Seismic Wave Velocities

Seismic Velocity

Meters Per Second × 1000

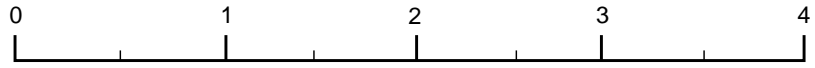

Feet Per Second × 1000

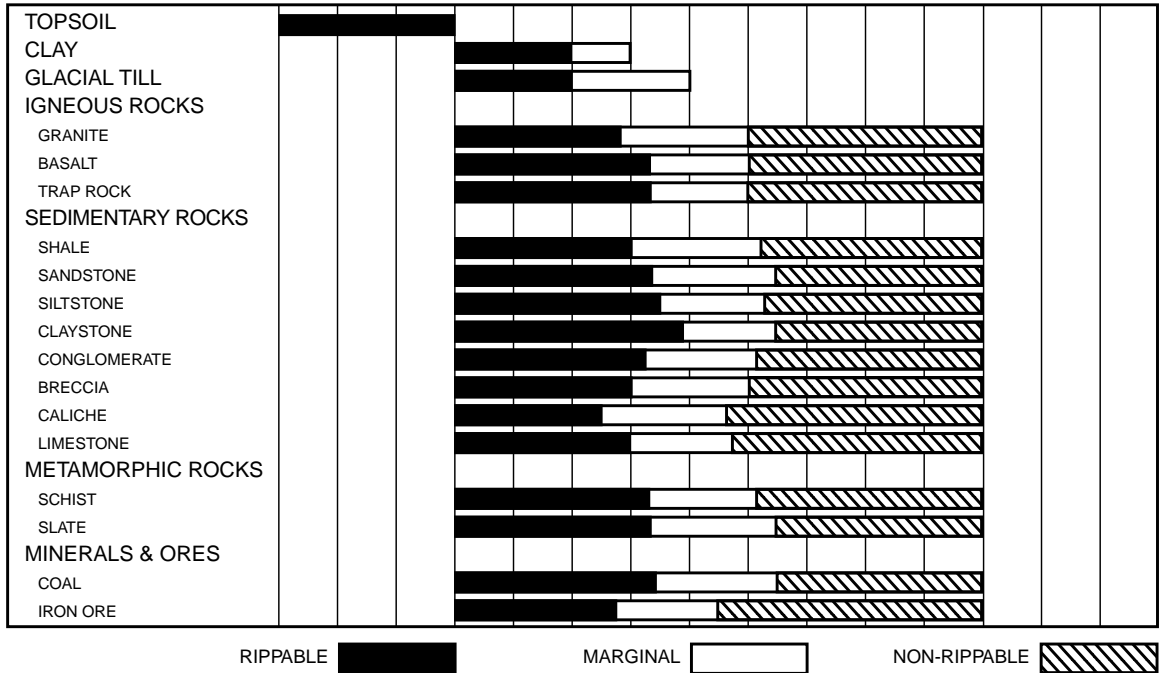

RIPPABLE



MARGINAL



NON-RIPPABLE



D9R

- Multi or Single Shank No. 9 Ripper
- Estimated by Seismic Wave Velocities

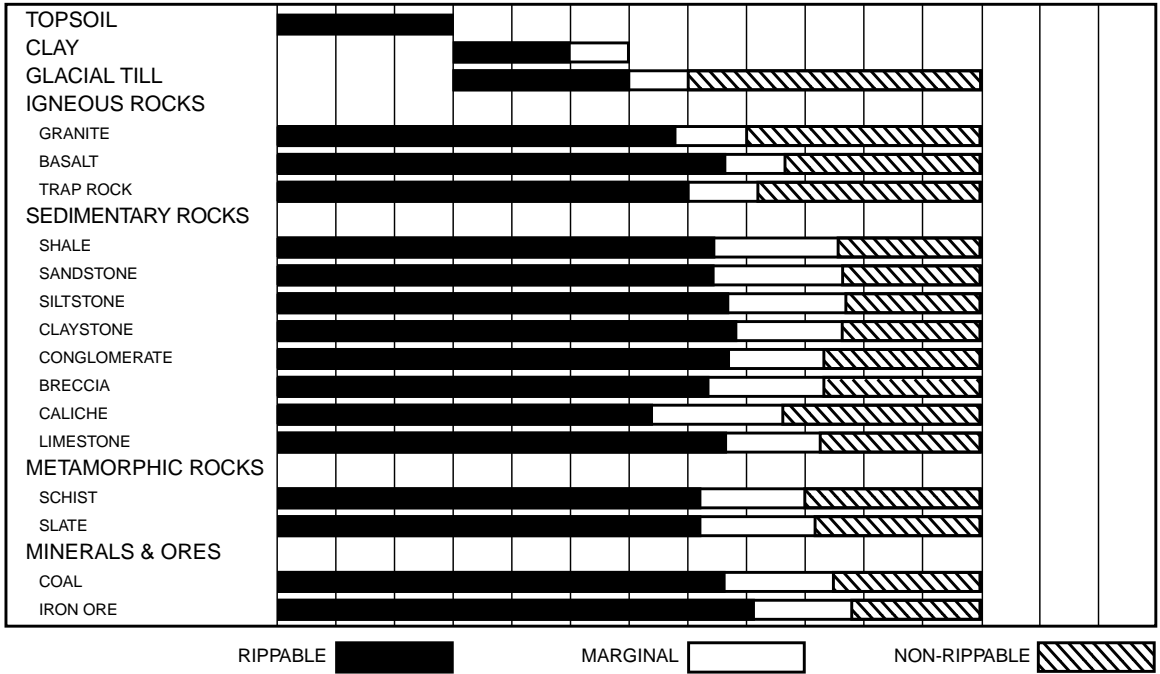

D10R

- Multi or Single Shank No. 10 Ripper
- Estimated by Seismic Wave Velocities

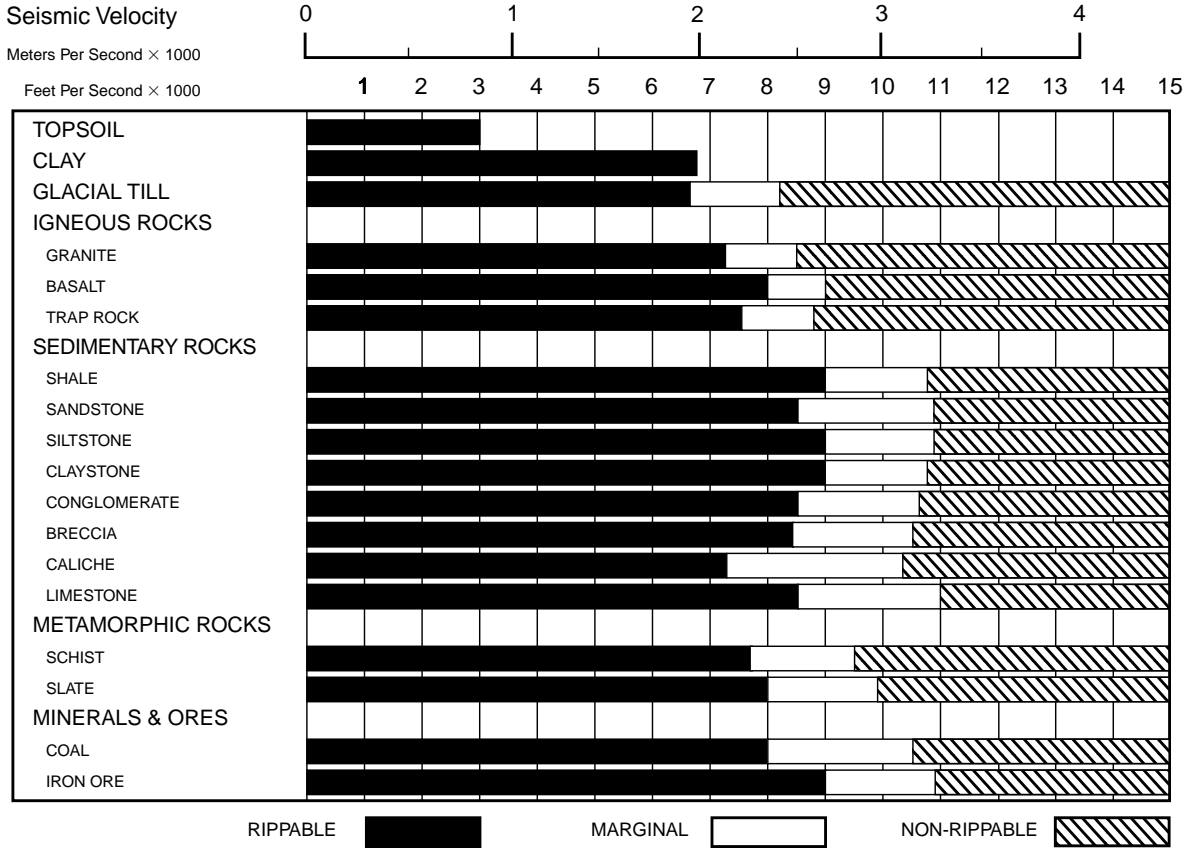

D11R

- Multi or Single Shank No. 11 Ripper
- Estimated by Seismic Wave Velocities

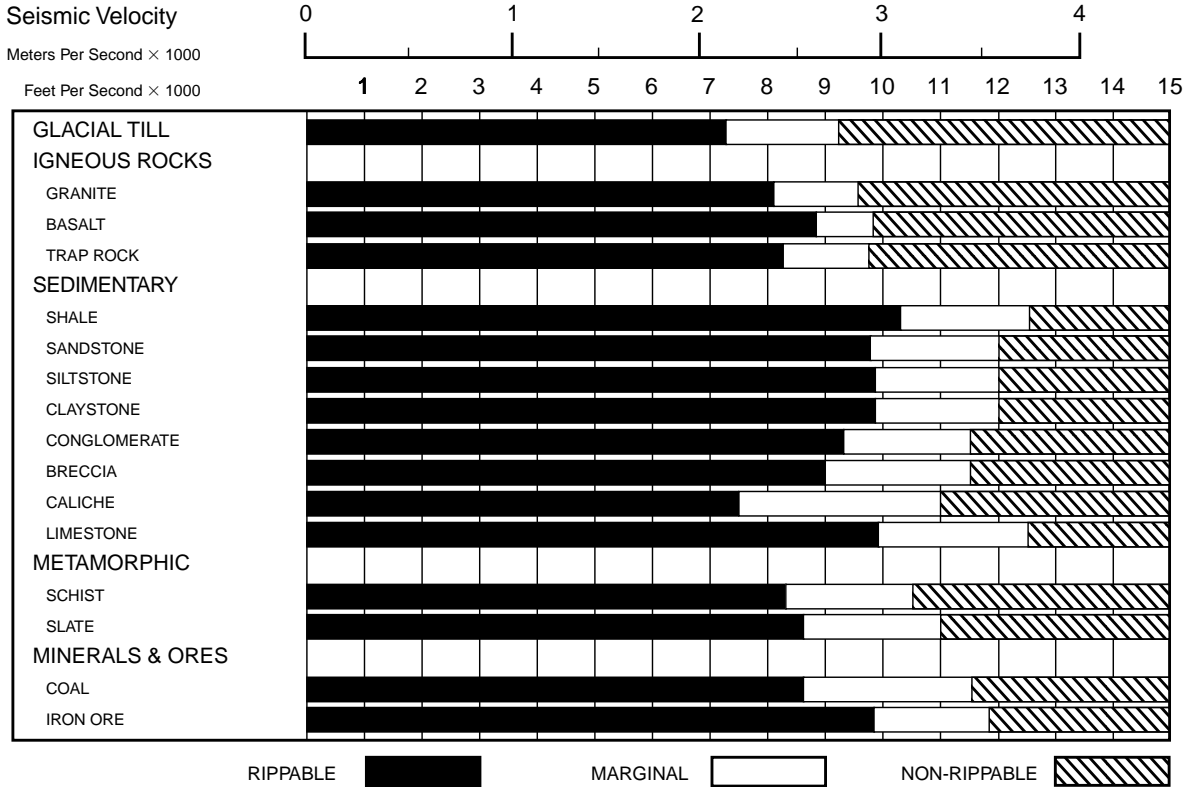

D11R C.D.

- Single Shank No. 11 Ripper
- Estimated by Seismic Wave Velocities

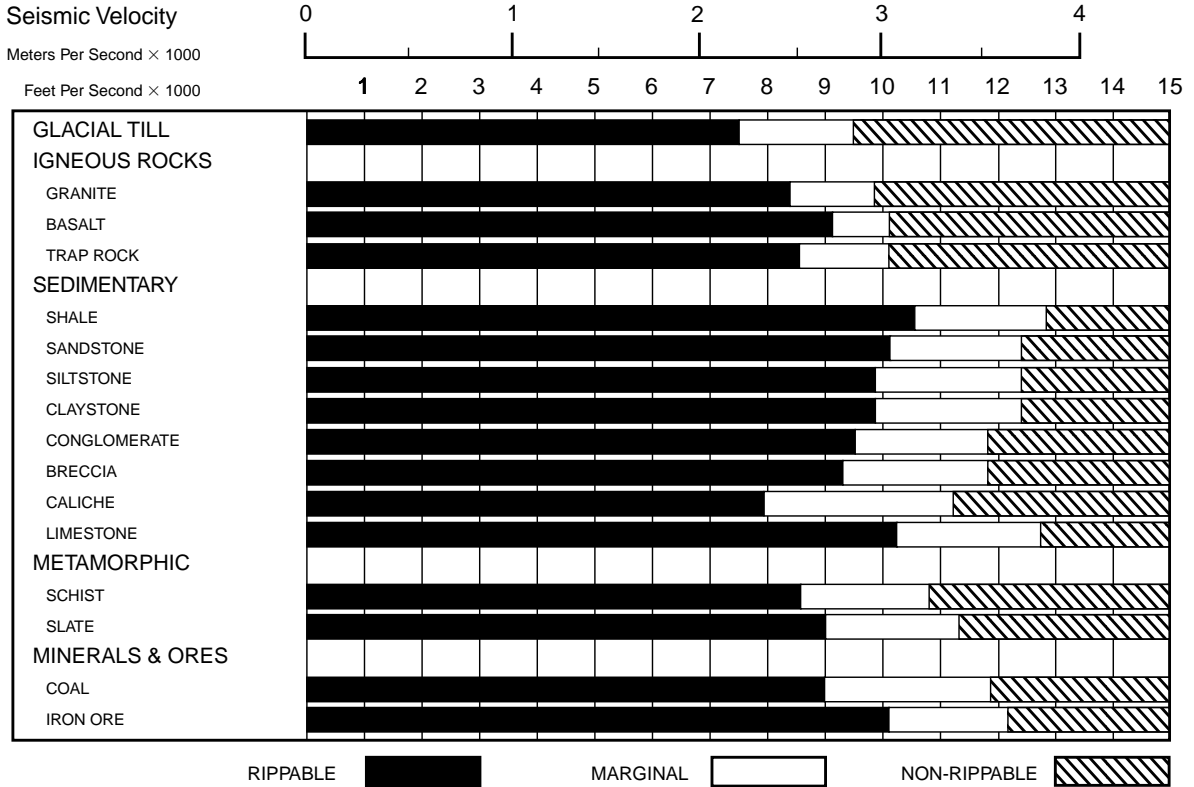

CONSIDERATIONS FOR USING PRODUCTION ESTIMATED GRAPHS:

- Machine rips full-time — no dozing.
- Power shift tractors with single shank rippers.
- 100% efficiency (60 min hour).
- Charts are for all classes of material.
- In igneous rock with seismic velocity of 8000 fps or higher for the D11R, and 6000 fps or higher for the D10R, D9R and D8R, the production figures shown should be reduced by 25%.
- Upper limit of charts reflect ripping under ideal conditions only. If conditions such as thick lamination, vertical lamination or any factor which would adversely affect production are present, the lower limit should be used.

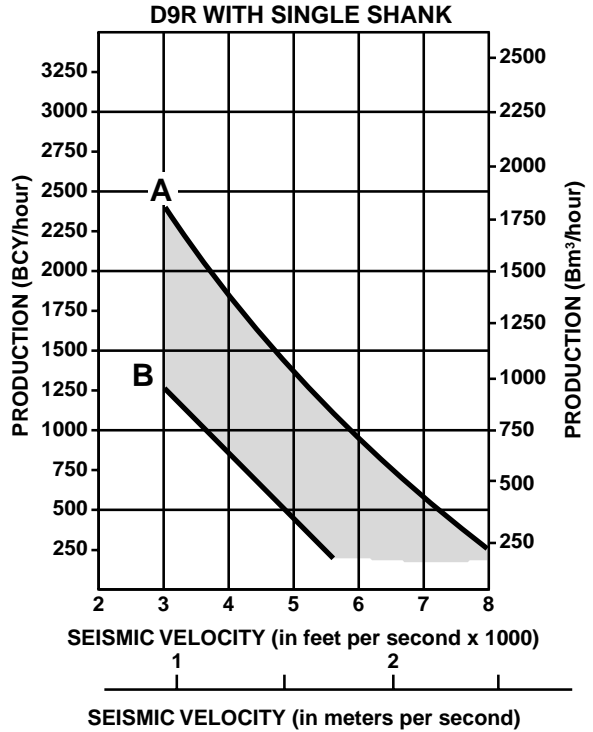
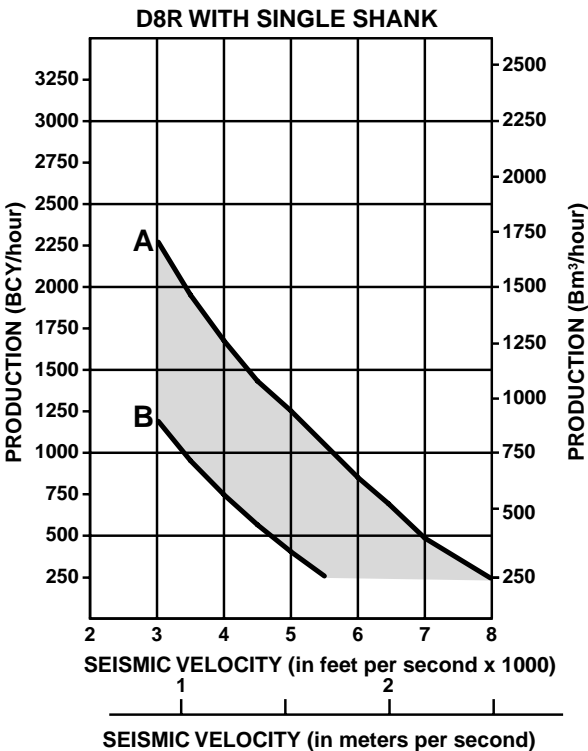

KEY
 A — IDEAL
 B — ADVERSE

D10R WITH SINGLE SHANK

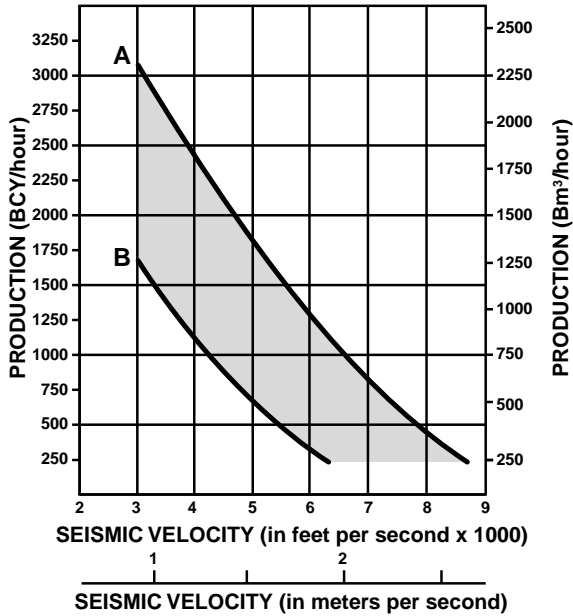

D11R WITH SINGLE SHANK

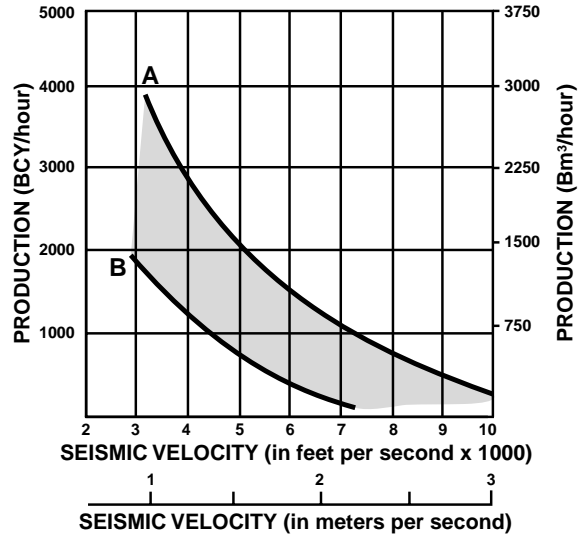

D11R C.D. WITH SINGLE SHANK

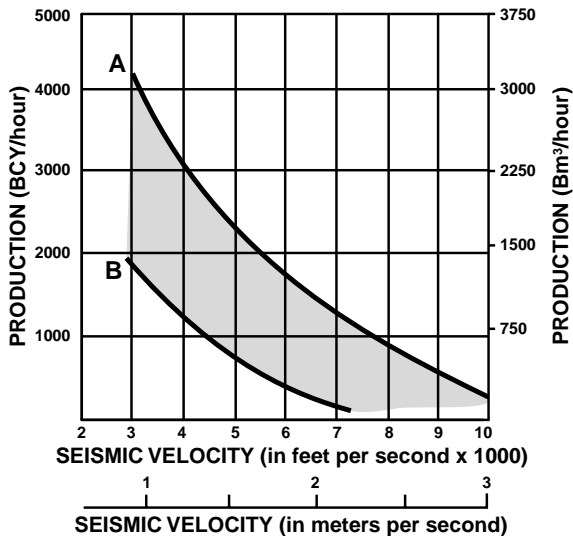

KEY

- A — IDEAL
- B — ADVERSE

WINCHES

CONTENTS

Features	1-77
Physical specifications	1-78
Operating specifications	1-81

PA55 & PA56 Standard Features:

- **Rigid cast ductile case** with integral fairlead mounting lugs and heavy duty drawbar provides durable construction for long life and maximum resale value.
- **Internal Hydraulic System** with gear pump and maintenance free spring type accumulator for easy installation and maintenance.
- **Equal speed gearing** in forward and reverse to provide smooth and predictable performance.
- **Single lever control**, electronic on PA56 or cable control on PA55 for hydraulically actuated multiple disc clutches, brake, and freespool for ease of operation.
- **Freespool with drag adjustment** so the operator can easily pull wire rope from the drum by hand, permitting fast one man operation.

PA57G & Cat 59 Standard Features:

- **Adjust-free oil-disc clutches** in winch assure reliable performance day-in, day-out.
- **Input clutch** reduces parasitic horsepower loss for improved fuel efficiency.
- **Single-lever actuation** of both clutch and brake functions ... automatic synchronization of input and directional clutch engagement for smooth control.
- **Equal speed gearing** in reel-in and reel-out to provide smooth and predictable performance.

PA57VS, PA58VS & PA59VS Standard Features:

- **Variable** line pull and line speed.
- **Hydraulically driven winch** for precise load control in reel-in or reel-out.
- **Inching control** through modulation of variable displacement pump and motor.
- **Dual braking system** provides a static brake with a sprag clutch to eliminate fall back and a brake valve for dynamic braking.
- **Single lever joy stick control** for ease of operation and reliable performance with no cable nor linkage adjustments.
- **Three roller fairlead** is standard for improved wire rope life during side pulls.

PA55 & PA56

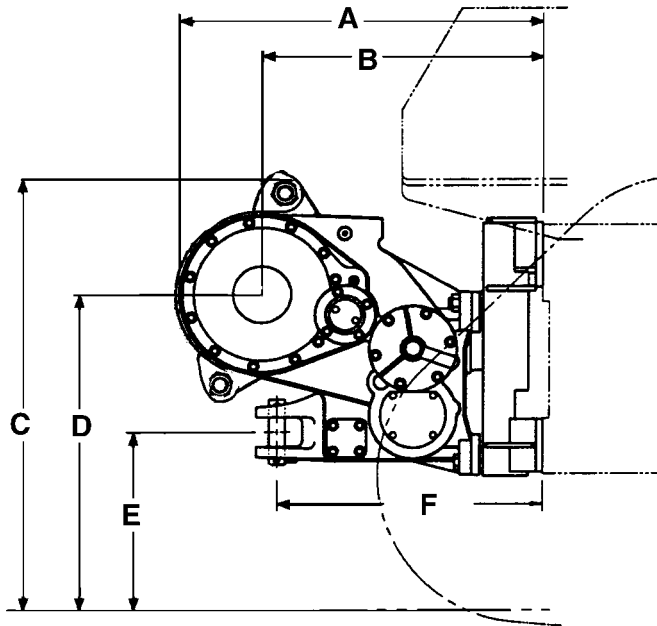

WINCH MODEL	PA55							
TRACTOR MODEL	D5M XL		D5M LGP		D6M XL		D6M LGP	
Transmission	PS		PS & DD					
A Tractor to rear of winch	1120 mm	3'8.1"	1120 mm	3'8.1"	1120 mm	3'8.1"	1120 mm	3'8.1"
B Tractor to drum centerline	866 mm	2'10.1"	866 mm	2'10.1"	866 mm	2'10.1"	866 mm	2'10.1"
C Ground to top of winch	1328 mm	4'4.3"	1380 mm	4'6.3"	1396 mm	4'7"	1511 mm	4'11.5"
D Ground to drum centerline	960 mm	3'1.8"	1012 mm	3'3.8"	1028 mm	3'4.5"	1142 mm	3'9"
E Ground to center of hitch	526 mm	1'8.7"	578 mm	1'10.7"	594 mm	1'11.4"	708 mm	2'3.9"
F Tractor to pin centerline	818 mm	2'8.2"	818 mm	2'8.2"	818 mm	2'8.2"	818 mm	2'8.2"
Overall width (not shown)	1080 mm	3'6.5"	1080 mm	3'6.5"	1080 mm	3'6.5"	1080 mm	3'6.5"
Drum diameter (not shown)	254 mm	10"	254 mm	10"	254 mm	10"	254 mm	10"
Weight*	1276 kg	2810 lb	1276 kg	2810 lb	1276 kg	2814 lb	1276 kg	2814 lb
Oil refill capacity	74 L	19.5 U.S. gal	74 L	19.5 U.S. gal	74 L	19.55 U.S. gal	74 L	19.55 U.S. gal
Wire rope diameter:								
Recommended	16 mm	0.63"	16 mm	0.63"	19 mm	0.75"	19 mm	0.75"
Optional	19 mm	0.75"	19 mm	0.75"	22 mm	0.87"	22 mm	0.87"
Drum capacity:								
Recommended rope	177 m	581'	177 m	581'	122 m	400'	122 m	400'
Optional rope	122 m	400'	122 m	400'	88 m	289'	88 m	289'
Wire rope ferrule size								
(OD × length)	54 ×	2.13 ×	54 ×	2.13 ×	54 ×	2.13 ×	54 ×	2.13 ×
	65 mm	2.56"	65 mm	2.56"	65 mm	2.56"	65 mm	2.56"

*Includes pump, operator controls, oil, mounting brackets, spacers and wire rope.

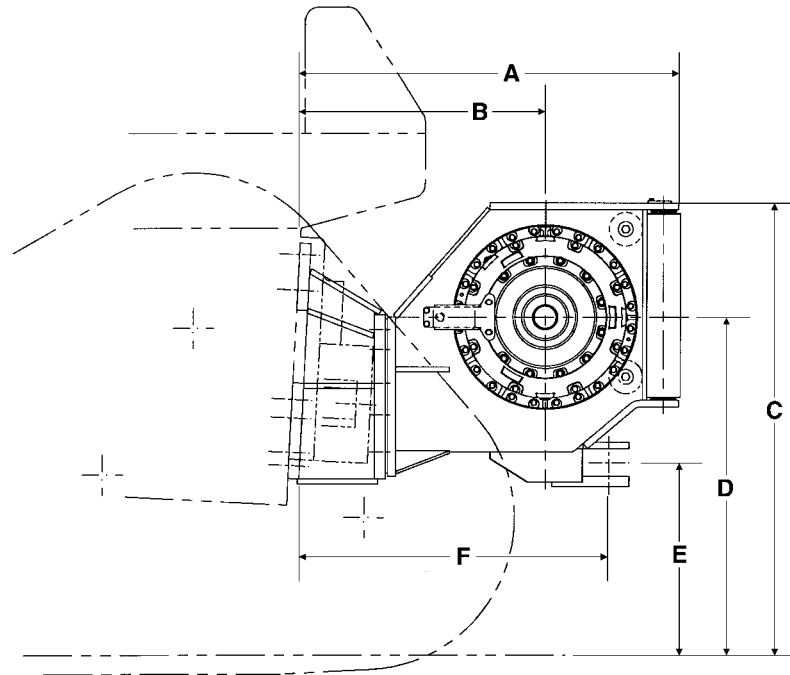

WINCH MODEL	PA56		PA57G		PA57VS	
TRACTOR MODEL	D6R		D7G		D7R	
A Tractor to rear of winch	1200 mm	3'11.2"	973 mm	3'2.3"	1435 mm	4'8.5"
B Tractor to drum centerline	945 mm	3'1.2"	693 mm	2'3.3"	940 mm	3'1"
C Ground to top of winch	1475 mm	4'10.1"	1570 mm	5'1.7"	1570 mm	5'1.8"
D Ground to drum centerline	1110 mm	3'7.6"	1176 mm	3'10.3"	1130 mm	3'8.5"
E Ground to center of hitch	680 mm	2'2.7"	610 mm	2'0"	579 mm	1'10.8"
F Tractor to pin centerline	915 mm	3'0"	752 mm	2'5.6"	1216 mm	3'11.9"
Overall width (not shown)	975 mm	3'2.3"	1148 mm	3'9.2"	1158 mm	3'9.6"
Drum diameter (not shown)	254 mm	10"	305 mm	12"	318 mm	12.5"
Weight*	1135 kg	2503 lb	1727 kg	3800 lb	1790 kg	3950 lb
Oil refill capacity	67 L	17.75 U.S. gal	81 L	21.5 U.S. gal	15 L	4 U.S. gal
Wire rope diameter:						
Recommended	22 mm	0.88"	25 mm	1"	29 mm	1.13"
Optional	25 mm	1"	29 mm	1.13"	32 mm	1.25"
Drum capacity:						
Recommended rope	88 m	290'0"	73 m	239'0"	84 m	276'0"
Optional rope	67 m	220'0"	58 m	190'0"	59 m	193'0"
Wire rope ferrule size (OD × length)	54 × 67 mm	2.10 × 2.63"	60 × 70 mm	2.38 × 2.75"	60 × 70 mm	2.38 × 2.75"

*Operating weight includes pump and operator controls.

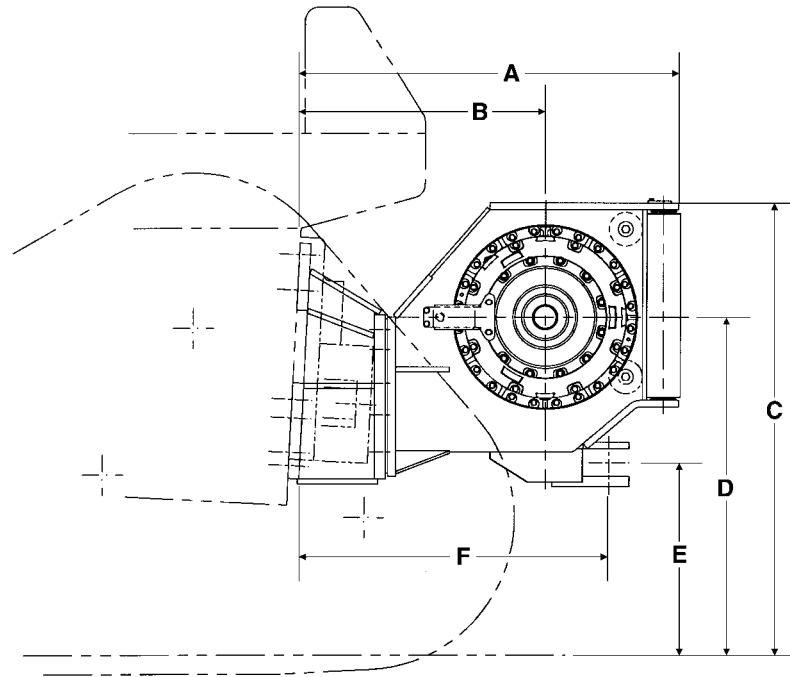

WINCH MODEL	PA58VS		PA59VS		59	
TRACTOR MODEL	D8R		D9R		D10R	
A Tractor to rear of winch	1435 mm	4'8.5"	1552 mm	5'1.1"	1247 mm	4'1.1"
B Tractor to drum centerline	940 mm	3'1"	1041 mm	3'5"	942 mm	3'1.1"
C Ground to top of winch	1712 mm	5'7.4"	1738 mm	5'8.4"	1787 mm	5'10.4"
D Ground to drum centerline	1273 mm	4'2.1"	1298 mm	4'3.1"	1480 mm	4'10.3"
E Ground to center of hitch	721 mm	2'4.4"	747 mm	2'5.4"	892 mm	2'11.1"
F Tractor to pin centerline	1216 mm	3'11.9"	1282 mm	4'2.5"	1000 mm	3'3.4"
Overall width (not shown)	1158 mm	3'9.6"	1158 mm	3'9.6"	1564 mm	5'1.6"
Drum diameter (not shown)	318 mm	12.5"	318 mm	12.5"	330 mm	13"
Weight*	1790 kg	3950 lb	1860 kg	4100 lb	2184 kg	4805 lb
Oil refill capacity	15 L	4 U.S. gal	15 L	4 U.S. gal	70 L	18.5 U.S. gal
Wire rope diameter:						
Recommended	29 mm	1.13"	29 mm	1.13"	29 mm	1.13"
Optional	32 mm	1.25"	32 mm	1.25"	32 mm	1.25"
Drum capacity:						
Recommended rope	84 m	276'0"	84 m	276'	69 m	226'
Optional rope	59 m	193'0"	59 m	193'	55 m	180'
Wire rope ferrule size (OD 3 length)	60 × 70 mm	2.38 × 2.75"	60 × 70 mm	2.38 × 2.75"	60 × 70 mm	2.38 × 2.75"

*Operating weight includes pump and operator controls.

WINCH MODEL		PA55		PA56	PA57G
TRACTOR MODEL		D5M	D6M	D6R	D7G
British Units of Measure <i>Standard speed gearing</i>					
Winch Drive		PTO	PTO	PTO	PTO
Bare Drum	Rated Linepull	26,730	37,510	54,180	53,939
	Maximum linepull*	51,200	69,200	89,800	103,794
	Rated linespeed	97	94	78	89
	Maximum linespeed	151	143	122	159
Full Drum	Rated linepull	15,020	21,080	31,570	33,712
	Maximum linepull	36,760	53,590	64,970	64,871
	Rated linespeed	173	168	134	143
	Maximum linespeed	269	254	209	254
<i>Slow/Low speed gearing</i>					
Bare Drum	Rated linepull*	51,200	69,200	89,800	113,000
	Maximum linepull*	51,200	69,200	89,800	113,000
	Rated linespeed	41	39	35	37
	Maximum linespeed	63	60	55	66
Full Drum	Rated linepull	36,020	50,570	69,340	81,429
	Maximum linepull*	51,200	69,200	89,800	113,000
	Rated linespeed	72	70	61	59
	Maximum linespeed	112	106	95	105
Tractor rating		110 hp @ 2100 rpm	140 hp @ 2200 rpm	165 hp @ 1800 rpm	200 hp @ 2000 rpm
Metric Units of Measure <i>Standard speed gearing</i>					
Bare Drum	Rated Linepull	12 120	17 014	24 576	24 446
	Maximum linepull*	23 245	31 417	40 733	47 080
	Rated linespeed	30	29	24	27
	Maximum linespeed	46	44	37	48
Full Drum	Rated linepull	6813	9562	14 320	15 292
	Maximum linepull	16 674	24 471	29 470	29 425
	Rated linespeed	53	51	41	44
	Maximum linespeed	82	77	64	77
<i>Slow/Low speed gearing</i>					
Bare Drum	Rated linepull*	23 245	31 417	40 733	51 256
	Maximum linepull*	23 245	31 417	40 733	51 256
	Rated linespeed	12	12	11	11
	Maximum linespeed	19	18	17	20
Full Drum	Rated linepull	16 338	22 938	31 453	36 935
	Maximum linepull*	23 245	31 417	40 733	51 256
	Rated linespeed	22	21	19	18
	Maximum linespeed	34	32	29	32
Tractor rating		82 kW @ 2100 rpm	104 kW @ 2200 rpm	123 kW @ 1800 rpm	149 kW @ 2000 rpm

*Maximum linepull limited by breaking strength of the optional (larger diameter) wire rope.
 Winch linepull and linespeed ratings are based on gear train mechanical efficiency of 90%.

Winches

- Operating Specifications
- British Units of Measure
 - Metric Units of Measure

WINCH MODEL		PA57VS		PA58VS	PA59VS	59
TRACTOR MODEL		D7R Diff. Steer	D7R Power Shift	D8R	D9R	D10
British Units of Measure						
<i>Standard speed gearing</i>						
Winch Drive		HYD	HYD	HYD	HYD	PTO
Bare Drum	Rated linepulllbs	35,960	—	—	—	122,110
	Maximum linepulllbs	109,657	—	—	—	139,000*
	Rated linespeed fpm	132	—	—	—	116
	Maximum linespeed fpm	167	—	—	—	149
Full Drum	Rated linepulllbs	22,820	—	—	—	82,620
	Maximum linepulllbs	69,587	—	—	—	139,000*
	Rated linespeed fpm	208	—	—	—	171
	Maximum linespeed fpm	264	—	—	—	221
<i>Slow/Low speed gearing</i>						
Bare Drum	Rated linepulllbs	107,800	101,200	109,700	120,200	139,000*
	Maximum linepulllbs	107,800	101,200	109,700	120,200	139,000*
	Rated linespeed fpm	32	22	30	33	63
	Maximum linespeed fpm	95	63	61	62	81
Full Drum	Rated linepulllbs	69,700	65,500	71,000	72,400	139,000*
	Maximum linepulllbs	69,700	65,500	71,000	72,400	139,000*
	Rated linespeed fpm	49	35	46	55	97
	Maximum linespeed fpm	147	79	95	104	121
Tractor rating		240 hp @ 2100 rpm	240 hp @ 2100 rpm	305 hp @ 2100 rpm	405 hp @ 1900 rpm	570 hp @ 1900 rpm
Metric Units of Measure						
<i>Standard speed gearing</i>						
Bare Drum	Rated linepullkg	16 326	—	—	—	55 389
	Maximum linepullkg	49 784	—	—	—	63 106*
	Rated linespeedmpm	40	—	—	—	35
	Maximum linespeedmpm	51	—	—	—	46
Full Drum	Rated linepullkg	10 360	—	—	—	37 476
	Maximum linepullkg	31 592	—	—	—	63 106*
	Rated linespeedmpm	63	—	—	—	52
	Maximum linespeedmpm	81	—	—	—	67
<i>Slow/Low speed gearing</i>						
Bare Drum	Rated linepullkg	48 941	45 945	49 804	54 571	63 106*
	Maximum linepullkg	48 941	45 945	49 804	54 571	63 106*
	Rated linespeedmpm	10	7	9	10	19
	Maximum linespeedmpm	29	16	19	19	25
Full Drum	Rated linepullkg	31 644	29 737	32 234	32 870	63 106*
	Maximum linepullkg	31 644	29 737	32 234	32 870	63 106*
	Rated linespeedmpm	15	11	14	17	30
	Maximum linespeedmpm	45	24	29	32	37
Tractor rating		179 kW @ 2100 rpm	197 kW @ 2100 rpm	228 kW @ 2100 rpm	302 kW @ 1900 rpm	425 kW @ 1900 rpm

*Maximum linepull limited by breaking strength of the optional (larger diameter) wire rope.
Winch linepull and linespeed ratings are based on gear train mechanical efficiency of 90%.

TOWED SCRAPERS

PRODUCTION BASIS FOR ALL TABLES IN THIS SECTION:

- Material 1780 kg/m³ (3000 lb/yd³).
- 60 minute hour.
- Total resistance 100 kg/metric ton ~ (200 lb/U.S. ton).
- Scraper load per trip estimated at rated struck capacity.

- All hydraulic
- Manufactured by Rome Industries

SCRAPER & TRACTOR	Struck Capacity		Haul 120 m 400'		Haul 180 m 600'		Haul 250 m 800'		Haul 300 m 1000'	
	m ³	yd ³	m ³	yd ³	m ³	yd ³	m ³	yd ³	m ³	yd ³
Push Loaded			Estimated Hourly Production							
R56H	m ³	yd ³	m ³	yd ³	m ³	yd ³	m ³	yd ³	m ³	yd ³
D6M (Power Shift)	6.9	9.0	107	140	88	115	75	98	66	86
D6M (Direct Drive)	6.9	9.0	101	132	83	109	71	93	61	80
D5B (Power Shift)	6.9	9.0	105	138	86	113	74	96	63	83
D5B (Direct Drive)	6.9	9.0	104	136	87	114	75	98	65	85
D6R (Power Shift)	6.9	9.0	125	164	102	133	86	113	75	98
D6R (Direct Drive)	6.9	9.0	128	168	108	141	93	121	82	107
D6D (Power Shift)	6.9	9.0	123	161	99	130	84	110	73	95
D6D (Direct Drive)	6.9	9.0	125	163	104	136	89	116	78	102
Self Loaded										
D6M (Power Shift)	6.9	9.0	95	124	80	104	69	90	61	80
D6M (Direct Drive)	6.9	9.0	89	117	75	98	64	84	57	75
D5B (Power Shift)	6.9	9.0	93	122	78	102	67	88	59	77
D5B (Direct Drive)	6.9	9.0	92	121	79	103	68	89	60	79
D6R (Power Shift)	6.9	9.0	112	147	93	122	80	105	70	92
D6R (Direct Drive)	6.9	9.0	114	149	98	128	85	111	76	100
D6D (Power Shift)	6.9	9.0	110	144	91	119	78	102	68	89
D6D (Direct Drive)	6.9	9.0	111	145	94	123	82	107	73	95

Load time (average):

	Push Loaded	Self Loaded
D5	1.0 min	1.5 min
D6	0.8 min	1.2 min

Dump and turn time: D5 1.2 min

D6 1.0 min

Shift time: P.S. 0.0 min

D.D. 0.2 min

SCRAPER & TRACTOR	Struck Capacity		Haul 120 m 400'		Haul 180 m 600'		Haul 250 m 800'		Haul 300 m 1000'	
	m ³	yd ³	m ³	yd ³	m ³	yd ³	m ³	yd ³	m ³	yd ³
Push Loaded			Estimated Hourly Production							
R67H										
D6R (Power Shift)	9.2	12	161	210	130	170	109	142	93	121
D6R (Direct Drive)	9.2	12	144	188	119	156	102	133	86	113
D6D (Power Shift)	9.2	12	152	200	122	160	100	132	85	112
D6D (Direct Drive)	9.2	12	140	183	114	150	97	127	82	108
D7R (Power Shift)	9.2	12	208	272	169	221	140	183	118	154
D7R (Direct Drive)	9.2	12	206	270	172	225	145	190	126	165
D7G (Power Shift)	9.2	12	198	260	159	208	131	172	110	144
D7G (Power Shift)	10.7	14	222	291	177	232	151	198	126	165
D7G (Direct Drive)	10.7	14	215	281	168	221	146	191	123	162
D8R (Power Shift)	10.7	14	238	312	191	250	159	208	137	180
D8K (Power Shift)	10.7	14	238	312	191	250	159	208	137	180
D8K (Direct Drive)	10.7	14	228	298	181	238	152	200	132	173
R89H										
D7R (Power Shift)	13.8	18	257	336	206	269	170	222	147	192
D7R (Direct Drive)	13.8	18	240	314	194	254	160	209	141	185
D7G (Power Shift)	13.8	18	245	320	193	253	158	207	136	178
D7G (Direct Drive)	13.8	18	229	299	184	240	150	196	131	171
D8R (Power Shift)	13.8	18	275	360	213	278	176	230	151	198
D8K (Power Shift)	13.8	18	275	360	213	278	176	230	151	198
D8K (Direct Drive)	13.8	18	257	336	203	266	170	222	145	190
D8L (Power Shift)	13.8	18	325	425	155	328	207	271	179	234

Load time (average):

	Push	Self		Push	Self
R67H	Loaded	Loaded	R89H	Loaded	Loaded
D6	0.8 min	1.2 min	D7	0.8 min	1.2 min
D7	0.6 min	1.0 min	D8	0.6 min	1.0 min
D8	0.5 min	0.8 min	D8	0.5 min	0.8 min

Dump and turn time: D6

— 1.0 min

All others — 0.8 min

Shift time:

Power Shift — 0.0 min

Direct Drive — 0.2 min

SCRAPER & TRACTOR	Struck Capacity		Haul 120 m 400'		Haul 180 m 600'		Haul 250 m 800'		Haul 300 m 1000'	
	m ³	yd ³	m ³	yd ³	m ³	yd ³	m ³	yd ³	m ³	yd ³
Self Loaded										
Estimated Hourly Production										
R67H	m ³	yd ³	m ³	yd ³	m ³	yd ³	m ³	yd ³	m ³	yd ³
D6R (Power Shift)	9.2	12	143	187	119	156	101	132	88	115
D6R (Direct Drive)	9.2	12	134	175	112	147	95	124	82	107
D6D (Power Shift)	9.2	12	136	178	112	147	94	123	81	107
D6D (Direct Drive)	9.2	12	129	170	107	141	90	118	77	102
D7R (Power Shift)	9.2	12	187	244	151	197	128	168	109	142
D7R (Direct Drive)	9.2	12	174	227	136	178	113	148	97	129
D7G (Power Shift)	9.2	12	177	232	142	186	120	158	100	132
D7G (Direct Drive)	9.2	12	174	228	137	180	114	150	99	130
D7G (Power Shift)	10.7	14	194	255	160	210	137	180	116	152
D7G (Direct Drive)	10.7	14	189	248	156	205	133	175	113	149
D8R (Power Shift)	10.7	14	214	280	175	230	147	193	128	168
D8K (Power Shift)	10.7	14	214	280	175	230	147	193	128	168
D8K (Direct Drive)	10.7	14	206	270	168	220	143	180	123	162
R89H										
D7R (Power Shift)	13.8	18	229	299	189	247	156	204	129	169
D7R (Direct Drive)	13.8	18	216	283	179	234	151	198	128	168
D7G (Power Shift)	13.8	18	218	285	178	232	145	190	129	169
D7G (Direct Drive)	13.8	18	206	270	169	221	141	185	119	156
D8R (Power Shift)	13.8	18	238	312	192	251	162	212	141	184
D8K (Power Shift)	13.8	18	238	312	192	251	162	212	141	184
D8K (Direct Drive)	13.8	18	229	300	184	241	157	206	136	178
D8L (Power Shift)	13.8	18	281	368	226	296	191	250	166	217

Load time (average):

	Push	Self		Push	Self
R67H	Loaded	Loaded	R89H	Loaded	Loaded
D6	0.8 min	1.2 min	D7	0.8 min	1.2 min
D7	0.6 min	1.0 min	D8	0.6 min	1.0 min
D8	0.5 min	0.8 min	D8	0.5 min	0.8 min

Dump and turn time: D6 — 1.0 min
 All others — 0.8 min
 Shift time: Power Shift — 0.0 min
 Direct Drive — 0.2 min

SCRAPER & TRACTOR	Struck Capacity		Haul 100 m 330'		Haul 200 m 650'		Haul 300 m 1000'		Haul 400 m 1300'	
	m ³	yd ³	m ³	yd ³	m ³	yd ³	m ³	yd ³	m ³	yd ³
Estimated Hourly Production										
Agricultural	m ³	yd ³	m ³	yd ³	m ³	yd ³	m ³	yd ³	m ³	yd ³
2 × 6C + D4E DD	4.6	6	160	209	110	144	90	118	80	105
2 × 14C + D6D DD	10.7	14	380	497	270	353	210	275	175	229
Industrial										
1 × R89H + D8L	27.5	36	325	425	251	328	207	271	179	234

AGRICULTURAL EQUIPMENT

Challenger Tractors

Versatile Flotation System Trailers

LEXION Combines

Super Rural Tractors (SR)

CONTENTS

Features

Challenger Tractors	2-1
Versatile Flotation System	2-4
LEXION Combines	2-4
Super Rural Tractors	2-5

Specifications

Challenger Tractors	2-6
Versatile Flotation System	2-8
LEXION Combines	2-9
Super Rural Tractors	2-10

Horsepower Ratings

Challenger Tractors	2-11
Super Rural Tractors	2-11

Travel Speeds

Challenger Tractors	2-12
Super Rural Tractors	2-12

Drawbar Pull

Challenger Tractors	2-13
Super Rural Tractors	2-13

Row-Crop Gauge (Track) Spacing Guide

Angle Blade Specifications

Drawbar Power and Tillage

Estimated Draft or Drawbar Pull

CHALLENGER TRACTORS

Challenger Mid-Size Tractors

The Challenger 35, 45 and 55 tractors signal a new direction in row-crop versatility, with row spacing and horsepower to match most every cultivation, planting and tillage requirement.

Patented Mobil-trac™ Undercarriage:

- Exclusive Cat track design is industry's most advanced.
- Weight is spread across five axles, improving traction, flotation and lowering compaction.
- Translates more power to the ground for added performance, improved efficiency.
- Designed as an integral part of the Challenger tractor, not an "add-on."
- Hardbar elastomerically mounted for reduced vibration and smooth ride.
- Two locations allow convenient chemical tank mounting.

Exclusive Belt Design:

- Widest belt choice available: five widths — 406 to 813 mm (16"-32") — two tread-bar styles.
- Inside, patented arrangement of heavy-duty steel cables delivers maximum lateral resistance.
- Belt components are vulcanized, not molded, for excellent durability.

Gauge (Track) Spacing:

- Choice of two chassis (standard and wide-track) for maximum flexibility.
- Standard is adjustable from 1524 to 2286 mm (60"-90"); wide-track from 2032 to 3048 mm (80"-120").
- Adjustable in even, two-inch increments with solid, exacting settings and 100% true alignment.
- Track spacing changes made on-farm in a few hours and no special tools required.

Engines:

- Challenger 35, 45 feature Cat 3116 engine: 6.6 L (403 in³) displacement.
- Challenger 55 features Cat 3126 engine: 7.2 L (442 in³) displacement.
- Best-in-the-industry torque rise minimizes downshifting:
 - Challenger 35, 68% torque rise.
 - Challenger 45, 57% torque rise.
 - Challenger 55, 46% torque rise.
- Engine iso-mounted to tractor mainframe for simplified service.

16x9 Powershift Transmission:

- Programmable electronic powershift includes sequential shift, shuttle shift, auto-shift, programmable downshift/upshift, speed matching.
- Speed range from zero to 31.37 km/h (19.5 mph).
- Optional creeper gears allow for ultra slow-speed applications.
- Final drives feature inboard planetaries.

Patented Differential Steering:

- Hydraulic/mechanical design delivers smooth, reliable steering.
- Stronger and more durable than conventional electronic systems.
- Turning under load exceeds wheel tractor's ability, particularly at 3048 mm (120") setting.

Responsive Hydraulics:

- Ample hydraulic flow at couplers of 118 L/min (31.2 gpm).
- Hydraulic flow levers give comforting feeling of control.
- In-cab flow controls allow convenient fine-tuning.

Comfortable Cab:

- Excellent visibility all-around.
- Eight-way adjustable air-ride suspension seat for comfort.
- Patented rubber isolation mounts reduce shock loads, smooth operator ride and reduce noise levels.
- Movable control console allows adjustment for individual comfort.

Challenger High-Horsepower Tractors

The Challenger E-Series tractors take performance in the high-horsepower category to new levels. Worthy successors to the rugged Caterpillar D-Series, and the fifth generation to the original Challenger 65 introduced 12 years ago, the E-Series tractors are truly pulling the entire industry forward.

Patented Mobil-trac™ Undercarriage:

- Exclusive Cat track design is industry's most advanced.
- Weight is spread across six axles, improving traction, flotation and lowering compaction.
- Translates more power to the ground for added performance and improved efficiency.
- Designed as an integral part of the Challenger tractor, not an "add-on."
- Bogie undercarriage system absorbs shock loads, follows ground contours and smoothes ride.
- Choice of two drive wheels (chevron or heavy-duty slotted cast-iron).

Exclusive Belt Design:

- Widest belt choice available: four belt widths — 635, 762 and 889 mm (25", 30", 35") — in standard, special application, reinforced and side-hill versions.
- Inside, patented arrangement of heavy-duty steel cables delivers maximum lateral resistance.
- Belt components are vulcanized, not molded, for excellent durability.

Gauge (Track) Spacing:

- Standard 2286 mm (90") spacing provides improved debris rejection and stability.

Engines:

- Challenger 65E, 75E: Cat 3176C engine: 10.3 L (629 in³) displacement.
- Challenger 85E, 95E: Cat 3196 engine: 12 L (732 in³) displacement.
- Excellent torque rise minimizes downshifting:
 - Challenger 65E, 37% torque rise.
 - Challenger 75E, 41% torque rise.
 - Challenger 85E, 42% torque rise.
 - Challenger 95E, 43% torque rise.
- Power reserve of 10% at 1900 rpm on 95E allows exceptional pull-through in tough spots.
- Engine iso-mounted to tractor mainframe for simplified service.

10x2 Full Powershift Transmission:

- Dependable and proven; single in-line lever provides smooth on-the-go shifting in all gears.
- Speed range from zero to 31.7 km/h (19.7 mph).
- Inching pedal permits tight-quarter maneuvers; no need for high-maintenance master clutch.
- Fully hydraulic brake control reduces pedal effort.

Patented Differential Steering:

- Hydraulic/mechanical design delivers smooth, reliable steering.
- Effortless full-power turns under load.
- Mechanical system assures reliable steering under all conditions.
- “Straight-line” tracking allows straight forward pulling with minimal operator input.

Responsive Hydraulics:

- Ample hydraulic flow at couplers of 114 L/min (30 gpm).
- Power-beyond valve (standard) allows flow directly to implement orbital motors or fans.
- Remote, lever-actuated hydraulic couplers for easy connections.
- In-cab flow controls allow convenient fine-tuning.
- Hydraulic levers on the cab console positioned for easy control.

Comfortable Cab:

- Excellent visibility all-around — roomier, brighter, quieter cab improves productivity.
- Eight-way adjustable air-ride suspension seat.
- Fully padded trainer seat with retractable seat-belt.
- Isolation mounts absorb shock loads for smoother ride.
- Exclusive Caterpillar Information Display (optional) provides on-going log of maintenance data and field totals.

VERSATILE FLOTATION SYSTEM (VFS)

The heavy-duty VFS trailer system offers an extremely flexible hauling and spreading platform for grain wagons, spray tanks and other equipment. Certainly the most durable trailer system — track or wheel — available in the industry.

Solid Construction:

- Six axles per track roller frame spread out axle loads, lower rolling resistance.
- VFS 50 — four pressed high-strength low-alloy (HSLA) steel midwheels, two steel idlers.
- VFS 70 — ductile-iron midwheels; an additional layer of steel on idlers' outer diameter increases strength and load-carrying capacity.
- Dual tapered roller bearings on idlers and midwheels improve performance.
- Air-spring tensioning system allows recoil for material flow between belt and idler.
- Exclusive 762 mm (30") belts feature 96 tread bars and a 40-degree tread-bar pattern for traction, low vibration.

Adaptable:

- VFS 50 and 70 available in three configurations: hitch and frame, wide axle, or narrow axle.
- VFS 70 wide- and narrow-axle configurations include bracket-mounting location for weight scale.
- Each roller assembly oscillates up to 17 degrees, independent of the other, for a smooth ride.
- No lubrication required: special seals eliminate need for periodic greasing of midwheel and idler bearings.

Applications:

- Include but are not limited to the following:
 - Grain transport.
 - Sugar cane, vegetable or sugar beets hauling.
 - Lime spreading.
 - Anhydrous ammonia injection.
 - Sludge hauling.
 - Herbicide spreading.
 - Side-dump carts.
 - Air seeding.
 - Manure spreading.
- Construction uses include rear dump boxes and waste haulers.

LEXION COMBINES

After years of research, development and field testing, Caterpillar is pleased to offer the LEXION line of combines. This line represents the most significant advancement in combine technology and performance in more than two decades.

Headers:

- Auto-Contour automatically adjusts header height and tilt when traveling over uneven terrain.
- Automatic reel control synchronizes reel speed to travel speed and reel height to crop height.
- Auto-Pilot guidance system on corn heads offers "hands-free" steering control by sensing row location.
- Retractable fingers across the full length of the auger ensures that crop flows evenly into the feederhouse.
- Hydraulic header reverser for positive high-torque back-up of header and feederhouse to clear blockages.
- Multi-Link connector provides quick and simple hydraulic and electrical hook-up with just one connection point.

Threshing:

- Exclusive Accelerated Pre-Separation (APS) system separates out up to 30% of the grain before it moves to the threshing cylinder.
- At 1706 mm (67") the threshing cylinder is the widest in the industry.

Separation:

- LEXION 460 and 465 combines have six high-performance straw walkers (most competitive combines have only five).
- LEXION 480 and 485 combines use dual-rotor separation — a gentle, centrifugal-force system that produces high quality grain.

Cleaning:

- The long preparation pan, dual ventilation, and remote electric adjustment of the upper chaffer and lower sieve are exclusive to the LEXION.
- The optional 3-D sieve system compensates for slopes of up to 20%.
- Turbine fans are sectional, providing even air flow across the entire width of the cleaning area.

Engines:

- LEXION 460 and 465 combines feature the Cat 3126 engine — a 7.2 liter (439 cu. in.) engine producing 216 kW (290 hp). Power reserve of 222 kW (298 hp) is available at 2000 rpm.
- LEXION 480 and 485 combines are powered by the Cat 3176C engine — a 10.3 liter (629 cu. in.) engine producing 272 kW (365 hp). Power reserve of 280 kW (375 hp) is available at 2000 rpm.

Tracks and Tires:

- LEXION 465 and 485 combines feature Caterpillar's exclusive Mobil-trac™ undercarriage that provides greater flotation, sidehill stability and reduced soil compaction.
- LEXION 460 and 480 combines are available with a number of different tire options to fit all applications.
- A powered rear axle is available on all four combines.

SUPER RURAL TRACTORS

- **Cat diesel Engines** with large piston displacement and individual adjustment-free fuel pumps and valves. High drawbar power for all day hard work, season after season.
- **Sealed and Lubricated Track** greatly reduces internal pin and bushing wear for lower undercarriage maintenance costs.
- **Direct drive transmission** helps deliver maximum engine power to the drawbar. Closely spaced speeds match implement requirements.
- **Excellent balance** with weight forward and low center of gravity.
- **Easy maintenance** with spin-on fuel filter, two-piece master link, hydraulic track adjusters. Power train oil dipstick and filler spout are within easy reach from ground level.
- **Variable horsepower arrangements** are available for increased production in high speed tillage operations.



MODEL	Challenger 35		Challenger 45		Challenger 55	
Gross Horsepower	165 kW	221 hp	181 kW	243 hp	213 kW	285 hp
PTO Horsepower	131 kW	175 hp	149 kW	200 hp	168 kW	225 hp
Drawbar Horsepower	112 kW	150 hp	127 kW	170 hp	142 kW	191 hp
Operating Weight Range*	10 047- 12 018 kg	22,150- 26,500 lb	10 070- 12 018 kg	22,200- 26,500 lb	10 070- 12 018 kg	22,200- 26,500 lb
Engine Model	3116		3116		3126	
Rated Engine RPM	2100		2100		2100	
No. of Cylinders/Aspiration	6 ATAAC		6 ATAAC		6 ATAAC	
Bore	105 mm	4.13"	105 mm	4.13"	110 mm	4.33"
Stroke	127 mm	5"	127 mm	5"	127 mm	5"
Displacement	6.6 L	403 in³	6.6 L	403 in³	7.2 L	442 in³
Max. Torque Rise (standard)	68%**		57%**		46%**	
Track Rollers (each side)	3		3		3	
Width of Standard Track Belt▲	457 mm	18"	457 mm	18"	457 mm	18"
Length of Track on Ground	2.18 m	7'2"	2.18 m	7'2"	2.18 m	7'2"
Ground Contact Area (with std. belt)	2 m ²	3096 in²	2 m ²	3096 in²	2 m ²	3096 in²
Grouser Height (std. belt)▼	63.5 mm	2.5"	63.5 mm	2.5"	63.5 mm	2.5"
Track Gauge:						
1.52 m (60") base	1.47 m	60"	1.47 m	60"	1.47 m	60"
2.03 m (80") base	2.03 m	80"	2.03 m	80"	2.03 m	80"
GENERAL DIMENSIONS:						
Wheelbase	2184 mm	7'2"	2184 mm	7'2"	2184 mm	7'2"
Height (to top of ROPS)	3.05 m	10'0"	3.05 m	10'0"	3.05 m	10'0"
Overall Length	5.36 m	17'7"	5.36 m	17'7"	5.36 m	17'7"
Width with Standard Belt:						
1.52 m (60") base	2.31 m	7'7"	2.31 m	7'7"	2.31 m	7'7"
2.03 m (80") base	2.82 m	9'3"	2.82 m	9'3"	2.82 m	9'3"
Ground Clearance	480 mm	18.9"	480 mm	18.9"	480 mm	18.9"
Drawbar Height	508 mm	1'8"	508 mm	1'8"	508 mm	1'8"
Fuel Tank Refill Capacity	322 L	85 U.S. gal	473 L	125 U.S. gal	473 L	125 U.S. gal

*Operating Weight includes lubricants, coolants, standard belt, ROPS cab, full fuel tank and operator.

**Maximum PTO torque rise.

▲ Optional Belt Widths: 457 mm (18"), 508 mm (20"), 624 mm (25"), 762 mm (30"), 813 mm (32").

▼ Heavy Duty 38 mm (1.5") extra wide Grousers available for all belts.

Specifications
● Challenger Tractors

Agricultural Equipment



MODEL	Challenger 65E		Challenger 75E		Challenger 85E		Challenger 95E	
Gross Horsepower	231 kW	310 hp	254 kW	340 hp	280 kW	375 hp	306 kW	410 hp
Power Reserve	9%		8%		7%		10%	
PTO Horsepower	206 kW	277 hp****	224 kW	301 hp****	253 kW	339 hp****	279 kW	375 hp****
Drawbar Horsepower (firm ground)	175 kW	235 hp	198 kW	266 hp	217 kW	291 hp	236 kW	317 hp
Operating Weight*	15 186 kW	33,480 lb	15 186 kg	33,480 lb	15 413 kg	33,980 lb	15 413 kg	33,980 lb
Engine Model	3176C		3176C		3196		3196	
Rated Engine RPM	2100		2100		2100		2100	
No. of Cylinders/Aspiration	6 ATAAC		6 ATAAC		6 ATAAC		6 ATAAC	
Bore	125 mm	4.92"	125 mm	4.92"	130 mm	5.1"	130 mm	5.1"
Stroke	140 mm	5.5"	140 mm	5.5"	150 mm	5.9"	150 mm	5.9"
Displacement	10.3 L	629 in³	10.3 L	629 in³	12.0 L	732 in³	12.0 L	732 in³
Max. Torque Rise (standard)	37%****		41%****		42% in high hp****		43% in high hp****	
Midwheels (each side)	4		4		4		4	
Width of Standard Track Belt**	635 mm	25"	635 mm	25"	635 mm	25"	635 mm	25"
Length of Track on Ground	2.72 m	8'11"	2.72 m	8'11"	2.72 m	8'11"	2.72 m	8'11"
Ground Contact Area (w/std. belt)	3.45 m ²	5355 in²	3.45 m ²	5355 in²	3.45 m ²	5355 in²	3.45 m ²	5355 in²
Grouser Height (std. belt)***	63.5 mm	2.5"	63.5 mm	2.5"	63.5 mm	2.5"	63.5 mm	2.5"
Track Gauge	2.29 m	90"	2.29 m	90"	2.29 m	90"	2.29 m	90"
GENERAL DIMENSIONS:								
Wheel Base	2721 mm	8'11"	2721 mm	8'11"	2721 mm	8'11"	2721 mm	8'11"
Height (to top of ROPS)	3.40 m	11'2"	3.40 m	11'2"	3.40 m	11'2"	3.40 m	11'2"
Overall Length	5.94 m	19'6"	5.94 m	19'6"	5.94 m	19'6"	5.94 m	19'6"
Width with Standard Belt	2.92 m	9'7"	2.92 m	9'7"	2.92 m	9'7"	2.92 m	9'7"
Ground Clearance	394 mm	15.5"	394 mm	15.5"	394 mm	15.5"	394 mm	15.5"
Drawbar Height	457 mm	18"	457 mm	18"	457 mm	18"	457 mm	18"
Fuel Tank Refill Capacity	1060 L	280 U.S. gal	1060 L	280 U.S. gal	1060 L	280 U.S. gal	1060 L	280 U.S. gal

*Operating weight includes lubricants, coolants, standard belt, ROPS cab, full fuel tank and operator.

**Optional belt widths: 635 mm (25") std., 762 mm (30"), 889 mm (35").

***Heavy Duty 38 mm (1.5") extra wide grousers available for all belt widths.

****Measured at University of Nebraska tractor test lab.

MODEL	VFS50				VFS70			
GENERAL DIMENSIONS:								
Track Gauge								
Wide Axle	3175 mm	10'5"	3175 mm	10'5"	3175 mm	10'5"	3175 mm	10'5"
Narrow Axle	2692 mm	8'10"	2692 mm	8'10"	2692 mm	8'10"	2692 mm	8'10"
Hitch and Frame	2260 mm	7'5"	2260 mm	7'5"	2260 mm	7'5"	2260 mm	7'5"
Track Length CL to CL	3023 mm	9'11"	3023 mm	9'11"	3023 mm	9'11"	3023 mm	9'11"
Track Height	940 mm	3'1"	940 mm	3'1"	940 mm	3'1"	940 mm	3'1"
Overall Length	6261 mm	20'7"	6261 mm	20'7"	6261 mm	20'7"	6261 mm	20'7"
Hitch and Frame								
Frame Length	4597 mm	15'1"	4597 mm	15'1"	4597 mm	15'1"	4597 mm	15'1"
Frame Width	864 mm	2'10"	864 mm	2'10"	864 mm	2'10"	864 mm	2'10"
Ground Clearance	462 mm	18"	462 mm	18"	462 mm	18"	462 mm	18"
Hitch Height	368 mm	15"	368 mm	15"	368 mm	15"	368 mm	15"
Hitch to Undercarriage Pivot	4115 mm	13'6"	4115 mm	13'6"	4115 mm	13'6"	4115 mm	13'6"
Front of frame to Undercarriage Pivot	2438 mm	8'0"	2438 mm	8'0"	2438 mm	8'0"	2438 mm	8'0"
Weight								
Undercarriage with Hitch and Frame	4589 kg	10,118 lb	5121 kg	11,290 lb	5121 kg	11,290 lb	5121 kg	11,290 lb
Narrow Axle	3689 kg	8132 lb	4283 kg	9442 lb	4283 kg	9442 lb	4283 kg	9442 lb
Wide Axle	3741 kg	8248 lb	4350 kg	9590 lb	4350 kg	9590 lb	4350 kg	9590 lb
Maximum Gross Weight	27 269 kg	60,118 lb	36 873 kg	81,290 lb	36 873 kg	81,290 lb	36 873 kg	81,290 lb
Travel Speed	up to 32 km/h	up to 20 mph	up to 32 km/h	up to 20 mph	up to 32 km/h	up to 20 mph	up to 32 km/h	up to 20 mph
Axles	6				6			
Oscillation	17 deg up, 17 deg down				17 deg up, 17 deg down			
Belt Tension	2449 kg	5400 lb	2449 kg	5400 lb	2449 kg	5400 lb	2449 kg	5400 lb
Belt Width	762 mm	30"	762 mm	30"	762 mm	30"	762 mm	30"
Crop Clearance	439 mm	17.3"	439 mm	17.3"	439 mm	17.3"	439 mm	17.3"

VFS GROUND PRESSURE

		VFS Weight with Load															
		9072 kg 20,000 lb		13 608 kg 30,000 lb		18 144 kg 40,000 lb		22 680 kg 50,000 lb		27 216 kg 60,000 lb		31 750 kg 70,000 lb					
Belt Width		Contact Area		Ground pressure													
mm	in	m ²	in ²	kPa	psi	kPa	psi	kPa	psi	kPa	psi	kPa	psi	kPa	psi	kPa	psi
762	30	4.61	7140	19.3	2.8	28.9	4.2	38.6	5.6	48.2	7.0	57.9	8.4	67.5	9.8		



MODEL	LEXION 460/465		LEXION 480/485	
PRE-SEPARATION:				
Type	APS system		APS system	
THRESHING:				
Cylinder diameter	600 mm	23.5"	600 mm	23.5"
Cylinder width	1700 mm	5'7"	1700 mm	5'7"
Speed	362 to 1050 rpm		362 to 1050 rpm	
Single range	158 to 457 rpm		158 to 457 rpm	
Dual range (low)	362 to 1050 rpm		362 to 1050 rpm	
Dual range (high)	Bar and wire		Bar and wire	
Concave type				
Concave area	0.64 m ² 993 in ²		0.64 m ² 993 in ²	
Pre-concave	1.29 m ² 1992 in ²		1.29 m ² 1992 in ²	
Main concave	0.32 m ² 501 in ²		NA	
Concave grate extension	2.25 m ² 3486 in ²		1.93 m ² 2985 in ²	
Total concave area				
Concave adjustment	Electric over hydraulic		Electric over hydraulic	
Concave overload protection	Hydraulic		Hydraulic	
Dump rock trap	Yes		Yes	
SEPARATION:				
Straw walkers				
Number of straw walkers	6		NA	
Length	4367 mm	14'4"	NA	NA
Crank shaft throw	100 mm	3.9"	NA	NA
Separation area				
Straw walkers	7.42 m ²	11,507 in ²	NA	NA
With intensive separation	9.85 m ²	15,520 in ²	NA	NA
Rotary				
Number of rotors	NA		2	
Diameter	NA		444 mm	17.5"
Length	NA		4200 mm	13'9"
Separation area	NA		6.34 m ²	9826 in ²
CLEANING SYSTEM:				
Total cleaning area	5.99 m ²	9286 in ²	5.99 m ²	9286 in ²
Cleaning fan	6 turbine fans		6 turbine fans	
Electric sieve adjustment	Optional		Optional	
3-D sieve	Optional		Optional	
ENGINE:				
Caterpillar	3126 ATAAC		3176C ATAAC	
Number of cylinders	6		6	
Displacement	7.2 L	439 in ³	10.3 L	629 in ³
Rated speed	2100 rpm		2100 rpm	
Horsepower	216 kW	290 hp	272 kW	365 hp
Transmission				
Type	Hydrostatic		Hydrostatic	
	variable 3-speed		variable 3-speed	
DIMENSIONS/CAPACITIES:				
Fuel tank	650 L	170 U.S. gal	650 L	170 U.S. gal
Unloading speed	89 L/sec	2.5 bu/sec	89 L/sec	2.5 bu/sec
Chassis length	8.83 m 29'0"		8.83 m 29'0"	
Transport width	460: 3.57 m	11'9"	480: 3.57 m	11'9"
	465: 4.25 m	13'11.5"	485: 4.25 m	13'11.5"
Transport height	3.99 m 13'1"		3.99 m 13'1"	
Weight	460: 13 381 kg	29,500 lb	480: 14 515 kg	32,000 lb
	465: 16 874 kg	37,200 lb	485: 18 008 kg	39,700 lb
CAB INSTRUMENTATION:				
Sound level	76 dB(A)		76 dB(A)	
On-board computer system	IMO std., CEBIS optional		IMO std., CEBIS optional	
Yield monitor	Optional		Optional	
GPS yield mapping	Optional		Optional	
TRACKS/WHEELS:				
Mobil-trac system				
Front tires				
Rear tires				
HEADERS				
	465 and 485 — with 893 mm (35") Caterpillar belts			
	460 and 480 — Variety of sizes and tread types			
	Variety of sizes and treads; optional power rear axle available			
	Corn, 762 mm (30") row spacing — 6, 8 and 12 row;			
	Rigid, 7.6 m (25'0") and 9.1 m (30'0"); Flexible, 7.6 m (25'0") and 9.1 m (30'0");			
	Pickup, 4 m (13'0")			

*With 20.8R-42 tires.



MODEL	D4E SR		D6G SR	
Flywheel Power*	93 kW	125 hp	161 kW	216 hp
Operating Weight**	9400 kg	20,730 lb	14 960 kg	32,987 lb
Engine Model	3304		3306	
Rated Engine RPM	2200		1900	
No. of Cylinders	4		6	
Bore	121 mm	4.75"	121 mm	4.75"
Stroke	152 mm	6"	152 mm	6"
Displacement	7 L	425 in³	10.5 L	638 in³
Max. Torque Rise (standard)	30%		24%	
(variable horsepower)	30%		21%	
Track Rollers (each side)	5		7	
Width of Standard Track Shoe	406 mm	16"	508 mm	1'8"
Length of Track on Ground	1.89 m	6'2"	2.667 m	8'9"
Ground Contact Area (with std. shoe)	1.53 m ²	2380 in²	2.72 m ²	4212 in²
Grouser Height	48 mm	1.88"	—	—
Track Gauge	1.52 m	5'0"	1.88 m	6'2"
GENERAL DIMENSIONS:				
Height (without ROPS or exhaust)	1.93 m	6'4"	2.03 m	6'8"
Height (to top of ROPS)	2.71 m	8'11"	3.06 m	10'0"
Overall Length	3.37 m	11'0"	3.73 m	12'3"
Width with Standard Shoe	1.98 m	6'6"	—	—
Ground Clearance	360 mm	14"	310 mm	12.2"
Fuel Tank Refill Capacity	295 L	78 U.S. gal	435 L	115 U.S. gal

*For variable horsepower ratings see the power ratings on adjacent page.

****Operating Weight** includes lubricants, coolants, standard track shoes, ROPS canopy, full fuel tank and operator.

HORSEPOWER RATINGS

MODEL	Gross		Drawbar** Concrete		Drawbar* Firm Soil		PTO	
	kW	hp	kW	hp	kW	hp	kW	hp
Challenger 35	165	221	137	185	112	150	131	175
Challenger 45	181	243	158	211	127	170	149	200
Challenger 55	213	285	176	236	142	191	168	225
Challenger 65E	231	310	207	** 278	175	235	207	** 277
Challenger 75E	254	340	220	** 295	198	266	224	** 301

VARIABLE HORSEPOWER RATINGS

MODEL	Gross		Drawbar Concrete		Drawbar Firm Soil		PTO	
	kW	hp	kW	hp	kW	hp	kW	hp
D4E SR VHP								
Gears 1-2	66	89	59	80	47	64	—	—
Gears 3-5	103	138	92	125	76	104	—	—
D6G SR VHP								
Gears 1-2-6	128	172	116	155	162	121	—	—
Gears 3-4-5	174	234	162	216	228	170	—	—
Challenger 85E								
Gears 1-2	254	340	208	** 279	—	—	226	303
Gears 3-10	280	375	244	** 327	217	291	253	339
Challenger 95E								
Gears 1-2	254	340	213	** 285	—	—	227	305
Gear 3	280	375	244	** 327	—	—	253	339
Gears 4-10	306	410	272	** 365	236	317	280	375

*Estimated drawbar power based on firm soil conditions with standard machine configuration.

**University of Nebraska Tractor Test Lab results.

TRAVEL SPEEDS

TRAVEL SPEEDS

MODEL	Challenger 35		Challenger 45		Challenger 55		MODEL	D4E SR VHP		D6G SR VHP	
GEAR	km/h	mph	km/h	mph	km/h	mph	FORWARD	km/h	mph	km/h	mph
1	2.62	1.6	2.62	1.6	2.62	1.6	GEAR*				
2	3.11	1.9	3.11	1.9	3.11	1.9	1	3.2	2.0	3.0	1.9
3	3.64	2.3	3.64	2.3	3.64	2.3	2	4.6	2.9	4.3	2.7
4	4.17	2.6	4.17	2.6	4.17	2.6	3	5.6	3.5	5.8	3.6
5	4.93	3.1	4.93	3.1	4.93	3.1	4	6.4	4.0	6.8	4.3
6	5.76	3.6	5.76	3.6	5.76	3.6	5	7.2	4.5	7.7	4.8
7	6.79	4.2	6.79	4.2	6.79	4.2	6	—		9.3	5.8
8	8.02	5.0	8.02	5.0	8.02	5.0					
9	9.39	5.8	9.39	5.8	9.39	5.8	REVERSE				
10	11.11	6.9	11.11	6.9	11.11	6.9	GEAR				
11	12.70	7.9	12.70	7.9	12.70	7.9	1	3.8	2.4	4.1	2.5
12	15.04	9.3	15.04	9.3	15.04	9.3	2	5.4	3.4	5.8	3.6
13	17.60	10.9	17.60	10.9	17.60	10.9	3	6.6	4.1	7.9	4.9
14	20.70	12.9	20.70	12.9	20.70	12.9	4	7.5	4.7	9.1	5.7
15	24.49	15.2	24.49	15.2	24.49	15.2	5	8.6	5.3	10.5	6.6
16	28.64	17.8	28.64	17.8	28.64	17.8	6	—		—	

TRAVEL SPEEDS

MODEL	Challenger 65E		Challenger 75E		Challenger 85E		Challenger 95E	
FORWARD	km/h	mph	km/h	mph	km/h	mph	km/h	mph
GEAR								
1	4.3	2.7	4.5	2.8	4.5	2.8	4.5	2.8
2	6.4	4.0	6.4	4.0	6.4	4.0	6.4	4.0
3	7.6	4.7	7.9	4.9	7.9	4.9	7.9	4.9
4	8.7	5.4	9.0	5.6	9.0	5.6	9.0	5.6
5	10.0	6.2	10.3	6.4	10.3	6.4	10.3	6.4
6	11.3	7.0	11.3	7.0	11.3	7.0	11.3	7.0
7	12.9	8.0	12.9	8.0	12.9	8.0	12.9	8.0
8	14.8	9.2	14.8	9.2	14.8	9.2	14.8	9.2
9	19.3	12.0	20.1	12.5	20.1	12.5	20.1	12.5
10	29.0	18.0	29.0	18.0	29.0	18.0	29.0	18.0
REVERSE								
GEAR								
1	3.2	2.0	3.2	2.0	3.2	2.0	3.2	2.0
2	7.3	4.5	7.6	4.7	7.6	4.7	7.6	4.7

DRAWBAR PULL FORWARD*

DRAWBAR PULL

GEAR	Challenger 35			Challenger 45			Challenger 55			MODEL FORWARD GEAR	D4E SR VHP			D6G SR VHP		
	kN	kg	lb	kN	kg	lb	kN	kg	lb		kN	kg	lb	kN	kg	lb
1	84.4	8604	18,968	85.1	8675	19,125	85.1	8675	19,125							
2	83.4	8499	18,737	85.1	8675	19,125	85.1	8675	19,125	1	53.4	5450	12,012	110	11 308	24,878
3	81.6	8314	18,329	85.1	8675	19,125	85.1	8675	19,125	2	36.7	3744	8252	77	7771	17,097
4	77.0	7851	17,307	81.0	8255	18,199	85.1	8675	19,125	3	49.7	5068	11,170	79	8130	17,887
5	70.3	7161	15,787	75.6	7710	16,997	81.0	8255	18,200	4	43.2	4408	9715	67	6866	15,105
6	65.7	6694	14,757	71.8	7318	16,134	76.5	7802	17,200	5	37.5	3832	8448	58	5926	13,037
7	58.4	5949	13,116	66.3	6757	14,897	70.5	7188	15,848	6	—	—	—	31	3135	6987
8	50.5	5147	11,348	57.8	5891	12,987	64.7	6593	14,535							
9	43.5	4436	9779	49.7	5063	11,162	55.6	5663	12,484							
10	36.7	3740	8244	40.9	4170	9193	45.9	4676	10,310							
11	31.1	3171	6991	34.8	3547	7821	39.1	3990	8796	1						
12	25.5	2601	5735	28.7	2920	6438	32.3	3295	7264	2	57.5	5868	12,933	144	14 770	32,496
13	21.1	2154	4749	23.8	2427	5351	26.9	2747	6056	3	50.5	5148	11,349	100	10 221	22,487
14	17.4	1771	3904	19.7	2003	4416	22.3	2275	5015	4	57.2	5831	12,859	100	10 190	22,420
15	14.2	1449	3194	16.1	1646	3629	18.4	1876	4135	5	48.1	5002	11,207	84	8634	18,996
16	11.7	1196	2637	13.4	1365	3010	15.3	1562	3443	6	43.5	4433	9773	73	7477	16,450
											—	—	—	42	4258	9368

**DRAWBAR PULL FORWARD
 Ballasted @ Max. Power**

GEAR	Challenger 35			Challenger 45			Challenger 55		
	kN	kg	lb	kN	kg	lb	kN	kg	lb
1	122.5	12 503	27,540	125.19	12 780	28,150	129.24	13 193	29,060
2	122.42	12 494	27,520	126.02	12 862	28,330	130.64	13 334	29,370
3	121.17	12 367	27,240	121.7	12 421	27,360	131.21	13 393	29,500
4	118.89	12 135	26,730	124.95	12 753	28,090	130.82	13 352	29,410
5	118.14	12 058	26,560	122.17	12 471	27,470	129.27	13 193	29,060
6	100.52	10 260	22,600	116.48	11 890	26,190	114.38	11 672	25,710
7	85.89	8767	19,310	94.68	9666	21,290	97.89	9993	22,010
8	74.34	7586	16,710	85.87	8762	19,300	83.5	8522	18,770
9	62.37	6365	14,020	72.09	7359	16,210	70.57	7205	15,870
10	51.52	5257	11,580	59.55	6079	13,390	58.18	5938	13,080
11	43.5	4440	9779	50.2	5191	11,435	53.5	5463	12,034
12	36.7	3743	8244	42.6	4407	9708	45.5	4644	10,229
13	31.1	3174	6991	35.49	3673	8090	38.2	3901	8592
14	25.5	2604	5735	29.3	3030	6674	32.1	3277	7217
15	21.1	2156	4749	24.2	2500	5506	26.9	2752	6062
16	17.4	1772	3904	19.8	2050	4515	22.3	2284	5031

*Specified pull is based on nominal engine performance derated for transmission lube, control and optional implement hydraulic pumps, with corrections made for drive-line mechanical efficiency and rolling resistance on firm level ground. Usable pull will depend on particular attachments, and weight and traction of equipped tractor.

DRAWBAR PULL FORWARD*

MODEL	Challenger 65E			Challenger 75E			Challenger 85E			Challenger 95E		
FORWARD GEAR	At Rated RPM			At Rated RPM			At Rated RPM			At Rated RPM		
	kN	kg	lb	kN	kg	lb	kN	kg	lb	kN	kg	lb
1	148.05	15 098	33,284	148.80	15 174	33,452	151.55	15 454	34,070	156.59	15 968	35,202
2	105.99	10 808	23,827	114.70	11 696	25,785	113.52	11 576	25,520	112.83	11 506	25,366
3	90.85	9265	20,425	92.20	9402	20,728	103.61	10 566	23,294	103.02	10 505	23,159
4	79.39	8096	17,849	79.97	8155	17,979	90.00	9177	20,232	98.90	10 085	22,234
5	68.29	6964	15,352	68.80	7015	15,466	78.42	7997	17,629	85.60	8729	19,244
6	59.01	6017	13,265	62.87	6412	14,135	71.27	7268	16,022	77.50	7903	17,423
7	51.45	5247	11,567	54.36	5543	12,221	62.01	6323	13,940	67.32	6865	15,134
8	43.83	4469	9853	47.05	4798	10,578	53.12	5417	11,942	57.87	5901	13,009
9**	33.31	3396	7488	34.35	3502	7722	38.78	3954	8718	42.22	4308	9497
10**	22.35	2279	5025	23.99	2447	5395	38.78	2763	6090	29.51	3010	6635
	At Max. Power			At Max. Power			At Max. Power			At Max. Power		
1	147.22	15 012	33,096	148.12	15 104	33,299	150.15	15 312	33,756	156.20	15 928	35,115
2	130.29	13 286	29,291	131.88	13 448	29,648	136.79	13 949	30,751	138.40	14 113	31,113
3	111.96	11 417	25,169	112.65	11 487	25,325	126.11	12 860	28,351	127.39	12 991	28,639
4	97.46	9938	21,910	98.26	11 020	22,089	109.95	11 212	24,718	122.54	12 496	27,548
5	85.29	8698	19,175	86.51	8822	19,448	95.59	9747	21,489	106.29	10 839	23,896
6	73.67	7513	16,562	78.47	8002	17,641	86.69	8840	19,488	96.21	9811	21,629
7	64.44	6572	14,488	68.15	6949	15,320	75.75	7724	17,029	83.96	8561	18,874
8	55.34	5644	12,442	59.12	6029	13,292	64.97	6625	14,605	73.11	7455	16,436
9**	42.06	4289	9456	43.16	4401	9703	47.43	4836	10,662	53.37	5442	11,998
10**	28.22	2878	6345	30.15	3075	6779	33.13	3379	7449	32.29	3802	8382

*Numbers from Nebraska test on concrete.

**Tests were not conducted in these gear settings, data is estimated.

Row-Crop

Gauge (Track) Spacing	Spacer Quantity (per side)	Spacer Size
1524 mm (60") Base Tractor	No spacers	
1575 mm (62")	1	25.4 mm (1") [max. belt width 457 mm (18")]
1626 mm (64")	1	50.8 mm (2") [max. belt width 508 mm (1'8")]
1676 mm (66")	1	76.2 mm (3") [max. belt width 508 mm (1'8")]
1727 mm (68")	1	101.6 mm (4") [max. belt width 635 mm (2'1")]
1778 mm (70")	1 plus	101.6 mm (4") [max. belt width 635 mm (2'1")]
1829 mm (72")	1	25.4 mm (1")
1829 mm (72")	1	152.4 mm (6") [max. belt width 635 mm (2'1")]
1880 mm (74")	1 plus	152.4 mm (6")
1930 mm (76")	1	25.4 mm (1")
1930 mm (76")	1	203.2 mm (8")
1981 mm (78")	1 plus	203.2 mm (8")
1981 mm (78")	1	25.4 mm (1")
2032 mm (80")	1	254 mm (10")
2083 mm (82")	1 plus	254 mm (10")
2083 mm (82")	1	25.4 mm (1")
2134 mm (84")	1 plus	254 mm (10")
2134 mm (84")	1	50.8 mm (2")
2184 mm (86")	1 plus	254 mm (10")
2184 mm (86")	1	76.2 mm (3")
2235 mm (88")	1	355.6 mm (14")
2286 mm (90")	1 plus	355.6 mm (14")
2286 mm (90")	1	25.4 mm (1")

Gauge (Track) Spacing	Spacer Quantity (per side)	Spacer Size
2032 mm (80") Base Tractor	No spacers	
2083 mm (82")	1	25.4 mm (1")
2134 mm (84")	1	50.8 mm (2")
2184 mm (86")	1	76.2 mm (3")
2235 mm (88")	1	101.6 mm (4")
2286 mm (90")	1 plus	101.6 mm (4")
2286 mm (90")	1	25.4 mm (1")
2337 mm (92")	1	152.4 mm (6")
2389 mm (94")	1 plus	152.4 mm (6")
2389 mm (94")	1	25.4 mm (1")
2438 mm (96")	1	203.2 mm (8")
2489 mm (98")	1 plus	203.2 mm (8")
2489 mm (98")	1	25.4 mm (1")
2540 mm (100")	1	254 mm (10")
2591 mm (102")	1 plus	254 mm (10")
2591 mm (102")	1	25.4 mm (1")
2642 mm (104")	1 plus	254 mm (10")
2642 mm (104")	1	50.8 mm (2")
2692 mm (106")	1 plus	254 mm (10")
2692 mm (106")	1	76.2 mm (3")
2743 mm (108")	1	355.6 mm (14")
2794 mm (110")	1 plus	355.6 mm (14")
2845 mm (112")	1 plus	355.6 mm (14")
2845 mm (112")	1	50.8 mm (2")
2896 mm (114")	1 plus	355.6 mm (14")
2896 mm (114")	1	76.2 mm (3")
2946 mm (116")	1 plus	355.6 mm (14")
2946 mm (116")	1	101.6 mm (4")
2997 mm (118")	1 plus	355.6 mm (14")
2997 mm (118")	1 plus	25.4 mm (1")
2997 mm (118")	1	101.6 mm (4")
3048 mm (120")	1	508 mm (1'8")

NOTE: The chart reflects the recommended spacer combinations, although others are possible.

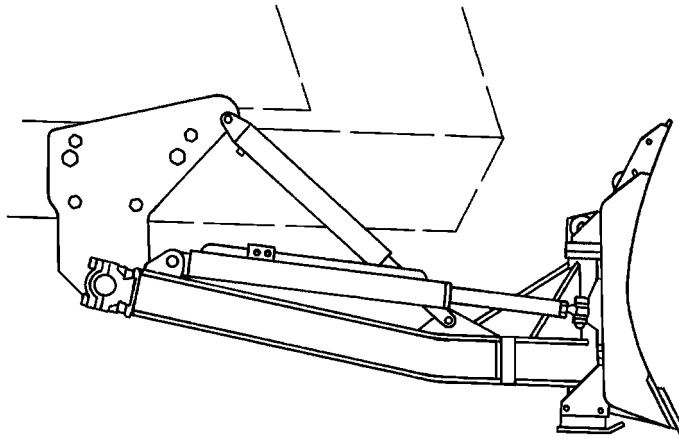

**Balderson Blades Specifications
Challenger 65E, 75E, 85E, 95E**

Model	B95/65A-14P		B95/65A-12'6P		B95/65A-12'6		B95/65A-12P		B95/65A-12	
Challenger Track Width	889 mm	2'11"	762 mm	2'6"	762 mm	2'6"	624 mm	2'1"	624 mm	2'1"
Capacity	4.8 m ³	5.3 yd³	4.3 m ³	4.7 yd³	4.3 m ³	4.7 yd³	4.1 m ³	4.5 yd³	4.1 m ³	4.5 yd³
Blade Type	PAT		PAT		Hyd. Angle		PAT		Hyd. Angle	
Width — Straight	4216 mm	13'10"	3785 mm	12'5"	3785 mm	12'5"	3683 mm	12'1"	3683 mm	12'1"
Width — Angled	3810 mm	12'6"	3429 mm	11'3"	3424 mm	11'3"	3277 mm	10'9"	3277 mm	10'9"
Height	1118 mm	3'8"	1118 mm	3'8"	1118 mm	3'8"	1118 mm	3'8"	1118 mm	3'8"
Max. Dig Depth	610 mm	2'0"	610 mm	2'0"	610 mm	2'0"	610 mm	2'0"	610 mm	2'0"
Max. Height	762 mm	2'6"	762 mm	2'6"	762 mm	2'6"	762 mm	2'6"	762 mm	2'6"
Blade Angle (degrees)	25		25		25		25		25	
Weight (approx.)	1800 kg	3970 lbs	1720 kg	3790 lbs	1720 kg	3790 lbs	1542 kg	3400 lbs	1490 kg	3280 lbs

DRAWBAR POWER AND TILLAGE

Tillage work ability, or rate, is measurable in drawbar power, either kilowatts or horsepower. If the quantity of work done is being emphasized, then a unit of time is also included. The common terminology is Kilowatt hours or horsepower hours.

Work rate is a combination of *load* (or force) times *distance*, divided by *time* or simply *load* times *speed*. For example a 5000 kg (11,000 lb) load pulled at 5 km/h (3.1 mph) is equivalent work to a 2000 kg (4400 lb) load pulled at 12.5 km/h (7.8 mph).

A Pullmeter is used most frequently to measure implement loads. The Towner Pullmeter is a hydraulic cylinder with a head machined precisely to 10 square inches. Gauges are used to read pounds per square inch thus 10 times the gauge reading gives drawbar pounds pull (DBPP) in thousands of pounds exerted by the implement pulled. Similar pullmeters are available with gauges reading in Kilograms pull.

Formulas providing either Metric or English units of work rate are:

Metric:

$$\text{Drawbar Kilowatts (DBkW)} = \frac{\text{kg Drawbar pull} \times \text{km/h}}{367}$$

$$\text{Drawbar Power} = \frac{\text{kg Drawbar pull} \times \text{km/h}}{274}$$

English:

$$\text{Drawbar Horsepower} = \frac{\text{lb Drawbar pull} \times \text{mph}}{375}$$

Example (Metric)

A 6 m implement imposes 5000 kg draft at 5 km/h requires how many drawbar kilowatts to pull it?

$$\text{Solution: } \frac{5000 \text{ kg} \times 5 \text{ km/h}}{367} = 68.1 \text{ DBkW}$$



Example (English)

A 20 ft wide implement imposing 11,000 DBPP at 3 mph requires how many drawbar horsepower to pull it?

$$\text{Solution: } \frac{11,000 \text{ DBPP} \times 3.0 \text{ mph}}{375} = 88.0 \text{ DBHP}$$



TILLAGE PRODUCTION

Tillage production is most commonly measured in area covered per hour, i.e. hectares per hour or acres per hour. Production can be determined by field measurement of tractor speed and implement width. If implement width is known and drawbar pull can be estimated, reference to tractor drawbar pull/speed graphs will give estimated speeds for each gear, and use of standard formulas will provide reasonable estimates of tillage production. Drawbar pull is a function of: 1) speed of tractor, 2) implement width and, 3) tillage depth.

Formulas

A. At 100% efficiency (not attainable)

Metric:

$$\text{Hectares/hr} = \frac{\text{Width (m)} \times \text{Speed (km/h)}}{10}$$

English:

$$\text{Acres/hr} = \frac{\text{Width (ft)} \times \text{Speed (mph)}}{8.25}$$

B. At 82.5% efficiency (average for tillage — includes turns)

Metric:

$$\text{Hectares/hr} = \text{meters} \times \text{km/h} \times 0.0825$$

English:

$$\text{Acres/hr} = \frac{\text{feet} \times \text{mph}}{10}$$

Example problem

Calculate normal tillage production of a D6E SR with a 6 m (20 ft) cut width disc plowing harrow pulled at a measured speed of 6 km/h (3.7 mph).

Solution:

Hectares/hr

$$= 6 \text{ m} \times 6 \text{ km/h} \times 0.0825 = 3 \text{ Hectares/hr}$$

$$\text{Acres/hr} = \frac{20 \text{ ft} \times 3.7 \text{ mph}}{10} = 7.4 \text{ Acres/hr}$$



ESTIMATED DRAFT OR DRAWBAR PULL REQUIRED PER M (FT) OF IMPLEMENT WIDTH OF CUT

	Speed	Depth	Soil Type				
			Heavy Gumbo Clay Loam	Moderate Heavy Silty Clay Loam	Average Silty Loam	Moderate Light Sandy Loam	Light Sandy or Coarse
Moldboard plow	5.6-9.6 km/h 3.5-6 mph	178-229 mm 7-9"	1860-2382 kg 1250-1600 lb	1414-1713 kg 950-1150 lb	1115-1266 kg 750-850 lb	745-968 kg 500-650 lb	522-669 kg 350-480 lb
Heavy disc plow 965 mm (3'2")	4.8-8.0 km/h 3-5 mph	254-457 mm 10-18"	2677 kg 1800 lb	2382 kg 1600 lb	2083 kg 1400 lb	1489 kg 1000 lb	1489 kg 1000 lb
1270 mm (4'2")	3.7-6.4 km/h 2.3-4 mph	203-305 mm 8-12"	3573 kg 2400 lb	3274 kg 2200 lb	2976 kg 2000 lb	2677 kg 1800 lb	2382 kg 1600 lb
Heavy offset disc harrow 915 mm (3'0") (stubble or breaking)	4.8-8.0 km/h 3-5 mph	102-203 mm 4-8"	1785 kg 1200 lb	1637 kg 1100 lb	1489 kg 1000 lb	1339 kg 900 lb	1191 kg 800 lb
Heavy tandem or med. offset disc harrow 660-813 mm (2'2"-2'8")	4.8-9.6 km/h 3-6 mph	102-203 mm 4-8"	1191 kg 800 lb	1043 kg 700 lb	892 kg 600 lb	775 kg 500 lb	594 kg 400 lb
Finishing or seedbed disc harrow 508-610 mm (1'8"-2'0")	6.4-11.2 km/h 4-7 mph	51-102 mm 2-4"	446 kg 300 lb	410 kg 275 lb	335 kg 225 lb	335 kg 225 lb	148 kg 100 lb
Disc plow (stubble mulch)	6.4-9.6 km/h 4-6 mph	76-152 mm 3-6"	558 kg 375 lb	482 kg 324 lb	410 kg 275 lb	335 kg 225 lb	259 kg 175 lb
Chisel plow	5.6-10.5 km/h 3.5-6.5 mph	203-305 mm 8-12"	1191 kg 800 lb	968 kg 650 lb	775 kg 500 lb	522 kg 350 lb	299 kg 200 lb
Field cultivation or springtooth	6.4-11.2 km/h 4-7 mph	76-102 mm 3-4"	775 kg 500 lb	558 kg 375 lb	371 kg 250 lb	299 kg 200 lb	223 kg 150 lb
Rod weeder (add to FC or springtooth)	6.4-11.2 km/h 4-7 mph	76-102 mm 3-4"	177 kg 120 lb	157 kg 105 lb	135 kg 90 lb	112 kg 75 lb	89 kg 60 lb

Adjust estimates of varying moisture content.
Use a pullmeter for more accurate measurements.

	Draft or DBPP/Shank							
	Depth		Heavy		Medium		Light	
Lister			363 kg	800 lb	272 kg	600 lb	181 kg	400 lb
V. chisel (parabolic shank)	406 mm	16"	1162 kg	2560 lb	871 kg	1920 lb	653 kg	1440 lb
	457 mm	18"	1306 kg	2880 lb	980 kg	2160 lb	735 kg	1620 lb
	508 mm	1'8"	1452 kg	3200 lb	1089 kg	2400 lb	816 kg	1800 lb
Subsoilers	559 mm	1'10"	1597 kg	3520 lb	1198 kg	2640 lb	898 kg	1980 lb
	508 mm	1'8"	1633 kg	3600 lb	1270 kg	2800 lb	907 kg	2000 lb
	559 mm	1'10"	1814 kg	4000 lb	1406 kg	3100 lb	998 kg	2200 lb
	610 mm	2'0"	1950 kg	4300 lb	1542 kg	3400 lb	1089 kg	2400 lb
	660 mm	2'2"	2132 kg	4700 lb	1633 kg	3600 lb	1179 kg	2600 lb

CONTENTS

Features	3-1
Specifications: Standard Versions	3-4
Specifications: NA Versions	3-6
Specifications: Global Versions	3-8
Specifications: ES Versions	3-9
Travel speeds	3-10
All Wheel Drive (AWD)	3-10
Front Mounted Scarifiers	3-10
Rippers/Scarifiers	3-11
Special attachments	3-12

Features, H-Series Motor Graders:

- **Geographic Versions** — The H-Series was specifically designed to meet the needs of different geographic regions. NA, Standard, ES and Global Versions are available with an assortment of standard features and optional equipment. All motor graders feature advanced Caterpillar engines, power train components, hydraulics and machine structures. The 24H was designed to meet the productivity and durability expectations of Caterpillar mining customers.
- **Power to the Ground** — Proven Caterpillar designed and manufactured components are carefully matched to maximize productivity and efficiency. Caterpillar H-Series engines have excellent lugging performance and fuel economy. Variable Horsepower (VHP) (NA Versions only — standard on models 143H and 163H, optional on models 120H, 135H, 140H and 160H) provides more power in gears 4F-8F and 3R-6R to increase productivity and improve gradeability when roading. Engine Power Management (standard on all ES and Standard Versions) delivers full rated power in gears 4F-8F and 3R-6R. In lower gears, where traction is limited, engine horsepower is automatically reduced, lowering fuel consumption and reducing tire slippage. All models have Caterpillar transmissions that provide on-the-go, full-power shifting and inching capability. Auto-shift is standard equipment on the 24H and optional on certain NA and ES models. In addition, the 24H is equipped with a lockup clutch torque converter which allows the machine to operate in direct drive at high output speeds.
- **Blade Positioning** — The H-Series provides a broad range of extended blade positions particularly beneficial in mid-range bank sloping, ditch cutting and ditch cleaning. A long wheel base allows for an aggressive blade angle permitting material to roll more freely, reducing power requirements.

- **Brakes** — Caterpillar designs and builds multi-disc brakes that are completely sealed, oil-bathed, adjustment-free and offer unmatched reliability and durability. They are located at each tandem wheel to eliminate braking loads on the power train and to speed up servicing. The large brake surface provides dependable braking capability and long life. The 24H brakes are oil-actuated and all other models are air-actuated.
- **Visibility** — Ample glass area and carefully placed components provide excellent visibility to enhance operator confidence and productivity in all motor grader applications. The H-Series gives the operator an exceptional view forward to the blade toe, working surface and front tires. Rearward visibility to the ripper and tandem tires and sideways to the blade heel and front tandem tires is maximized. The slanted rear window and optional sunshade reduce glare.
- **Controllability** — The H-Series features motor grader-specific hydraulic controls providing smooth, predictable response every time a lever is moved. The machines can perform multiple, hydraulic-control operations with little effect on the engine or implement speeds. The result is more production in almost any application. The Proportional, Priority, Pressure-Compensated (PPPC) Hydraulic System is load-sensing and provides hydraulic power on demand, consuming horsepower only when needed. The system provides proportionate flow to each circuit when the system demand exceeds the available flow. Lock valves, built into all control valves, maintain exact cylinder positioning. The implement valves provide superior modulation, system response and predictability.
- **Operator Comfort** — The H-Series provides a comfortable environment to keep the operator alert and focused. Conveniently located, low-effort controls reduce fatigue. The interior noise level is maintained between 75 and 80 dBA with the doors and windows closed. Other standard and optional operator-comfort features may include (availability dependent on model):
 - key engine start-stop switch
 - pressurized cab
 - air conditioning and heating
 - fully adjustable Caterpillar Contour Series Seat
 - adjustable steering and implement control console
 - easy-to-see gauges
 - provisions for entertainment and communication radios
 - lunch box location
 - coat hook
 - sweepout cab floor
 - suspended pedals
 - cigarette lighter and ashtray
 - cupholder
 - 12 volt power port
 - lower-opening front windows
 - sliding side windows
- **Environmental Design** — The H-Series responds to important environmental concerns such as noise and air pollution. Designed with low exterior sound levels and low-emissions engines (except on Standard Version models 12H, 140H and 160H), Caterpillar motor graders are quiet and clean. Low exterior sound levels range from 80 to 84 dBA due to slower engine speeds, underhood mufflers, rubber-mounted engines, transmissions and slower fans. R134a refrigerant is used in the air conditioner. To minimize oil leaks and withstand high working pressures and temperatures, Caterpillar designed, heavy-duty XT hose and O-ring face seals are used.

- **Serviceability** — H-Series motor graders are designed for fast, easy servicing. Easy access to service areas allows for quick maintenance and ensures that routine service is performed on time. Features promoting easy servicing include:
 - Electronic Monitoring System (EMS) to alert the operator to potential problems (EMSII on the 24H)
 - easily replaceable wear inserts to keep the drawbar, circle and blade tight and prevent damage to expensive components
 - large, hinged, engine side doors to provide ample access to the engine and transmission service points (optional on Standard Versions)
 - air cleaner located above the engine, accessible from left side
 - hydraulic oil level sight gauge
 - tandem oil level sight gauge (24H)
 - oil sampling capability from engine and hydraulics
 - oil sampling capability from tandem and power train systems (24H)
 - clustered lube points located at the bolster, drawbar, articulation joint and ripper for ground-level service (24H)
 - auto-lube option available (24H)
 - diagnostic connectors for Electronic Technician (ET) (excluding 14H and 16H)
 - modular wiring harness
 - engine disconnect switch
 - fuse panel located inside the cab
- **143H and 163H All Wheel Drive Motor Graders** — All Wheel Drive (AWD) improves tractive performance in poor underfoot conditions such as snow, mud and sand. This feature also provides excellent steering and sidedraft control. AWD is available in gears 1F-7F and 1R-5R, making it effective in both low-speed and high-speed applications. VHP is standard on AWD models and delivers maximum power in all gears when AWD is engaged. Three operating modes are available: automatic, manual or off.
- **24H Motor Grader** — To meet the specialized needs of Caterpillar's large mining customers, the 24H is sized to maintain haul roads for large mining-truck fleets. The Caterpillar 3412E Hydraulic Electronic Unit Injector (HEUI) engine, power train components and machine structures are designed to meet the rigors of this application.
- **Best Product Support** — Caterpillar motor grader users are assured the best product support anywhere in the world. With industry-best parts availability, training and an offering of inspection, maintenance and repair, Caterpillar dealers can provide the support needed to keep the machines productive.

Motor Graders Standard Versions

Specifications



MODEL	120H		135H		12H	
Net Flywheel Power: Gears 4-8	104 kW	140 hp	116 kW	155 hp	104 kW	140 hp
Gears 1-3▲	93 kW	125 hp	101 kW	135 hp	104 kW	140 hp
Operating Weight*	11 358 kg	25,040 lb	11 788 kg	25,990 lb	13 077 kg	28,830 lb
Engine Model	3116 DITA		3116 DITA		3306 DINA	
Rated Engine RPM	2000		2000		2000	
No. of Cylinders	6		6		6	
Displacement	6.6 L	403 in³	6.6 L	403 in³	10.45 L	638 in³
Max. Torque Rise	30%		30%		30.5%	
No. of Speeds Forward/Reverse	8/6		8/6		8/6	
Top Speed Forward	42.6 km/h	26.5 mph	41.9 km/h	26.0 mph	41.7 km/h	25.9 mph
Reverse	33.7 km/h	20.9 mph	33.1 km/h	20.6 mph	32.9 km/h	20.4 mph
Std. Tires — Front & Rear	13.00-24 (10 PR) (G-2)		13.00-24 (10 PR) (G-2)		13.00-24 (10 PR) (G-2)	
Front Axle/Steering:						
Oscillation Angle	32°		32°		32°	
Wheel Lean Angle	18°		18°		18°	
Steering Angle	50°		50°		50°	
Articulation Angle	20°		20°		20°	
Minimum Turning Radius**	7.2 m	23'8"	7.2 m	23'8"	7.4 m	24'3"
Front Frame Section Modulus:						
Min.	1619 cm ³	99 in³	1619 cm ³	99 in³	2083 cm ³	127 in³
Max.	3681 cm ³	225 in³	3681 cm ³	225 in³	4785 cm ³	291 in³
No. Circle Support Shoes	4		4		6	
Hydraulics: Pump Type	Axial Piston		Axial Piston		Axial Piston	
Max. Pump Flow	148 L/min	39 gpm	148 L/min	39 gpm	148 L/min	39 gpm
System Capacity	61 L	16 U.S. gal	61 L	16 U.S. gal	73 L	19 U.S. gal
Implement Pressure: Max.	24 150 kPa	3500 psi	24 150 kPa	3500 psi	24 150 kPa	3500 psi
Min.	3100 kPa	450 psi	3100 kPa	450 psi	3100 kPa	450 psi
Electrical:						
System Size	24V		24V		24V	
Std. Battery CCA @ 0° F	750		750		750	
Std. Alternator	35 amp		35 amp		35 amp	
GENERAL DIMENSIONS:						
Height (to top of ROPS)	3.11 m	10'2"	3.11 m	10'2"	3.11 m	10'2"
Height (stripped top)***	2.91 m	9'7"	2.91 m	9'7"	3.04 m	10'0"
Overall Length	8.14 m	26'9"	8.14 m	26'9"	8.45 m	27'9"
With Ripper & Pushplate	9.64 m	31'8"	9.64 m	31'8"	10.01 m	32'10"
Wheelbase	5.87 m	19'3"	5.87 m	19'3"	6.09 m	20'0"
Blade Base	2.60 m	8'6"	2.60 m	8'6"	2.57 m	8'5"
Overall Width (at top of front tires)	2.44 m	8'0"	2.44 m	8'0"	2.44 m	8'0"
Standard Blade: Length	3.66 m	12'0"	3.66 m	12'0"	3.66 m	12'0"
Height	610 mm	2'0"	610 mm	2'0"	610 mm	2'0"
Thickness	22 mm	0.87"	22 mm	0.87"	22 mm	0.87"
Lift Above Ground	410 mm	16.1"	410 mm	16.1"	452 mm	18.9"
Max. Shoulder Reach:◀						
Frame Straight	1.84 m	6'0"	1.84 m	6'0"	1.85 m	6'1"
Articulated Position	2.78 m	9'1"	2.78 m	9'1"	2.96 m	9'2"
Fuel Tank Capacity	284 L	75 U.S. gal	284 L	75 U.S. gal	284 L	75 U.S. gal

*Operating Weight — based on standard machine configuration, full fuel tank, coolant, lubricants and operator.

**Minimum Turning Radius — combining the use of articulated frame steering, front wheel steer and unlocked differential.

***Height (stripped top) — without ROPS, exhaust, or other easily removed encumbrances.

◀ Applicable for the standard blade with hydraulic sideshift and tip control. Maximum shoulder reach is obtainable to the right.

▲ Engine Power Management automatically reduces power in gears 1F-3F and 1R-2R.



MODEL	140H		160H	
Net Flywheel Power: Gears 4-8	138 kW	185 hp	149 kW	200 hp
Gears 1-3▲	123 kW	165 hp	134 kW	180 hp
Operating Weight*	13 552 kg	29,880 lb	14 416 kg	31,780 lb
Engine Model	3306 DIT		3306 DIT	
Rated Engine RPM	1900		1900	
No. of Cylinders	6		6	
Displacement	10.45 L	638 in ³	10.45 L	638 in ³
Max. Torque Rise	30%		30%	
No. of Speeds Forward/Reverse	8/6		8/6	
Top Speed Forward	41.1 km/h	25.5 mph	40.7 km/h	25.3 mph
Reverse	32.4 km/h	20.2 mph	32.1 km/h	20.0 mph
Std. Tires — Front & Rear	14.00-24 (10 PR) (G-2)		14.00-24 (10 PR) (G-2)	
Front Axle/Steering:				
Oscillation Angle	32°		32°	
Wheel Lean Angle	18°		18°	
Steering Angle	50°		50°	
Articulation Angle	20°		20°	
Minimum Turning Radius**	7.4 m	24'3"	7.4 m	24'3"
Front Frame Section Modulus:				
Min.	2083 cm ³	127 in ³	2083 cm ³	127 in ³
Max.	4785 cm ³	291 in ³	4785 cm ³	291 in ³
No. Circle Support Shoes	6		6	
Hydraulics: Pump Type	Axial Piston		Axial Piston	
Max. Pump Flow	155 L/min	40.9 gpm	155 L/min	40.9 gpm
System Capacity	73 L	19 U.S. gal	73 L	19 U.S. gal
Implement Pressure: Max.	24 150 kPa	3500 psi	24 150 kPa	3500 psi
Min.	3100 kPa	450 psi	3100 kPa	450 psi
Electrical:				
System Size	24V		24V	
Std. Battery CCA @ 0° F	750		750	
Std. Alternator	35 amp		35 amp	
GENERAL DIMENSIONS:				
Height (to top of ROPS)	3.12 m	10'3"	3.12 m	10'3"
Height (stripped top)***	3.04 m	10'0"	3.04 m	10'0"
Overall Length	8.49 m	27'10"	8.49 m	27'10"
With Ripper & Pushplate	10.01 m	32'10"	10.01 m	32'10"
Wheelbase	6.09 m	20'0"	6.09 m	20'0"
Blade Base	2.57 m	8'5"	2.52 m	8'3"
Overall Width (at top of front tires)	2.46 m	8'1"	2.46 m	8'1"
Standard Blade: Length	3.66 m	12'0"	4.27 m	14'0"
Height	610 mm	2'0"	686 mm	2'3"
Thickness	22 mm	0.87"	25 mm	1"
Lift Above Ground	452 mm	17.8"	452 mm	17.8"
Max. Shoulder Reach:◀				
Frame Straight	1.85 m	6'1"	1.85 m	6'1"
Articulated Position	2.96 m	9'2"	2.96 m	9'2"
Fuel Tank Capacity	284 L	75 U.S. gal	341 L	90 U.S. gal

*Operating Weight — based on standard machine configuration with full fuel tank, coolant, lubricants and operator.

**Minimum Turning Radius — combining the use of articulated frame steering, front wheel steer and unlocked differential.

***Height (stripped top) — without ROPS, exhaust, or other easily removed encumbrances.

◀ Applicable for the standard blade with hydraulic sideshift and tip control. Maximum shoulder reach is obtainable to the right.

▲ Engine Power Management automatically reduces power in gears 1F-3F and 1R-2R.



MODEL	120H		135H		12H	
Net Flywheel Power	93 kW	125 hp	101 kW	135 hp	104 kW	140 hp
Variable horsepower: Gears 4-8▲	104 kW	140 hp	116 kW	155 hp	—	
Operating Weight*	12 519 kg	27,600 lb	12 950 kg	28,550 lb	14 247 kg	31,410 lb
Engine Model	3116 DIT		3116 DIT		3306 DIT	
Rated Engine RPM	2000		2000		1900	
No. of Cylinders	6		6		6	
Displacement	6.6 L	403 in³	6.6 L	403 in³	10.45 L	638 in³
Max. Torque Rise	30%		30%		30%	
No. of Speeds Forward/Reverse	8/6		8/6		8/6	
Top Speed: Forward	42.6 km/h	26.5 mph	41.9 km/h	26.0 mph	39.7 km/h	24.7 mph
Reverse	33.7 km/h	20.9 mph	33.1 km/h	20.6 mph	31.3 km/h	19.5 mph
Std. Tires — Front & Rear	13.00-24 (10 PR) (G-2)		13.00-24 (10 PR) (G-2)		13.00-24 (10 PR) (G-2)	
Front Axle/Steering:						
Oscillation Angle	32°		32°		32°	
Wheel Lean Angle	18°		18°		18°	
Steering Angle	50°		50°		50°	
Articulation Angle	20°		20°		20°	
Minimum Turning Radius**	7.2 m	23'8"	7.2 m	23'8"	7.4 m	24'3"
Front Frame Section Modulus:						
Min.	1619 cm ³	99 in³	1619 cm ³	99 in³	2083 cm ³	127 in³
Max.	3681 cm ³	225 in³	3681 cm ³	225 in³	4785 cm ³	291 in³
No. Circle Support Shoes	4		4		6	
Hydraulics: Pump Type	Axial Piston		Axial Piston		Axial Piston	
Max. Pump Flow	148 L/min	39 gpm	148 L/min	39 gpm	196 L/min	51.9 gpm
System Capacity	68 L	17.7 U.S. gal	68 L	17.7 U.S. gal	80 L	20.8 U.S. gal
Implement Pressure: Max.	24 150 kPa	3500 psi	24 150 kPa	3500 psi	24 150 kPa	3500 psi
Min.	3100 kPa	450 psi	3100 kPa	450 psi	3100 kPa	450 psi
Interior Sound Level***	75 dBA		75 dBA		75 dBA	
Electrical:						
System Size	24V		24V		24V	
Std. Battery CCA @ 0° F	750		750		750	
Std. Alternator	35 amp		35 amp		35 amp	
GENERAL DIMENSIONS:						
Height (to top of ROPS)	3.11 m	10'2"	3.11 m	10'2"	3.11 m	10'2"
Height (stripped top)****	2.91 m	9'7"	2.91 m	9'7"	3.04 m	10'0"
Overall Length	8.26 m	27'1"	8.26 m	27'1"	8.57 m	28'1"
With Pushplate	8.50 m	27'10"	8.50 m	27'10"	10.01 m	32'10"
Wheelbase	5.87 m	19'3"	5.87 m	19'3"	6.09 m	20'0"
Blade Base	2.60 m	8'6"	2.60 m	8'6"	2.57 m	8'5"
Overall Width (at top of front tires)	2.44 m	8'0"	2.44 m	8'0"	2.44 m	8'0"
Standard Blade: Length	3.66 m	12'0"	3.66 m	12'0"	3.66 m	12'0"
Height	610 mm	2'0"	610 mm	2'0"	610 mm	2'0"
Thickness	22 mm	0.87"	22 mm	0.87"	22 mm	0.87"
Lift Above Ground	410 mm	16.1"	410 mm	16.1"	480 mm	18.9"
Max. Shoulder Reach:◀						
Frame Straight	1.91 m	6'3"	1.91 m	6'3"	1.97 m	6'6"
Articulated Position	2.85 m	9'4"	2.85 m	9'4"	2.91 m	9'7"
Fuel Tank Capacity	284 L	75 U.S. gal	284 L	75 U.S. gal	284 L	75 U.S. gal

*Operating Weight — based on standard machine configuration with full fuel tank, coolant, lubricants and operator.

**Minimum Turning Radius — combining the use of articulated frame steering, front wheel steer and unlocked differential.

***SAE J919.

****Height (stripped top) — without ROPS, exhaust, seat back or other easily removed encumbrances.

◀ Applicable for the standard blade with hydraulic sideshift and tip control. Maximum shoulder reach is obtainable to the right.

▲ Power is automatically increased in gears 4F-8F and 3R-6R.



MODEL	140H		143H		160H		163H	
Net Flywheel Power	123 kW	165 hp	123 kW	165 hp	134 kW	180 hp	134 kW	180 hp
Variable horsepower: Gears 4-8▲	138 kW	185 hp	138 kW	185 hp	149 kW	200 hp	149 kW	200 hp
Operating Weight*	14 724 kg	32,460 lb	15 023 kg	33,120 lb	15 586 kg	34,360 lb	16 538 kg	36,460 lb
Engine Model	3306 DIT		3306 DIT		3306 DIT		3306 DITA	
Rated Engine RPM	1900		1900		1900		1900	
No. of Cylinders	6		6		6		6	
Displacement	10.45 L	638 in ³	10.45 L	638 in ³	10.45 L	638 in ³	10.45 L	638 in ³
Max. Torque Rise	30%		30%		30%		33.5%	
No. of Speeds Forward/Reverse	8/6		8/6		8/6		8/6	
Top Speed Forward	41.1 km/h	25.5 mph	41.1 km/h	25.5 mph	40.7 km/h	25.3 mph	40.7 km/h	25.3 mph
Reverse	32.4 km/h	20.2 mph	32.4 km/h	20.2 mph	32.1 km/h	20.0 mph	32.1 km/h	20.0 mph
Std. Tires — Front & Rear	14.00-24 (10 PR) (G-2)		14.00-24 (10 PR) (G-2)		14.00-24 (12 PR) (G-2)		14.00-24 (12 PR) (G-2)	
Front Axle/Steering:								
Oscillation Angle	32°		32°		32°		32°	
Wheel Lean Angle	18°		18°		18°		18°	
Steering Angle	50°		50°		50°		50°	
Articulation Angle	20°		20°		20°		20°	
Minimum Turning Radius**	7.4 m	24'3"	7.4 m	24'3"	7.4 m	24'3"	7.4 m	24'3"
Front Frame Section Modulus:								
Min.	2083 cm ³	127 in ³	2083 cm ³	127 in ³	2083 cm ³	127 in ³	2083 cm ³	127 in ³
Max.	4785 cm ³	291 in ³	4785 cm ³	291 in ³	4785 cm ³	291 in ³	4785 cm ³	291 in ³
No. Circle Support Shoes	6		6		6		6	
Hydraulics: Pump Type	Axial Piston		Axial Piston		Axial Piston		Axial Piston	
Max. Pump Flow	206 L/min	54.4 gpm	206 L/min	54.4 gpm	206 L/min	54.4 gpm	206 L/min	54.4 gpm
System Capacity	80 L	20.8 U.S. gal	98 L	25.5 U.S. gal	80 L	20.8 U.S. gal	98 L	25.5 U.S. gal
Implement Pressure: Max.	24 150 kPa	3500 psi	24 150 kPa	3500 psi	24 150 kPa	3500 psi	24 150 kPa	3500 psi
Min.	3100 kPa	450 psi	3100 kPa	450 psi	3100 kPa	450 psi	3100 kPa	450 psi
Interior Sound Level***	75 dBA		77 dBA		75 dBA		77 dBA	
Electrical:								
System Size	24V		24V		24V		24V	
Std. Battery CCA @ 0° F	750		950		750		950	
Std. Alternator	50 amp		50 amp		50 amp		50 amp	
GENERAL DIMENSIONS:								
Height (to top of ROPS)	3.12 m	10'3"	3.12 m	10'3"	3.12 m	10'3"	3.12 m	10'3"
Height (stripped top)****	3.04 m	10'0"	3.04 m	10'0"	3.04 m	10'0"	3.04 m	10'0"
Overall Length	8.60 m	28'3"	8.60 m	28'3"	8.60 m	28'3"	8.60 m	28'3"
With Ripper & Pushplate	10.01 m	32'10"	10.01 m	32'10"	10.01 m	32'10"	10.01 m	32'10"
Wheelbase	6.09 m	20'0"	6.09 m	20'0"	6.09 m	20'0"	6.09 m	20'0"
Blade Base	2.57 m	8'5"	2.57 m	8'5"	2.52 m	8'3"	2.52 m	8'3"
Overall Width (at top of front tires)	2.46 m	8'1"	2.55 m	8'6"	2.48 m	8'2"	2.55 m	8'6"
Standard Blade: Length	3.66 m	12'0"	3.66 m	12'0"	4.27 m	14'0"	4.27 m	14'0"
Height	610 mm	2'0"	610 mm	2'0"	686 mm	2'3"	686 mm	2'3"
Thickness	22 mm	0.87"	22 mm	0.87"	25 mm	1"	25 mm	1"
Lift Above Ground	480 mm	18.9"	480 mm	18.9"	452 mm	17.8"	452 mm	17.8"
Max. Shoulder Reach:◀								
Frame Straight	1.97 m	6'6"	1.97 m	6'6"	1.96 m	6'5"	1.96 m	6'5"
Articulated Position	2.91 m	9'7"	2.91 m	9'7"	2.90 m	9'6"	2.90 m	9'6"
Fuel Tank Capacity	341 L	90 U.S. gal	341 L	90 U.S. gal	341 L	90 U.S. gal	341 L	90 U.S. gal

*Operating Weight — based on standard machine configuration with full fuel tank, coolant, lubricants and operator.

**Minimum Turning Radius — combining the use of articulated frame steering, front wheel steer and unlocked differential.

***SAE J919.

****Height (stripped top) — without ROPS, exhaust, seat back or other easily removed encumbrances.

◀Applicable for the standard blade with hydraulic sideshift and tip control. Maximum shoulder reach is obtainable to the right.

▲Power is automatically increased in gears 4F-8F and 3R-6R.

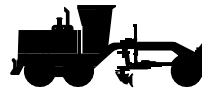

MODEL	14H		16H		24H	
Net Flywheel Power	160 kW	215 hp	205 kW	275 hp	373 kW	500 hp
Operating Weight*	18 784 kg	41,410 lb	24 748 kg	54,560 lb	61 950 kg	136,600 lb
Engine Model	3306 DITA		3406 DITA		3412E HEUI	
Rated Engine RPM	1850		1850		2000	
No. of Cylinders	6		6		12	
Displacement	10.45 L	638 in³	14.6 L	893 in³	27.0 L	1647 in³
Max. Torque Rise	30%		30%		30%	
No. of Speeds Forward/Reverse	8/8		8/8		6/3	
Top Speed Forward	42.7 km/h	26.5 mph	44.5 km/h	27.7 mph	37.7 km/h	23.4 mph
Reverse	47.3 km/h	29.4 mph	42.3 km/h	26.3 mph	36.1 km/h	22.4 mph
Std. Tires — Front & Rear	16.00-24 (12 PR) (G-2)		18.00-25 (12 PR) (E-2)		29.5-29	
Front Axle/Steering:						
Oscillation Angle	32°		32°		32°	
Wheel Lean Angle	18°		18°		18°	
Steering Angle	50°		50°		50°	
Articulation Angle	20°		20°		25°	
Minimum Turning Radius**	7.9 m	25'11"	8.2 m	27'0"	12.0 m	39'11"
Front Frame Section Modulus:						
Min.	2649 cm ³	162 in³	3746 cm ³	228 in³	9655 cm ³	589 in³
Max.	5091 cm ³	310 in³	8057 cm ³	491 in³	22 490 cm ³	1372 in³
No. Circle Support Shoes	6		6		8	
Hydraulics: Pump Type	Axial Piston		Axial Piston		Axial Piston	
Max. Pump Flow	243 L/min	64.1 gpm	243 L/min	64.1 gpm	445 L/min	116 gpm
System Capacity	125 L	32.5 U.S. gal	130 L	33.8 U.S. gal	250 L	65 U.S. gal
Implement Pressure: Max.	24 150 kPa	3500 psi	24 150 kPa	3500 psi	24 150 kPa	3500 psi
Min.	3100 kPa	450 psi	3100 kPa	450 psi	3100 kPa	450 psi
Interior Sound Level***	80 dBA		80 dBA		75 dBA	
Electrical:						
System Size	24V		24V		24V	
Std. Battery CCA @ 0° F	950		1300		1300	
Std. Alternator	50 amp		50 amp		100 amp	
GENERAL DIMENSIONS:						
Height (to top of ROPS)	3.34 m	10'11"	3.52 m	11'7"	4.35 m	14'3"
Height (stripped top)****	2.85 m	9'4"	3.11 m	10'2"	—	
Overall Length	9.21 m	30'2"	9.99 m	32'9"	14.16 m	46'6"
With Ripper & Pushplate	10.67 m	35'10"	11.62 m	38'2"	15.80 m	51'10"
Wheelbase	6.46 m	21'2"	6.96 m	22'10"	10.23 m	33'7"
Blade Base	2.86 m	9'5"	3.07 m	10'1"	4.08 m	13'4"
Overall Width (at top of front tires)	2.82 m	9'3"	3.08 m	10'1"	3.94 m	12'11"
Standard Blade: Length	4.27 m	14'0"	4.88 m	16'0"	7.32 m	24'0"
Height	686 mm	2'3"	787 mm	2'7"	1067 mm	3'6"
Thickness	25 mm	1"	25 mm	1"	50 mm	2"
Lift Above Ground	419 mm	16.5"	419 mm	16.5"	634 mm	2'1"
Max. Shoulder Reach:◀						
Frame Straight	2.08 m	6'10"	2.31 m	7'7"	3.22 m	10'7"
Articulated Position	3.07 m	10'1"	3.37 m	11'1"	5.05 m	16'7"
Fuel Tank Capacity	379 L	100 U.S. gal	492 L	130 U.S. gal	1207 L	319 U.S. gal

***Operating Weight** — based on standard machine configuration with full fuel tank, coolant, lubricants and operator. 24H includes ripper.

****Minimum Turning Radius** — combining the use of articulated frame steering, front wheel steer and unlocked differential.

***SAE J919.

******Height** (stripped top) — without ROPS, exhaust, seat back or other easily removed encumbrances.

◀Applicable for the standard blade with hydraulic sideshift and tip control. Maximum shoulder reach is obtainable to the right on 14H, both sides on 16H.



MODEL	120H		12H		140H		160H	
Net Flywheel Power: Gears 4-8 Gears 1-3▲	104 kW 93 kW	140 hp 125 hp	104 kW —	140 hp —	138 kW 123 kW	185 hp 165 hp	149 kW 134 kW	200 hp 180 hp
Operating Weight*	12 519 kg	27,600 lb	14 248 kg	31,410 lb	14 724 kg	32,460 lb	15 586 kg	34,360 lb
Engine Model	3116 DITA		3306 DIT		3306 DIT		3306 DITA	
Rated Engine RPM	2000		1900		1900		1900	
No. of Cylinders	6		6		6		6	
Displacement	6.6 L	403 in ³	10.45 L	638 in ³	10.45 L	638 in ³	10.45 L	638 in ³
Max. Torque Rise	30%		30%		30%		30%	
No. of Speeds Forward/Reverse	8/6		8/6		8/6		8/6	
Top Speed Forward	42.6 km/h	26.5 mph	39.7 km/h	24.7 mph	41.1 km/h	25.5 mph	40.7 km/h	25.3 mph
Reverse	33.7 km/h	20.9 mph	31.3 km/h	19.5 mph	32.4 km/h	20.2 mph	32.1 km/h	20.0 mph
Std. Tires — Front & Rear	13.00-24 (10 PR) (G-2)		13.00-24 (10 PR) (G-2)		14.00-24 (10 PR) (G-2)		14.00-24 (12 PR) (G-2)	
Front Axle/Steering:								
Oscillation Angle	32°		32°		32°		32°	
Wheel Lean Angle	18°		18°		18°		18°	
Steering Angle	50°		50°		50°		50°	
Articulation Angle	20°		20°		20°		20°	
Minimum Turning Radius**	7.2 m	23'8"	7.4 m	24'3"	7.4 m	24'3"	7.4 m	24'3"
Front Frame Section Modulus:								
Min.	1619 cm ³	99 in ³	2083 cm ³	127 in ³	2083 cm ³	127 in ³	2083 cm ³	127 in ³
Max.	3681 cm ³	225 in ³	4785 cm ³	291 in ³	4785 cm ³	291 in ³	4785 cm ³	291 in ³
No. Circle Support Shoes	4		6		6		6	
Hydraulics: Pump Type	Axial Piston		Axial Piston		Axial Piston		Axial Piston	
Max. Pump Flow	148 L/min	39 gpm	206 L/min	54.4 gpm	206 L/min	54.4 gpm	206 L/min	54.4 gpm
System Capacity	68 L	17.7 U.S. gal	80 L	20.8 U.S. gal	80 L	20.8 U.S. gal	80 L	20.8 U.S. gal
Implement Pressure: Max.	24 150 kPa	3500 psi	24 150 kPa	3500 psi	24 150 kPa	3500 psi	24 150 kPa	3500 psi
Min.	3100 kPa	450 psi	3100 kPa	450 psi	3100 kPa	450 psi	3100 kPa	450 psi
Interior Sound Level***	77 dBA		77 dBA		77 dBA		77 dBA	
Electrical:								
System Size	24V		24V		24V		24V	
Std. Battery CCA @ 0° F	950		950		950		950	
Std. Alternator	50 amp		50 amp		50 amp		50 amp	
GENERAL DIMENSIONS:								
Height (to top of ROPS)	3.11 m	10'2"	3.11 m	10'2"	3.12 m	10'3"	3.12 m	10'3"
Height (stripped top)****	2.91 m	9'7"	3.04 m	10'0"	3.04 m	10'0"	3.04 m	10'0"
Overall Length	8.26 m	27'1"	8.57 m	28'1"	8.60 m	28'3"	8.60 m	28'3"
With Ripper & Pushplate	9.76 m	32'0"	10.01 m	32'10"	10.01 m	32'10"	10.01 m	32'10"
Wheelbase	5.87 m	19'3"	6.09 m	20'0"	6.09 m	20'0"	6.09 m	20'0"
Blade Base	2.60 m	8'6"	2.57 m	8'5"	2.57 m	8'5"	2.52 m	8'3"
Overall Width (at top of front tires)	2.44 m	8'0"	2.44 m	8'0"	2.46 m	8'1"	2.48 m	8'2"
Standard Blade: Length	3.66 m	12'0"	3.66 m	12'0"	3.66 m	12'0"	4.27 m	14'0"
Height	610 mm	2'0"	610 mm	2'0"	610 mm	2'0"	686 mm	2'3"
Thickness	22 mm	0.87"	22 mm	0.87"	22 mm	0.87"	25 mm	1"
Lift Above Ground	410 mm	16.1"	480 mm	18.9"	480 mm	18.9"	452 mm	17.8"
Max. Shoulder Reach:◀								
Frame Straight	1.91 m	6'3"	1.97 m	6'6"	1.97 m	6'6"	1.96 m	6'5"
Articulated Position	2.85 m	9'4"	2.91 m	9'7"	2.91 m	9'7"	2.90 m	9'6"
Fuel Tank Capacity	284 L	75 U.S. gal	284 L	75 U.S. gal	284 L	75 U.S. gal	341 L	90 U.S. gal

* Operating Weight — based on standard machine configuration with full fuel tank, coolant, lubricants and operator.

** Minimum turning radius — combined use of frame articulation, front wheel steer and unlocked differential.

*** ISO 6394.

**** Height (stripped top) — without ROPS, exhaust, seat back or other easily removed encumbrances.

◀ Applicable for the standard blade with hydraulic sideshift and tip control. Maximum shoulder reach is obtainable to the right.

▲ Engine Power Management automatically reduces power in gears 1F-3F and 1R-2R.

Motor Graders

- Travel Speeds (All Versions)
- All Wheel Drive
- M10 Scarifiers

TRAVEL SPEEDS @ RATED RPM WITH STD. TIRES (ALL VERSIONS)

Gear		1		2		3		4		5		6		7		8	
		km/h	mph	km/h	mph	km/h	mph	km/h	mph	km/h	mph	km/h	mph	km/h	mph	km/h	mph
120H	Forward	3.6	2.3	5.0	3.1	7.2	4.5	9.9	6.2	15.6	9.7	21.3	13.2	29.3	18.2	42.6	26.5
	Reverse	2.9	1.8	5.4	3.4	7.8	4.9	12.3	7.7	23.1	14.4	33.7	20.9	—	—	—	—
135H	Forward	3.6	2.3	4.9	3.1	7.2	4.5	9.9	6.2	15.4	9.6	20.9	13.0	28.8	17.9	41.9	26.0
	Reverse	2.9	1.8	5.4	3.3	7.8	4.9	12.2	7.6	23.0	14.3	33.1	20.6	—	—	—	—
12H*	Forward	3.4	2.1	4.6	2.9	6.7	4.2	9.2	5.7	14.6	9.0	19.8	12.3	27.3	17.0	39.7	24.7
	Reverse	2.7	1.7	5.0	3.1	7.3	4.5	11.5	7.2	21.6	13.4	31.3	19.5	—	—	—	—
140H	Forward	3.5	2.2	4.8	3.0	7.0	4.3	9.6	6.0	15.1	9.4	20.5	12.8	28.3	17.6	41.1	25.5
	Reverse	2.8	1.7	5.2	3.2	7.6	4.7	11.9	7.4	22.3	13.9	32.4	20.2	—	—	—	—
143H	Forward	3.5	2.2	4.8	3.0	7.0	4.3	9.6	6.0	15.1	9.4	20.5	12.8	28.3	17.6	41.1	25.5
	Reverse	2.8	1.7	5.2	3.2	7.6	4.7	11.9	7.4	22.3	13.9	32.4	20.2	—	—	—	—
160H	Forward	3.5	2.2	4.8	3.0	7.0	4.3	9.6	6.0	15.0	9.3	20.3	12.6	28.0	17.4	40.7	25.3
	Reverse	2.8	1.7	5.2	3.2	7.6	4.7	11.8	7.3	22.3	13.9	32.1	20.0	—	—	—	—
163H	Forward	3.5	2.2	4.8	3.0	7.0	4.3	9.6	6.0	15.0	9.3	20.3	12.6	28.0	17.4	40.7	25.3
	Reverse	2.8	1.7	5.2	3.2	7.6	4.7	11.8	7.3	22.3	13.9	32.1	20.0	—	—	—	—
14H	Forward	3.7	2.3	5.3	3.3	7.1	4.4	10.3	6.4	15.5	9.6	21.8	13.5	29.5	18.3	42.7	26.5
	Reverse	4.1	2.6	5.8	3.6	7.9	4.9	11.4	7.1	17.7	10.7	24.1	15.0	32.7	20.3	47.3	29.4
16H	Forward	3.9	2.4	5.5	3.4	7.4	4.6	10.7	6.7	16.2	10.1	22.7	14.1	30.8	19.1	44.5	27.7
	Reverse	3.7	2.3	5.2	3.2	7.0	4.4	10.2	6.3	15.4	9.6	21.6	13.4	29.2	18.2	42.3	26.3
24H Wide-based tires	Forward	3.2	2.0	4.9	3.1	8.5	5.3	13.1	8.1	24.3	15.1	37.7	23.4	—	—	—	—
	Reverse	4.7	2.9	12.6	7.8	36.1	22.4	—	—	—	—	—	—	—	—	—	—

*For 12H Standard Version travel speeds, multiply by 1.05.

ALL WHEEL DRIVE (AWD)	143H	163H		
Power with AWD engaged	138 kW	185 hp	149 kW	200 hp
Working Range:				
Forward Gears	1-7		1-7	
Reverse Gears	1-5		1-5	
Pump Type	Axial Piston		Axial Piston	
System Capacity	175 L/min	46.2 gpm	175 L/min	46.2 gpm
Operating Pressure: Max.	35 000 kPa	5080 psi	35 000 kPa	5080 psi
Min.	5500 kPa	800 psi	5500 kPa	800 psi

M10 — MOUNTED SCARIFIERS	120H, 135H, 12H, 140H, 143H, 160H, 163H			
Type	V		Straight*	
Working Width	1184 mm	46.6"	1800 mm	71"
Depth (Max.)	292 mm	11.5"	317 mm	12.5"
Number of Shank Holders	11		17	
Spacing	116 mm	4.6"	111 mm	4.38"

*Available on NA Versions only.

MOTOR GRADER/ RIPPER	120H/135H†		12H/140H/143H/ 160H/163H		14H		16H		24H	
Parallelogram — Rear Mounted	Ripper		Ripper/Scarifier		Ripper		Ripper		Ripper	
Tire Size (std.) Front & Rear	13.00-24		14.00-24***		16.00-24		18.00-25		29.5-29	
Dimensions:										
Scarifier										
Maximum digging depth	—		411 mm	16.2"	—		—		—	
Number of pockets	—		9		—		—		—	
Spacing	—		267 mm	10.5"	—		—		—	
Ripper Shank										
Maximum digging depth	262 mm	10.3"	462 mm	18.2"	401 mm	15.8"	452 mm	17.8"	490 mm	1'7.3"
Maximum reach at ground line*	1034 mm	3'4.7"	1168 mm	3'10"	1380 mm	4'6.3"	1500 mm	4'11"	1165 mm	3'9.9"
Maximum ground clearance under tip (shank pinned in bottom hole)	652 mm	2'1.6"	521 mm	1'8.5"	663 mm	2'2.1"	673 mm	2'2.5"	739 mm	2'5.1"
Maximum ramp angle, ripper up (shank pinned in bottom hole)	23°		23°		21°		21°		20°	
Shank Section	36 x 76 mm 1.4" x 3.0"		61 x 140 mm 2.4" x 5.5"		61 x 140 mm 2.4" x 5.5"		76 x 178 mm 3" x 7"		78 x 178 mm 3" x 7"	
Ripper Beam										
Overall Width	2.30 m	7'7"	2.30 m	7'7"	2.60 m	8'6"	2.98 m	9'9"	3.91 m	12'10"
Height	152 mm	6"	152 mm	6"	165 mm	6.5"	214 mm	8.4"	216 mm	8.5"
Length	182 mm	7.2"	229 mm	9"	211 mm	8.3"	254 mm	10"	254 mm	10"
Number of Pockets	5		5		7		7		7	
Pocket Spacing:										
Inside	533 mm	1'9"	533 mm	1'9"	472 mm	1'7"	500 mm	1'8"	593 mm	1'11.4"
Middle	533 mm	1'9"	533 mm	1'9"	373 mm	15"	445 mm	17.5"	604 mm	1'11.8"
Outside	533 mm	1'9"	533 mm	1'9"	373 mm	15"	445 mm	17.5"	604 mm	1'11.8"
Shank Gauge	2.13 m	7'0"	2.13 m	7'0"	2.44 m	8'0"	—		—	
Installed weights:										
Ripper with standard shank	613 kg	1350 lb	1060.5 kg	2336 lb	1542 kg	3399 lb	2177 kg	4799 lb	2812 kg	6186 lb
Each additional shank	11 kg	24 lb	31 kg	68 lb	31 kg	68 lb	68 kg	150 lb	68 kg	150 lb
Ripper Forces ◀										
Penetration Force ◀	4343 kg	9566 lb	8047 kg**	17,740 lb**	10 676 kg	23,541 lb	10 163 kg	22,410 lb	117 720 N	39,987 lb
Pryout Force	2279 kg	5020 lb	9281 kg	20,460 lb	11 804 kg	26,028 lb	15 323 kg	33,788 lb	263 880 N	59,373 lb

*Measured from mounting face on frame.

**Applies to 12H, 140H and 143H. Penetration force for 160H and 163H is 8518 kg (18,780 lb).

***12H std. tire is 13.00-24.

†Available on Standard and ES Versions only.

NOTE: See Section 1 for Ripper Tips.

◀This value may vary slightly with various vehicle configurations.

BALDERSON WORK TOOLS

Work Tools	120H	135H	12H	140H	143H	160H	163H	14H	16H
Lift Group	X	X	X	X	X	X	X	X	X
V-Plow	X	X	X	X	X	X	X	X	
One Way Plow	X	X	X	X	X	X	X	X	
Manual Reversible Plow	X	X	X	X	X	X	X	X	
Hydraulic Reversible Plow	X	X	X	X	X	X	X	X	
Snow Wing	X	X	X	X	X	X	X	X	
Scarifier	X	X	X	X	X	X	X	X	X
Manual Angle Blade	X	X	X	X	X	X	X	X	
Hydraulic Angle Blade	X	X	X	X	X	X	X	X	
Straight Blade	X	X	X	X	X	X	X	X	X

This list is not all inclusive. Contact Balderson for special attachment needs.

NOTE: Balderson Attachments for Cat H-Series Motor Graders require additional hydraulics. All front-mounted attachments require a Balderson Quick Attach-Detach Parallel Lift Group. Contact Balderson for details.

EXCAVATORS

CONTENTS

EXCAVATORS

Specifications	4-2
Shipping Dimensions	4-16
General Dimensions	4-27
Shipping Information	4-28
Major Component Weights	4-29
Range Dimensions:	
One-piece Boom	4-34
Variable Adjustable Boom	4-53
Hydraulic Adjustable Boom	4-54
Lifting Capacity (definition)	4-58
Lifting Capacity at Ground Level (charts)	4-60
Bucket Capacity (definition)	4-91
Curl and Crowd Forces	4-91
Bucket Specifications	4-102
Working Weights (bucket & payload)	4-120
Equipping Excavators:	
Long Reach	4-123
Ditch Cleaning	4-125
Demolition Arrangements	4-127
Machine Selection (tracks vs. wheels)	4-134
Stick/Bucket Combinations	4-135
Shoe Selection and Ground Pressure	4-137
Quick Coupler Systems	4-140
Major Attachment Summary	4-141
Special Attachments	4-146
Cycle Time Estimating Charts	4-147
Earthmoving Production	4-150
Production Estimating Tables	4-152
Trenching Production	4-153

5000 SERIES

Features	4-161
Specifications	4-162
Digging Envelopes	4-168
Shipping Information	4-170
General Dimensions	4-172
Shoe Selection	4-173
Curl and Crowd Forces	4-173
Bucket Selection	4-174
Vital Information Management System (VIMS)	4-174
Estimating Cycle Time	4-175
Production Tables	4-177

MATERIAL HANDLING ARRANGEMENTS

Range Dimensions & Capacities	4-182
-------------------------------	-------



MODEL	301.5		307B		307B SB		307	
Sourcing			Japan		Japan		France	
Flywheel Power	13 kW	17.4 hp	40 kW	54 hp	40 kW	54 hp	40 kW	54 hp
Operating Weight*	1673 kg	3690 lb	6500 kg	14,320 lb	7400 kg	16,310 lb	7600 kg	16,760 lb
Bucket Capacity	0.018-	0.023-	0.14-	0.18-	0.14-	0.18-	0.09-	0.12-
Range (heaped)	0.056 m ³	0.073 yd³	0.28 m ³	0.37 yd³	0.28 m ³	0.37 yd³	0.35 m ³	0.46 yd³
Engine Model	3003		4M40E1		4M40E1		3054	
Rated Engine RPM	2300		2100		2100		1800	
No. of Cylinders	3		4		4		4	
Bore	75 mm	2.95"	95 mm	3.7"	95 mm	3.7"	100 mm	3.9"
Stroke	72 mm	2.83"	100 mm	3.9"	100 mm	3.9"	127 mm	5"
Displacement	0.95 L	58.2 in³	2.84 L	173 in³	2.84 L	173 in³	3.99 L	243 in³
Max. Implement								
Hydraulic Pump	2 × 16/	2 × 4.2/						
Output at Rated RPM	1 × 17	1 × 4.5	2 × 64	2 × 17	2 × 64	2 × 17	2 × 67	2 × 18
	L/min	gpm	L/min	gpm	L/min	gpm	L/min	gpm
Relief Valve Settings:								
Implement Circuits	18 600 kPa	2700 psi	27 460 kPa	3980 psi	27 460 kPa	3980 psi	27 460 kPa	3980 psi
Travel Circuits	18 600 kPa	2700 psi	31 380 kPa	4550 psi	31 380 kPa	4550 psi	31 380 kPa	4550 psi
Swing Circuits	17 200 kPa	2500 psi	22 060 kPa	3200 psi	24 030 kPa	3480 psi	20 590 kPa	2990 psi
Pilot Circuits	—		3930 kPa	570 psi	3930 kPa	570 psi	3000 kPa	440 psi
Maximum Drawbar								
Pull	13.6 kN	3060 lb	55 kN	12,130 lb	55 kN	12,130 lb	48 kN	10,800 lb
Maximum Travel	Two Speed Travel		Two Speed Travel		Two Speed Travel			
Speed at	Lo: 2.2 km/h	1.4 mph	Lo: 3.5 km/h	2.2 mph	Lo: 3.5 km/h	2.2 mph	4.1 km/h	2.5 mph
Rated RPM	Hi: 4.4 km/h	2.7 mph	Hi: 5 km/h	3.1 mph	Hi: 5 km/h	3.1 mph		
Width of Standard								
Track Shoe	230 mm	9"	450 mm	18"	450 mm	18"	450 mm	18"
Overall Track Length	1390 mm	4'7"	2760 mm	9'1"	2760 mm	9'1"	2660 mm	8'9"
Ground Contact Area								
with Std. Shoe	0.64 m ²	990 in²	2.11 m ²	3271 in²	2.11 m ²	3271 in²	2.04 m ²	3160 in²
Track Gauge	750 mm	2'6"	1750 mm	5'9"	1750 mm	5'9"	1750 mm	5'9"
Fuel Tank Refill								
Capacity	22 L	5.8 U.S. gal	135 L	36 U.S. gal	135 L	36 U.S. gal	110 L	29 U.S. gal
Hydraulic System								
(includes tank)	37 L	9.8 U.S. gal	94 L	25 U.S. gal	105 L	28 U.S. gal	105 L	28 U.S. gal

*Operating weight includes coolant, lubricants, full fuel tank, cab, standard shoes, bucket, medium stick, and operator 75 kg (165 lb).

NOTE: Certain models may not be available in all Sales areas.

Specifications may also vary by Sales area.

Contact your Caterpillar District Office for details.



MODEL	311B		312B		312B		312B L	
Sourcing	Japan		Japan		France		Japan	
Flywheel Power	59 kW	79 hp	63 kW	84 hp	66 kW	88 hp	63 kW	84 hp
Operating Weight*	11 125 kg	24,550 lb	12 435 kg	27,410 lb	13 000 kg	28,665 lb	12 935 kg	28,520 lb
Bucket Capacity	0.35-	0.46-	0.35-	0.46-	0.24-	0.31-	0.35-	0.46-
Range (heaped)	0.78 m ³	1.02 yd³	0.78 m ³	1.02 yd³	0.75 m ³	0.98 yd³	0.78 m ³	1.02 yd³
Engine Model	3064T		3064T		3054T		3064T	
Rated Engine RPM	1800		1900		1900		1900	
No. of Cylinders	4		4		4		4	
Bore	102 mm	4"	102 mm	4"	100 mm	3.9"	102 mm	4"
Stroke	130 mm	5.1"	130 mm	5.1"	127 mm	5"	130 mm	5.1"
Displacement	4.25 L	259 in³	4.25 L	259 in³	4 L	244 in³	4.25 L	259 in³
Max. Implement Hydraulic Pump Output at Rated RPM	2 × 108 L/min	2 × 29 gpm	2 × 120 L/min	2 × 32 gpm	2 × 120 L/min	2 × 32 gpm	2 × 120 L/min	2 × 32 gpm
Relief Valve Settings:								
Implement Circuits	29 900 kPa	4340 psi	29 900 kPa	4340 psi	30 000 kPa	4350 psi	29 900 kPa	4340 psi
Travel Circuits	34 300 kPa	4980 psi	34 300 kPa	4980 psi	34 300 kPa	4973 psi	34 300 kPa	4980 psi
Swing Circuits	23 050 kPa	3340 psi	23 050 kPa	3340 psi	25 000 kPa	3625 psi	23 050 kPa	3340 psi
Pilot Circuits	3930 kPa	570 psi	3930 kPa	570 psi	4000 kPa	580 psi	3930 kPa	570 psi
Maximum Drawbar Pull	95 kN	21,360 lb	106 kN	23,835 lb	104 kN	23,400 lb	106 kN	23,835 lb
Maximum Travel Speed at Rated RPM	Two Speed Travel Lo: 3.8 km/h 2.4 mph Hi: 5.5 km/h 3.4 mph		Two Speed Travel Lo: 3.8 km/h 2.4 mph Hi: 5.5 km/h 3.4 mph		Two Speed Travel Lo: 3.6 km/h 2.2 mph Hi: 5.5 km/h 3.4 mph		Two Speed Travel Lo: 3.8 km/h 2.4 mph Hi: 5.5 km/h 3.4 mph	
Width of Standard Track Shoe	500 mm	1'8"	500 mm	1'8"	500 mm	1'8"	600 mm	2'0"
Overall Track Length	3320 mm	10'11"	3490 mm	11'5"	3490 mm	11'5"	3750 mm	12'4"
Ground Contact Area with Std. Shoe	2.86 m ²	4430 in²	3.03 m ²	4700 in²	2.78 m ²	4309 in²	3.95 m ²	5925 in²
Track Gauge	1990 mm	6'6"	1990 mm	6'6"	1990 mm	6'6"	1990 mm	6'6"
Fuel Tank Refill Capacity	250 L	66 U.S. gal	250 L	66 U.S. gal	250 L	66 U.S. gal	250 L	66 U.S. gal
Hydraulic System (includes tank)	157 L	41 U.S. gal	162 L	43 U.S. gal	151 L	40 U.S. gal	162 L	43 U.S. gal

*Operating weight includes coolant, lubricants, full fuel tank, standard shoes, bucket, medium stick, and operator 75 kg (165 lb).

NOTE: Certain models may not be available in all Sales areas.

Specifications may also vary by Sales area.

Contact your Caterpillar District Office for details.



MODEL	312B L		315B		315B L		315B L	
Sourcing	France		Japan		Japan		France	
Flywheel Power	66 kW	88 hp	74 kW	99 hp	74 kW	99 hp	80 kW	107 hp
Operating Weight*	13 270 kg	29,260 lb	15 800 kg	34,800 lb	16 400 kg	36,200 lb	16 200 kg	35,721 lb
Bucket Capacity	0.24-	0.31-	0.37-	0.5-	0.37-	0.5-	0.35-	0.45-
Range (heaped)	0.75 m ³	0.98 yd³	0.84 m ³	1.1 yd³	0.84 m ³	1.1 yd³	0.9 m ³	1.17 yd³
Engine Model	3054T		3046T		3046T		3054TA	
Rated Engine RPM	1900		2100		2100		2100	
No. of Cylinders	4		6		6		4	
Bore	100 mm	3.9"	94 mm	3.7"	94 mm	3.7"	100 mm	3.9"
Stroke	127 mm	5"	120 mm	4.7"	120 mm	4.7"	127 mm	5"
Displacement	4 L	244 in³	5 L	305 in³	5 L	305 in³	4 L	244 in³
Max. Implement Hydraulic Pump Output at Rated RPM	2 × 120 L/min	2 × 32 gpm	2 × 132 L/min	2 × 35 gpm	2 × 132 L/min	2 × 35 gpm	2 × 132 L/min	2 × 35 gpm
Relief Valve Settings:								
Implement Circuits	30 000 kPa	4350 psi	34 300 kPa	4980 psi	34 320 kPa	4980 psi	35 000 kPa	5075 psi
Travel Circuits	34 300 kPa	4970 psi	34 300 kPa	4980 psi	34 320 kPa	4980 psi	34 300 kPa	4973 psi
Swing Circuits	25 000 kPa	3625 psi	23 050 kPa	3340 psi	23 050 kPa	3340 psi	26 500 kPa	3842 psi
Pilot Circuits	4000 kPa	580 psi	3930 kPa	570 psi	3930 kPa	570 psi	4000 kPa	580 psi
Maximum Drawbar Pull	118 kN	26,550 lb	131 kN	29,540 lb	131 kN	29,540 lb	132 kN	29,700 lb
Maximum Travel Speed at Rated RPM	Two Speed Travel Lo: 3.2 km/h 1.9 mph Hi: 5.5 km/h 3.4 mph		Two Speed Travel Lo: 3.3 km/h 2.1 mph Hi: 5.5 km/h 3.4 mph		Two Speed Travel Lo: 3.3 km/h 2.1 mph Hi: 5.5 km/h 3.4 mph		Two Speed Travel Lo: 3.2 km/h 1.9 mph Hi: 5.5 km/h 3.4 mph	
Width of Standard Track Shoe	600 mm	2'0"	500 mm	1'8"	600 mm	2'0"	500 mm	1'8"
Overall Track Length	3750 mm	12'4"	3685 mm	12'1"	3970 mm	13'0"	3960 mm	12'6"
Ground Contact Area with Std. Shoe	3.65 m ²	5654 in²	3.16 m ²	4898 in²	4.14 m ²	6420 in²	3.16 m ²	4907 in²
Track Gauge	1990 mm	6'6"	1990 mm	6'6"	1990 mm	6'6"	1990 mm	6'6"
Fuel Tank Refill Capacity	250 L	66 U.S. gal	280 L	74 U.S. gal	280 L	74 U.S. gal	280 L	74 U.S. gal
Hydraulic System (includes tank)	151 L	40 U.S. gal	188 L	49.7 U.S. gal	188 L	49.7 U.S. gal	188 L	49.7 U.S. gal

*Operating weight includes coolant, lubricants, full fuel tank, standard shoes, bucket, medium stick, and operator 75 kg (165 lb).

NOTE: Certain models may not be available in all Sales areas.

Specifications may also vary by Sales area.

Contact your Caterpillar District Office for details.



MODEL	318B L		318B L		318B LN		318B LN	
Sourcing	Japan		France		Japan		France	
Flywheel Power	86 kW	115 hp	86 kW	115 hp	86 kW	115 hp	86 kW	115 hp
Operating Weight*	18 410 kg	40,590 lb	17 700 kg	39,028 lb	18 020 kg	39,730 lb	17 160 kg	37,838 lb
Bucket Capacity	0.45-	0.59-	0.41-	0.53-	0.45-	0.59-	0.41-	0.53-
Range (heaped)	0.8 m ³	1.05 yd³	1.35 m ³	1.75 yd³	0.8 m ³	1.05 yd³	1.35 m ³	1.75 yd³
Engine Model	3046T		3046T		3046T		3046T	
Rated Engine RPM	2100		2100		2100		2100	
No. of Cylinders	6		6		6		6	
Bore	94 mm	3.7"	94 mm	3.7"	94 mm	3.7"	94 mm	3.7"
Stroke	120 mm	4.7"	120 mm	4.7"	120 mm	4.7"	120 mm	4.7"
Displacement	5 L	305 in³	5 L	305 in³	5 L	305 in³	5 L	305 in³
Max. Implement Hydraulic Pump Output at Rated RPM	2 × 150 L/min	2 × 40 gpm	2 × 150 L/min	2 × 40 gpm	2 × 150 L/min	2 × 40 gpm	2 × 150 L/min	2 × 40 gpm
Relief Valve Settings:								
Implement Circuits	34 320 kPa	4980 psi	35 000 kPa	5075 psi	34 320 kPa	4980 psi	35 000 kPa	5075 psi
Travel Circuits	34 320 kPa	4980 psi	34 300 kPa	4973 psi	34 320 kPa	4980 psi	34 300 kPa	4973 psi
Swing Circuits	23 050 kPa	3340 psi	26 500 kPa	3842 psi	23 050 kPa	3340 psi	26 500 kPa	3842 psi
Pilot Circuits	3930 kPa	570 psi	4000 kPa	580 psi	3930 kPa	570 psi	4000 kPa	580 psi
Maximum Drawbar Pull	176 kN	39,550 lb	154 kN	34,650 lb	176 kN	39,550 lb	154 kN	34,650 lb
Maximum Travel Speed at Rated RPM	Two Speed Travel Lo: 2.5 km/h 1.6 mph Hi: 3.9 km/h 2.4 mph		Two Speed Travel Lo: 2.8 km/h 1.7 mph Hi: 5.5 km/h 3.4 mph		Two Speed Travel Lo: 2.5 km/h 1.6 mph Hi: 3.9 km/h 2.4 mph		Two Speed Travel Lo: 2.8 km/h 1.7 mph Hi: 5.5 km/h 3.4 mph	
Width of Standard Track Shoe	600 mm	2'0"	600 mm	2'0"	500 mm	1'8"	500 mm	1'8"
Overall Track Length	4075 mm	13'4"	4075 mm	13'4"	4075 mm	13'4"	4075 mm	13'4"
Ground Contact Area with Std. Shoe	4.26 m ²	6600 in²	3.92 m ²	6073 in²	3.55 m ²	5500 in²	3.26 m ²	5061 in²
Track Gauge	2200 mm	7'3"	2200 mm	7'3"	1990 mm	6'6"	1995 mm	6'6.5"
Fuel Tank Refill Capacity	280 L	74 U.S. gal	280 L	74 U.S. gal	280 L	74 U.S. gal	280 L	74 U.S. gal
Hydraulic System (includes tank)	188 L	49.7 U.S. gal	188 L	49.7 U.S. gal	188 L	49.7 U.S. gal	188 L	49.7 U.S. gal

*Operating weight includes coolant, lubricants, full fuel tank, standard shoes, bucket, medium stick, and operator 75 kg (165 lb).

NOTE: Certain models may not be available in all Sales areas.

Specifications may also vary by Sales area.

Contact your Caterpillar District Office for details.



MODEL	M312		M315		M318		M320	
Flywheel Power	85.1 kW	114 hp	92.4 kW	124 hp	104.4 kW	140 hp	104.4 kW	140 hp
Operating Weight*	13 810 kg	30,450 lb	15 730 kg	34,685 lb	17 910 kg	39,490 lb	19 410 kg	20,640 lb
Bucket Capacity	0.24-	0.31-	0.24-	0.31-	0.4-	0.52-	0.41-	0.54-
Range (heaped)	0.86 m ³	1.12 yd³	0.86 m ³	1.12 yd³	1.05 m ³	1.37 yd³	1.35 m ³	1.77 yd³
Engine Model	3054TA		3054TA		3116T		3116T	
Rated Engine RPM	2000		2300		2000		2000	
No. of Cylinders	4		4		6		6	
Bore	100 mm	3.9"	100 mm	3.9"	102 mm	4"	102 mm	4"
Stroke	127 mm	5"	127 mm	5"	130 mm	5.1"	130 mm	5.1"
Displacement	3.99 L	243 in³	3.99 L	243 in³	6.6 L	402.6 in³	6.6 L	402.6 in³
Max. Implement								
Hydraulic Pump								
Output at	190+80	50+21	220+80	58+21	260+112	69+30	320+112	85+30
Rated RPM	L/min	gpm	L/min	gpm	L/min	gpm	L/min	gpm
Relief Valve Setting	33 000 kPa	4785 psi	33 000 kPa	4785 psi	33 000 kPa	4785 psi	33 000 kPa	4785 psi
Tires — standard	Dual 10.00-20 16PR		Dual 10.00-20 16PR		Dual 10.00-20 16PR		Dual 11.00-20 16PR	
— optional	Dual 10.00-20 14PR		Dual 10.00-20 14PR		Dual 10.00-20 14PR		Dual 10.00-20 Solid	
	Dual 11.00-20 16PR		Dual 11.00-20 16PR		Dual 11.00-20 16PR		Single 18R-19.5 XF	
	Single 18R-19.5 XF		Single 18R-19.5 XF		Single 18R-19.5 XF		Single 18R-22.5 XF	
			Single 18R-22.5 XF		Single 18R-22.5 XF		—	
Max. Travel Speed	34 km/h	21 mph	34 km/h	21 mph	34 km/h	21 mph	20 km/h	12 mph
Tread Width**	1913 mm	6'3"	1913 mm	6'3"	1913 mm	6'3"	1913 mm	6'3"
Wheel Base	2500 mm	8'2"	2500 mm	8'2"	2600 mm	8'6"	2750 mm	9'0"
Width Over Tires**	2500 mm	8'2"	2500 mm	8'2"	2500 mm	8'2"	2950 mm	9'8"
Ground Clearance**	375 mm	14.8"	375 mm	14.8"	375 mm	14.8"	360 mm	14.1"
Fuel Tank Refill								
Capacity	230 L	60.8 U.S. gal	240 L	63.4 U.S. gal	320 L	84.5 U.S. gal	370 L	98 U.S. gal
Hydraulic System								
(includes tank)	180 L	47.6 U.S. gal	210 L	55.5 U.S. gal	220 L	58.1 U.S. gal	300 L	79 U.S. gal

*Operating weight includes full fuel tank, operator 75 kg (165 lb), one-piece boom, mid-size stick and bucket, and two sets of outriggers.

**With standard tires.

NOTE: Standard cold inflation pressure for all tires is 650 kPa (94 psi).

Certain models may not be available in all Sales areas.

Specifications may also vary by Sales area.

Contact your Caterpillar District Office for details.



MODEL	320B		320B		320B L		320B L	
Sourcing	Japan, Brazil		Belgium		Japan, Brazil		Belgium	
Flywheel Power	96 kW	128 hp	96 kW	128 hp	96 kW	128 hp	96 kW	128 hp
Operating Weight*	19 400 kg	42,770 lb	20 520 kg	45,250 lb	20 720 kg	45,690 lb	21 380 kg	47,140 lb
Bucket Capacity	0.45-	0.59-	0.41-	0.5-	0.45-	0.59-	0.41-	0.5-
Range (heaped)	1.5 m ³	1.96 yd³	1.5 m ³	1.9 yd³	1.5 m ³	1.96 yd³	1.5 m ³	1.9 yd³
Engine Model	3066T		3116T		3066T		3116T	
Rated Engine RPM	1800		1800		1800		1800	
No. of Cylinders	6		6		6		6	
Bore	102 mm	4"	105 mm	4.1"	102 mm	4"	105 mm	4.1"
Stroke	130 mm	5.1"	127 mm	5"	130 mm	5.1"	127 mm	5"
Displacement	6.4 L	389 in³	6.6 L	403 in³	6.4 L	389 in³	6.6 L	403 in³
Max. Implement Hydraulic Pump at Rated RPM	2 × 185 L/min	2 × 49 gpm	2 × 185 L/min	2 × 49 gpm	2 × 185 L/min	2 × 49 gpm	2 × 185 L/min	2 × 49 gpm
Relief Valve Settings:								
Implement Circuits	34 300 kPa	4980 psi	34 300 kPa	4980 psi	34 300 kPa	4980 psi	34 300 kPa	4980 psi
Travel Circuits	34 300 kPa	4980 psi	34 300 kPa	4980 psi	34 300 kPa	4980 psi	34 300 kPa	4980 psi
Swing Circuits	23 000 kPa	3340 psi	23 000 kPa	3340 psi	23 000 kPa	3340 psi	23 000 kPa	3340 psi
Pilot Circuits	4140 kPa	600 psi	4140 kPa	600 psi	4140 kPa	600 psi	4140 kPa	600 psi
	Two Speed Travel		Two Speed Travel		Two Speed Travel		Two Speed Travel	
Maximum Drawbar Pull	Lo: 177 kN	39,800 lb	Lo: 177 kN	39,800 lb	Lo: 177 kN	39,800 lb	Lo: 177 kN	39,800 lb
	Hi: 106 kN	23,810 lb	Hi: 106 kN	23,810 lb	Hi: 106 kN	23,810 lb	Hi: 107 kN	23,810 lb
Maximum Travel Speed at Rated RPM	Lo: 3.4 km/h	2.1 mph	Lo: 3.4 km/h	2.1 mph	Lo: 3.4 km/h	2.1 mph	Lo: 3.4 km/h	2.1 mph
	Hi: 5.5 km/h	3.4 mph	Hi: 5.5 km/h	3.4 mph	Hi: 5.5 km/h	3.4 mph	Hi: 5.5 km/h	3.4 mph
Width of Standard Track Shoe	600 mm	2'0"	600 mm	2'0"	800 mm	2'8"	550 mm	1'10"
Overall Track Length	4075 mm	13'4"	4075 mm	13'4.4"	4455 mm	14'7"	4360 mm	14'4"
Ground Contact Area with Std. Shoe	4.26 m ²	6600 in²	4.26 m ²	6600 in²	6.29 m ²	9750 in²	4.15 m ²	6433 in²
Track Gauge	2200 mm	7'3"	2200 mm	7'2.6"	2380 mm	7'10"	1895 mm	6'3"
Fuel Tank Refill Capacity	340 L	90 U.S. gal	290 L	77 U.S. gal	340 L	90 U.S. gal	290 L	77 U.S. gal

*Operating weight includes coolant, lubricants, full fuel tank, standard shoes, bucket and operator 75 kg (165 lb).

NOTE: Certain models may not be available in all Sales areas.

Specifications may also vary by Sales area.

Contact your Caterpillar District Office for details.



MODEL	320B N		320B LN		320B S		322B	
Sourcing	Japan		Belgium		Belgium		Japan	
Flywheel Power	96 kW	128 hp	96 kW	128 hp	96 kW	128 hp	114 kW	153 hp
Operating Weight*	19 930 kg	43,940 lb	20 810 kg	45,900 lb	22 530 kg	49,680 lb	22 760 kg	50,180 lb
Bucket Capacity	0.45-	0.59-	0.41-	0.5-	0.41-	0.5-	0.45-	0.6-
Range (heaped)	1.5 m ³	1.96 yd³	1.5 m ³	1.9 yd³	1.5 m ³	1.9 yd³	1.8 m ³	2.4 yd³
Engine Model	3066T		3116T		3116T		3116T	
Rated Engine RPM	1800		1800		1800		1950	
No. of Cylinders	6		6		6		6	
Bore	102 mm	4"	105 mm	4.1"	105 mm	4.1"	105 mm	4.1"
Stroke	130 mm	5.1"	127 mm	5"	127 mm	5"	127 mm	5"
Displacement	6.4 L	389 in³	6.6 L	403 in³	6.6 L	403 in³	6.6 L	403 in³
Max. Implement Hydraulic Pump at Rated RPM	2 × 185 L/min	2 × 49 gpm	2 × 185 L/min	2 × 49 gpm	2 × 185 L/min	2 × 49 gpm	2 × 205 L/min	2 × 54 gpm
Relief Valve Settings:								
Implement Circuits	34 300 kPa	4980 psi	34 300 kPa	4980 psi	34 300 kPa	4980 psi	34 300 kPa	4980 psi
Travel Circuits	34 300 kPa	4980 psi	34 300 kPa	4980 psi	34 300 kPa	4980 psi	34 300 kPa	4980 psi
Swing Circuits	23 050 kPa	3340 psi	23 050 kPa	3340 psi	23 050 kPa	3340 psi	27 500 kPa	3980 psi
Pilot Circuits	4140 kPa	600 psi	4140 kPa	600 psi	4140 kPa	600 psi	4140 kPa	600 psi
	Two Speed Travel		Two Speed Travel		Two Speed Travel		Two Speed Travel	
Maximum Drawbar Pull	Lo: 177 kN	39,800 lb	Lo: 177 kN	39,800 lb	Lo: 177 kN	39,800 lb	Lo: 194 kN	43,650 lb
	Hi: 106 kN	23,810 lb	Hi: 106 kN	23,810 lb	Hi: 106 kN	23,810 lb	Hi: 108 kN	24,500 lb
Maximum Travel Speed at Rated RPM	Lo: 3.4 km/h	2.1 mph	Lo: 3.4 km/h	2.1 mph	Lo: 3.4 km/h	2.1 mph	Lo: 3.4 km/h	2.1 mph
	Hi: 5.5 km/h	3.4 mph	Hi: 5.5 km/h	3.4 mph	Hi: 5.5 km/h	3.4 mph	Hi: 5.5 km/h	3.4 mph
Width of Standard Track Shoe	500 mm	1'8"	500 mm	1'8"	550 mm	1'9"	600 mm	2'0"
Overall Track Length	4075 mm	13'4"	4460 mm	14'8"	4358 mm	14'4"	4260 mm	14'0"
Ground Contact Area with Std. Shoe	3.55 m ²	5500 in²	3.9 m ²	6045 in²	4.15 m ²	6433 in²	4.48 m ²	6940 in²
Track Gauge	2200 mm	7'3"	1995 mm	6'6.5"	1895 mm	6'3"	2390 mm	7'10"
Fuel Tank Refill Capacity	340 L	90 U.S. gal	290 L	77 U.S. gal	290 L	77 U.S. gal	340 L	90 U.S. gal

*Operating weight includes coolant, lubricants, full fuel tank, standard shoes, bucket and operator 75 kg (165 lb).

NOTE: Certain models may not be available in all Sales areas.

Specifications may also vary by Sales area.

Contact your Caterpillar District Office for details.



MODEL	322B L		322B L		322B LN	
Sourcing	Japan, U.S.		Belgium		Belgium	
Flywheel Power	114 kW	153 hp	114 kW	153 hp	114 kW	153 hp
Operating Weight*	23 990 kg	52,890 lb	24 590 kg	54,220 lb	23 810 kg	52,500 lb
Bucket Capacity						
Range (heaped)	0.45-1.9 m ³	0.6-2.5 yd ³	0.63-1.9 m ³	0.82-2.5 yd ³	0.63-1.9 m ³	0.82-2.5 yd ³
Engine Model	3116TA		3116TA		3116TA	
Rated Engine RPM	1950		1950		1950	
No. of Cylinders	6		6		6	
Bore	105 mm	4.1"	105 mm	4.1"	105 mm	4.1"
Stroke	127 mm	5"	127 mm	5"	127 mm	5"
Displacement	6.6 L	403 in ³	6.6 L	403 in ³	6.6 L	403 in ³
Max. Implement Hydraulic Pump at Rated RPM	2 × 205 L/min	2 × 54 gpm	2 × 205 L/min	2 × 54.2 gpm	2 × 205 L/min	2 × 54 gpm
Relief Valve Settings:						
Implement Circuits	34 300 kPa	4980 psi	34 300 kPa	4980 psi	34 300 kPa	4980 psi
Travel Circuits	34 300 kPa	4980 psi	34 300 kPa	4980 psi	34 300 kPa	4980 psi
Swing Circuits	27 500 kPa	3980 psi	27 500 kPa	3980 psi	27 500 kPa	3980 psi
Pilot Circuits	4140 kPa	600 psi	4140 kPa	600 psi	4140 kPa	600 psi
	Two Speed Travel		Two Speed Travel		Two Speed Travel	
Maximum Drawbar Pull	Lo: 194 kN Hi: 108 kN	43,650 lb 24,500 lb	Lo: 194 kN Hi: 108 kN	43,650 lb 24,500 lb	Lo: 194 kN Hi: 108 kN	43,650 lb 24,500 lb
Maximum Travel Speed at Rated RPM	Lo: 3.4 km/h Hi: 5.5 km/h	2.1 mph 3.4 mph	Lo: 3.4 km/h Hi: 5.5 km/h	2.1 mph 3.4 mph	Lo: 3.4 km/h Hi: 5.5 km/h	2.1 mph 3.4 mph
Width of Standard Track Shoe	800 mm	2'8"	800 mm	2'8"	600 mm	2'0"
Overall Track Length	4630 mm	15'2"	4640 mm	15'3"	4640 mm	15'3"
Ground Contact Area with Std. Shoe	6.58 m ²	10,200 in ²	6.58 m ²	10,200 in ²	4.94 m ²	7650 in ²
Track Gauge	2590 mm	8'6"	2590 mm	8'6"	2590 mm	8'6"
Fuel Tank Refill Capacity	340 L	90 U.S. gal	340 L	90 U.S. gal	340 L	90 U.S. gal

*Operating weight includes coolant, lubricants, full fuel tank, standard shoes, bucket and operator 75 kg (165 lb).

NOTE: Certain models may not be available in all Sales areas. Specifications may also vary by Sales area. Contact your Caterpillar District Office for details.



MODEL	325B		325B L		325B L		325B LN	
Sourcing	Japan		Japan, U.S.		Belgium		Belgium	
Flywheel Power	125 kW	168 hp	125 kW	168 hp	125 kW	168 hp	125 kW	168 hp
Operating Weight*	25 900 kg	57,100 lb	27 530 kg	60,700 lb	28 590 kg	63,040 lb	27 070 kg	59,690 lb
Bucket Capacity	0.7-	0.92-	0.7-	0.92-	0.63-	0.82-	0.63-	0.82-
Range (heaped)	2.2 m ³	2.88 yd³	2.2 m ³	2.88 yd³	1.9 m ³	2.5 yd³	1.9 m ³	2.5 yd³
Engine Model	3116TA		3116TA		3116TA		3116TA	
Rated Engine RPM	2000		2000		2000		2000	
No. of Cylinders	6		6		6		6	
Bore	105 mm	4.1"	105 mm	4.1"	105 mm	4.1"	105 mm	4.1"
Stroke	127 mm	5"	127 mm	5"	127 mm	5"	127 mm	5"
Displacement	6.6 L	403 in³	6.6 L	403 in³	6.6 L	403 in³	6.6 L	403 in³
Max. Implement Hydraulic Pump at Rated RPM	2 × 210 L/min	2 × 55.5 gpm	2 × 214 L/min	2 × 56.5 gpm	2 × 210 L/min	2 × 55 gpm	2 × 210 L/min	2 × 55 gpm
Relief Valve Settings:								
Implement Circuits	34 300 kPa	4980 psi	34 300 kPa	4980 psi	34 300 kPa	4980 psi	34 300 kPa	4980 psi
Travel Circuits	34 300 kPa	4980 psi	34 300 kPa	4980 psi	34 300 kPa	4980 psi	34 300 kPa	4980 psi
Swing Circuits	27 500 kPa	3980 psi	29 400 kPa	4250 psi	27 500 kPa	3980 psi	27 500 kPa	3980 psi
Pilot Circuits	4140 kPa	600 psi	4100 kPa	595 psi	4140 kPa	600 psi	4140 kPa	600 psi
	Two Speed Travel		Two Speed Travel		Two Speed Travel		Two Speed Travel	
Maximum Drawbar Pull	Lo: 215 kN	48,350 lb	Lo: 215 kN	48,350 lb	Lo: 215 kN	48,350 lb	Lo: 215 kN	48,350 lb
	Hi: 131 kN	29,540 lb	Hi: 131 kN	29,540 lb	Hi: 131 kN	29,540 lb	Hi: 131 kN	29,540 lb
Maximum Travel Speed at Rated RPM	Lo: 3.1 km/h	1.9 mph	Lo: 3.1 km/h	1.9 mph	Lo: 3.1 km/h	1.9 mph	Lo: 3.1 km/h	1.9 mph
	Hi: 5 km/h	3.1 mph	Hi: 5 km/h	3.1 mph	Hi: 5 km/h	3.1 mph	Hi: 5 km/h	3.1 mph
Width of Standard Track Shoe	600 mm	2'0"	800 mm	2'8"	800 mm	2'8"	600 mm	2'0"
Overall Track Length	4360 mm	14'4"	4660 mm	15'3"	4660 mm	15'3"	4660 mm	15'3"
Ground Contact Area with Std. Shoe	4.55 m ²	7050 in²	6.56 m ²	10,200 in²	6.56 m ²	10,200 in²	4.92 m ²	7630 in²
Track Gauge	2390 mm	7'10"	2590 mm	8'6"	2590 mm	8'6"	2390 mm	7'10"
Fuel Tank Refill Capacity	420 L	111 U.S. gal	420 L	111 U.S. gal	420 L	111 U.S. gal	420 L	111 U.S. gal

*Operating weight includes coolant, lubricants, full fuel tank, standard shoes, bucket and operator 75 kg (165 lb).

NOTE: Certain models may not be available in all Sales areas.

Specifications may also vary by Sales area.

Contact your Caterpillar District Office for details.



MODEL	330B		330B L		330B L		330B LN	
Sourcing	Japan		Japan, U.S.		Belgium		Belgium	
Flywheel Power	165 kW	222 hp	165 kW	222 hp	165 kW	222 hp	165 kW	222 hp
Operating Weight*	32 420 kg	71,470 lb	33 730 kg	74,360 lb	34 180 kg	75,370 lb	33 730 kg	74,380 lb
Bucket Capacity	0.7-	0.92-	0.7-	0.92-	0.66-	0.86-	0.66-	0.86-
Range (heaped)	2.2 m ³	2.88 yd³	2.2 m ³	2.88 yd³	2.1 m ³	2.75 yd³	2.1 m ³	2.75 yd³
Engine Model	3306TA		3306TA		3306TA		3306TA	
Rated Engine RPM	1800		1800		1800		1800	
No. of Cylinders	6		6		6		6	
Bore	121 mm	4.75"	121 mm	4.75"	121 mm	4.75"	121 mm	4.75"
Stroke	152 mm	6"	152 mm	6"	152 mm	6"	152 mm	6"
Displacement	10.5 L	638 in³	10.5 L	638 in³	10.5 L	640 in³	10.5 L	638 in³
Max. Implement Hydraulic Pump at Rated RPM	2 × 240 L/min	2 × 63 gpm	2 × 240 L/min	2 × 63 gpm	2 × 240 L/min	2 × 63 gpm	2 × 240 L/min	2 × 63 gpm
Relief Valve Settings:								
Implement Circuits	34 300 kPa	4980 psi	34 300 kPa	4980 psi	34 300 kPa	4980 psi	34 300 kPa	4980 psi
Travel Circuits	34 300 kPa	4980 psi	34 300 kPa	4980 psi	34 300 kPa	4980 psi	34 300 kPa	4980 psi
Swing Circuits	27 500 kPa	3980 psi	27 500 kPa	3980 psi	27 500 kPa	3980 psi	27 500 kPa	3980 psi
Pilot Circuits	4140 kPa	600 psi	4140 kPa	600 psi	4140 kPa	600 psi	4140 kPa	600 psi
	Two Speed Travel		Two Speed Travel		Two Speed Travel		Two Speed Travel	
Maximum Drawbar Pull	Lo: 268 kN	60,250 lb	Lo: 268 kN	60,250 lb	Lo: 268 kN	60,250 lb	Lo: 268 kN	60,250 lb
	Hi: 148 kN	33,300 lb	Hi: 148 kN	33,300 lb	Hi: 148 kN	33,300 lb	Hi: 148 kN	33,300 lb
Maximum Travel Speed at Rated RPM	Lo: 2.7 km/h	1.7 mph	Lo: 2.7 km/h	1.7 mph	Lo: 2.7 km/h	1.7 mph	Lo: 2.7 km/h	1.7 mph
	Hi: 4.6 km/h	2.9 mph	Hi: 4.6 km/h	2.9 mph	Hi: 4.6 km/h	2.9 mph	Hi: 4.6 km/h	2.9 mph
Width of Standard Track Shoe	600 mm	2'0"	750 mm	2'6"	750 mm	2'5.5"	600 mm	2'0"
Overall Track Length	4.58 m	15'0"	5.02 m	16'6"	5.02 m	16'6"	5.02 m	16'6"
Ground Contact Area with Std. Shoe	4.74 m ²	7350 in²	6.58 m ²	10,200 in²	6.58 m ²	10,200 in²	5.26 m ²	8150 in²
Track Gauge	2.59 m	8'6"	2.59 m	8'6"	2.59 m	8'6"	2.39 m	7'10"
Fuel Tank Refill Capacity	560 L	148 U.S. gal	560 L	148 U.S. gal	560 L	148 U.S. gal	560 L	148 U.S. gal

*Operating weight includes coolant, lubricants, full fuel tank, standard shoes, bucket and operator 75 kg (165 lb).

NOTE: Certain models may not be available in all Sales areas.

Specifications may also vary by Sales area.

Contact your Caterpillar District Office for details.



MODEL	345B		345B L – FIX		345B L – VG		345B L – VG	
Sourcing	Japan		Japan, U.S.		U.S.		Belgium	
Flywheel Power	216 kW	290 hp	216 kW	290 hp	216 kW	290 hp	216 kW	290 hp
Operating Weight*	43 000 kg	94,800 lb	44 900 kg	98,990 lb	46 900 kg	103,400 lb	47 615 kg	105,000 lb
Bucket Capacity	1.3-	1.7-	1.3-	1.7-	1.3-	1.7-	1.8-	2.3-
Range (heaped)	2.6 m ³	3.4 yd³	2.6 m ³	3.4 yd³	2.6 m ³	3.4 yd³	3.5 m ³	4.6 yd³
Engine Model	3176CATAAC		3176CATAAC		3176CATAAC		3176CATAAC	
Rated Engine RPM	2000		2000		2000		2000	
No. of Cylinders	6		6		6		6	
Bore	125 mm	4.92"	125 mm	4.92"	125 mm	4.92"	125 mm	4.92"
Stroke	140 mm	5.51"	140 mm	5.51"	140 mm	5.51"	140 mm	5.51"
Displacement	10.3 L	628.5 in³	10.3 L	628.5 in³	10.3 L	628.5 in³	10.3 L	628.5 in³
Max. Implement Hydraulic Pump at Rated RPM	2 × 320 L/min	2 × 85 gpm	2 × 320 L/min	2 × 85 gpm	2 × 320 L/min	2 × 85 gpm	2 × 320 L/min	2 × 85 gpm
Relief Valve Settings:								
Implement Circuits	34 300 kPa	4980 psi	34 300 kPa	4980 psi	34 300 kPa	4980 psi	34 300 kPa	4980 psi
Travel Circuits	34 300 kPa	4980 psi	34 300 kPa	4980 psi	34 300 kPa	4980 psi	34 300 kPa	4980 psi
Swing Circuits	28 400 kPa	4125 psi	28 400 kPa	4125 psi	28 400 kPa	4125 psi	28 400 kPa	4125 psi
Pilot Circuits	3930 kPa	570 psi	3930 kPa	570 psi	3930 kPa	570 psi	3930 kPa	570 psi
Maximum Drawbar Pull	322 kN	72,400 lb	322 kN	72,400 lb	322 kN	72,400 lb	322 kN	72,400 lb
Maximum Travel	Two Speed Travel		Two Speed Travel		Two Speed Travel		Two Speed Travel	
Speed at	Lo: 3.2 km/h	2 mph	Lo: 3.2 km/h	2 mph	Lo: 3.2 km/h	2 mph	Lo: 3.2 km/h	2 mph
Rated RPM	Hi: 4.4 km/h	2.7 mph	Hi: 4.4 km/h	2.7 mph	Hi: 4.4 km/h	2.7 mph	Hi: 4.4 km/h	2.7 mph
Width of Standard Track Shoe	600 mm	2'0"	750 mm	2'6"	750 mm	2'6"	600 mm	2'0"
Overall Track Length	5.03 m	16'6"	5.36 m	17'7"	5.34 m	17'6"	5.34 m	17'6"
Ground Contact Area with Std. Shoe	5.26 m ²	8150 in²	7.07 m ²	10,960 in²	5.63 m ²	8730 in²	5.63 m ²	8727 in²
Track Gauge	2.74 m	9'0"	2.74 m	9'0"	2.74 m	9'0"	2.74 m	9'0"
Extended	—		—		2.89 m	9'6"	2.89 m	9'6"
Fuel Tank Refill Capacity	600 L	159 U.S. gal	600 L	159 U.S. gal	600 L	159 U.S. gal	600 L	159 U.S. gal

*Operating weight includes coolant, lubricants, full fuel tank, standard shoes, bucket and operator 75 kg (165 lb).

NOTE: Certain models may not be available in all Sales areas.

Specifications may also vary by Sales area.

Contact your Caterpillar District Office for details.



MODEL	350		350 L		375		375	
Sourcing	Japan		Japan		Japan, U.S.		Belgium	
Flywheel Power	213 kW	286 hp	213 kW	286 hp	319 kW	428 hp	319 kW	428 hp
Operating Weight*	48 040 kg	105,930 lb	49 010 kg	108,070 lb	75 770 kg	167,070 lb	79 160 kg**	174,550 lb**
Bucket Capacity	1.3-	1.7-	0.9-	1.2-	1.5-	1.96-	3.6-	4.7-
Range (heaped)	2.6 m ³	3.4 yd³	2.6 m ³	3.4 yd³	4.4 m ³	5.75 yd³	5.6 m ³	7.3 yd³
Engine Model	3306ATAAC		3306ATAAC		3406CATAAC		3406CATAAC	
Rated Engine RPM	2000		2000		1800		1800	
No. of Cylinders	6		6		6		6	
Bore	121 mm	4.75"	121 mm	4.75"	137 mm	5.4"	137 mm	5.4"
Stroke	152 mm	6"	152 mm	6"	165 mm	6.5"	165 mm	6.5"
Displacement	10.5 L	638 in³	10.5 L	638 in³	14.6 L	893 in³	14.6 L	891 in³
Max. Implement Hydraulic Pump at Rated RPM	2 × 335 L/min	2 × 89 gpm	2 × 335 L/min	2 × 89 gpm	2 × 430 L/min	2 × 114 gpm	2 × 435 L/min	2 × 115 gpm
Relief Valve Settings:								
Implement Circuits	31 400 kPa	4550 psi	31 400 kPa	4550 psi	31 400 kPa	4550 psi	31 400 kPa	4550 psi
Travel Circuits	34 300 kPa	4980 psi	34 300 kPa	4980 psi	34 300 kPa	4980 psi	34 300 kPa	4980 psi
Swing Circuits	27 000 kPa	3910 psi	27 000 kPa	3910 psi	27 500 kPa	3980 psi	—	—
Pilot Circuits	3430 kPa	500 psi	3500 kPa	508 psi	3500 kPa	508 psi	3480 kPa	505 psi
Maximum Drawbar Pull	336 kN	75,600 lb	336 kN	75,600 lb	546 kN	122,800 lb	Two Speed Travel Lo: 546 kN 122,795 lb Hi: 278 kN 62,390 lb	
Maximum Travel Speed at Rated RPM	Two Speed Travel Lo: 3.3 km/h 2 mph Hi: 4.6 km/h 2.9 mph		Two Speed Travel Lo: 3.3 km/h 2 mph Hi: 4.6 km/h 2.9 mph		Two Speed Travel Lo: 2.7 km/h 1.7 mph Hi: 9.4 km/h 2.7 mph		Lo: 2.7 km/h 1.7 mph Hi: 4.5 km/h 2.8 mph	
Width of Standard Track Shoe	600 mm	2'0"	750 mm	2'6"	610 mm	2'0"	610 mm	2'0"
Overall Track Length	5.11 m	16'9"	5.57 m	18'3"	5.84 m	19'2"	5.840 m	19'1.9"
Ground Contact Area with Std. Shoe	5.30 m ²	8220 in²	7.30 m ²	11,320 in²	6.14 m ²	9520 in²	6.14 m ²	9520 in²
Track Gauge	2.55 m	8'4"	2.55 m	8'4"	2.75 m	9'0"	2.75 m	9'4"
Extended	3 m	9'10"	3 m	9'10"	3.51 m	11'6"	3.51 m	11'6"
Fuel Tank Refill Capacity	700 L	185 U.S. gal	700 L	185 U.S. gal	990 L	262 U.S. gal	990 L	262 U.S. gal

*Operating weight includes coolant, lubricants, full fuel tank, one-piece boom, long stick, small profile bucket, operator 75 kg (165 lb) and wide shoes.

**Operating weight includes coolant, lubricants, fuel fuel tank, reach boom, medium stick configuration, bucket and operator 75 kg (165 lb).

NOTE: Certain models may not be available in all Sales areas.

Specifications may also vary by Sales area.

Contact your Caterpillar District Office for details.



MODEL	375 L		375 L	
	Japan, U.S.		Belgium	
Sourcing				
Flywheel Power	319 kW	428 hp	319 kW	428 hp
Operating Weight*	78 870 kg	173,910 lb	80 700 kg**	177,940 lb**
Bucket Capacity Range (heaped)	1.5-4.4 m ³	1.96-5.75 yd ³	2.7-5.6 m ³	3.5-7.3 yd ³
Engine Model	3406CATTAC		3406CATAAC	
Rated Engine RPM	1800		1800	
No. of Cylinders	6		6	
Bore	137 mm	5.4"	137 mm	5.4"
Stroke	165 mm	6.5"	165 mm	6.5"
Displacement	14.6 L	893 in ³	14.6 L	891 in ³
Max. Implement Hydraulic Pump Output at Rated RPM	2 × 430 L/min	2 × 114 gpm	2 × 435 L/min	2 × 115 gpm
Relief Valve Settings:				
Implement Circuits	31 400 kPa	4550 psi	31 400 kPa	4550 psi
Travel Circuits	34 300 kPa	4980 psi	34 300 kPa	4980 psi
Swing Circuits	27 500 kPa	3980 psi	—	—
Pilot Circuits	3500 kPa	508 psi	3480 kPa	505 psi
Maximum Drawbar Pull	546 kN	122,800 lb	Two Speed Travel Lo: 546 kN 122,795 lb Hi: 278 kN 62,390 lb	
Maximum Travel Speed at Rated RPM	Two Speed Travel Lo: 2.7 km/h 1.7 mph Hi: 4.4 km/h 2.7 mph		Lo: 2.7 km/h 1.7 mph Hi: 4.5 km/h 2.8 mph	
Width of Standard Track Shoe	750 mm	2'6"	610 mm	2'0"
Overall Track Length	6.36 m	20'10"	6360 mm	20'10.4"
Ground Contact Area with Std. Shoe	8.33 m ²	12,910 in ²	6.77 m ²	10,500 in ²
Track Gauge	2.75 m	9'0"	2.75 m	9'4"
Extended	3.51 m	11'6"	3.51 m	11'6"
Fuel Tank Refill Capacity	990 L	262 U.S. gal	990 L	262 U.S. gal

*Operating weight includes coolant, lubricants, full fuel tank, one-piece boom, long stick, small profile bucket, operator 75 kg (165 lb) and wide shoes.

**Operating weight includes coolant, lubricants, full fuel tank, reach boom, medium stick configuration, bucket and operator 75 kg (165 lb).

NOTE: Certain models may not be available in all Sales areas.

Specifications may also vary by Sales area.

Contact your Caterpillar District Office for details.



MODEL	5130B ME		5230 ME	
Sourcing	U.S.		U.S.	
Flywheel Power	597 kW	800 hp	1095 kW	1470 hp
Operating Weight*	182 000 kg	401,000 lb	316 600 kg	698,000 lb
Bucket Capacity Range (heaped)	8.5-18.3 m ³	11-24 yd³	13-27.5 m ³	17-36 yd³
Engine Model	3508B EUI		3516 EUI	
Rated Engine RPM	1750		1750	
No. of Cylinders	8		16	
Bore	170 mm	6.7"	170 mm	6.7"
Stroke	190 mm	7.5"	190 mm	7.5"
Displacement	34.5 L	2105 in³	69 L	4210 in³
Max. Hydraulic Pump Output at Rated RPM: Implement	4 × 372 L/min	4 × 99 gpm	6 × 372 L/min	6 × 99 gpm
Swing	1 × 464 L/min	1 × 123 gpm	2 × 464 L/min	2 × 123 gpm
Relief Valve Settings:				
Implement Circuits	31 000 kPa	4550 psi	31 000 kPa	4550 psi
Travel Circuits	35 000 kPa	5080 psi	35 000 kPa	5080 psi
Swing Circuits: Accelerate	35 000 kPa	5080 psi	35 000 kPa	5080 psi
Decelerate	25 000 kPa	3620 psi	25 000 kPa	3620 psi
Pilot Circuits	4000 kPa	580 psi	4000 kPa	580 psi
Maximum Drawbar Pull	872 kN	196,000 lb	1545 kN	340,875 lb
Maximum Travel Speed at Rated RPM	3.3 km/h	2.1 mph	2.5 km/h	1.6 mph
Overall Track Length	5.55 m**	18'3"***	6.26 m**	20'6"***
Width of Standard Track Shoe	800 mm	2'8"	1300 mm	4'4"
Ground Contact Area with Std. Shoe	9.8 m ²	15,200 in²	18 m ²	27,900 in²
Track Gauge	4.72 m	15'6"	5.2 m	17'
Fuel Tank Refill Capacity	2600 L	687 U.S. gal	5330 L	1386 U.S. gal

* Operating weight includes coolant, lubricants, full fuel tank, one-piece boom, medium stick, bucket, standard counterweight and operator 75 kg (165 lb).

** Measured from center of driver to center of idler.

NOTE: Certain models may not be available in all Sales areas.

Specifications may also vary by Sales area.

Contact your Caterpillar District Office for details.

SHIPPING DIMENSIONS KEYS**307 through 5230**

- A Cab height
 - B House width, without mirrors
 - C Track width, standard shoe
 - D Ground clearance, frame
 - E Ground clearance, counterweight
 - F Tail swing radius
 - G Overall track length
(grouser bar to grouser bar)
 - H Overall transport length
 - J Shipping height
 - K Length of track on ground
 - L Track gauge
-

M312 through M320

- A Cab height
 - B Transport width
 - C Overall tire width
 - D Ground clearance, frame
 - E House height
 - F Exhaust stack height
 - G Overall length
(outrigger to outrigger)
 - H Overall transport length
 - J Transport height
 - K Ground clearance, counterweight
 - L Transport length without boom
 - M Cab swing radius
 - N Tail swing radius
 - O Wheelbase length
 - P Overall width
(outrigger to outrigger)
-

Shipping Dimensions

Excavators

- 301.5
- 307B
- 307B SB
- 307
- 311B
- 312B
- 312B L
- 315B
- 315B L

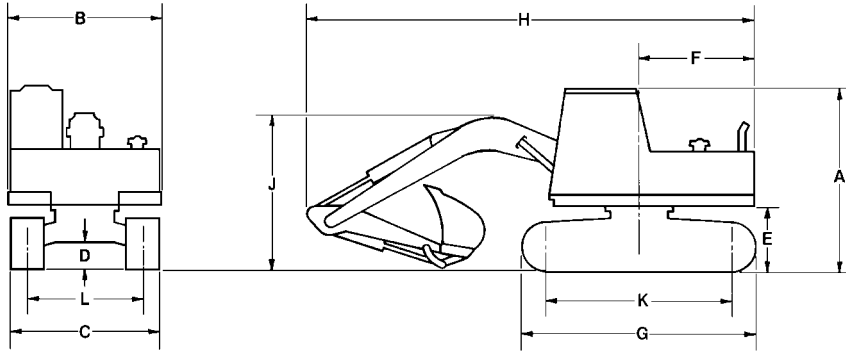

	301.5		307B		307B SB		307		311B		312B	
Sourcing	—		Japan		Japan		France		Japan		Japan	
	mm	ft	mm	ft	mm	ft	mm	ft	mm	ft	mm	ft
A	2190	7'2"	2630	8'8"	2640	8'8"	2660	8'9"	2760	9'1"	2760	9'1"
B	980	3'3"	2280	7'6"	2280	7'6"	2280	7'6"	2495	8'2"	2495	8'2"
C	980	3'3"	2200	7'3"	2200	7'3"	2200	7'3"	2490	8'2"	2490	8'2"
D	220	8.7"	380	15"	380	15"	365	14"	455	18"	455	18"
E	460	18"	785	2'7"	785	2'7"	700	2'6"	920	3'0"	920	3'0"
F	1070	3'6"	1750	5'9"	1750	5'9"	1750	5'9"	2130	7'0"	2130	7'0"
G	1390	4'7"	2760	9'1"	2760	9'1"	2660	8'9"	3320	10'11"	3490	11'5"
H	3690	12'1"	6080	19'11"	6730	22'1"	6310	20'8"	7250	23'9"	7595	24'11"
J*	—	—	2630	8'8"	2640	8'8"	2750	9'0"	2760	9'1"	2760	9'1"
K	1020	3'4"	2120	6'11"	2120	6'11"	2050	6'9"	2610	8'7"	2780	9'1"
L	—	—	1750	5'9"	1750	5'9"	1750	5'9"	1990	6'6"	1990	6'6"

	312B		312B L		312B L		315B		315B L		315B L	
Sourcing	France		Japan		France		Japan		Japan		France	
	mm	ft	mm	ft	mm	ft	mm	ft	mm	ft	mm	ft
A	2910	9'6"	2760	9'1"	2760	9'1"	2880	9'5"	2880	9'5"	3000	9'11"
B	2480	8'2"	2595	8'6"	2480	8'2"	2490	8'2"	2490	8'2"	2480	8'2"
C	2490	8'2"	2590	8'6"	2590	8'6"	2490	8'2"	2590	8'6"	2490	8'2"
D	435	17"	455	18"	435	17"	460	18"	460	18"	462	18"
E	900	2'11"	920	3'0"	900	2'11"	1030	3'5"	1030	3'5"	1022	3'4"
F	2090	6'10"	2130	7'0"	2090	6'10"	2450	8'0"	2450	8'0"	2430	8'0"
G	3490	11'5"	3750	12'4"	3750	12'4"	3690	12'1"	3970	13'0"	3965	13'0"
H	7590	24'10"	7595	24'11"	7590	24'10"	8500	28'0"	8500	28'0"	8475	27'9"
J*	2660	8'9"	2760	9'1"	2660	8'9"	2880	9'5"	2880	9'5"	2870	9'5"
K	2780	9'1"	3040	12'0"	3040	12'0"	2880	9'5"	3170	10'5"	3166	10'4"
L	1990	6'6"	1990	6'6"	1990	6'6"	1990	6'6"	1990	6'6"	1990	6'6"

*Varies with stick length.

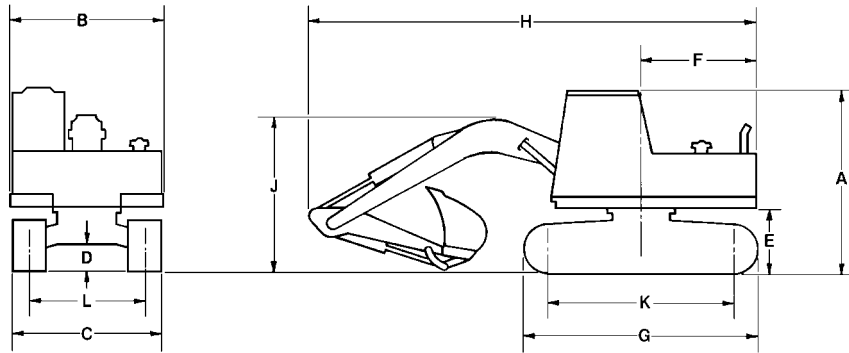

Sourcing	318B L		318B L		318B LN		318B LN	
	Japan	France	Japan	France	Japan	France	Japan	France
	mm	ft	mm	ft	mm	ft	mm	ft
A	2930	9'7"	3020	9'10"	2930	9'7"	3020	9'10"
B	2800	9'2"	2490	8'2"	2800	9'2"	2490	8'2"
C	2800	9'2"	2800	9'2"	2490	8'2"	2495	8'2"
D	475	1'7"	470	1'8"	475	1'7"	470	1'8"
E	1045	3'5"	1030	3'4"	1045	3'5"	1030	3'4"
F	2450	8'0"	2350	7'8"	2450	8'0"	2350	7'8"
G	4075	13'4"	4075	13'4"	4075	13'4"	4075	13'4"
H	8720	28'7"	8687	28'6"	8720	28'7"	8687	28'6"
J*	3050	10'0"	2830	9'3"	3050	10'0"	2830	9'3"
K	3265	10'9"	3265	10'8"	3265	10'9"	3265	10'8"
L	2200	7'3"	2200	7'3"	1990	6'6"	1995	6'7"

*Varies with stick length.

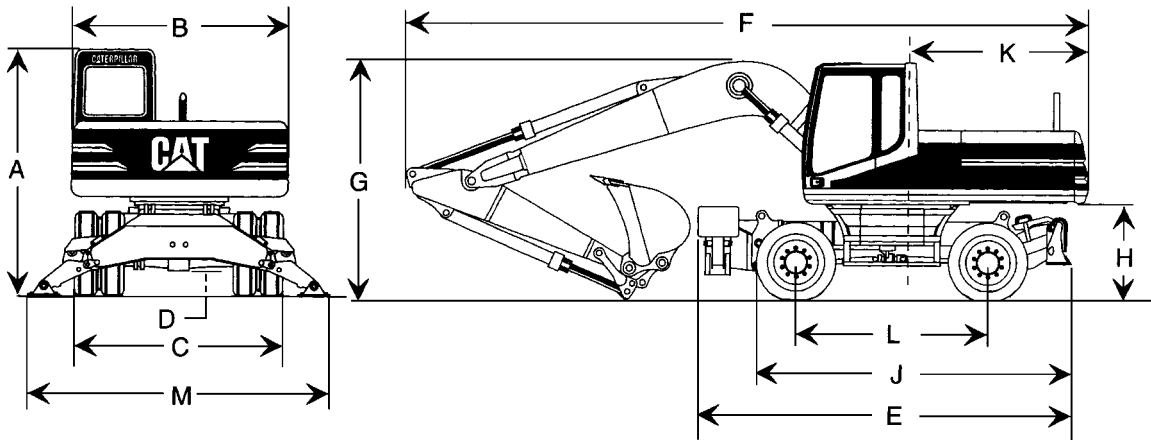

	M312		M315		M318		M320	
	mm	ft	mm	ft	mm	ft	mm	ft
A	3070	10'1"	3080	10'1"	3100	10'2"	3145	10'4"
B	2500	8'2"	2500	8'2"	2500	8'2"	2650	8'8"
C*	2500	8'2"	2500	8'2"	2500	8'2"	2750	9'0"
Dozer width	2500	8'2"	2500	8'2"	2500	8'2"	2750	9'0"
D	375	14.7"	375	14.7"	375	14.7"	360	14.2"
E¹	4900	16'1"	5000	16'5"	5000	16'5"	5175	17'0"
E²	4660	15'3"	4930	16'2"	5030	16'5"	5205	17'1"
E³	4140	13'6"	4140	13'6"	4240	13'9"	4405	14'5"
F	8620**	28'3"	8840**	29'0"	8970	29'5"	9660	31'8"
G	3070	10'1"	3080	10'1"	3100	10'2"	3145	10'4"
H	1262	4'2"	1262	4'2"	1280	4'2"	1310	4'4"
J	4140	13'7"	4140	13'7"	4240	13'11"	4405	14'5"
K	1990	6'5"	2150	7'1"	2450	8'0"	2700	8'10"
L	2500	8'2"	2500	8'2"	2600	8'6"	2750	9'0"
M	3835	12'7"	3835	12'7"	3835	12'7"	3900	12'9"

E¹ 2 Sets Outriggers.
 E² Outriggers/Dozer.
 E³ Dozer only.

*10 × 20 Dual Tires.

**Linkage over dozer.

NOTE: Shipping dimensions above are for standard machine equipped with one-piece boom and medium stick.

Excavators

- Shipping Dimensions
- 320B, 320B L, 320B N
 - Japan Sourced

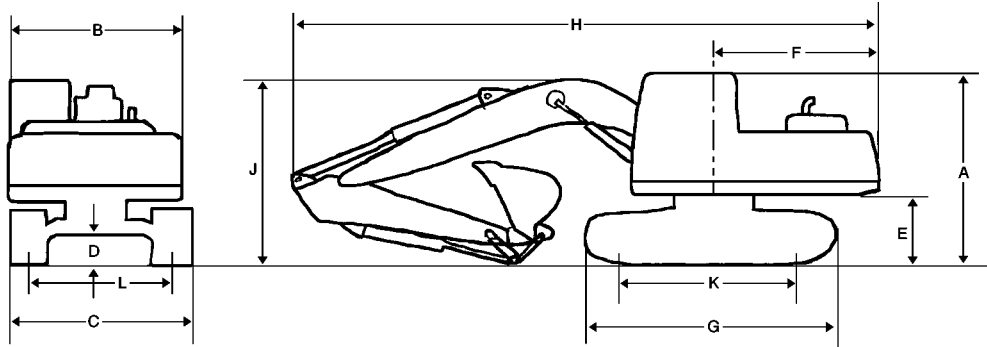

	320B Reach		320B Mass		320B L Reach		320B L Mass	
	mm	ft	mm	ft	mm	ft	mm	ft
A	2940	9'8"	2940	9'8"	2940	9'8"	2940	9'8"
B	2650	8'8"	2650	8'8"	2650	8'8"	2650	8'8"
C	2800	9'2"	2800	9'2"	3180	10'5"	3180	10'5"
D	475	1'7"	475	1'7"	475	1'7"	475	1'7"
E	1045	3'5"	1045	3'5"	1045	3'5"	1045	3'5"
F	2750	9'0"	2750	9'0"	2750	9'0"	2750	9'0"
G	4075	13'4"	4075	13'4"	4455	14'7"	4455	14'7"
H	9440	31'0"	9000	29'6"	9440	31'0"	9000	29'6"
J*	2940	9'8"	3050	10'0"	2940	9'8"	3050	10'0"
K	3265	10'9"	3265	10'9"	3650	12'0"	3650	12'0"
L	2200	7'3"	2200	7'3"	2380	7'10"	2380	7'10"

	320B N Reach		320B N Mass	
	mm	ft	mm	ft
A	2940	9'8"	2940	9'8"
B	2470	8'1"	2470	8'1"
C	2500	8'2"	2500	8'2"
D	475	1'7"	475	1'7"
E	1045	3'5"	1045	3'5"
F	2750	9'0"	2750	9'0"
G	4075	13'4"	4075	13'4"
H	10 230	33'7"	9000	29'6"
J*	2940	9'8"	3050	10'0"
K	3265	10'9"	3265	10'9"
L	2200	7'3"	2200	7'3"

*Varies with stick length.

- Shipping Dimensions
- 320B, 320B L, 320B LN, 320B S
 - Belgium Sourced

Excavators

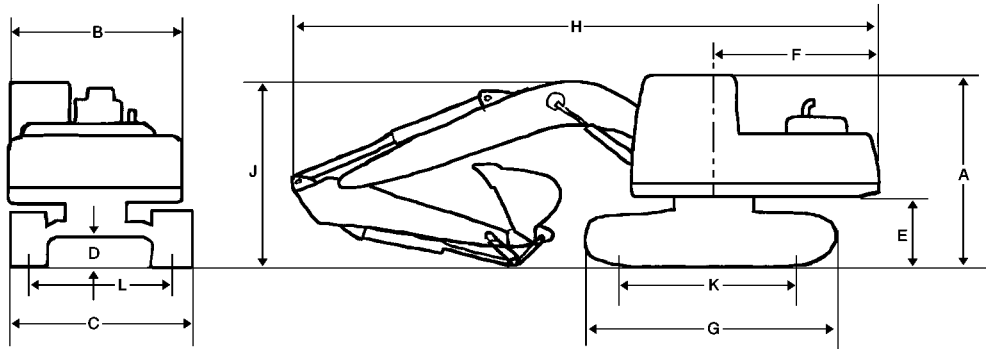

4

	320B Reach		320B Mass		320B VA		320B L Reach		320B L Mass		320B L VA	
	mm	ft	mm	ft	mm	ft	mm	ft	mm	ft	mm	ft
A	3030	9'11"	3030	9'11"	3030	9'11"	3030	9'11"	3030	9'11"	3030	9'11"
B	2490	8'2"	2490	8'2"	2490	8'2"	2490	8'2"	2490	8'2"	2490	8'2"
C	2800	9'2"	2800	9'2"	2800	9'2"	2980	9'9"	2980	9'9"	2980	9'9"
D	470	18"	470	18"	470	18"	470	18"	470	18"	470	18"
E	1020	3'4"	1020	3'4"	1020	3'4"	1020	3'4"	1020	3'4"	1020	3'4"
F	2750	9'0"	2750	9'0"	2750	9'0"	2750	9'0"	2750	9'0"	2750	9'0"
G	4075	13'4"	4075	13'4"	4075	13'4"	4455	14'7"	4455	14'7"	4455	14'7"
H	9360	30'8"	8890	29'2"	9250	30'4"	9360	30'8"	8890	29'2"	9250	30'4"
J*	2910	9'7"	2870	9'5"	2980	9'9"	2910	9'7"	2870	9'5"	2980	9'9"
K	3265	10'8"	3265	10'8"	3265	10'8"	3650	12'0"	3650	12'0"	3650	12'0"
L	2200	7'3"	2200	7'3"	2200	7'3"	2380	7'10"	2380	7'10"	2380	7'10"

	320B LN Reach		320B LN Mass		320B LN VA		320B S Reach		320B S Mass		320B S VA	
	mm	ft	mm	ft	mm	ft	mm	ft	mm	ft	mm	ft
A	3030	9'11"	3030	9'11"	3030	9'11"	3100	10'2"	3100	10'2"	3100	10'2"
B	2490	8'2"	2490	8'2"	2490	8'2"	2490	8'2"	2490	8'2"	2490	8'2"
C	2595	8'6"	2595	8'6"	2595	8'6"	2495	8'2"	2495	8'2"	2495	8'2"
D	470	18"	470	18"	470	18"	490	1'7"	490	1'7"	490	1'7"
E	1000	3'3"	1000	3'3"	1000	3'3"	1080	3'7"	1080	3'7"	1080	3'7"
F	2750	9'0"	2750	9'0"	2750	9'0"	2750	9'0"	2750	9'0"	2750	9'0"
G	4460	14'8"	4460	14'8"	4460	14'8"	4360	14'4"	4360	14'4"	4360	14'4"
H	9360	30'8"	8890	29'2"	9250	30'4"	9360	30'8"	8890	29'2"	9250	30'4"
J*	3225	10'7"	3225	10'7"	3225	10'7"	3245	10'8"	3245	10'8"	3245	10'8"
K	3650	12'0"	3650	12'0"	3650	12'0"	3490	11'5"	3490	11'5"	3490	11'5"
L	1995	6'7"	1995	6'7"	1995	6'7"	1895	6'3"	1895	6'3"	1895	6'3"

*Varies with stick length.

Excavators

Shipping Dimensions

- 322B, 322B L — Japan/U.S. Sourced
- 322B L, 322B LN — Belgium Sourced

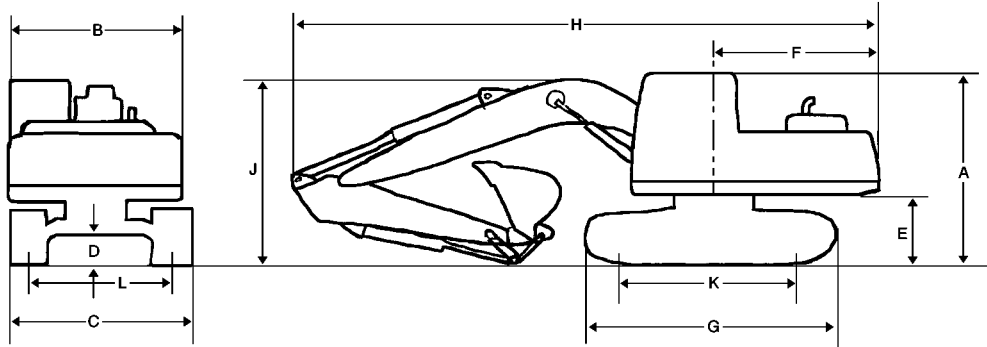

Japan/U.S. Sourced

	322B Reach		322B Mass		322B L Reach		322B L Mass	
	mm	ft	mm	ft	mm	ft	mm	ft
A	2980	9'9"	2980	9'9"	2980	9'9"	2980	9'9"
B	2740	9'0"	2740	9'0"	2740	9'0"	2740	9'0"
C	2990	9'10"	2990	9'10"	3390	11'1"	3390	11'1"
D	445	18"	445	18"	445	18"	445	18"
E	1060	3'6"	1060	3'6"	1060	3'6"	1060	3'6"
F	2900	9'6"	2900	9'6"	2900	9'6"	2900	9'6"
G	4260	14'0"	4260	14'0"	4640	15'3"	4640	15'3"
H	9960	32'8"	9490	31'2"	9960	32'8"	9490	31'2"
J*	3120	10'3"	3450	11'4"	3120	10'3"	3450	11'4"
K	3450	11'4"	3450	11'4"	3830	12'7"	3830	12'7"
L	2390	7'10"	2390	7'10"	2590	8'6"	2590	8'6"

Belgium Sourced

	322B L Reach		322B L Mass		322B L VA		322B LN Reach		322B LN Mass		322B LN VA	
	mm	ft	mm	ft	mm	ft	mm	ft	mm	ft	mm	ft
A	2980	9'9"	2980	9'9"	2980	9'9"	2980	9'9"	2980	9'9"	2980	9'9"
B	2740	9'0"	2740	9'0"	2740	9'0"	2740	9'0"	2740	9'0"	2740	9'0"
C	3390	11'2"	3390	11'2"	3390	11'2"	2990	9'10"	2990	9'10"	2990	9'10"
D	470	1'7"	470	1'7"	470	1'7"	470	1'7"	470	1'7"	470	1'7"
E	1080	3'7"	1080	3'7"	1080	3'7"	1080	3'7"	1080	3'7"	1080	3'7"
F	2855	9'4"	2855	9'4"	2855	9'4"	2855	9'4"	2855	9'4"	2855	9'4"
G	4630	15'2"	4630	15'2"	4630	15'2"	4630	15'2"	4630	15'2"	4630	15'2"
H	10 000	32'10"	9480	31'1"	9700	31'10"	10 000	32'10"	9480	31'1"	9700	31'10"
J*	3280	10'9"	3320	10'11"	3300	10'10"	3280	10'9"	3320	10'11"	3300	10'10"
K	3830	12'7"	3830	12'7"	3830	12'7"	3830	12'7"	3830	12'7"	3830	12'7"
L	2590	8'6"	2590	8'6"	2590	8'6"	2390	7'10"	2390	7'10"	2390	7'10"

*Varies with stick length.

Shipping Dimensions

- 325B, 325B L — Japan/U.S. Sourced
- 325B L, 325B LN — Belgium Sourced

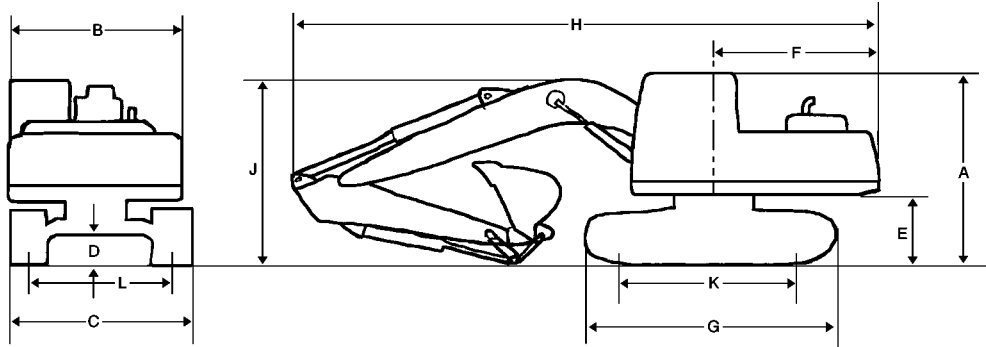

Japan/U.S. Sourced

	325B Reach		325B Mass		325B L Reach		325B L Mass	
	mm	ft	mm	ft	mm	ft	mm	ft
A	3090	10'2"	3090	10'2"	3090	10'2"	3090	10'2"
B	2900	9'6"	2900	9'6"	2900	9'6"	2900	9'6"
C	2990	9'10"	2990	9'10"	3390	11'1"	3390	11'1"
D	510	1'8"	510	1'8"	510	1'8"	510	1'8"
E	1140	3'9"	1140	3'9"	1140	3'9"	1140	3'9"
F	3050	10'0"	3050	10'0"	3050	10'0"	3050	10'0"
G	4360	14'4"	4360	14'4"	4660	15'3"	4660	15'3"
H	10 290	33'10"	9710	31'10"	10 290	33'10"	9710	31'10"
J*	3270	10'9"	3460	11'4"	3270	10'9"	3460	11'4"
K	3490	11'5"	3490	11'5"	3795	12'5"	3795	12'5"
L	2390	7'10"	2390	7'10"	2590	8'6"	2590	8'6"

Belgium Sourced

	325B L Reach		325B L Mass		325B L VA		325B LN Reach		325B LN Mass		325B LN VA	
	mm	ft	mm	ft	mm	ft	mm	ft	mm	ft	mm	ft
A	3140	10'4"	3140	10'4"	3140	10'4"	3140	10'4"	3140	10'4"	3140	10'4"
B	2900	9'6"	2900	9'6"	2900	9'6"	2900	9'6"	2900	9'6"	2900	9'6"
C	3390	11'2"	3390	11'2"	3390	11'2"	2990	9'10"	2990	9'10"	2990	9'10"
D	480	1'7"	480	1'7"	480	1'7"	480	1'7"	480	1'7"	480	1'7"
E	1130	3'9"	1130	3'9"	1130	3'9"	1130	3'9"	1130	3'9"	1130	3'9"
F	3050	10'0"	3050	10'0"	3050	10'0"	3050	10'0"	3050	10'0"	3050	10'0"
G	4660	15'4"	4660	15'4"	4660	15'4"	4660	15'3"	4660	15'3"	4660	15'3"
H	10 350	33'11"	9890	32'5"	10 090	33'1"	10 350	33'11"	9890	32'5"	10 090	33'1"
J*	3210	10'6"	3330	10'11"	3150	10'4"	3210	10'6"	3330	10'11"	3150	10'4"
K	3800	12'6"	3800	12'6"	3800	12'6"	3800	12'6"	3800	12'6"	3800	12'6"
L	2590	8'6"	2590	8'6"	2590	8'6"	2390	7'10"	2390	7'10"	2390	7'10"

*Varies with stick length.

Excavators

Shipping Dimensions

- 330B, 330B L — Japan/U.S. Sourced
- 330B L, 330B LN — Belgium Sourced

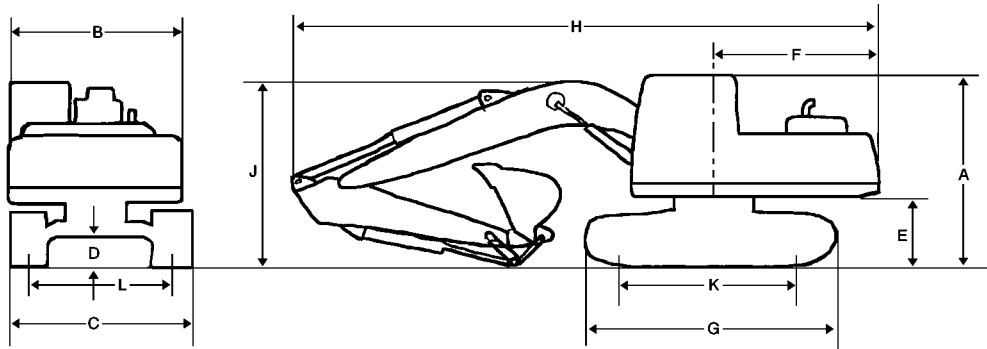

Japan/U.S. Sourced

	330B Reach		330B Mass		330B L Reach		330B L Mass	
	mm	ft	mm	ft	mm	ft	mm	ft
A	3150	10'4"	3150	10'4"	3150	10'4"	3150	10'4"
B	2990	9'10"	2990	9'10"	2990	9'10"	2990	9'10"
C	3190	10'6"	3190	10'6"	3340	10'11"	3340	10'11"
D	480	1'7"	480	1'7"	480	1'7"	480	1'7"
E	1230	4'0"	1230	4'0"	1230	4'0"	1230	4'0"
F	3500	11'6"	3500	11'6"	3500	11'6"	3500	11'6"
G	4580	15'0"	4580	15'0"	5020	16'6"	5020	16'6"
H	11 010	36'2"	10 760	35'4"	11 010	36'2"	10 760	35'4"
J*	3290	10'10"	3560	11'8"	3290	10'10"	3560	11'8"
K	3610	11'10"	3610	11'10"	4040	13'3"	4040	13'3"
L	2590	8'6"	2590	8'6"	2590	8'6"	2590	8'6"

Belgium Sourced

	330B L Reach		330B L Mass		330B LN Reach		330B LN Mass	
	mm	ft	mm	ft	mm	ft	mm	ft
A	3250	10'8"	3250	10'8"	3250	10'8"	3250	10'8"
B	3000	9'10"	3000	9'10"	3000	9'10"	3000	9'10"
C	3340	11'0"	3340	11'0"	2990	9'10"	2990	9'10"
D	510	1'8"	510	1'8"	510	1'8"	510	1'8"
E	1260	4'2"	1260	4'2"	1260	4'2"	1260	4'2"
F	3500	11'6"	3500	11'6"	3500	11'6"	3500	11'6"
G	5020	16'6"	5020	16'6"	5020	16'6"	5020	16'6"
H	11 150	36'7"	10 810	35'6"	11 150	36'7"	10 810	35'6"
J*	3560	11'8"	3580	11'9"	3560	11'8"	3580	11'9"
K	4040	13'3"	4040	13'3"	4040	13'3"	4040	13'3"
L	2590	8'6"	2590	8'6"	2390	7'10"	2390	7'10"

*Varies with stick length.

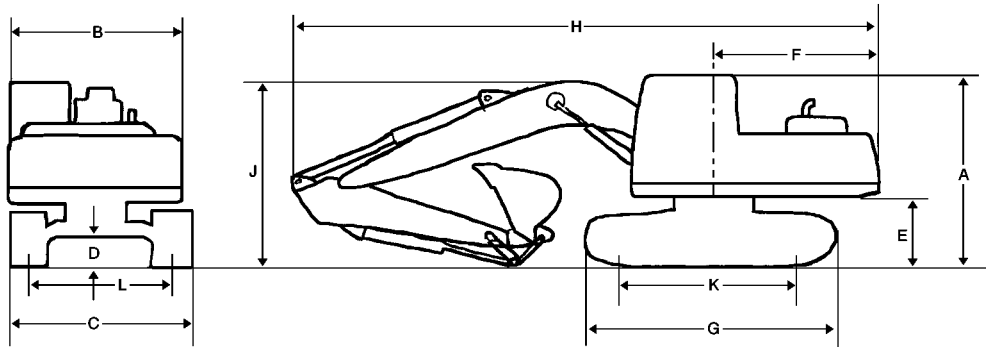

	345B Reach		345B Mass		345B L – FIX Reach		345B L – FIX Mass		345B L – VG Reach		345B L – VG Mass	
	mm	ft	mm	ft	mm	ft	mm	ft	mm	ft	mm	ft
A	3245	10'8"	3245	10'8"	3245	10'8"	3245	10'8"	3405	11'2"	3405	11'2"
B	2995	9'10"	2995	9'10"	2995	9'10"	2995	9'10"	2995	9'10"	2995	9'10"
C	3340	10'11"	3340	10'11"	3490	11'5"	3490	11'5"	2990	9'10"	2990	9'10"
D	510	1'8"	510	1'8"	510	1'8"	510	1'8"	740	2'5"	740	2'5"
E	1290	4'3"	1290	4'3"	1290	4'3"	1290	4'3"	1460	4'9"	1460	4'9"
F	3610	11'10"	3610	11'10"	3610	11'10"	3610	11'10"	3610	11'10"	3610	11'10"
G	5030	16'6"	5030	16'6"	5360	17'7"	5360	17'7"	5330	17'6"	5330	17'6"
H	11 730	38'6"	11 380	37'4"	11 770	38'7"	11 380	37'4"	11 740	38'6"	11 380	37'4"
J*	3480	11'5"	3680	12'1"	3660	12'0"	3690	12'1"	3680	12'1"	3850	12'8"
K	4030	13'3"	4030	13'3"	4360	14'4"	4360	14'4"	4340	14'3"	4340	14'3"
L	2740	9'0"	2740	9'0"	2740	9'0"	2740	9'0"	**2390	7'10"	**2390	7'10"

*Varies with stick length.

**Transport position.

NOTE: 600 mm shoes are available for 345B.
 750 mm shoes are available for 345B L.
 Medium stick is available all models.
 Undercarriage is retracted.

	350 Reach		350 Mass		350 L Reach		350 L Mass	
	mm	ft	mm	ft	mm	ft	mm	ft
A	3500	11'6"	3500	11'6"	3500	11'6"	3500	11'6"
B	3170	10'5"	3170	10'5"	3170	10'5"	3170	10'5"
C	3200	10'6"	3200	10'6"	3300	10'10"	3300	10'10"
D	730	2'5"	730	2'5"	730	2'5"	730	2'5"
E	1420	4'8"	1420	4'8"	1420	4'8"	1420	4'8"
F	3580	11'9"	3580	11'9"	3580	11'9"	3580	11'9"
G	5110	16'9"	5110	16'9"	5570	18'3"	5570	18'3"
H	12 200	40'0"	11 750	38'7"	12 200	40'0"	11 750	38'7"
J*	3750	12'4"	3980	13'1"	3750	12'4"	3980	13'1"
K	4040	13'3"	4040	13'3"	4490	14'9"	4490	14'9"
L	2550	8'4"	2550	8'4"	2550	8'4"	2550	8'4"

*Varies with stick length.

NOTE: 600 mm shoes are available for 350.
 750 mm shoes are available for 350 L.
 Medium stick is available all models.
 Undercarriage is retracted.

Excavators

Shipping Dimensions

- 375, 375 L
- Japan/U.S. Sourced ● Belgium Sourced

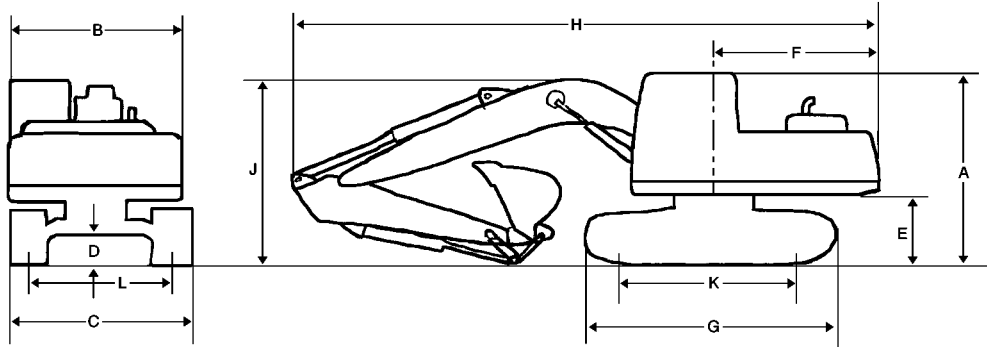

Japan/U.S. Sourced

	375 Reach		375 GP		375 Mass		375 L Reach		375 L GP		375 L Mass	
	mm	ft	mm	ft	mm	ft	mm	ft	mm	ft	mm	ft
A	3650	12'0"	3650	12'0"	3650	12'0"	3650	12'0"	3650	12'0"	3650	12'0"
B	3470	11'5"	3470	11'5"	3470	11'5"	3470	11'5"	3470	11'5"	3470	11'5"
C	3480	11'5"	3480	11'5"	3480	11'5"	3480	11'5"	3500	11'6"	3500	11'6"
D	890	2'11"	890	2'11"	890	2'11"	890	2'11"	890	2'11"	890	2'11"
E	1600	5'3"	1600	5'3"	1600	5'3"	1600	5'3"	1600	5'3"	1600	5'3"
F	4200	13'9"	4200	13'9"	4200	13'9"	4200	13'9"	4200	13'9"	4200	13'9"
G	5840	19'2"	5840	19'2"	5840	19'2"	6360	20'10"	6360	20'10"	6360	20'10"
H	14 710	48'3"	14 290	46'11"	13 140	43'1"	14 710	48'3"	14 290	46'11"	13 140	43'1"
J	4690	15'5"	5240	17'2"	4890	16'1"	4690	15'5"	5240	17'2"	4890	16'1"
K	4600	15'1"	4600	15'1"	4600	15'1"	5120	16'10"	5120	16'10"	5120	16'10"
L	2750	9'0"	2750	9'0"	2750	9'0"	2750	9'0"	2750	9'0"	2750	9'0"

NOTE: 610 mm shoes are available for 375.
 750 mm shoes are available for 375 L.
 Medium stick is available all Reach & Mass.
 3.4 m short stick is available for GP.
 Undercarriage is retracted.

Belgium Sourced

	375 Reach		375 Mass		375 L Reach		375 L Mass	
	mm	ft	mm	ft	mm	ft	mm	ft
A	3650	12'0"	3650	12'0"	3650	12'0"	3650	12'0"
B	3470	11'5"	3470	11'5"	3470	11'5"	3470	11'5"
C	3480	11'5"	3480	11'5"	3480	11'5"	3480	11'5"
D	890	2'11"	890	2'11"	890	2'11"	890	2'11"
E	1600	5'3"	1600	5'3"	1600	5'3"	1600	5'3"
F	4200	13'9"	4200	13'9"	4200	13'9"	4200	13'9"
G	5840	19'2"	5840	19'2"	6360	20'10"	6360	20'10"
H	13 140	43'1"	13 140	43'1"	14 290	46'11"	13 140	43'1"
J	5240	17'2"	4890	16'1"	5240	17'2"	4890	16'1"
K	4600	15'1"	4600	15'1"	5120	16'10"	5120	16'10"
L	2750	9'0"	2750	9'0"	2750	9'0"	2750	9'0"

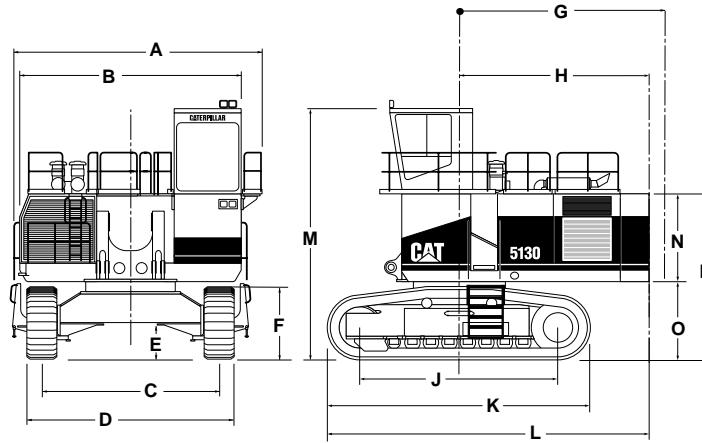

	5130B ME		5230 ME	
	mm	ft	mm	ft
A	6620	21'9"	7510	24'7"
B	5900	19'4"	6960	22'11"
C	4720	15'6"	5196	17'0"
D	5370	17'7"	6296	20'8"
E	960	3'2"	1108	3'8"
F	1890	6'3"	2260	7'5"
G Swing radius	5250	17'3"	6450	21'2"
H	5140	16'11"	6280	20'7"
J	5552	18'3"	6260	20'6"
K	7270	23'10"	8174	26'10"
L	8775	28'9"	10 325	33'10"
M	6550	21'5"	7455	24'5"
N	2350	7'9"	2850	9'4"
O	2045	6'9"	2450	8'0"
P	4395	14'5"	5300	17'5"

● **5130B ME**

	Weight		Length		Width		Height	
	kg	lb	mm	ft	mm	ft	mm	ft
Carbody	15 800	34,820	3560	11'8"	4110	13'6"	1520	5'0"
Swing Frame	22 830	50,340	7060	23'2"	2460	8'1"	2440	8'0"
Track Roller Frame (each)								
650 mm (2'2") Shoes	23 610	52,060	7140	23'5"	1500	4'11"	1910	6'3"
800 mm (2'7") Shoes	24 640	54,320	7140	23'5"	1500	4'11"	1910	6'3"
1000 mm (3'3") Shoes	25 770	56,820	7140	23'5"	1500	4'11"	1910	6'3"
Left Module	8090	17,830	5770	18'11"	2340	7'8"	2620	8'7"
Boom Cylinders	3000	6620	3840	12'7"	910	3'0"	690	2'3"
Stick Cylinders	1100	2430	3840	12'7"	910	3'0"	690	2'3"
Bucket Cylinders	1100	2430	3840	12'7"	910	3'0"	690	2'3"
Ladders	2070	4570	2240	7'4"	1090	3'7"	1190	3'11"
Parts Box	2100	4620	2240	7'4"	1090	3'7"	990	3'3"
Handrails	1150	2540	3990	13'1"	2290	7'6"	1120	3'8"
Right Module	13 810	30,440	5660	18'7"	2440	8'0"	3050	10'0"
Cab	2050	4510	2360	7'9"	2060	6'9"	3100	10'2"
Boom	20 530	45,260	8560	28'1"	1980	6'6"	3400	11'2"
Counterweight	20 970	46,220	6250	20'6"	1170	3'10"	2510	8'3"
Stick	6220	13,710	5260	17'3"	1020	3'4"	2290	7'6"
Brackets	1550	3420	1520	5'0"	1450	4'9"	790	2'7"
Bucket	9700	21,380	2900	9'6"	3200	10'6"	2820	9'3"

● **5230 ME**

	Weight		Length		Width		Height	
	kg	lb	mm	ft	mm	ft	mm	ft
Carbody	24 770	54,610	4470	14'8"	3840	12'7"	1980	6'6"
Swing Frame	40 590	89,490	8890	29'2"	3330	10'11"	3480	11'5"
Track Roller Frame (each)								
1100 mm (3'7") Shoes	45 400	100,080	8030	26'4"	1830	6'0"	2360	7'9"
1300 mm (4'3") Shoes	46 560	102,640	8030	26'4"	1830	6'0"	2360	7'9"
1500 mm (4'11") Shoes	48 080	106,000	8030	26'4"	1830	6'0"	2360	7'9"
Left Module	12 310	27,140	7190	23'7"	2510	8'3"	3230	10'7"
Cylinder Skid	3130	6900	4170	13'8"	610	2'0"	810	2'8"
Cylinder Skid	3130	6900	4170	13'8"	610	2'0"	810	2'8"
Cylinder Skid	4350	9580	4880	16'0"	910	3'0"	740	2'5"
Cylinder Skid	3290	7260	4170	13'8"	910	3'0"	740	2'5"
Parts Box	2220	4890	2240	7'4"	1090	3'7"	990	3'3"
Parts Box	2170	4780	2240	7'4"	1090	3'7"	990	3'3"
Parts Box	2220	4900	2240	7'4"	1090	3'7"	990	3'3"
Handrails	1350	2980	3990	13'1"	2290	7'6"	1120	3'8"
Right Module	20 880	46,040	7570	24'10"	2510	8'3"	3580	11'9"
Cab	2380	5240	2360	7'9"	2060	6'9"	3050	10'0"
Boom	28 340	62,480	10 030	32'11"	3960	13'0"	2490	8'2"
Counterweight	41 390	91,240	7320	24'0"	1220	4'0"	3050	10'0"
Stick	11 030	24,320	6250	20'6"	1350	4'5"	2570	8'5"
Brackets	2590	5720	1780	5'10"	1680	5'6"	890	2'11"
Guards	940	2080	2080	6'10"	1700	5'7"	840	2'9"
Bucket	16 380	36,110	4010	13'2"	3250	10'8"	3100	10'2"

Major Component Weights

● 301.5 ● 307B ● 307B SB ● 311B
● 312B ● 315B ● 315B L ● 318B L

Excavators

	301.5†		307B		307B SB		311B		312B	
Buckets: (see data in bucket section)	kg	lb	kg	lb	kg	lb	kg	lb	kg	lb
Sticks:*										
Short Stick			—	—	—	—	515	1140	560	1240
Medium Stick			245	540	150	330	500	1105	540	1200
Long Stick			325	720	230	510	600	1330	620	1370
Extra Long Stick			—	—	—	—	—	—	—	—
Booms:**										
One-piece			635	1400	590	1300	1135	2500	1230	2710
Parallel-Offset			1115	2460	—	—	—	—	—	—
VA (France sourced only)			—	—	—	—	—	—	1720	3790
Other:										
Upperstructure (complete w/o ctwt)			2550	5620	3150	6940	3870	8530	3875	8540
Standard undercarriage (std shoe)			2120	4670	2120	4670	3700	8155	3835	8455
Long undercarriage (std shoe)			—	—	—	—	—	—	4335	9555
Counterweight			750	1650	1150	2540	1450	3200	2450	5400

*Stick weights include stick, stick lines, bucket cylinder, bucket cylinder pins and bucket linkage.

**Boom weights include boom, boom lines, boom cylinders and rod end pins, stick cylinder and head end pin.

†Information unavailable.

	315B		315B L		318B L		318B L	
Source	—		France		Japan		France	
Buckets: (see data in bucket section)	kg	lb	kg	lb	kg	lb	kg	lb
Sticks:*								
Short Stick	650	1430	830	1830	820	1810	868	1913
Medium Stick	580	1280	760	1676	810	1790	878	1935
Long Stick	630	1390	810	1786	860	1900	876	1931
Extra Long Stick	700	1540	890	1962	980	2160	946	2085
Booms:**								
One-piece	1600	3500	1610	3550	1900	4190	1825	4025
Parallel-Offset	—	—	—	—	—	—	—	—
VA (France sourced only)	—	—	2310	5095	—	—	—	—
Other:								
Upperstructure (complete w/o ctwt)	4600	10,200	4600	10,200	4550	10,030	5100	11,245
Standard undercarriage (std shoe)	5300	11,600	—	—	—	—	—	—
Long undercarriage (std shoe)	5900	12,900	5900	12,900	6650	14,650	6470	14,260
Narrow undercarriage (std shoe)	—	—	—	—	6360	14,030	6190	13,650
Counterweight	3000	6600	3300	7276	3610	7960	3600	7940

*Stick weights include stick, stick lines, bucket cylinder, bucket cylinder pins and bucket linkage.

**Boom weights include boom, boom lines, boom cylinders and rod end pins, stick cylinder and head end pin.

	M312		M315		M318		M320	
Buckets: (see data in bucket section)	kg	lb	kg	lb	kg	lb	kg	lb
Sticks:*								
Short Stick	522	1151	588	1297	743	1638	936	2064
Medium Short Stick	509	1122	604	1332	795	1753	991	2185
Medium Stick	541	1193	633	1396	837	1846	1081	2384
Long Stick	596	1314	652	1438	1025	2260	1253	2763
Extra Long Stick	614	1354	761	1678	—	—	—	—
Industrial Stick	508	1120	606	1336	737	1625	—	—
Booms:**								
One-piece Boom	1208	2664	1371	3023	1737	3830	2165	4774
VA Stub Boom	867	1912	997	2198	1173	2586	1409	3107
VA Fore Boom	748	1649	885	1951	1059	2335	1329	2930
Other:								
Upperstructure (with swing bearing, no boom)	6350	14,002	7473	16,478	8590	18,941	9282	20,467
Undercarriage (with standard tires)	3390	7475	3700	8159	4070	8974	4917	10,842
Outriggers (each set, with cylinders and linkage)	800	1764	1040	2293	1070	2359	1275	2811
Dozer Blade (with cylinders and linkage)	650	1433	700	1544	700	1544	900	1985

*Stick weight includes stick, stick lines, bucket cylinder, bucket cylinder pins, bucket linkage and bucket linkage pins.

**One-piece boom weight includes boom, boom lines, boom cylinders, boom cylinder rod end pin, stick cylinder, stick cylinder head end pin and boom nose pin.

— VA stub boom weight includes stub boom, stub boom lines, boom cylinders, VA cylinder, VA cylinder head end pin and stub/fore boom pin.

— VA fore boom weight includes fore boom, fore boom lines, stick cylinder, stick cylinder head end pin, VA cylinder rod end pin and fore boom nose pin.

● 320B ● 322B ● 325B ● 330B ● 345B
● Japan/U.S. Sourced

Excavators

Source	320B		322B		325B		330B		345B	
	Japan	Japan, U.S.	Japan, U.S.	Japan, U.S.	Japan, U.S.	Japan, U.S.	Japan, U.S.	Japan, U.S.	Japan, U.S.	
Buckets: (see data in bucket section)	kg	lb	kg	lb	kg	lb	kg	lb	kg	lb
Booms:**										
One-piece Reach	2020	4450	2480	5470	2745	6050	3830	8445	4700	10,360
Sticks:* (for Reach Boom)										
Short	750	1650	760	1680	895	1980	1090	2400	1285	2830
*	675	1490	785	1730	825	1820	1130	2490	1585	3490
*	650	1430	985	2170	905	2000	1220	2690	1665	3670
*	750	1650	—	—	903	1990	1350	2980	—	—
Long	—	—	—	—	—	—	—	—	—	—
Booms:**										
One-piece Mass	2060	4540	2540	5600	2820	6220	3755	8280	4740	10,450
VA Boom	—	—	—	—	—	—	—	—	—	—
Sticks:* (for Mass Boom & VA Boom)										
Short	750	1650	880	1940	895	1980	1090	2400	1700	3750
*	780	1720	935	2060	995	2200	1180	2600	1720	3790
Long	—	—	—	—	—	—	1300	2870	—	—
Upperstructure (complete w/o ctwt)	5600	12,350	6445	14,210	7020	15,480	8830	19,470	11 310	24,930
Reinforced Frame	—	—	—	—	—	—	—	—	—	—
Undercarriage — Standard	(600) 6470	14,260	(600) 7380	16,270	(600) 8680	19,140	(600) 10 915	24,060	(600) 13 980	30,820
	(700) 6800	14,990	(700) 7640	16,845	(700) 8980	19,800	(750) 11 410	25,150	(750) 15 020	33,115
	(800) 7090	15,630	(800) 7950	17,530	(800) 9615	21,200	(850) 12 100	26,680	(900) 15 740	34,700
() Shoe width — Long (FIX)	(600) 7210	15,900	(600) 7960	17,550	(600) 9280	20,460	(600) 11 680	25,750	(600) 15 010	33,090
	(700) 7410	16,340	(700) 8250	18,180	(700) 9600	21,170	(750) 12 220	26,940	(750) 16 110	35,515
	(800) 7690	16,950	(800) 8580	18,920	(800) 10 270	22,640	(850) 12 980	28,620	(900) 16 870	37,190
— Long (VG)	—	—	—	—	—	—	—	—	(600) 16 680	36,770
	—	—	—	—	—	—	—	—	(750) 17 780	39,200
	—	—	—	—	—	—	—	—	(900) 18 640	41,095
— Narrow	(500) 6190	13,650	—	—	—	—	—	—	—	—
	(600) 6425	14,160	—	—	—	—	(600) 11 560	25,490	—	—
— Long Narrow	—	—	(600) 7950	17,530	(600) 9215	20,320	(750) 12 100	26,680	—	—
Counterweight — Standard	3860	8510	4460	9835	5220	11,500	5920	13,050	8500	18,740
— Extra	—	—	—	—	—	—	—	—	9500	20,940
— Super Long Reach	—	—	—	—	—	—	—	—	—	—
— Super Long Demo.	—	—	—	—	—	—	—	—	—	—
— Material Handling	—	—	—	—	—	—	—	—	—	—
— Ditch Cleaning	—	—	—	—	—	—	—	—	—	—

*Stick weights include stick and stick lines.

**Boom weights include boom, boom lines, boom cylinders and rod end pins, stick cylinder and head end pin.

Excavators

Major Component Weights

- 320B ● 322B ● 325B ● 330B ● 345B
- Belgium Sourced

	320B		322B		325B		330B		345B	
Buckets: (see data in bucket section)	kg	lb	kg	lb	kg	lb	kg	lb	kg	lb
Booms:**										
One-piece Reach	2060	4540	2480	5470	2480	5470	3400	7500	4610	10,165
Sticks:* (for Reach Boom)										
Short	720	1590	730	1610	840	1850	1020	2250	1670	3680
Medium	620	1370	760	1680	800	1760	1080	2380	1655	3650
Long	670	1480	—	—	870	1920	1170	2580	—	—
Extra Long	—	—	—	—	—	—	—	—	—	—
Booms:**										
One-piece Mass	2085	4600	2550	5620	2915	6430	3610	7960	5130	11,310
VA Boom	2660	5865	—	—	3540	7805	—	—	—	—
Sticks:* (for Mass Boom)										
Short	610	1345	840	1850	840	1850	1020	2250	1700	3750
Medium	750	1650	890	1960	950	2095	1110	2450	1675	3690
Upperstructure (complete w/o ctwt)	5560	12,260	6230	13,740	7320	16,140	9804	21,620	10 150	22,380
Undercarriage — Standard	6470	14,270	—	—	—	—	—	—	—	—
— L	7330	16,160	8580	18,920	10 685	23,560	12 300	27,120	18 780	41,410
— LN	6750	14,880	7910	17,440	9625	21,220	11 500	25,360	—	—
— S	7990	17,620	—	—	—	—	—	—	—	—
Counterweight — Standard	4410	9725	—	—	—	—	—	—	—	—
— L	4410	9725	4860	10,730	5210	11,490	6120	13,490	9300	20,510
— LN	4710	10,385	4860	10,730	5210	11,490	6620	14,600	—	—
— S	4710	10,385	—	—	—	—	—	—	—	—

*Stick weights include stick and stick lines.

**Boom weights include boom, boom lines, boom cylinders and rod end pins, stick cylinder and head end pin.

NOTE: Heavy duty track shoes available.

	350		375		375	
Buckets: (see data in bucket section)	kg	lb	kg	lb	kg	lb
Sourcing	Japan		Japan/U.S.		Belgium	
Booms:*						
One-piece Reach	5060	11,155	6740	14,859	10 500	23,150
Sticks:** (for Reach Boom)						
Short	1510	3330	2780	6129	4540	10,010
•	1580	3480	2870	6330	4130	9110
*	—	—	2930	6460	—	—
Long	2000	4410	3100	6834	4300	9480
Booms:*						
One-piece General Purpose	—	—	6545	14,396	—	—
Sticks:** (for General Purpose Boom)						
Short	—	—	—	—	—	—
•	—	—	2870	6330	—	—
•	—	—	2930	6460	—	—
Long	—	—	3100	6834	—	—
Booms:*						
One-piece Mass	5080	11,199	6780	14,947	10 650	23,480
Sticks:** (for Mass Boom)						
Short	1600	3530	2870	6327	4470	9860
•	1660	3660	2940	6480	4540	10,010
•	—	—	—	—	—	—
Long	1860	4100	3180	7011	4850	10,690
Upperstructure (complete w/o ctwt)	13 680	30,160	19 200	42,300	31 700	69,900
Undercarriage — Std	(600) 18 350	40,455	(610) 28 140	62,038	28 140	62,050
() Shoe width — Long	(750) 20 000	44,090	(750) 31 540	69,534	30 800	67,910
Counterweight — Std	6200	13,670	11 600	25,550	11 790	26,030
— Long	—	—	—	—	4860	10,720
— Removal C/W	6620	14,600	12 090	26,680	—	—

*Boom weights include

— 350-boom, boom lines, cylinders, rod end pins, stick cylinder and head end pin.

— 375-boom, boom lines and rod end pins.

**Stick weight includes stick and stick lines.

NOTE: Heavy duty track shoes available.

NOTE: Major component weights for 5130B ME and 5230 ME are listed in shipping dimensions in this section.

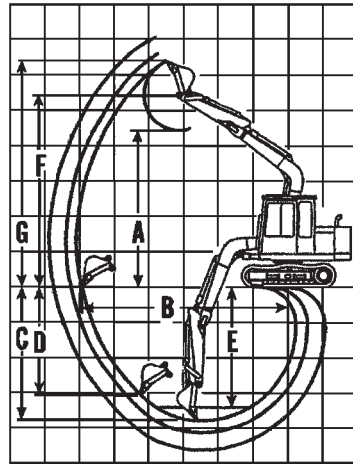

One-Piece Boom Digging Envelope

- Standard shoes and undercarriage
- Lug height not included

KEY:

- A** Maximum loading height of bucket with teeth
- B** Maximum reach at ground level
- C** Maximum digging depth
- D** Maximum vertical wall
- E** Maximum depth of cut for 2.44 m (8'0") level bottom (straight clean up)
- F** Maximum bucket hinge pin height
- G** Maximum height, to bucket teeth at highest arc

Stick	301.5		307B				307B SB			
	890 mm	2'11"	1.67 m	5'6"	2.21 m	7'3"	1.67 m	5'6"	2.21 m	7'3"
	m	ft	m	ft	m	ft	m	ft	m	ft
A	2.36	7'9"	5.15	16'11"	5.56	18'3"	4.16	13'8"	4.45	14'7"
B	3.70	12'2"	6.20	20'4"	6.72	22'1"	6.89	22'7"	7.42	24'4"
C	2.13	7'0"	4.11	13'5"	4.65	15'3"	4.16	13'8"	4.70	15'5"
D	1.62	5'4"	3.64	11'11"	4.16	13'8"	3.00	9'10"	3.58	11'9"
E	—	—	3.77	12'4"	4.35	14'3"	3.76	12'4"	4.34	14'3"
F	—	—	6.24	20'6"	6.65	21'10"	5.25	17'3"	5.54	18'2"
G	3.32	10'11"	7.29	23'11"	7.69	25'3"	6.18	20'3"	6.49	21'4"

Stick	307		311B							
	1.67 m	5'6"	2.21 m	7'3"	1.95 m	6'5"	2.25 m	7'5"	2.8 m	9'2"
	m	ft	m	ft	m	ft	m	ft	m	ft
A	5.17	17'0"	5.57	18'3"	5.30	17'5"	5.45	17'11"	5.78	19'0"
B	6.20	20'4"	6.72	22'1"	7.29	23'11"	7.57	24'10"	8.10	26'7"
C	4.10	13'5"	4.64	15'3"	4.74	15'7"	5.04	16'6"	5.59	18'4"
D	3.62	11'11"	4.14	13'7"	4.15	13'7"	4.37	14'4"	4.88	16'0"
E	3.23	10'7"	4.33	14'2"	4.42	14'6"	4.73	15'6"	5.30	17'5"
F	6.25	20'6"	6.64	21'9"	6.51	21'4"	6.66	21'10"	6.99	22'11"
G	7.30	23'11"	7.71	25'4"	7.66	25'2"	7.81	25'7"	8.13	26'8"

- 312B ● 312B L
- Japan Sourced ● France Sourced

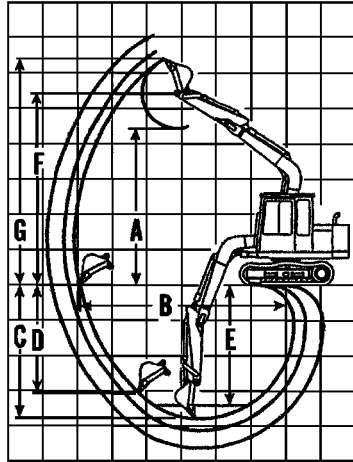

One-Piece Boom Digging Envelope

- Standard shoes and undercarriage
- Lug height not included

KEY:

- A** Maximum loading height of bucket with teeth
- B** Maximum reach at ground level
- C** Maximum digging depth
- D** Maximum vertical wall
- E** Maximum depth of cut for 2.44 m (8'0") level bottom (straight clean up)
- F** Maximum bucket hinge pin height
- G** Maximum height, to bucket teeth at highest arc

Stick	Japan Sourced		312B, 312B L		France Sourced		312B, 312B L		3 m		9'10"	
	2.1 m	6'11"	2.5 m	8'2"	3 m	9'10"	2.1 m	6'11"	2.5 m	8'2"	3 m	9'10"
	m	ft	m	ft	m	ft	m	ft	m	ft	m	ft
A	5.86	19'3"	6.11	20'1"	6.34	20'10"	5.83	19'1"	6.03	19'9"	6.31	20'8"
B	7.79	25'7"	8.17	26'10"	8.62	28'3"	7.81	25'7"	8.19	26'10"	8.64	28'4"
C	5.13	16'10"	5.53	18'2"	6.03	19'9"	5.15	16'11"	5.55	18'2"	6.05	19'10"
D	4.43	14'6"	4.89	16'1"	5.25	17'3"	4.62	15'2"	5.01	16'5"	5.52	18'1"
E	4.83	15'10"	5.24	17'2"	5.75	18'10"	4.91	16'1"	5.34	17'6"	5.87	19'3"
F	7.07	23'2"	7.32	24'0"	7.55	24'9"	7.07	23'2"	7.32	24'0"	7.56	24'9"
G	8.23	27'0"	8.48	27'10"	8.70	28'6"	8.27	27'1"	8.52	27'11"	8.75	28'8"

Excavators

Range Dimensions

- 315B ● 315B L
- Japan Sourced ● France Sourced

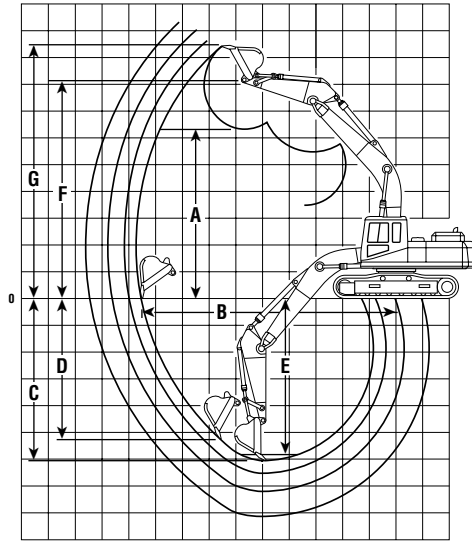

One-Piece Boom Digging Envelope

- Standard shoes and undercarriage

KEY:

- A** Maximum loading height of bucket with teeth
- B** Maximum reach at ground level
- C** Maximum digging depth
- D** Maximum vertical wall
- E** Maximum depth of cut for 2.44 m (8'0") level bottom (straight clean up)
- F** Maximum bucket hinge pin height
- G** Maximum height, to bucket teeth at highest arc

Japan Sourced

315B, 315B L

Stick	1.85 m	6'1"	2.25 m	7'5"	2.6 m	8'6"	3.1 m	10'2"
	m	ft	m	ft	m	ft	m	ft
A	5.93	19'6"	6.15	20'2"	6.32	20'9"	6.41	21'0"
B	8.04	26'5"	8.42	27'7"	8.74	28'8"	9.14	30'0"
C	5.31	17'5"	5.71	18'9"	6.06	19'10"	6.56	21'6"
D	4.40	14'5"	4.93	16'2"	5.34	17'6"	5.57	18'3"
E	5.02	16'5"	5.46	17'11"	5.83	19'1"	6.33	20'9"
F	7.27	23'10"	7.49	24'7"	7.66	25'1"	7.75	25'5"
G	8.50	27'10"	8.74	28'8"	8.91	29'3"	8.97	29'5"

France Sourced

315B L

Stick	1.85 m	6'1"	2.25 m	7'5"	2.6 m	8'6"	3.1 m	10'2"
	m	ft	m	ft	m	ft	m	ft
A	6.05	19'11"	6.07	19'11"	6.43	21'1"	6.27	20'7"
B	7.92	25'11"	8.21	26'11"	8.62	28'3"	8.90	29'2"
C	5.18	17'0"	5.58	18'3"	5.93	19'5"	6.43	21'1"
D	3.89	12'9"	4.03	13'3"	4.86	15'11"	4.68	15'4"
E	4.87	16'0"	5.27	17'3"	5.69	18'8"	6.13	20'1"
F	7.28	23'11"	7.30	23'11"	7.66	25'1"	7.50	24'7"
G	8.49	27'10"	8.51	27'11"	8.89	29'2"	8.69	28'6"

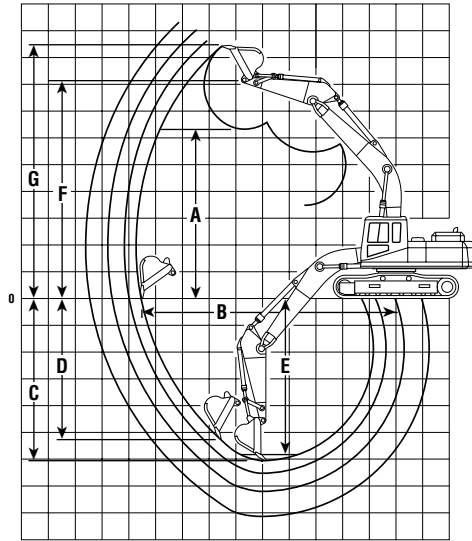

One-Piece Boom Digging Envelope

- Standard shoes and undercarriage

KEY:

- A** Maximum loading height of bucket with teeth
- B** Maximum reach at ground level
- C** Maximum digging depth
- D** Maximum vertical wall
- E** Maximum depth of cut for 2.44 m (8'0") level bottom (straight clean up)
- F** Maximum bucket hinge pin height
- G** Maximum height, to bucket teeth at highest arc

Japan Sourced

318B L, 318B LN

Stick	1.8 m		2.25 m		2.7 m		3.2 m	
	m	5'11"	m	7'5"	m	8'10"	m	10'6"
A	5.94	19'6"	6.20	20'4"	6.50	21'4"	6.85	22'6"
B	8.27	27'2"	8.71	28'7"	9.17	30'1"	9.70	31'10"
C	5.53	18'2"	5.98	19'7"	6.44	21'1"	6.93	22'9"
D	3.95	13'0"	4.96	16'3"	5.59	18'4"	6.13	20'1"
E	5.16	16'11"	5.63	18'6"	6.10	20'0"	6.76	22'2"
F	7.29	23'11"	7.57	24'10"	7.87	25'10"	8.27	27'2"
G	8.59	28'2"	8.94	29'4"	9.27	30'5"	9.68	31'9"

France Sourced

318B L, 318B LN

Stick	1.8 m		2.25 m		2.7 m		3.2 m	
	m	5'11"	m	7'5"	m	8'10"	m	10'6"
A	5.82	19'1"	6.09	20'0"	6.39	20'4"	6.33	20'9"
B	8.27	27'2"	8.71	28'7"	9.16	30'1"	9.27	30'5"
C	5.54	18'2"	5.99	19'8"	6.44	21'1"	6.83	22'5"
D	3.79	12'5"	4.81	15'9"	5.48	18'0"	3.43	11'3"
E	5.23	17'2"	5.73	18'10"	6.22	20'5"	6.52	21'5"
F	7.29	23'11"	7.57	24'10"	7.87	25'10"	7.81	25'7"
G	8.58	28'1"	8.93	29'3"	9.26	30'4"	8.86	29'1"

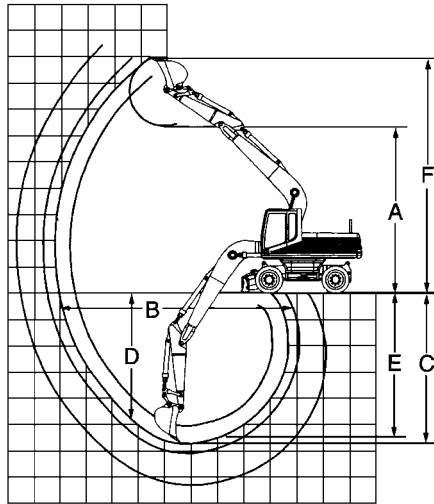

One-Piece Boom Digging Envelope

- Standard 10 × 20 tires and undercarriage
- General purpose bucket

KEY:

- A** Maximum loading height of bucket with teeth
- B** Maximum reach at ground level
- C** Maximum digging depth
- D** Maximum vertical wall
- E** Maximum depth of cut for 2.44 m (8'0") level bottom (straight clean up)
- F** Maximum height, to bucket teeth at highest arc

M312

Stick	1.6 m 5'3"		2 m 6'6"		2.3 m 7'5"		2.6 m 8'5"		3 m 9'9"	
	m	ft	m	ft	m	ft	m	ft	m	ft
A	5.64	18'5"	5.86	19'2"	6.03	19'8"	6.19	20'3"	6.20	20'3"
B	7.62	25'0"	8.01	26'3"	8.30	27'2"	8.59	28'2"	8.90	29'2"
C	4.42	14'5"	4.82	15'8"	5.12	16'8"	5.42	17'8"	5.82	19'1"
D	2.39	7'8"	3.75	12'3"	4.03	13'2"	4.30	14'1"	4.39	14'4"
E	4.10	13'5"	4.57	15'0"	4.89	16'0"	5.21	17'1"	5.63	18'5"
F	7.88	25'5"	8.21	26'9"	8.38	27'5"	8.55	28'1"	8.52	28'0"

M315

Stick	1.7 m 5'7"		2.1 m 6'9"		2.4 m 7'9"		2.6 m 8'5"		3.1 m 10'1"	
	m	ft	m	ft	m	ft	m	ft	m	ft
A	5.94	19'6"	6.16	20'3"	6.33	20'9"	6.44	21'1"	6.59	21'7"
B	7.95	26'1"	8.34	27'4"	8.63	28'4"	8.82	28'9"	9.26	30'5"
C	4.65	15'3"	5.05	16'7"	5.35	17'7"	5.55	18'2"	6.05	19'10"
D	2.51	8'3"	4.00	13'1"	4.27	14'0"	4.48	14'8"	4.76	15'7"
E	4.37	14'4"	4.81	15'9"	5.13	16'10"	5.34	17'6"	5.87	19'3"
F	8.18	26'10"	8.52	27'11"	8.69	28'6"	8.80	28'10"	8.93	29'4"

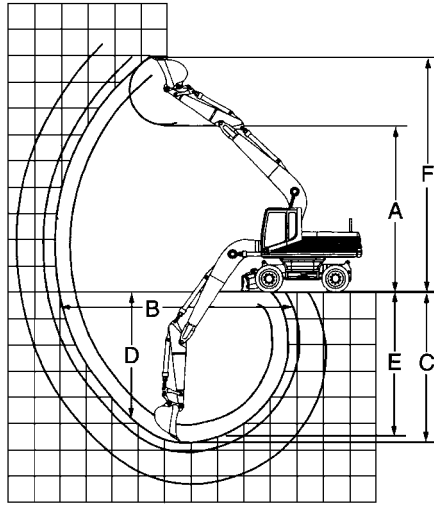

One-Piece Boom Digging Envelope

- Standard 10 × 20 tires and undercarriage
- General purpose bucket

KEY:

- A** Maximum loading height of bucket with teeth
- B** Maximum reach at ground level
- C** Maximum digging depth
- D** Maximum vertical wall
- E** Maximum depth of cut for 2.44 m (8'0") level bottom (straight clean up)
- F** Maximum height, to bucket teeth at highest arc

M318

Stick	1.8 m		2.4 m		2.8 m		4 m	
	m	ft	m	ft	m	ft	m	ft
A	6.08	19'11"	6.33	20'9"	6.42	21'1"	6.73	22'1"
B	8.49	27'10"	9.04	29'8"	9.38	30'9"	10.55	34'7"
C	5.09	16'8"	5.69	18'8"	6.09	20'0"	7.37	24'2"
D	2.93	9'7"	4.36	14'4"	4.56	15'0"	5.47	17'11"
E	4.82	15'10"	5.47	17'11"	5.89	19'4"	7.22	23'8"
F	8.53	28'0"	8.89	29'2"	8.95	29'4"	9.45	31'0"

M320

Stick	1.9 m		2.5 m		2.9 m		4.2 m	
	m	ft	m	ft	m	ft	m	ft
A	6.06	19'11"	6.30	20'8"	6.21	20'4"	6.84	22'5"
B	9.05	29'8"	9.61	31'6"	9.90	32'6"	11.18	36'8"
C	5.19	17'0"	5.79	19'0"	6.19	20'4"	7.47	24'6"
D	2.46	8'1"	3.91	12'10"	3.67	12'0"	5.34	17'6"
E	4.94	16'2"	5.58	18'4"	6.00	19'8"	7.35	24'1"
F	8.62	28'3"	8.97	29'5"	8.80	28'10"	9.50	31'2"

Excavators

Range Dimensions

- 320B ● 320B L ● 320B N
- Japan Sourced

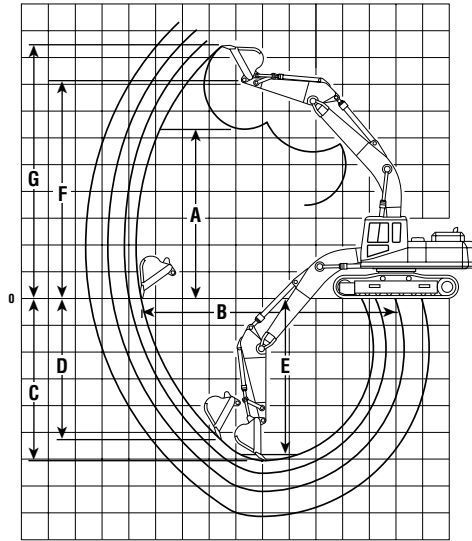

One-Piece Boom Digging Envelope

- Standard shoes and undercarriage

KEY:

- A** Maximum loading height of bucket with teeth
- B** Maximum reach at ground level
- C** Maximum digging depth
- D** Maximum vertical wall
- E** Maximum depth of cut for 2.44 m (8'0") level bottom (straight clean up)
- F** Maximum bucket hinge pin height
- G** Maximum height, to bucket teeth at highest arc

320B, 320B L, 320B N with Reach Boom

Stick	3.86 m	12'8"	2.92 m	9'7"	2.5 m	8'2"	1.9 m	6'3"
	m	ft	m	ft	m	ft	m	ft
A	6.93	22'9"	6.57	21'5"	6.46	21'2"	5.96	19'7"
B	10.63	34'11"	9.78	32'1"	9.31	30'7"	8.76	28'9"
C	7.58	24'10"	6.64	21'9"	6.15	20'2"	5.63	12'6"
D	6.80	22'4"	6.04	19'10"	5.33	17'6"	4.68	15'4"
E	7.25	23'9"	6.38	20'11"	5.85	19'2"	5.31	17'5"
F	8.41	27'7"	8.06	26'5"	7.87	25'10"	7.45	24'5"
G	9.73	31'11"	9.47	31'1"	9.16	30'1"	8.78	28'10"

320B, 320B L, 320B N with Mass Boom

Stick	2.4 m	7'10"	1.9 m	6'3"
	m	ft	m	ft
A	5.92	19'5"	5.69	18'8"
B	8.76	28'9"	8.30	27'3"
C	5.70	18'8"	5.20	17'1"
D	4.91	16'1"	4.43	14'6"
E	5.39	17'8"	4.88	16'0"
F	7.42	24'4"	7.18	23'7"
G	8.77	28'9"	8.54	28'0"

- 320B
- 320B L
- 320B N
- 320B LN
- 320B S
- Belgium Sourced

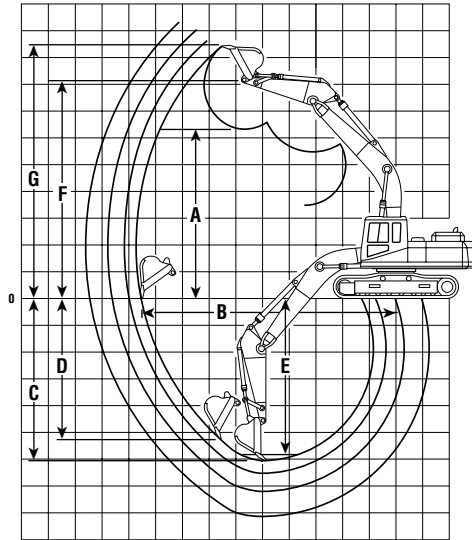

One-Piece Boom Digging Envelope

- Standard shoes and undercarriage

KEY:

- A** Maximum loading height of bucket with teeth
- B** Maximum reach at ground level
- C** Maximum digging depth
- D** Maximum vertical wall
- E** Maximum depth of cut for 2.44 m (8'0") level bottom (straight clean up)
- F** Maximum bucket hinge pin height
- G** Maximum height, to bucket teeth at highest arc

320B, 320B L, 320B N with Reach Boom

320B, 320B L, 320B N with Mass Boom

Stick	2.92 m 9'7"		2.5 m 8'2"		1.9 m 6'3"		2.4 m 7'10"		1.9 m 6'3"	
	m	ft	m	ft	m	ft	m	ft	m	ft
A	6.66	21'10"	6.46	21'2"	5.89	19'4"	5.85	19'2"	5.63	18'6"
B	9.69	31'9"	9.29	30'6"	8.82	28'11"	8.82	28'11"	8.35	27'5"
C	6.65	21'10"	6.14	20'2"	5.68	18'8"	5.75	18'10"	5.25	17'3"
D	5.45	17'11"	5.15	16'11"	3.57	12'1"	3.87	12'8"	3.43	11'3"
E	6.37	20'11"	5.94	19'6"	5.42	17'9"	8.84	29'0"	5.01	16'5"
F	—	—	—	—	—	—	—	—	—	—
G	9.39	30'10"	9.20	30'2"	8.76	28'9"	8.52	27'11"	8.75	28'8"

320B, 320B L, 320B LN with VA Boom

320B S with Mass Boom

Stick	2.4 m 7'10"		1.9 m 6'3"		2.4 m 7'10"		1.9 m 6'3"	
	m	ft	m	ft	m	ft	m	ft
A	7.50	24'7"	7.10	23'4"	5.94	19'6"	5.70	18'8"
B	9.19	30'2"	8.74	28'8"	8.80	28'10"	8.34	27'4"
C	5.69	18'8"	5.19	17'0"	5.68	18'8"	5.18	17'0"
D	3.95	13'0"	3.50	11'6"	3.80	12'6"	3.35	11'0"
E	5.58	18'4"	5.06	16'7"	5.47	17'11"	4.93	16'2"
F	—	—	—	—	—	—	—	—
G	8.75	28'8"	8.53	28'0"	8.83	29'0"	8.60	28'3"

Excavators

Range Dimensions

- 320B S ● 322B ● 322B L
- Belgium Sourced ● Japan/U.S. Sourced

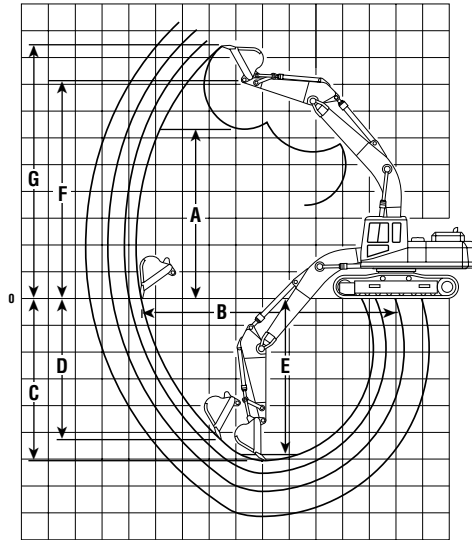

One-Piece Boom Digging Envelope

- Standard shoes and undercarriage

KEY:

- A** Maximum loading height of bucket with teeth
- B** Maximum reach at ground level
- C** Maximum digging depth
- D** Maximum vertical wall
- E** Maximum depth of cut for 2.44 m (8'0") level bottom (straight clean up)
- F** Maximum bucket hinge pin height
- G** Maximum height, to bucket teeth at highest arc

Belgium Sourced 320B S with 5.675 m (18'7") Reach Boom

Stick	2.92 m		9'7"		2.5 m		8'2"		1.9 m		6'3"	
	m	ft	m	ft	m	ft	m	ft	m	ft		
A	6.74	22'1"	6.54	21'2"	5.97	19'7"						
B	9.68	31'9"	9.28	30'5"	8.80	28'10"						
C	6.49	21'4"	6.06	19'7"	5.61	18'5"						
D	5.48	18'0"	5.08	16'8"	3.50	11'6"						
E	6.30	20'8"	5.86	19'3"	5.35	17'7"						
F	—	—	—	—	—	—						
G	9.47	31'1"	9.28	30'5"	8.84	29'0"						

Japan/U.S. Sourced 322B, 322B L with Reach Boom

Stick	3.6 m		11'10"		2.95 m		9'8"		2.5 m		8'2"	
	m	ft	m	ft	m	ft	m	ft	m	ft		
A	7.10	23'4"	6.73	22'1"	6.54	21'5"						
B	10.47	34'4"	10.01	32'10"	9.59	31'6"						
C	7.22	23'8"	6.71	22'0"	6.26	20'6"						
D	6.33	20'9"	5.70	18'8"	5.26	17'3"						
E	6.91	22'8"	6.40	21'0"	5.95	19'6"						
F	8.56	28'1"	8.28	27'2"	8.08	26'6"						
G	9.83	32'3"	9.68	31'9"	9.48	31'1"						

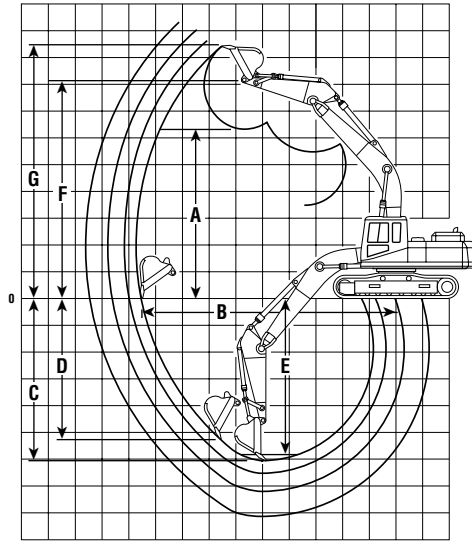

One-Piece Boom Digging Envelope

- Standard shoes and undercarriage

KEY:

- A** Maximum loading height of bucket with teeth
- B** Maximum reach at ground level
- C** Maximum digging depth
- D** Maximum vertical wall
- E** Maximum depth of cut for 2.44 m (8'0") level bottom (straight clean up)
- F** Maximum bucket hinge pin height
- G** Maximum height, to bucket teeth at highest arc

		322B, 322B L with Mass Boom			
Japan/U.S. Sourced		2.5 m		2 m	
Stick		8'2"	6'7"		
		m	ft	m	ft
A		5.98	19'7"	5.75	18'10"
B		9.12	29'11"	8.65	28'5"
C		5.91	19'5"	5.41	17'9"
D		5.18	17'0"	4.70	15'5"
E		5.57	18'3"	5.06	16'7"
F		7.63	25'0"	7.41	24'4"
G		9.16	30'1"	8.93	29'4"

		322B L, 322B LN with 5.9 m (19'4") Reach Boom				322B L, 322B LN with 5.3 m (17'5") Mass Boom			
Belgium Sourced		2.95 m		2.5 m		2.5 m		2 m	
Stick		9'8"	8'2"	8'2"	6'7"				
		m	ft	m	ft	m	ft	m	ft
A		6.75	22'2"	6.55	21'6"	5.96	19'7"	5.74	18'10"
B		10.00	32'10"	9.59	31'6"	9.12	29'11"	8.65	28'5"
C		6.69	21'11"	6.24	20'6"	5.92	19'5"	5.42	17'9"
D		4.43	14'6"	4.02	13'2"	4.09	13'5"	3.65	12'0"
E		6.50	21'4"	6.03	19'9"	5.72	18'9"	5.19	17'0"
F		—	—	—	—	—	—	—	—
G		9.62	31'7"	9.42	30'11"	9.08	29'9"	8.86	29'1"

Excavators

Range Dimensions

- 322B L ● 322B LN ● 325B ● 325B L
- Belgium Sourced ● Japan/U.S. Sourced

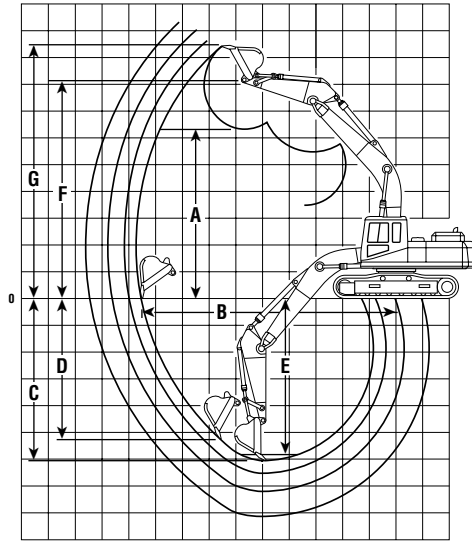

One-Piece Boom Digging Envelope

- Standard shoes and undercarriage

KEY:

- A** Maximum loading height of bucket with teeth
- B** Maximum reach at ground level
- C** Maximum digging depth
- D** Maximum vertical wall
- E** Maximum depth of cut for 2.44 m (8'0") level bottom (straight clean up)
- F** Maximum bucket hinge pin height
- G** Maximum height, to bucket teeth at highest arc

322B L, 322B LN with Belgium Sourced 5.66 m (18'7") VA Boom

Stick	2.5 m		8'2"		2 m		6'7"	
	m	ft	m	ft	m	ft	m	ft
A	7.81	25'7"	7.40	24'3"				
B	9.60	31'6"	9.13	29'11"				
C	5.89	19'4"	5.40	17'9"				
D	4.20	13'9"	3.74	12'3"				
E	5.78	19'0"	5.28	17'4"				
F	—	—	—	—				
G	11.10	36'5"	10.69	35'1"				

325B, 325B L with Japan/U.S. Sourced with Reach Boom

Stick	3.2 m		10'6"		2.65 m		8'8"		2 m		6'7"	
	m	ft	m	ft	m	ft	m	ft	m	ft	m	ft
A	7.11	23'4"	6.90	22'8"	6.31	20'8"						
B	10.52	34'6"	10.01	32'10"	9.52	31'3"						
C	7.09	23'3"	6.54	21'5"	6.06	19'11"						
D	6.38	20'11"	5.86	19'3"	5.27	17'3"						
E	6.92	22'8"	6.35	20'10"	5.83	19'2"						
F	8.60	28'3"	8.38	27'6"	7.97	26'2"						
G	9.96	32'8"	9.75	32'0"	9.46	31'0"						

325B, 325B L with Mass Boom

Stick	2.5 m		8'2"		2 m		6'7"	
	m	ft	m	ft	m	ft	m	ft
A	6.10	20'0"	5.89	19'4"				
B	9.35	30'8"	8.89	29'2"				
C	6.01	19'9"	5.51	18'1"				
D	5.21	17'1"	4.05	13'3"				
E	5.81	19'1"	5.28	17'4"				
F	7.76	25'6"	7.55	24'9"				
G	9.24	30'4"	8.93	29'4"				

- Range Dimensions
- 325B L ● 325B LN
- Belgium Sourced

Excavators

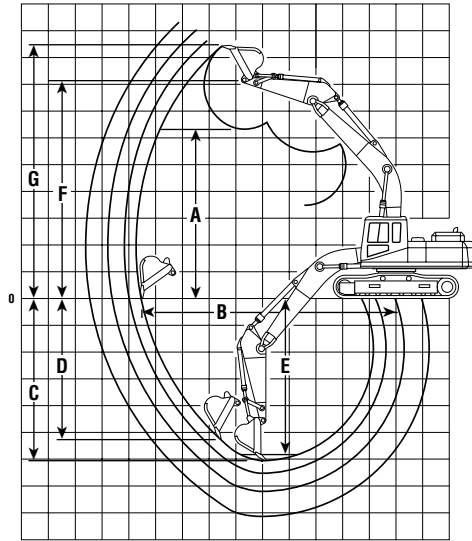

One-Piece Boom Digging Envelope

- Standard shoes and undercarriage

KEY:

- A** Maximum loading height of bucket with teeth
- B** Maximum reach at ground level
- C** Maximum digging depth
- D** Maximum vertical wall
- E** Maximum depth of cut for 2.44 m (8'0") level bottom (straight clean up)
- F** Maximum bucket hinge pin height
- G** Maximum height, to bucket teeth at highest arc

4

325B L, 325B LN with 6.15 m (20'2") Reach Boom

Stick	3.2 m		2.65 m		2 m		2.5 m		2 m	
	m	ft	m	ft	m	ft	m	ft	m	ft
A	7.05	23'2"	6.84	22'5"	6.31	20'8"	6.09	20'0"	5.89	19'4"
B	10.57	34'8"	10.07	33'0"	9.53	31'3"	9.35	30'8"	8.89	29'2"
C	7.15	23'5"	6.59	21'7"	6.06	19'11"	6.02	19'9"	5.52	18'1"
D	5.18	17'0"	4.78	15'8"	4.13	13'7"	4.11	15'6"	3.65	12'0"
E	6.98	22'11"	6.40	21'1"	5.83	19'2"	5.82	19'1"	5.29	17'4"
F	—	—	—	—	—	—	—	—	—	—
G	9.95	32'8"	9.75	32'0"	9.39	30'10"	9.17	30'1"	8.97	29'5"

325B L, 325B LN with 5.66 m (18'7") VA Boom

Stick	2.5 m		2 m	
	m	ft	m	ft
A	7.89	25'11"	7.51	24'8"
B	9.75	32'0"	9.28	30'5"
C	5.89	19'4"	5.40	17'9"
D	4.13	13'7"	3.67	12'0"
E	5.78	19'0"	5.28	17'4"
F	—	—	—	—
G	11.21	36'9"	10.83	35'6"

Excavators

Range Dimensions

- 330B ● 330B L ● 330B LN
- Japan/U.S. Sourced ● Belgium Sourced

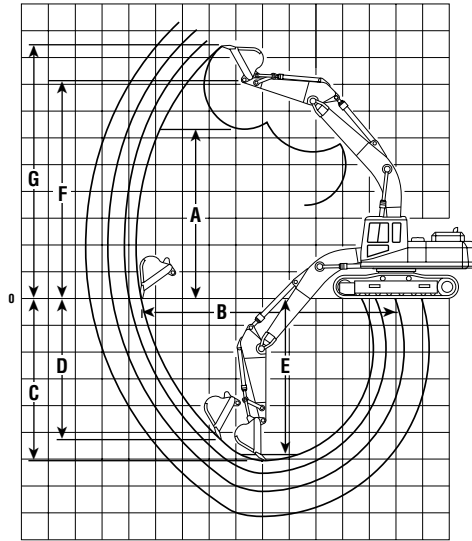

One-Piece Boom Digging Envelope

- Standard shoes and undercarriage

KEY:

- A** Maximum loading height of bucket with teeth
- B** Maximum reach at ground level
- C** Maximum digging depth
- D** Maximum vertical wall
- E** Maximum depth of cut for 2.44 m (8'0") level bottom (straight clean up)
- F** Maximum bucket hinge pin height
- G** Maximum height, to bucket teeth at highest arc

Japan/U.S. Sourced			330B, 330B L with Reach Boom				330B, 330B L with Mass Boom					
Stick	3.99 m	12'10"	3.3 m	10'10"	2.8 m	9'2"	2.15 m	7'1"	2.55 m	8'4"	2.15 m	7'1"
	m	ft	m	ft	m	ft	m	ft	m	ft	m	ft
A	7.60	24'11"	7.29	23'11"	7.12	23'4"	6.50	21'4"	6.68	21'11"	6.25	20'6"
B	11.62	38'1"	11.03	36'2"	10.58	34'9"	10.09	33'1"	10.21	33'6"	9.71	31'10"
C	8.08	26'6"	7.49	24'7"	6.99	22'11"	6.52	21'5"	6.59	21'7"	6.19	20'4"
D	7.23	23'9"	6.54	22'5"	6.12	20'1"	5.14	16'10"	5.89	19'4"	4.75	15'7"
E	7.75	25'5"	7.15	23'5"	6.65	21'10"	6.13	20'1"	6.20	20'4"	5.80	19'0"
F	9.29	30'6"	8.98	29'5"	8.80	28'10"	8.37	27'6"	8.54	27'9"	8.12	26'8"
G	10.77	35'4"	10.44	34'3"	10.27	33'8"	9.90	32'6"	10.17	33'4"	9.65	31'8"

Belgium Sourced			330B L, 330B LN with Reach Boom				330B L, 330B LN with Mass Boom					
Stick	3.9 m	12'10"	3.3 m	10'10"	2.8 m	9'2"	2.2 m	7'3"	2.6 m	8'6"	2.2 m	7'3"
	m	ft	m	ft	m	ft	m	ft	m	ft	m	ft
A	7.63	25'0"	7.31	24'0"	7.13	23'5"	6.59	21'7"	6.76	22'2"	6.34	20'10"
B	11.62	38'1"	11.03	36'2"	10.57	34'8"	10.01	32'10"	10.14	33'3"	9.64	31'8"
C	8.06	25'7"	7.46	24'6"	6.96	22'10"	6.42	21'1"	6.50	21'4"	6.10	20'0"
D	6.02	19'9"	5.36	17'7"	4.98	16'4"	4.82	15'10"	5.38	17'8"	4.38	14'4"
E	7.96	26'1"	7.32	24'0"	6.77	22'3"	6.19	20'3"	6.32	20'9"	5.86	19'3"
F	—	—	—	—	—	—	—	—	—	—	—	—
G	10.73	35'2"	10.40	34'1"	10.23	33'7"	9.91	32'6"	10.17	33'4"	9.64	31'8"

Range Dimensions
 ● 345B — Japan Sourced
 ● 345B L – FIX — Japan/U.S. Sourced

Excavators

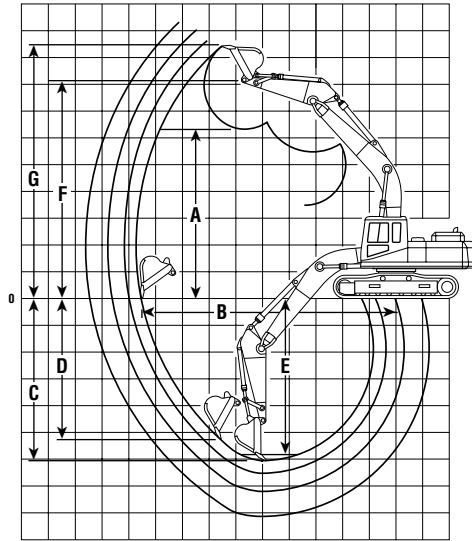

One-Piece Boom Digging Envelope

- Standard shoes and undercarriage

KEY:

- A** Maximum loading height of bucket with teeth
- B** Maximum reach at ground level
- C** Maximum digging depth
- D** Maximum vertical wall
- E** Maximum depth of cut for 2.44 m (8'0") level bottom (straight clean up)
- F** Maximum bucket hinge pin height
- G** Maximum height, to bucket teeth at highest arc

Japan Sourced

345B with Reach Boom

345B with Mass Boom

Stick	3.9 m		3.35 m		2.9 m		3 m		2.5 m	
	m	ft	m	ft	m	ft	m	ft	m	ft
A	2.12	6'11"	2.78	9'1"	3.18	10'5"	2.79	9'2"	3.19	10'6"
B	12.20	40'1"	11.66	38'3"	11.29	37'0"	11.02	36'2"	10.66	35'0"
C	8.28	27'2"	7.63	25'0"	7.23	23'9"	7.08	23'2"	6.68	21'11"
D	6.52	21'5"	6.56	21'6"	5.73	18'10"	5.63	18'6"	4.99	16'4"
E	7.88	25'10"	7.22	23'8"	6.83	22'5"	6.63	21'9"	6.25	20'6"
F	9.28	30'5"	9.24	30'4"	9.07	29'9"	8.81	28'11"	8.62	28'3"
G	10.82	35'6"	10.78	35'4"	10.60	34'9"	10.27	33'8"	10.16	33'4"

Japan/U.S. Sourced

345B L – FIX with Reach Boom

345B L – FIX with Mass Boom

Stick	3.9 m		3.35 m		2.9 m		3 m		2.5 m	
	m	ft	m	ft	m	ft	m	ft	m	ft
A	7.35	24'1"	7.37	24'2"	7.20	23'7"	6.95	22'10"	6.66	21'10"
B	12.20	40'0"	11.71	38'5"	11.29	37'0"	11.02	36'2"	10.66	35'0"
C	8.28	27'2"	7.68	25'2"	7.23	23'9"	7.08	23'3"	6.68	21'11"
D	6.52	21'5"	6.18	20'3"	5.73	18'10"	5.63	18'6"	4.99	16'4"
E	7.88	25'10"	7.28	23'11"	6.83	22'5"	6.63	21'9"	6.25	20'6"
F	9.28	30'5"	9.24	30'4"	9.07	29'9"	8.81	28'11"	8.62	28'3"
G	10.82	35'6"	10.78	35'4"	10.60	34'9"	10.27	33'8"	10.16	33'4"

Excavators

Range Dimensions

- 345B L – VG ● 345B – VG
- U.S. Sourced ● Belgium Sourced

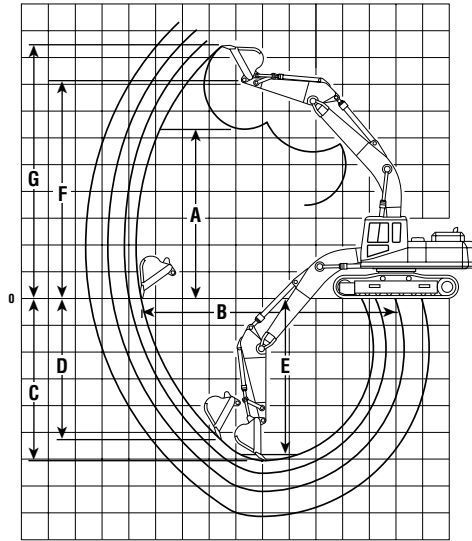

One-Piece Boom Digging Envelope

- Standard shoes and undercarriage

KEY:

- A** Maximum loading height of bucket with teeth
- B** Maximum reach at ground level
- C** Maximum digging depth
- D** Maximum vertical wall
- E** Maximum depth of cut for 2.44 m (8'0") level bottom (straight clean up)
- F** Maximum bucket hinge pin height
- G** Maximum height, to bucket teeth at highest arc

U.S. Sourced	345B L – VG with Reach Boom						345B L – VG with Mass Boom				
	Stick	3.9 m	12'10"	3.35 m	11'0"	2.9 m	9'6"	3 m	9'11"	2.5 m	8'2"
		m	ft	m	ft	m	ft	m	ft	m	ft
A		7.51	24'8"	7.54	24'9"	7.36	24'2"	7.01	23'0"	6.82	22'5"
B		12.17	39'11"	11.68	38'4"	11.26	36'11"	11.09	36'5"	11.62	38'1"
C		8.12	26'8"	7.51	24'8"	7.06	23'2"	7.02	23'0"	6.52	21'5"
D		6.36	20'10"	6.02	19'9"	5.56	18'3"	5.29	17'4"	4.07	13'4"
E		7.72	25'4"	7.12	23'4"	6.67	21'11"	6.59	21'7"	6.09	20'0"
F		9.44	31'0"	9.41	30'10"	9.23	30'3"	8.97	29'5"	8.78	28'10"
G		10.98	36'0"	10.94	35'11"	10.76	35'4"	10.51	34'6"	10.18	33'5"

Belgium Sourced	345B – VG with Reach Boom				345B – VG with Mass Boom				
	Stick	3.35 m	11'0"	2.9 m	9'6"	3 m	9'11"	2.5 m	8'2"
		m	ft	m	ft	m	ft	m	ft
A		7.54	24'9"	7.37	24'2"	6.98	22'11"	6.79	22'3"
B		11.67	38'3"	11.25	36'11"	11.12	36'6"	10.66	35'0"
C		7.50	24'7"	7.05	23'2"	7.05	23'2"	6.55	21'6"
D		6.15	20'2"	5.70	18'8"	4.95	16'3"	4.52	14'10"
E		7.34	24'1"	6.89	22'7"	6.90	22'8"	6.37	20'11"
F		—	—	—	—	—	—	—	—
G		11.04	36'3"	10.87	35'8"	10.51	34'6"	10.18	33'5"

- 350 ● 350 L
- Japan Sourced

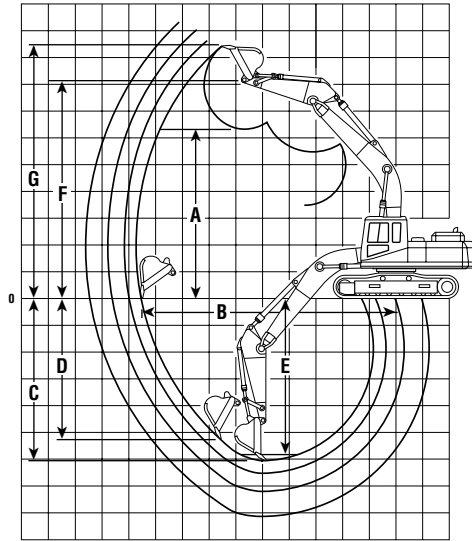

One-Piece Boom Digging Envelope

- Standard shoes and undercarriage
- Lug height not included

KEY:

- A** Maximum loading height of bucket with teeth
- B** Maximum reach at ground level
- C** Maximum digging depth
- D** Maximum vertical wall
- E** Maximum depth of cut for 2.44 m (8'0") level bottom (straight clean up)
- F** Maximum bucket hinge pin height
- G** Maximum height, to bucket teeth at highest arc

350, 350 L with Reach Boom

350, 350 L with Mass Boom

Stick	4.8 m 15'9"		3.6 m 11'10"		3.1 m 10'2"		3.7 m 12'2"		2.95 m 9'8"		2.4 m 7'10"	
	m	ft	m	ft	m	ft	m	ft	m	ft	m	ft
A	8.45	27'9"	7.99	26'3"	7.85	25'9"	7.96	26'1"	7.40	24'3"	7.06	23'2"
B	13.45	44'2"	12.33	40'5"	11.81	38'9"	11.93	39'2"	11.25	36'11"	10.68	35'0"
C	9.57	31'5"	8.37	27'6"	7.82	25'8"	7.96	26'1"	7.30	23'11"	6.75	22'2"
D	8.20	26'11"	7.11	23'4"	6.67	21'11"	6.99	22'11"	6.19	20'4"	5.42	17'9"
E	9.18	30'1"	7.98	26'2"	7.42	24'4"	7.57	24'10"	6.87	22'6"	6.32	20'9"
F	10.38	34'1"	9.92	32'7"	9.72	31'11"	9.83	32'3"	9.35	30'8"	9.01	29'7"
G	12.07	39'7"	11.62	38'1"	11.38	37'4"	11.52	37'10"	11.08	36'4"	10.70	35'1"

Excavators

Range Dimensions

- 375 ● 375 L
- Japan/U.S. Sourced

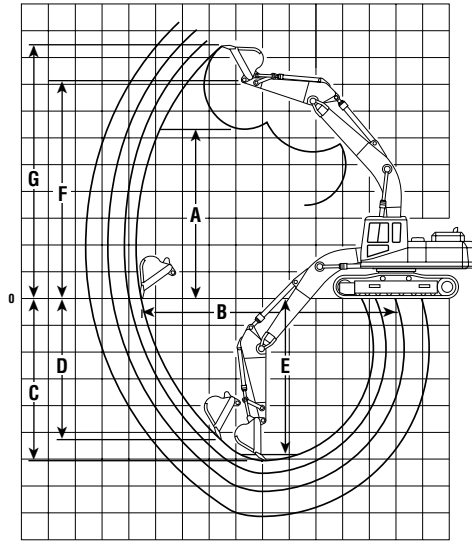

One-Piece Boom Digging Envelope

- Standard shoes and undercarriage
- Lug height not included

KEY:

- A** Maximum loading height of bucket with teeth
- B** Maximum reach at ground level
- C** Maximum digging depth
- D** Maximum vertical wall
- E** Maximum depth of cut for 2.44 m (8'0") level bottom (straight clean up)
- F** Maximum bucket hinge pin height
- G** Maximum height, to bucket teeth at highest arc

375, 375 L with Reach Boom

375, 375 L with GP Boom

Stick	5.5 m 18'1"		4.4 m 14'5"		3.4 m 11'2"		2.9 m 9'6"		5.5 m 18'1"		4.4 m 14'5"	
	m	ft	m	ft	m	ft	m	ft	m	ft	m	ft
A	10.35	33'11"	9.66	31'8"	9.44	31'0"	9.28	30'5"	10.31	33'10"	9.55	31'4"
B	15.96	52'4"	14.66	48'1"	14.02	46'0"	13.59	44'7"	15.67	51'5"	14.37	47'2"
C	10.84	35'7"	9.63	31'7"	8.77	28'9"	8.29	27'2"	10.58	34'9"	9.37	30'9"
D	9.81	32'2"	8.26	27'1"	7.70	25'3"	7.32	24'0"	9.55	31'4"	8.39	27'6"
E	10.36	34'0"	9.16	30'1"	8.24	27'0"	7.77	25'6"	10.09	33'1"	8.90	29'2"
F	12.56	41'2"	11.76	38'7"	11.68	38'4"	11.51	37'9"	12.52	41'1"	11.65	38'3"
G	14.50	47'2"	13.52	44'4"	13.58	44'7"	13.43	44'1"	14.52	47'8"	13.48	44'3"

375, 375 L with GP Boom

375, 375 L with Mass Boom

Stick	3.4 m 11'2"		4.1 m 13'5"		3.4 m 11'2"		2.9 m 9'6"	
	m	ft	m	ft	m	ft	m	ft
A	9.27	30'5"	8.76	28'9"	8.43	27'8"	8.26	27'1"
B	13.69	44'11"	13.08	42'11"	12.42	40'9"	12.00	39'4"
C	8.50	27'11"	8.11	26'7"	7.41	24'4"	6.94	22'9"
D	7.55	24'9"	7.13	23'5"	6.46	21'2"	5.52	18'1"
E	7.98	26'2"	7.59	24'11"	6.89	22'7"	6.41	21'1"
F	11.51	37'9"	11.00	36'1"	10.67	35'8"	10.49	34'5"
G	13.48	44'3"	12.95	42'6"	12.61	41'4"	12.34	40'6"

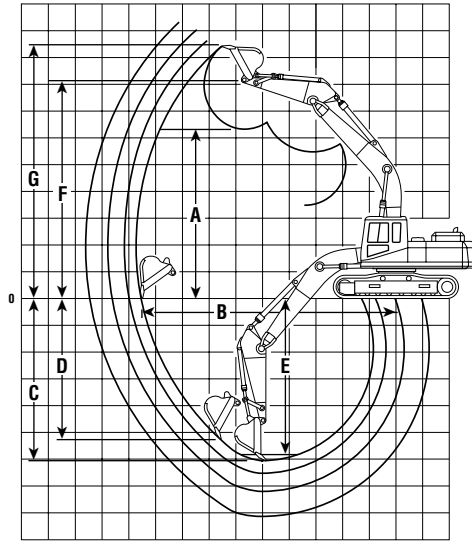

**One-Piece Boom
Digging Envelope**

- Standard shoes and undercarriage
- Lug height not included

KEY:

- A** Maximum loading height of bucket with teeth
- B** Maximum reach at ground level
- C** Maximum digging depth
- D** Maximum vertical wall
- E** Maximum depth of cut for 2.44 m (8'0") level bottom (straight clean up)
- F** Maximum bucket hinge pin height
- G** Maximum height, to bucket teeth at highest arc

375, 375 L with GP Boom

375, 375 L with Mass Boom

Stick	5.5 m 18'1"		4.4 m 14'5"		3.4 m 11'2"		4.1 m 13'5"		3.4 m 11'2"		2.9 m 9'6"	
	m	ft	m	ft	m	ft	m	ft	m	ft	m	ft
A	10.31	33'10"	9.55	31'4"	9.27	30'5"	8.76	28'8"	8.43	27'8"	8.26	27'1"
B	15.67	51'5"	14.37	47'1"	13.69	44'11"	13.08	42'11"	12.42	40'8"	12.00	39'5"
C	10.58	34'8"	9.37	30'8"	8.50	27'11"	8.11	26'7"	7.41	24'4"	6.94	22'10"
D	9.55	31'4"	8.39	27'6"	7.55	24'10"	7.13	23'5"	6.46	21'2"	5.52	18'1"
E	10.09	33'1"	8.90	29'2"	7.98	26'2"	7.59	24'11"	6.89	22'7"	6.41	21'0"
F	12.52	41'1"	11.65	38'2"	11.51	37'10"	11.00	36'1"	10.67	35'0"	10.49	34'5"
G	14.52	47'7"	13.48	44'2"	13.48	44'2"	12.95	42'6"	12.61	41'5"	12.34	40'6"

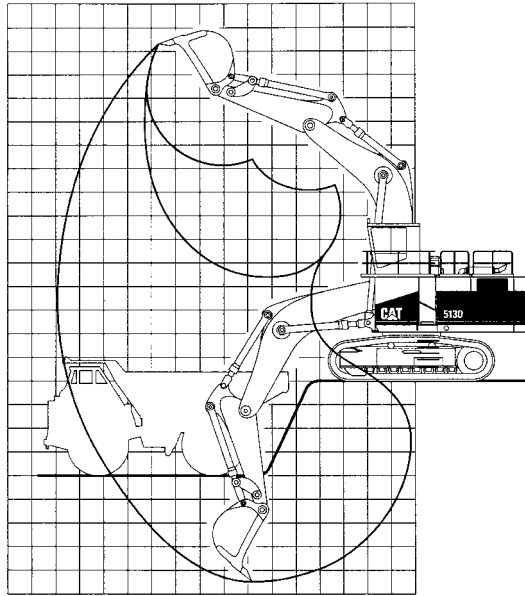

MODEL	5130B ME				5230 ME	
	m	ft	m	ft	m	ft
Boom	8.0	26'3"	8.0	26'3"	—	—
Stick	3.8	12'5"	5.2	17'1"	—	—
Max. Loading Height	9.1	29'8"	9.7	31'8"	9.8	32'2"
Max. Reach	14.9	48'11"	16.1	52'8"	17.7	58'0"
Max. Digging Depth	8.4	27'7"	9.7	31'8"	9.4	30'11"

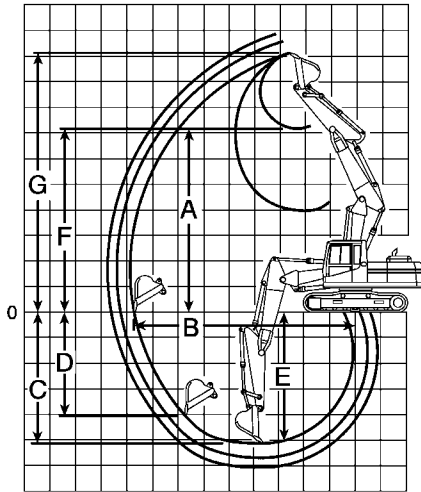

**Variable Adjustable Boom
Digging Envelope**

KEY:

- A** Maximum loading height of bucket with teeth
- B** Maximum reach at ground level
- C** Maximum digging depth
- D** Maximum vertical wall
- E** Maximum depth of cut for 2.44 m (8'0") level bottom (straight clean up)
- F** Maximum bucket hinge pin height
- G** Maximum height, to bucket teeth at highest arc

312B L

Stick	3 m		2.5 m		2.1 m	
	m	ft	m	ft	m	ft
A	7.57	24'10"	7.18	23'7"	6.82	22'5"
B	8.80	28'10"	8.34	27'4"	7.96	26'1"
C	5.73	18'10"	5.24	17'2"	4.84	15'11"
D	3.63	11'11"	3.18	10'5"	2.88	9'5"
E	5.61	18'5"	5.12	16'9"	4.71	15'5"
F	8.81	28'11"	8.41	27'7"	8.05	26'5"
G	10.04	32'11"	9.64	31'7"	9.28	30'5"

315B L

Stick	3.1 m		2.6 m		2.25 m		1.85 m	
	m	ft	m	ft	m	ft	m	ft
A	7.75	25'5"	7.71	25'3"	7.24	23'9"	7.11	23'4"
B	8.92	29'3"	8.61	28'3"	8.20	26'11"	7.90	25'11"
C	3.15	10'4"	2.23	7'4"	2.72	8'11"	2.14	7'0"
D	4.18	13'8"	3.71	12'2"	3.35	11'0"	2.97	9'9"
E	5.68	18'7"	5.26	17'3"	4.87	16'0"	4.51	14'9"
F	8.95	29'4"	8.82	28'11"	8.41	27'7"	8.21	26'11"
G	10.16	33'4"	9.99	32'9"	9.62	31'7"	9.38	30'9"

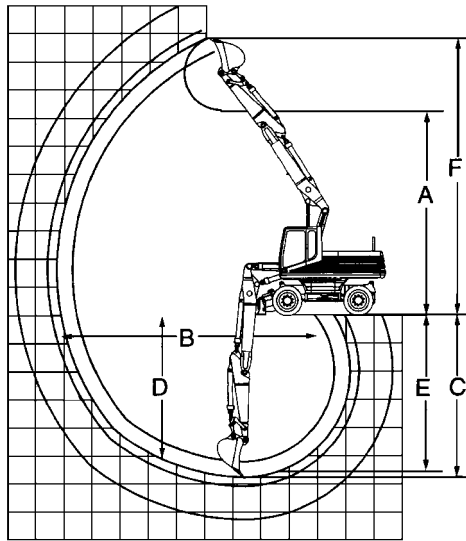

Hydraulic Adjustable Boom Digging Envelope

- Standard 10 × 20 tires and undercarriage
- General purpose bucket

KEY:

- A** Maximum loading height of bucket with teeth
- B** Maximum reach at ground level
- C** Maximum digging depth
- D** Maximum vertical wall
- E** Maximum depth of cut for 2.44 m (8'0") level bottom
- F** Maximum height, to bucket teeth at highest arc

M312

Stick	1.6 m		2 m		2.3 m		2.6 m		3 m	
	m	ft	m	ft	m	ft	m	ft	m	ft
A	6.76	22'2"	7.05	23'1"	7.29	23'9"	7.54	24'7"	7.70	25'3"
B	7.90	25'9"	8.30	27'2"	8.59	28'2"	8.89	29'2"	9.22	30'3"
C	4.62	15'2"	5.02	16'5"	5.32	17'5"	5.62	18'4"	6.00	19'7"
D	2.85	9'3"	3.84	12'6"	4.11	13'5"	4.39	14'4"	4.62	15'2"
E	4.49	14'7"	4.90	16'1"	5.21	17'1"	5.51	18'1"	5.90	19'4"
F	9.13	29'10"	9.49	31'3"	9.73	31'9"	9.97	32'7"	10.13	33'2"

M315

Stick	1.7 m		2.1 m		2.4 m		2.6 m		3.1 m	
	m	ft	m	ft	m	ft	m	ft	m	ft
A	7.03	23'1"	7.32	24'0"	7.56	24'10"	7.72	25'4"	8.04	26'5"
B	8.19	26'10"	8.59	28'2"	8.80	28'10"	9.08	29'9"	9.53	31'3"
C	4.80	13'5"	5.28	17'4"	5.58	18'4"	5.78	19'0"	6.27	20'7"
D	2.96	9'9"	4.05	13'3"	4.34	14'3"	4.53	14'10"	4.91	16'1"
E	4.77	15'8"	5.17	17'0"	5.48	18'0"	5.68	18'8"	6.17	20'3"
F	9.40	30'10"	9.76	32'0"	10.00	32'10"	10.16	33.4"	10.47	34'4"

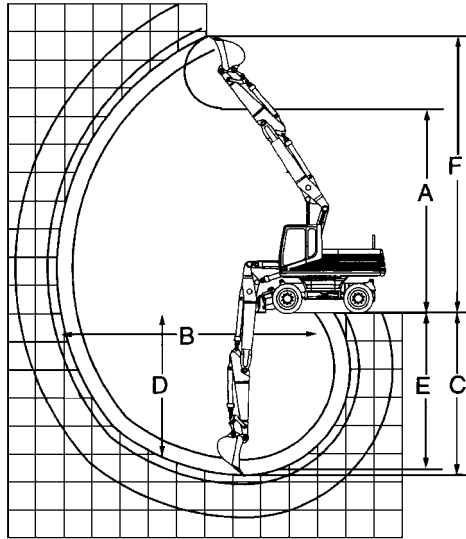

Hydraulic Adjustable Boom Digging Envelope

- Standard 10 × 20 tires and undercarriage
- General purpose bucket

KEY:

- A** Maximum loading height of bucket with teeth
- B** Maximum reach at ground level
- C** Maximum digging depth
- D** Maximum vertical wall
- E** Maximum depth of cut for 2.44 m (8'0") level bottom
- F** Maximum height, to bucket teeth at highest arc

M318

Stick	1.8 m		2.4 m		2.8 m		4 m	
	m	ft	m	ft	m	ft	m	ft
A	6.78	22'3"	7.18	23'7"	7.38	24'3"	7.99	26'3"
B	8.43	27'8"	9.00	29'6"	9.35	30'8"	10.55	34'7"
C	5.20	17'1"	5.79	19'0"	6.18	20'3"	7.44	24'5"
D	3.17	10'5"	4.43	14'6"	4.73	15'6"	5.72	18'9"
E	5.08	16'8"	5.69	18'8"	6.15	20'2"	7.14	23'5"
F	9.38	30'9"	9.84	32'3"	10.02	32'10"	10.79	35'5"

M320

Stick	1.9 m		2.5 m		2.9 m		4.2 m	
	m	ft	m	ft	m	ft	m	ft
A	6.66	21'10"	7.04	23'1"	7.10	23'4"	7.90	25'11"
B	8.82	28'11"	9.38	30'9"	9.67	31'9"	10.96	35'11"
C	5.42	17'9"	6.01	19'9"	6.38	20'11"	7.68	25'2"
D	2.46	8'1"	3.85	12'8"	3.64	11'11"	5.28	17'4"
E	5.00	16'5"	5.62	18'5"	6.00	19'8"	7.36	24'2"
F	9.37	30'9"	9.79	32'1"	9.74	31'11"	10.63	34'11"

Excavators

Range Dimensions

- 320B ● 320B L ● 320B N ● 320B LN
- Belgium Sourced

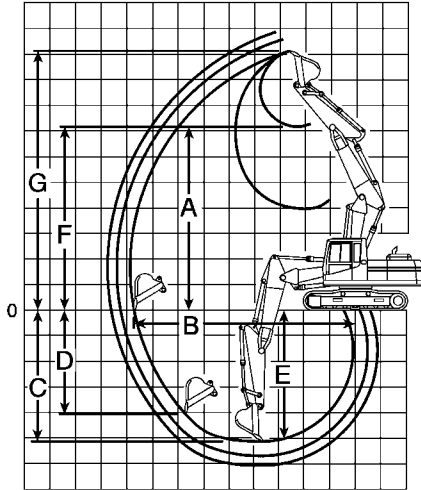

Variable Adjustable Boom Digging Envelope

KEY:

- A** Maximum loading height of bucket with teeth
- B** Maximum reach at ground level
- C** Maximum digging depth
- D** Maximum vertical wall
- E** Maximum depth of cut for 2.44 m (8'0") level bottom (straight clean up)
- F** Maximum bucket hinge pin height
- G** Maximum height, to bucket teeth at highest arc

320B, 320B L, 320B N, 320B LN

Stick	2.92 m		2.4 m		1.9 m	
	m	ft	m	ft	m	ft
A	8.07	26'6"	7.50	24'7"	7.16	23'6"
B	9.55	31'4"	9.19	30'2"	8.65	28'5"
C	6.06	19'11"	5.69	18'8"	5.14	16'11"
D	5.03	16'6"	4.58	15'0"	4.07	13'5"
E	5.95	19'6"	5.58	18'4"	5.01	16'5"
F	9.48	31'1"	9.05	29'8"	8.65	28'5"
G	10.88	35'8"	10.59	34'8"	10.13	33'2"

- 322B L
- 322B N
- 322B LN
- 325B L
- 325B LN
- Belgium Sourced

Range Dimensions

Variable Adjustable Boom Digging Envelope

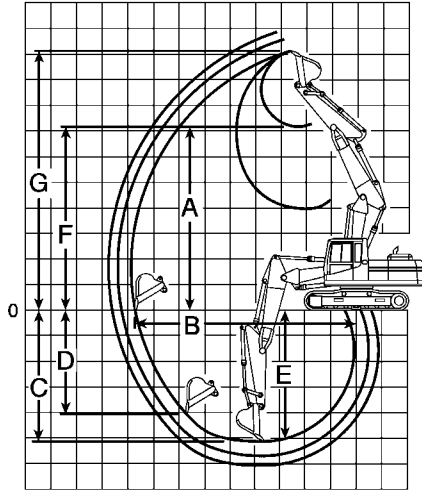

KEY:

- A** Maximum loading height of bucket with teeth
- B** Maximum reach at ground level
- C** Maximum digging depth
- D** Maximum vertical wall
- E** Maximum depth of cut for 2.44 m (8'0\") level bottom (straight clean up)
- F** Maximum bucket hinge pin height
- G** Maximum height, to bucket teeth at highest arc

322B L, 322B N, 322B LN with VA Boom

Stick	2.5 m		8'2"		2 m		6'7"	
	m	ft	m	ft	m	ft	m	ft
A	6.99	22'11"	7.40	24'4"				
B	9.60	31'6"	9.13	30'0"				
C	5.89	19'4"	5.40	17'8"				
D	3.18	10'5"	2.80	9'2"				
E	5.78	19'0"	5.28	17'4"				
F	9.46	31'0"	9.05	29'8"				
G	11.10	36'5"	10.69	35'1"				

325B L, 325B LN with VA Boom

Stick	3.2 m		10'6"		2.5 m		8'2"		2 m		6'7"	
	m	ft	m	ft	m	ft	m	ft	m	ft	m	ft
A	8.59	28'2"	7.89	25'11"	7.51	24'7"						
B	10.24	33'7"	9.75	32'0"	9.28	30'5"						
C	6.40	21'0"	5.89	19'4"	5.40	17'8"						
D	5.28	17'4"	4.71	15'6"	3.94	12'11"						
E	6.30	20'8"	5.78	19'0"	5.28	17'4"						
F	10.08	33'1"	9.55	31'4"	9.17	30'1"						
G	11.57	38'0"	11.21	36'10"	10.83	35'6"						

EXCAVATOR LIFTING CAPACITY

On many sewer jobs an excavator must lift and swing heavy pipe and manboxes in and out of the trench, place manholes and unload material from trucks. In some situations the excavator's lift requirements may be so critical that they determine the size excavator selected.

An excavator's lift capacity depends on its weight, center of gravity, the lift point position (see sketches) and its hydraulic capability. An excavator's lifting capability for any given lift position is limited by its tipping stability or hydraulic capacity.

Changes in boom, stick and bucket position affect attachment geometry and can drastically change a machine's hydraulic lifting capacity. Caterpillar defines excavator lifting capabilities using the following SAE guidelines.

Tipping Conditions — An excavator is considered to be at the tipping point when the weight in the bucket acting at the center of gravity causes the rear rollers to lift clear of the track rails. Suspended loads are considered to be hung from the back of the excavator's bucket or bucket linkage by a sling or chain. Weights of attachments, slings or auxiliary lifting devices are considered part of the suspended load.

Thus, the tipping load is defined as the load producing a tipping condition at a specified radius. The load radius shall be measured as the horizontal distance from the axis of upper structure rotation (before loading) to the center of vertical load line with load applied (dimension A, below). The rating height is based on the vertical distance of the bucket lift point to the ground (dimension B).

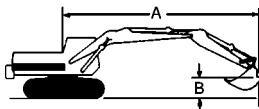

- A. Radius from swing centerline
- B. Bucket lift point height

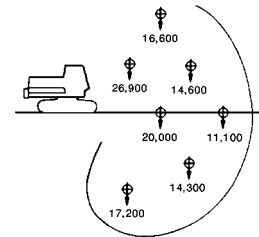

HYPOTHETICAL MACHINE

Rated Hoist Load — The rated load is established using the vertical distance of the lifting point to the ground and the radius of load. Ratings for the ability of a specific machine attachment to lift a load slung from the designated bucket are defined as follows:

- a. The rated load will not exceed 75% of the tipping load.
- b. The rated load will not exceed 87% of the excavator's hydraulic capacity. This means the machine should be able to lift 115% of the rated load.
- c. The rated load will not exceed the machine's structural capability.

This drawing shows how an excavator's lifting capacity can vary with load position:

HYPOTHETICAL MACHINE

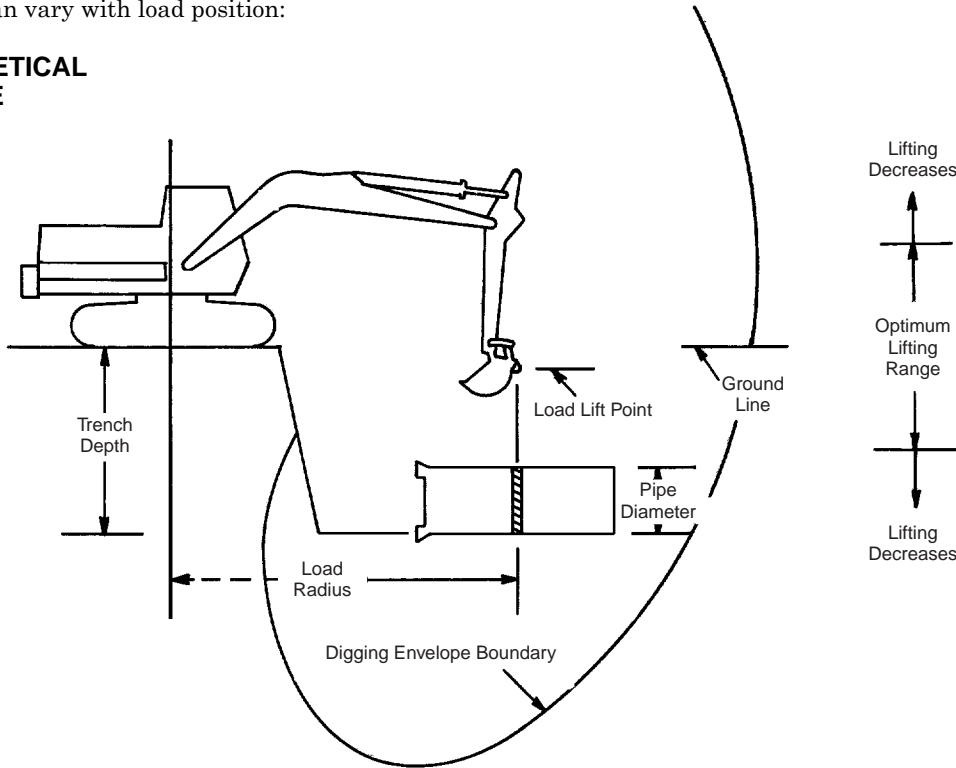

Tips for Lifting Above Ground:

Get the load as close to the excavator as possible.
Use a cable short enough and position the excavator so as to put the load lift point in the “optimum lifting range” (see sketch).

Problem: Long reach cable — Can't lift.

Solution: Shorten reach and cable — Can lift.

Tips for Lifting Below Grade:

Use a cable for sufficient length to position the load lift point in the “optimum lifting range”.

Problem: Short cable, deep trench — Can't lift.

Solution: Lengthen cable to locate bucket hinge pin in optimum lifting area — Can lift.

GROUND LEVEL LIFTING CAPACITIES

The lifting capacities that are shown on the following pages are with the lifting point at ground level. These capacities are rated according to SAE Std. No. J1097.

(For lifting capacities at other heights or with other tools, refer to current Specification Sheets.)

Excavators

Lifting Capacity At Ground Level

● 301.5 ● 307B ● 307B SB ● 307 ● 311B

301.5 ● Bucket Teeth ● Rubber Track ● Canopy ● Blade Raised

Stick	Bucket	kg lb	1.5 m 5'0"		2 m 6'6"		2.5 m 8'0"		3 m 10'0"		3.5 m 11'6"		At Max. Reach	
			Front	Side	Front	Side	Front	Side	Front	Side	Front	Side	Front	Side
890 mm 2'11"	400 mm 16"		620 1360	420 920	410 900	280 610	300 660	210 460	230 500	160 350	—	—	190 410	140 300

301.5 ● Bucket Teeth ● Rubber Track ● Canopy ● Blade Lowered

Stick	Bucket	kg lb	1.5 m 5'0"		2 m 6'6"		2.5 m 8'0"		3 m 10'0"		3.5 m 11'6"		At Max. Reach	
			Front	Side	Front	Side	Front	Side	Front	Side	Front	Side	Front	Side
890 mm 2'11"	400 mm 16"		680* 1490*	490 1080	690* 1520*	330 720	490* 1080*	240 520	390* 850*	190 410	—	—	310* 680*	150 330

307B ● 450 mm (18") Track Shoes

Stick	Bucket	kg lb	3 m 10'0"		4.5 m 15'0"		6 m 20'0"		At Max. Reach	
			Front	Side	Front	Side	Front	Side	Front	Side
1665 mm 5'6"	800 mm 2'7"		2550 5450	2050 4350	1350 2900	1100 2350	—	—	700* 1500*	700* 1500*
2210 mm 7'3"	600 mm 2'0"		2550 5450	2050 4350	1350 2900	1100 2350	—	—	750* 1650*	650 1350

307B SB ● 450 mm (18") Track Shoes ● Swing Boom

Stick	Bucket	kg lb	3 m 10'0"		4.5 m 15'0"		6 m 20'0"		At Max. Reach	
			Front	Side	Front	Side	Front	Side	Front	Side
1665 mm 5'6"	800 mm 2'7"		2700 5800	2150 4600	1500 3150	1200 1550	—	—	850 1900	700 1500
2210 mm 7'3"	600 mm 2'0"		2700 5800	2100 4450	1450 3100	1150 2500	950 2000	750 1600	750 1600	600 1250

307 ● 450 mm (18") Track Shoes

Stick	Bucket	kg lb	3 m 10'0"		4.5 m 15'0"		6 m 20'0"		At Max. Reach	
			Front	Side	Front	Side	Front	Side	Front	Side
1665 mm 5'6"	800 mm 2'7"		2550 5400	2150 4600	1350 2850	1150 2450	—	—	700* 1500*	700* 1500*
2210 mm 7'3"	600 mm 2'0"		2550 5400	2150 4550	1350 2900	1150 2450	—	—	750* 1650*	650* 1450*

311B ● 500 mm (1'8") Track Shoes

Stick	Bucket	kg lb	3 m 10'0"		4.5 m 15'0"		6 m 20'0"		7.5 m 25'0"		At Max. Reach	
			Front	Side	Front	Side	Front	Side	Front	Side	Front	Side
1950 mm 6'5"	925 mm 3'0"		6030 12,910	4160 8940	3060 6570	2210 4750	1930 4130	1390 2980	—	—	1180* 2590*	1130 2490
2250 mm 7'5"	775 mm 2'6"		6130 13,120	4250 9130	3110 6670	2260 4850	1960 4200	1420 3050	—	—	1210* 2660*	1080 2380
2800 mm 9'2"	625 mm 2'0"		6200 13,260	4310 9250	3130 6690	2270 4870	1950 4180	1410 3030	—	—	950* 2090*	930 2050

*Load limited by hydraulic capacity rather than tipping.

312B ● 500 mm (1'8") Track Shoes

Stick	Bucket		3 m 10'0"		4.5 m 15'0"		6 m 20'0"		7.5 m 25'0"		At Max. Reach	
			Front	Side	Front	Side	Front	Side	Front	Side	Front	Side
2100 mm 6'11"	1075 mm 3'6"	kg lb	6160* 14,320*	5080 10,290	4070 8740	2730 5870	2580 5550	1750 3760	—	—	1770* 3910*	1270 2790
2500 mm 8'2"	925 mm 3'0"	kg lb	6730* 15,630*	5220 11,220	4150 8910	2810 6040	2630 5660	1800 3870	—	—	1500* 3300*	1190 2630
3000 mm 9'10"	775 mm 2'6"	kg lb	7810* 17,900*	5280 11,350	4170 8960	2830 6080	2640 5670	1810 3880	1830 4040	1230 2710	1400* 3080*	1080 2370

312B L ● 600 mm (2'0") Track Shoes

Stick	Bucket		3 m 10'0"		4.5 m 15'0"		6 m 20'0"		7.5 m 25'0"		At Max. Reach	
			Front	Side	Front	Side	Front	Side	Front	Side	Front	Side
2100 mm 6'11"	1075 mm 3'6"	kg lb	6160* 14,320*	5290 11,360	4850 10,400	2850 6130	3060 6570	1830 3930	—	—	1770* 3910*	1330 2930
2500 mm 8'2"	925 mm 3'0"	kg lb	6730* 15,630*	5430 11,670	4930 10,580	2920 6290	3110 6680	1880 4040	—	—	1500* 3300*	1250 2760
3000 mm 9'10"	925 mm 3'0"	kg lb	7760* 18,060*	5460 11,740	4930 10,590	2920 6280	3090 6640	1860 3990	2090 4600	1270 2790	1360* 3000*	1100 2420

**312B L France Sourced ● 500 mm (1'8") Track Shoes — 2100/2500 (6'11"/8'2") Stick
 ● 920 mm (3'0") Bucket ● 600 mm (2'0") Track Shoes — 3000 mm (9'10") Stick**

Stick			3 m 10'0"		4.5 m 15'0"		6 m 20'0"		7.5 m 25'0"		At Max. Reach	
			Front	Side	Front	Side	Front	Side	Front	Side	Front	Side
2100 mm 6'11"	kg lb		6250 2840	5080 2310	4660 2120	2760 1250	2970 1350	1800 820	—	—	1770 800	1290 590
2500 mm 8'2"	kg lb		6810 3100	5220 2370	4740 2150	2820 1280	3000 1360	1830 830	—	—	1490 680	1200 540
3000 mm 9'10"	kg lb		7480 3400	5450 2480	4940 2240	2930 1330	3110 1410	1880 850	2160 980	1300 590	1360 620	1110 500

315B ● 500 mm (1'8") Track Shoes

Stick	Bucket		3 m 10'0"		4.5 m 15'0"		6 m 20'0"		7.5 m 25'0"		At Max. Reach	
			Front	Side	Front	Side	Front	Side	Front	Side	Front	Side
1850 mm 6'1"	1220 mm 4'0"	kg lb	—	—	5300 11,350	3400 7350	3400 7250	2200 4750	—	—	2400 5250	1550 3400
2250 mm 7'5"	1070 mm 3'6"	kg lb	5500* 12,700*	5500* 12,700*	5450 11,750	3600 7700	3500 7500	2300 4950	—	—	2250* 5000*	1500 3250
2600 mm 8'6"	1070 mm 3'6"	kg lb	5900* 13,600*	5900* 13,600*	5500 11,750	3600 7700	3500 7450	2300 4950	2400 5300	1600 3500	1950* 4250*	1350 3000
3100 mm 10'2"	770 mm 2'6"	kg lb	7000* 16,100*	6700 14,400	5500 11,850	3600 7750	3500 7500	2350 5000	2450 5250	1600 3450	1800* 3950*	1300 2800

*Load limited by hydraulic capacity rather than tipping.

Excavators

Lifting Capacity At Ground Level

- 315B L ● 318B L

315B L ● 1070 mm (3'6") Bucket ● 600 mm (2'0") Track Shoes

Stick	Bucket		3 m 10'0"		4.5 m 15'0"		6 m 20'0"		7.5 m 25'0"		At Max. Reach	
			Front	Side	Front	Side	Front	Side	Front	Side	Front	Side
1850 mm 6'1"	1220 mm 4'0"	kg lb	—	—	6250 13,450	3500 7500	3950 8500	2300 4850	—	—	2700* 5950*	1600 3500
2250 mm 7'5"	1070 mm 3'6"	kg lb	5500* 12,700*	5500* 12,700*	6550 14,050	3700 8000	4150 8850	2400 5200	—	—	2250* 5000*	1550 3450
2600 mm 8'6"	1070 mm 3'6"	kg lb	5900* 13,600*	5900* 13,600*	6550 14,050	3750 8000	4150 8850	2400 5150	2900 6350	1650 3650	1950* 4250*	1450 3150
3100 mm 10'2"	770 mm 2'6"	kg lb	7000* 16,100*	6950 14,950	6600 14,150	3750 8100	4150 8900	2450 5200	2900 6250	1700 3600	1800* 3950*	1350 2950

France Sourced

315B L ● 0.93 m³ (1.22 yd³) Bucket ● 600 mm (2'0") Track Shoes

Stick			3 m 10'0"		4.5 m 15'0"		6 m 20'0"		7.5 m 25'0"		At Max. Reach	
			Front	Side	Front	Side	Front	Side	Front	Side	Front	Side
1850 mm 6'1"	kg lb		—	—	6570 14,480	4080 8990	4150 9150	2640 5820	—	—	2550* 5620*	1840 4050
2250 mm 7'5"	kg lb		—	—	6760 14,900	4260 9390	4250 9370	2740 6040	—	—	2760 6080	1770 3900
2600 mm 8'6"	kg lb		5290* 11,660	5290* 11,660	6780 14,950	4270 9410	4240 9340	2730 6020	2940 6480	1880 4140	1830* 4030*	1600 3520
3100 mm 10'2"	kg lb		6340* 13,980*	6340* 13,980*	6800 14,990	4280 9430	4230 9320	2720 5990	2920 6430	1860 4100	1620* 3570*	1430 3150

Japan Sourced

318B L ● 600 mm (2'0") Track Shoes

Stick	Bucket		3 m 10'0"		4.5 m 15'0"		6 m 20'0"		7.5 m 25'0"		At Max. Reach	
			Front	Side	Front	Side	Front	Side	Front	Side	Front	Side
3200 mm 10'6"	625 mm 2'0"	kg lb	5600* 19,900*	5600* 12,900*	7700 16,450	4600 9800	4800 10,250	2900 6250	3300 7050	2000 4250	2200* 4800*	1400 3050
2700 mm 8'10"	775 mm 2'6"	kg lb	6550* 14,350*	6550* 14,350*	7500 16,100	4450 9500	4700 10,050	2850 6050	3250 6950	1950 4150	2550* 5600*	1500 3300
2250 mm 7'5"	775 mm 2'6"	kg lb	—	—	7450 15,950	4350 9350	4650 9950	2800 5950	—	—	2850 6200	1650 3650
1800 mm 5'11"	932 mm 3'0"	kg lb	—	—	7400 15,850	4300 9250	4650 9900	2750 5950	—	—	3100 6800	1850 4000

*Load limited by hydraulic capacity rather than tipping.

France Sourced

318B L ● 0.8 m³ (1.05 yd³) Bucket ● 600 mm (2'0") Track Shoes

Stick	Bucket	3 m 10'0"		4.5 m 15'0"		6 m 20'0"		7.5 m 25'0"		At Max. Reach	
		Front	Side	Front	Side	Front	Side	Front	Side	Front	Side
1800 mm 5'11"	kg lb	—	—	8920* 19,660*	5030 11,090	5700 12,560	3260 7180	—	—	3820 8420	2200 4850
2250 mm 7'5"	kg lb	—	—	8830* 19,470*	5070 11,170	5700 12,560	3260 7180	—	—	3190* 7030*	1980 4360
2700 mm 8'10"	kg lb	5380* 11,860*	5380* 11,860*	8630* 19,020*	5100 11,240	5700 12,560	3260 7180	3950 8710	2250 4960	2240* 4930*	1770 3900
3200 mm 10'6"	kg lb	6850* 15,100*	6850* 15,100*	8440* 18,610*	5040 11,110	5570 12,280	3200 7050	3840 8460	2200 4850	2440* 5380	1620 3570

4

Japan Sourced

318B LN ● 500 mm (1'8") Track Shoes

Stick	Bucket	3 m 10'0"		4.5 m 15'0"		6 m 20'0"		7.5 m 25'0"		At Max. Reach	
		Front	Side	Front	Side	Front	Side	Front	Side	Front	Side
3200 mm 10'6"	625 mm 2'0" kg lb	5600* 12,900*	5600* 12,900*	7550 16,200	3950 8500	4700 10,050	2500 5350	3250 6950	1700 3600	2200* 4800*	1150 2550
2700 mm 8'10"	775 mm 2'6" kg lb	5550* 12,850*	5550* 12,850*	7500 16,050	3900 8400	4700 10,050	2500 5350	3250 6950	1700 3650	2600 5700	1350 2900
2250 mm 7'5"	775 mm 2'6" kg lb	—	—	7300 16,300	4000 8550	4550 9750	1400 5100	—	—	2750 6100	1400 3050
1800 mm 5'11"	775 mm 2'6" kg lb	—	—	7150 15,350	3600 7750	4500 9600	2300 4950	—	—	3000 6550	1500 3250

France Sourced

318B LN ● 0.8 m³ (1.05 yd³) Bucket ● 500 mm (1'8") Track Shoes

Stick	Bucket	3 m 10'0"		4.5 m 15'0"		6 m 20'0"		7.5 m 25'0"		At Max. Reach	
		Front	Side	Front	Side	Front	Side	Front	Side	Front	Side
1800 mm 5'11"	kg lb	—	—	7420 16,360	3860 8510	4680 10,310	2510 5530	—	—	3150 6940	1680 3700
2250 mm 7'5"	kg lb	—	—	7490 16,510	3910 8620	4700 10,360	2520 5550	—	—	2870 6320	1510 3320
2700 mm 8'10"	kg lb	5410* 11,920*	5410* 11,920*	7560 16,660	3970 8750	4730 10,420	2550 5620	3290 7250	1740 3830	2610* 5750*	1360 2990
3200 mm 10'6"	kg lb	6850* 15,100*	6850* 15,100*	7590 16,730	3980 8770	4720 10,400	2540 5600	3270 7210	1720 3870	2440* 5380*	1250 2750

*Load limited by hydraulic capacity rather than tipping.

M312 ● 4-Point Outriggers Down ● 1000 mm (3'3") Bucket ● One-Piece Boom

Stick		3 m 10'0"		4.5 m 15'0"		6 m 20'0"		7.5 m 25'0"		At Max. Reach	
		Front	Side	Front	Side	Front	Side	Front	Side	Front	Side
1600 mm 5'3"	kg lb	—	—	5500* 12,120*	5250 11,580	3950* 8710*	3350 7390	—	—	2350* 5180*	2350 5180
2000 mm 6'6"	kg lb	—	—	5500* 12,130*	5300 11,690	3900* 8600*	3300 7280	—	—	1500* 3310*	1500* 3310*
2300 mm 7'5"	kg lb	2700* 5950*	2700* 5950*	5500* 12,120*	5300 11,680	3900* 8590*	3300 7270	—	—	1260* 2780*	1260* 2780*
2600 mm 8'5"	kg lb	2900* 6390*	2900* 6390*	5400* 11,900*	5300 11,680	3900* 8590*	3330 7340	2100* 4630*	2100* 4630*	1100* 2420*	1100* 2420*
3000 mm 9'9"	kg lb	3600* 7930*	3600* 7930*	5360* 11,810*	5300 11,680	3800 8370	3360 7400	2600* 5730*	2300 5070	1000* 2200*	1000 2200

M312 ● Free On Wheels ● 1000 mm (3'3") Bucket ● One-Piece Boom

Stick		3 m 10'0"		4.5 m 15'0"		6 m 20'0"		7.5 m 25'0"		At Max. Reach	
		Front	Side	Front	Side	Front	Side	Front	Side	Front	Side
1600 mm 5'3"	kg lb	—	—	3900 8590	2100 4630	2500 5510	1400 3080	—	—	1800 2860	900 1980
2000 mm 6'6"	kg lb	—	—	4000 8820	2200 4850	2500 5510	1400 3090	—	—	1500* 3310*	900 1980
2300 mm 7'5"	kg lb	2700* 5950*	2700* 5950*	4000 8820	2200 4850	2600 5730	1400 3080	—	—	1300* 2860*	800 1760
2600 mm 8'5"	kg lb	2300* 5070*	2300* 5070*	4000 8820	2100 4630	2500 5510	1960 4320	1800 3960	300 660	1160* 2550*	700 1540
3000 mm 9'9"	kg lb	3600* 7930*	3600* 7930*	4000 8820	2100 4630	2500 5510	1400 3080	1800 3960	360 790	1000* 2200*	740 1630

M312 ● 4-Point Outriggers Down ● 1000 mm (3'3") Bucket ● VA Boom

Stick		3 m 10'0"		4.5 m 15'0"		6 m 20'0"		7.5 m 25'0"		At Max. Reach	
		Front	Side	Front	Side	Front	Side	Front	Side	Front	Side
1600 mm 5'3"	kg lb	7900* 17,410*	7900* 17,410*	5400* 11,900*	5300 11,680	3800* 8370*	3400 7500	—	—	2300* 5070*	2200 4850
2000 mm 6'6"	kg lb	7900* 17,420*	7900* 17,420*	5400* 11,910*	5300* 11,690*	3900* 8600*	3500 7720	—	—	1500* 3310*	1500* 3310*
2300 mm 7'5"	kg lb	7600* 16,750*	7600* 16,750*	5900* 13,000*	5300 11,680	3900* 8590*	3500 3300	2400* 5290*	2400* 5290*	1300* 2860*	1300 2860
2600 mm 8'5"	kg lb	7100* 15,650*	7100* 15,650*	5300* 11,680	5300 11,680	3860* 8510*	3560 7840	2300* 5070*	2400 5290	1100* 2420*	1100* 2420*
3000 mm 9'9"	kg lb	7100* 15,650*	7100* 15,650*	5200* 11,460*	5200 11,460	3740* 8240*	3440* 7580*	2900* 6390*	2400 5290	1040* 2290*	1040* 2290*

M312 ● Free On Wheels ● 1000 mm (3'3") Bucket ● VA Boom

Stick		3 m 10'0"		4.5 m 15'0"		6 m 20'0"		7.5 m 25'0"		At Max. Reach	
		Front	Side	Front	Side	Front	Side	Front	Side	Front	Side
1600 mm 5'3"	kg lb	7900* 17,410*	4700 10,360	4400 9700	2500 5510	2600 5730	1400 3080	—	—	1600 3520	800 1760
2000 mm 6'6"	kg lb	7900* 17,420*	4800 10,580	4400 9700	2600 5730	2700 5950	1500 3310	—	—	1500* 3310*	800 1760
2300 mm 7'5"	kg lb	7600* 16,750*	4900 10,800	4300 9480	2600 5730	2800 6170	1600 3520	1800 3960	900 1980	1300* 2860*	800 1760
2600 mm 8'5"	kg lb	7100* 15,650*	4800 10,580	4300 9480	2700 5950	2800 6170	1600 3520	1800 3960	900 1980	1100* 2420*	700 1100
3000 mm 9'9"	kg lb	7100* 15,650*	4900* 10,800*	4300 9480	2600 5730	2800 6170	1700 3740	1800 3960	1000 2200	1060* 2330*	700 1100

*Load limited by hydraulic capacity rather than tipping.

M315 ● 4-Point Outriggers Down ● 1100 mm (3'7") Bucket ● One-Piece Boom

Stick		3 m 10'0"		4.5 m 15'0"		6 m 20'0"		7.5 m 25'0"		At Max. Reach	
		Front	Side	Front	Side	Front	Side	Front	Side	Front	Side
1700 mm 5'10"	kg lb	—	—	6700* 14,770*	6400 14,110	4800* 10,580*	4100 9040	—	—	2600* 5730*	2600* 5730*
2100 mm 6'11"	kg lb	—	—	6700* 14,770*	6500 14,330	4800* 10,580*	4100 9040	—	—	1700* 3740*	1700* 3740*
2400 mm 7'10"	kg lb	2500* 5510*	2500* 5510*	6700* 14,770*	6500 14,330	4800* 10,580*	4100 9040	2900* 6390*	2900* 6390*	1500* 3300*	1500* 3300*
2600 mm 8'6"	kg lb	2700* 5950*	2700* 5950*	6700* 14,770*	6500 14,330	4800* 10,580*	4100 9040	3300* 7270*	2900* 6390*	1300* 2860*	1300* 2860*

4

M315 ● Free On Wheels ● 1100 mm (3'7") Bucket ● One-Piece Boom

Stick		3 m 10'0"		4.5 m 15'0"		6 m 20'0"		7.5 m 25'0"		At Max. Reach	
		Front	Side	Front	Side	Front	Side	Front	Side	Front	Side
1700 mm 5'10"	kg lb	—	—	4700 10,360	2600 5730	3100 6830	1700 3740	—	—	2000 4410	1100 2420
2100 mm 6'11"	kg lb	—	—	4800 10,580	2700 5950	3100 6830	1700 3740	—	—	1700* 3740*	1000 2200
2400 mm 7'10"	kg lb	2500* 5510*	2500* 5510*	4800 10,580	2700 5950	3100 6830	1700 3740	2200 4850	1200 2640	1500* 3300*	1000 2200
2600 mm 8'6"	kg lb	2700* 5950*	2700* 5950*	4800 10,580	2700 5950	3100 6830	1700 3740	2200 4850	1200 2640	1300* 2860*	900 1980

M315 ● 4-Point Outriggers Down ● 1100 mm (3'7") Bucket ● VA Boom

Stick		3 m 10'0"		4.5 m 15'0"		6 m 20'0"		7.5 m 25'0"		At Max. Reach	
		Front	Side	Front	Side	Front	Side	Front	Side	Front	Side
1700 mm 5'10"	kg lb	9500* 20,940*	9500* 20,940*	6600* 14,550*	6600* 14,550*	4700* 10,360*	4300 9430	—	—	2400* 5290*	2400* 5290*
2100 mm 6'11"	kg lb	8900* 19,620*	8900* 19,620*	6600* 14,550*	6500 14,330	4700* 10,360*	4300 9480	3000* 6610*	2900 6390	1600* 3520*	1600* 3520*
2400 mm 7'10"	kg lb	8300* 18,300*	8300* 18,300*	6500* 14,330*	6500* 14,330	4700* 10,360*	4300 9480	3000* 6610*	2900 6390	1400* 3080*	1400* 3080*
2600 mm 8'6"	kg lb	8500* 18,740*	8500* 18,740*	6500* 14,330*	6500* 14,330*	4600* 10,140*	4200 9260	3000* 6610*	2900 6390	1300* 2860*	1300* 2860*

M315 ● Free On Wheel ● 1100 mm (3'7") Bucket ● VA Boom

Stick		3 m 10'0"		4.5 m 15'0"		6 m 20'0"		7.5 m 25'0"		At Max. Reach	
		Front	Side	Front	Side	Front	Side	Front	Side	Front	Side
1700 mm 5'10"	kg lb	9500* 20,940*	5800 12,780	5200 11,460	3200 7050	3200 7050	1800 3960	—	—	1900 4180	1000 2200
2100 mm 6'11"	kg lb	8900* 19,620*	5900 13,000	5200 11,460	3200 7050	3300 7270	2000 4410	2200 4850	1200 2640	1600* 3520*	1000 2200
2400 mm 7'10"	kg lb	8300* 18,300*	6000 13,230	5200 11,460	3200 7050	3400 7490	2000 4410	2200 4850	1200 2640	1400* 3080*	900 1980
2600 mm 8'6"	kg lb	8500* 18,740*	5800 12,780	5200 11,460	3300 7270	3400 7490	2000 4410	2200 4850	1200 2640	1300* 2860*	900 1980

*Load limited by hydraulic capacity rather than tipping.

Excavators

Lifting Capacity At Ground Level

● M318

M318 ● 4-Point Outriggers Down ● 1200 mm (3'11") Bucket ● One-Piece Boom

Stick		3 m 10'0"		4.5 m 15'0"		6 m 20'0"		7.5 m 25'0"		At Max. Reach	
		Front	Side	Front	Side	Front	Side	Front	Side	Front	Side
1800 mm 5'11"	kg lb	—	—	7700* 16,970*	7200 15,870	5500* 12,120*	4600 10,140	—	—	3100* 6830*	2700 5950
2400 mm 7'10"	kg lb	—	—	7700* 16,970*	7300 16,090	5500* 12,120*	4600 10,140	4200* 9260*	3200 7050	1800* 3960*	1800* 3960*
2800 mm 9'2"	kg lb	3800* 8370*	3800* 8370*	7600* 16,750*	7400 16,310	5400* 11,900*	4600 10,140	4200* 9260*	3200 7050	1600* 3520*	1600* 3520*
4000 mm 13'2"	kg lb	5100* 11,240*	5100* 11,240*	6900* 15,210*	6900* 15,210*	4900 10,800	4600 10,140	3800* 8370*	3200 7050	900* 1980*	900* 1980*

M318 ● Free On Wheels ● 1200 mm (3'11") Bucket ● One-Piece Boom

Stick		3 m 10'0"		4.5 m 15'0"		6 m 20'0"		7.5 m 25'0"		At Max. Reach	
		Front	Side	Front	Side	Front	Side	Front	Side	Front	Side
1800 mm 5'11"	kg lb	—	—	5900 13,000	2900 6390	3700 8150	1900 4180	—	—	2200 4850	1100 2420
2400 mm 7'10"	kg lb	—	—	5900 13,000	3000 6610	3800 8370	1900 4180	2600 5730	1300 2860	1800* 3960*	1000 2200
2800 mm 9'2"	kg lb	3800* 8370*	3800* 8370*	5900 13,000	3000 6610	3800 8370	1900 4180	2600 5730	1300 2860	1600* 3520*	900 1980
4000 mm 13'2"	kg lb	5100* 11,240*	5100* 11,240*	6000 13,230	3100 6830	3800 8370	1900 4180	2600 5730	1300 2860	900 1980	600 1320

M318 ● 4-Point Outriggers Down ● 1200 mm (3'11") Bucket ● VA Boom

Stick		3 m 10'0"		4.5 m 15'0"		6 m 20'0"		7.5 m 25'0"		At Max. Reach	
		Front	Side	Front	Side	Front	Side	Front	Side	Front	Side
1800 mm 5'11"	kg lb	10 800* 23,810*	10 800* 23,810*	7600* 16,750*	7400* 16,310*	5400* 11,900*	4900 10,800	—	—	2900* 6390*	2800 6170
2400 mm 7'10"	kg lb	10 200* 22,490*	10 200* 22,490*	7500* 16,530*	7400* 16,310*	5300* 11,680*	4800 10,580	4100* 9040*	3300 7270	1600* 3520*	1600* 3520*
2800 mm 9'2"	kg lb	10 200* 22,490*	10 200* 22,490*	7400* 16,310*	7400* 16,310*	5200* 11,460*	4800 10,580	4100* 9040*	3300 7270	1400* 3080*	1400* 3080*
4000 mm 13'2"	kg lb	6500* 14,330*	6500* 14,330*	4600* 10,140*	4600* 10,140*	3600* 7930*	3300 7270	2300* 5070*	2300* 5070*	800 1760	800 1760

M318 ● Free On Wheels ● 1200 mm (3'11") Bucket ● VA Boom

Stick		3 m 10'0"		4.5 m 15'0"		6 m 20'0"		7.5 m 25'0"		At Max. Reach	
		Front	Side	Front	Side	Front	Side	Front	Side	Front	Side
1800 mm 5'11"	kg lb	10 800* 23,810*	6800 14,990	6400 14,110	3700 8150	4100 9040	2200 4850	—	—	2200 4850	1100 2420
2400 mm 7'10"	kg lb	10 200* 22,490*	6900 15,210	6400 14,110	3800 8370	4200 9260	2300 5070	2700 5950	1400 3080	1600 3520	1000 2200
2800 mm 9'2"	kg lb	10 200* 22,490*	6900 15,210	6300 13,890	3800 8370	4100 9040	2400 5290	2800 6170	1400 3080	1400* 2200*	900 1980
4000 mm 13'2"	kg lb	—	—	6100 13,450	3600 7930	4000 8820	2400 5290	2800 6170	1600 3520	800* 1760*	600 1320

*Load limited by hydraulic capacity rather than tipping.

M320 ● Rear Dozer Up ● One-Piece 5.65 m (18'6") Boom

Stick	Bucket	3 m 10'0"		4.5 m 15'0"		6 m 20'0"		7.5 m 25'0"		9 m 30'0"		At Max. Reach		
		Front	Side	Front	Side	Front	Side	Front	Side	Front	Side	Front	Side	
1900 mm 6'3"	1.05 m ³ 1.37 yd ³	kg lb	—	—	6600 14,550	3500 7700	4800 10,580	2300 5070	2900 6350	1500 3300	—	—	2200 4850	1100 2400
2500 mm 8'2"	0.9 m ³ 1.17 yd ³	kg lb	—	—	6700 14,750	3600 7930	4200 9250	2300 5050	3000 6600	1600 3500	—	—	1300* 2850	1000 2200
2900 mm 9'6"	0.81 m ³ 1.06 yd ³	kg lb	—	—	6700 14,750	3600 7900	4200 9250	2300 5050	3000 6600	1600 3500	—	—	1100* 2400	900 1950
4200 mm 13'9"	0.55 m ³ 0.72 yd ³	kg lb	—	—	6900 15,200	3700 8150	4300 9450	2400 5250	3000 6600	1600 3500	2200 4850	1100 2400	600* 1300	600* 1300

4

M320 ● Rear Dozer Down ● One-Piece 5.65 m (18'6") Boom

Stick	Bucket	3 m 10'0"		4.5 m 15'0"		6 m 20'0"		7.5 m 25'0"		9 m 30'0"		At Max. Reach		
		Front	Side	Front	Side	Front	Side	Front	Side	Front	Side	Front	Side	
1900 mm 6'3"	1.05 m ³ 1.37 yd ³	kg lb	—	—	9000* 19,800*	4200 9250	6400* 14,100*	2700 5950	4800* 10,550*	1900 4150	—	—	3000* 6600*	1400 3050
2500 mm 8'2"	0.9 m ³ 1.17 yd ³	kg lb	—	—	9000* 19,800*	4300 9450	6300* 13,850*	2800 6150	4900* 10,800*	1900 4150	—	—	1300* 2850*	1300 2850
2900 mm 9'6"	0.81 m ³ 1.06 yd ³	kg lb	—	—	8900* 19,600*	4300 9450	6200* 13,650*	2800 6150	4800* 10,550*	1900 4150	—	—	1100* 2400*	1100* 2400*
4200 mm 13'9"	0.55 m ³ 0.72 yd ³	kg lb	—	—	8100* 17,850*	4500 9900	5600* 12,300*	2900 6350	4400* 9700*	1900 4150	3600* 7900*	1400 3050	600* 1300*	600 1300*

M320 ● Rear Stabilizer Down ● One-Piece 5.65 m (18'6") Boom

Stick	Bucket	3 m 10'0"		4.5 m 15'0"		6 m 20'0"		7.5 m 25'0"		9 m 30'0"		At Max. Reach		
		Front	Rear	Front	Rear	Front	Rear	Front	Rear	Front	Rear	Front	Rear	
1900 mm 6'3"	1.05 m ³ 1.37 yd ³	kg lb	—	—	9000* 19,800*	5400 11,900	6200 13,650	3500 7700	4300 9450	2400 5250	—	—	3000* 6600*	1800 3960
2500 mm 8'2"	0.9 m ³ 1.17 yd ³	kg lb	—	—	9000* 19,800*	5500 12,100	6300 13,850	3500 7700	4300 9450	2400 5250	—	—	1300* 2850*	1300* 2850*
2900 mm 9'6"	0.81 m ³ 1.06 yd ³	kg lb	—	—	8900* 19,600*	5500 12,100	6200* 13,650*	3500 7700	4300 9450	2500 5500	—	—	1100* 2400*	1100* 2400*
4200 mm 13'9"	0.55 m ³ 0.72 yd ³	kg lb	—	—	8100* 17,850*	5700 12,550	5600* 12,300*	3600 7900	4400 9700	2500 5500	3200 7050	1800 3950	600* 1300*	600* 1300*

M320 ● 4-Point Stabilizers Down ● One-Piece 5.65 m (18'6") Boom

Stick	Bucket	3 m 10'0"		4.5 m 15'0"		6 m 20'0"		7.5 m 25'0"		9 m 30'0"		At Max. Reach		
		Front	Side	Front	Side	Front	Side	Front	Side	Front	Side	Front	Side	
1900 mm 6'3"	1.05 m ³ 1.37 yd ³	kg lb	—	—	9000* 19,800*	9000* 19,800*	6400* 14,100*	5600 12,300	4800* 10,550*	3900 8550	—	—	3000* 6600*	3000 6600
2500 mm 8'2"	0.9 m ³ 1.17 yd ³	kg lb	—	—	9000* 19,800*	9000* 19,800*	6300* 13,850	5700 12,550	4900* 10,800*	4000 8800	—	—	1300* 2850*	1300* 2850*
2900 mm 9'6"	0.81 m ³ 1.06 yd ³	kg lb	—	—	8900* 19,600*	8900* 19,600*	6200* 13,650*	5700 12,550	4800* 10,550*	4000 8800	—	—	1100* 2400*	1100* 2400*
4200 mm 13'9"	0.55 m ³ 0.72 yd ³	kg lb	—	—	8100* 17,850*	8100* 17,850*	5600* 12,300*	5600* 12,300*	4400* 9700*	4000 8800	3600* 7900*	3000 6600	600* 1300*	600* 1300*

M320 ● Dozer and Stabilizer Down ● One-Piece 5.65 m (18'6") Boom

Stick	Bucket	3 m 10'0"		4.5 m 15'0"		6 m 20'0"		7.5 m 25'0"		9 m 30'0"		At Max. Reach		
		Front	Side	Front	Side	Front	Side	Front	Side	Front	Side	Front	Side	
1900 mm 6'3"	1.05 m ³ 1.37 yd ³	kg lb	—	—	9000* 19,800*	7200 15,850	6400* 14,100*	4600 10,100	4800* 10,550*	3200 7050	—	—	3000* 6600*	2400 5250
2500 mm 8'2"	0.9 m ³ 1.17 yd ³	kg lb	—	—	9000* 19,800*	7300 16,050	6300* 13,850*	4600 10,100	4900* 10,800*	3300 7250	—	—	1300* 2850*	1300* 2850*
2900 mm 9'6"	0.81 m ³ 1.06 yd ³	kg lb	—	—	8900* 19,600*	7300 16,050	6200* 13,650*	4600 10,100	4800* 10,550*	3200 7050	—	—	1100* 2400*	1100* 2400*
4200 mm 13'9"	0.55 m ³ 0.72 yd ³	kg lb	—	—	8100* 19,600*	7500 16,500	5600* 12,300*	4700 10,350	4400* 9700*	3300 7250	3600* 7900*	2400 5250	600* 1300*	600* 1300*

*Load limited by hydraulic capacity rather than tipping.

Excavators

Lifting Capacity At Ground Level

● M320

M320 ● Rear Dozer Up ● VA Boom @ 5.41 m (17'9") Max.

Stick	Bucket	3 m 10'0"		4.5 m 15'0"		6 m 20'0"		7.5 m 25'0"		9 m 30'0"		At Max. Reach		
		Front	Side	Front	Side	Front	Side	Front	Side	Front	Side	Front	Side	
1900 mm 6'3"	1.05 m ³ 1.37 yd ³	kg lb	12 800* 28,200*	8300 18,300	7400 16,300	4500 9900	4800 10,550	2700 5950	3000 6600	1600 3500	—	—	2400 5250	1200 2600
2500 mm 8'2"	0.9 m ³ 1.17 yd ³	kg lb	12 400* 27,300*	8600 18,950	7300 16,050	4600 10,100	4700 10,350	2900 6350	3200 7050	1700 3700	—	—	1400* 3050*	1100 2400
2900 mm 9'6"	0.81 m ³ 1.06 yd ³	kg lb	12 100* 26,650*	8400 18,500	7200* 15,850*	4500 9900	4700 10,350	2900 6350	3200 7050	1800 3950	—	—	1200* 2600*	1000 2200
4200 mm 13'9"	0.55 m ³ 0.72 yd ³	kg lb	10 800* 23,800*	8300 18,300	7100* 15,650*	4400 9700	4600 10,100	2900 6350	3300 7250	2000 4400	2300 5050	1200 2600	600* 1300*	600* 1300*

M320 ● Rear Dozer Down ● VA Boom @ 5.41 m (17'9") Max.

Stick	Bucket	3 m 10'0"		4.5 m 15'0"		6 m 20'0"		7.5 m 25'0"		9 m 30'0"		At Max. Reach		
		Front	Side	Front	Side	Front	Side	Front	Side	Front	Side	Front	Side	
1900 mm 6'3"	1.05 m ³ 1.37 yd ³	kg lb	12 800* 28,200*	10 100 22,250	8900* 19,600*	5300 11,650	6300* 13,850*	3200 7050	4800* 10,550*	1900 4150	—	—	3000* 6600*	1500 3300
2500 mm 8'2"	0.9 m ³ 1.17 yd ³	kg lb	12 400* 27,300*	10 000 22,050	8800* 19,400*	5300 11,650	6200* 13,650*	3400 7450	4800* 10,550*	2100 4600	—	—	1400* 3050*	1400 3050
2900 mm 9'6"	0.81 m ³ 1.06 yd ³	kg lb	12 100* 26,650*	9900 21,800	8600* 18,950*	5200 11,450	6000* 13,200*	3400 7450	4700* 10,350*	2100 4600	—	—	1200* 2600*	1200 2600
4200 mm 13'9"	0.55 m ³ 0.72 yd ³	kg lb	10 800* 23,800*	9700* 21,350*	7600* 16,750*	5100 11,200	5300* 11,650*	3300 7250	4200* 9250*	2400 5250	3400* 7450*	1500 3300	600* 1300*	600* 1300*

M320 ● Rear Stabilizer Down ● VA Boom @ 5.41 m (17'9") Max.

Stick	Bucket	3 m 10'0"		4.5 m 15'0"		6 m 20'0"		7.5 m 25'0"		9 m 30'0"		At Max. Reach		
		Front	Side	Front	Side	Front	Side	Front	Side	Front	Side	Front	Side	
1900 mm 6'3"	1.05 m ³ 1.37 yd ³	kg lb	12 800* 28,200*	12 400 27,300	8900* 19,600*	6400 14,100	6300* 13,850*	4000 8800	4400 9700	2500 5500	—	—	3000* 6600*	1900 4150
2500 mm 8'2"	0.9 m ³ 1.17 yd ³	kg lb	12 400* 27,300*	12 300 27,100	8800* 19,400*	6300 13,850	6200* 13,650*	4200* 9250*	4500 9900	2600 5700	—	—	1400* 3050*	1400* 3050*
2900 mm 9'6"	0.81 m ³ 1.06 yd ³	kg lb	12 100* 26,650*	12 100* 26,650*	8600* 18,950*	6200 13,650	6000* 13,200*	4100 9000	4500* 9900*	2700 5950	—	—	1200* 2600*	1200* 2600*
4200 mm 13'9"	0.55 m ³ 0.72 yd ³	kg lb	10 800* 23,800*	10 800* 23,800*	7600* 16,750*	6100 13,450	5300* 11,650*	4000 8800	4200* 9250*	2800 6150	3300 7250	1900 4150	600* 1300*	600* 1300*

M320 ● 4-Point Stabilizers Down ● VA Boom @ 5.41 m (17'9") Max.

Stick	Bucket	3 m 10'0"		4.5 m 15'0"		6 m 20'0"		7.5 m 25'0"		9 m 30'0"		At Max. Reach		
		Front	Side	Front	Side	Front	Side	Front	Side	Front	Side	Front	Side	
1900 mm 6'3"	1.05 m ³ 1.37 yd ³	kg lb	12 800* 28,200*	12 800* 28,200*	8900* 19,600*	8900* 19,600*	6300* 13,850*	6000 13,200	4800* 10,550*	4000 8800	—	—	3000* 6600*	3000* 6600*
2500 mm 8'2"	0.9 m ³ 1.17 yd ³	kg lb	12 400* 27,300*	12 400* 27,300*	8800* 19,400*	8800* 19,400*	6200* 13,650*	5900 13,000	4800* 10,550*	4200 9250	—	—	1400* 3050*	1400* 3050*
2900 mm 9'6"	0.81 m ³ 1.06 yd ³	kg lb	12 100* 26,650*	12 100* 26,650*	8600* 18,950*	8600* 18,950*	6000* 13,200*	5800* 12,750*	4700* 10,350*	4200 9250	—	—	1200* 2600*	1200* 2600*
4200 mm 13'9"	0.55 m ³ 0.72 yd ³	kg lb	10 800* 23,800*	10 800* 23,800*	7600* 16,750*	7600* 16,750*	5300* 11,650*	5300* 11,650*	4200* 9250*	4100 9000	3400* 7450*	3000 6600	600* 1300*	600* 1300*

M320 ● Dozer and Stabilizer Down ● VA Boom @ 5.41 m (17'9") Max.

Stick	Bucket	3 m 10'0"		4.5 m 15'0"		6 m 20'0"		7.5 m 25'0"		9 m 30'0"		At Max. Reach		
		Front	Side	Front	Side	Front	Side	Front	Side	Front	Side	Front	Side	
1900 mm 6'3"	1.05 m ³ 1.37 yd ³	kg lb	12 800* 28,200*	12 800* 28,200*	8900* 19,600*	7900* 17,400*	6300* 13,850*	4900 10,800	4800* 10,550*	3300 7250	—	—	3000* 6600*	2600 5700
2500 mm 8'2"	0.9 m ³ 1.17 yd ³	kg lb	12 400* 27,300*	12 400* 27,300*	8800* 19,400*	7800 17,150	6200* 13,650*	5100 11,200	4800* 10,550*	3400 7450	—	—	1400* 3050*	1400* 3050*
2900 mm 9'6"	0.81 m ³ 1.06 yd ³	kg lb	12 100* 26,650*	12 100* 26,650*	8600* 18,950*	7700 16,950	6000* 13,200*	5000 11,000	4700* 10,350*	3500 7700	—	—	1200* 2600*	1200* 2600*
4200 mm 13'9"	0.55 m ³ 0.72 yd ³	kg lb	10 800* 23,800*	10 800* 23,800*	7600* 16,750*	7600* 16,750*	5300* 11,650*	4900 10,800	4200* 9250*	3500 7700	3400* 7450*	2500 5500	600* 1300*	600* 1300*

*Load limited by hydraulic capacity rather than tipping.

Japan Sourced

320B ● Reach Boom ● 600 mm (2'0") Track Shoes

Stick	Bucket		3 m 10'0"		4.5 m 15'0"		6 m 20'0"		7.5 m 25'0"		9 m 30'0"		At Max. Reach	
			Front	Side	Front	Side	Front	Side	Front	Side	Front	Side	Front	Side
1900 mm 6'3"	C1370X 4'6"	kg lb	—	—	7950 17,050	4650 10,000	4950 10,600	2950 6300	—	—	—	—	3000 6550	1750 3800
2500 mm 8'2"	B1260X 4'2"	kg lb	—	—	8350 17,950	5050 10,850	5300 11,350	3300 7050	3700 7950	2300 4900	—	—	2900 6350	1750 3900
2920 mm 9'7"	B1130X 3'8"	kg lb	5450*	5450*	8450 18,150	5150 11,050	5350 11,500	3350 7200	3800 8100	2350 5050	—	—	2400* 5300*	1700 3700
3860 mm 12'8"	B1130X 3'8"	kg lb	6850*	6850*	8600 18,450	5250 11,300	5450 11,650	3400 7350	3800 8200	2400 5150	2850 6100	1750 3700	2050* 4450*	1450 3150

320B ● Mass Boom ● 600 mm (2'0") Track Shoes

Stick	Bucket		3 m 10'0"		4.5 m 15'0"		6 m 20'0"		7.5 m 25'0"		9 m 30'0"		At Max. Reach	
			Front	Side	Front	Side	Front	Side	Front	Side	Front	Side	Front	Side
1900 mm 6'3"	C1470X 4'10"	kg lb	—	—	8100 17,350	4750 10,200	5000 10,750	3000 6400	—	—	—	—	3350 7300	1950 4300
2400 mm 7'10"	C1370X 4'6"	kg lb	7600*	7600*	8150 17,500	4800 10,350	5050 10,800	3050 6500	—	—	—	—	3000 6600	1750 3850

320B L ● Reach Boom ● 800 mm (2'8") Track Shoes

Stick	Bucket		3 m 10'0"		4.5 m 15'0"		6 m 20'0"		7.5 m 25'0"		9 m 30'0"		At Max. Reach	
			Front	Side	Front	Side	Front	Side	Front	Side	Front	Side	Front	Side
1900 mm 6'3"	C1470X 4'10"	kg lb	—	—	9600*	5550 11,850	6250 13,400	3500 7550	—	—	—	—	3800 8300	2100 4600
2500 mm 8'2"	B1370X 4'6"	kg lb	—	—	9900*	5950 12,750	6600 14,150	3850 8250	4600 9900	2700 5800	—	—	2950* 6500*	2050 4550
2920 mm 9'7"	B1260X 4'2"	kg lb	5350*	5350*	9750*	6000 12,850	6650 14,250	3900 8350	4650 9950	2750 5050	—	—	2400* 5200*	1950 4300
3860 mm 12'8"	B1130X 3'8"	kg lb	6850*	6850*	9200*	6150 13,200	6650 14,350	4000 8550	4750 10,150	2800 6050	3550 7550	2100 4450	2050* 4450*	1700 3750

320B L ● Mass Boom ● 800 mm (2'8") Track Shoes

Stick	Bucket		3 m 10'0"		4.5 m 15'0"		6 m 20'0"		7.5 m 25'0"		9 m 30'0"		At Max. Reach	
			Front	Side	Front	Side	Front	Side	Front	Side	Front	Side	Front	Side
1900 mm 6'3"	C1440MX 4'6"	kg lb	—	—	9700*	5650 12,100	6350 13,550	3550 7650	—	—	—	—	4200 9250	2350 5150
2400 mm 7'10"	C1470X 4'10"	kg lb	7600*	7600*	9600*	5700 12,250	6350 13,650	3600 7700	—	—	—	—	3800 8350	2150 4650

*Load limited by hydraulic capacity rather than tipping.

Excavators

Lifting Capacity At Ground Level

- 320B N ● 320B Belgium Sourced

Japan Sourced

320B N ● Reach Boom ● 500 mm (1'8") Track Shoes

Stick	Bucket	3 m 10'0"		4.5 m 15'0"		6 m 20'0"		7.5 m 25'0"		9 m 30'0"		At Max. Reach	
		Front	Side	Front	Side	Front	Side	Front	Side	Front	Side	Front	Side
1900 mm 6'3"	C1370X 4'6" kg lb	—	—	8500 18,200	4450 9550	5300 11,350	2850 6100	—	—	—	—	3200 7050	1700 3700
2500 mm 8'2"	B1260X 4'2" kg lb	—	—	8900 19,050	4850 10,400	5600 12,050	3200 6800	3950 8500	2250 4800	—	—	3100* 6850*	1750 3800
2920 mm 9'7"	B1130X 3'8" kg lb	5450* 12,500*	5450* 12,500*	9000 19,300	4950 10,600	5700 12,250	3250 6950	4050 8650	2300 4900	—	—	2400* 5300*	1650 3600
3860 mm 12'8"	B1130X 3'8" kg lb	6850* 15,750*	6850* 15,750*	9100 19,550	5050 10,800	5750 12,350	3300 7100	4050 8700	2350 4950	3050 6500	1700 3600	2050* 4450*	1400 3050

320B N ● Mass Boom ● 500 mm (1'8") Track Shoes

Stick	Bucket	3 m 10'0"		4.5 m 15'0"		6 m 20'0"		7.5 m 25'0"		9 m 30'0"		At Max. Reach	
		Front	Side	Front	Side	Front	Side	Front	Side	Front	Side	Front	Side
1900 mm 6'3"	C1470X 4'10" kg lb	—	—	8600 18,450	4550 9800	5350 11,450	2900 6200	—	—	—	—	3600 7850	1900 4150
2400 mm 7'10"	C1370X 4'6" kg lb	7600* 17,600*	7600* 17,600*	8700 18,600	4600 9900	5400 11,550	2950 6250	—	—	—	—	3250 7150	1700 3750

Belgium Sourced

320B ● Reach Boom ● 600 mm (2'0") Track Shoes

Stick	Bucket	3 m 10'0"		4.5 m 15'0"		6 m 20'0"		7.5 m 25'0"		9 m 30'0"		At Max. Reach	
		Front	Side	Front	Side	Front	Side	Front	Side	Front	Side	Front	Side
1.9 m 6'3"	1.15 m³ 1.5 yd³ kg lb	—	—	8480 18,690	5020 11,060	5330 11,750	3240 7140	—	—	—	—	2180 4800	1910 4210
2.5 m 8'2"	1.05 m³ 1.37 yd³ kg lb	—	—	8910 19,640	5430 11,970	5620 12,390	3530 7780	3950 8700	2480 5460	—	—	2960* 6520*	1880 4140
2.9 m 9'6"	0.8 m³ 1.04 yd³ kg lb	5300* 11,680*	5300* 11,680*	9000 19,840	5500 12,120	5670 12,500	3570 7870	3980 8770	2510 5530	—	—	2290* 5040*	1170 3900

320B ● Mass Boom ● 600 mm (2'0") Track Shoes

Stick	Bucket	3 m 10'0"		4.5 m 15'0"		6 m 20'0"		7.5 m 25'0"		9 m 30'0"		At Max. Reach	
		Front	Side	Front	Side	Front	Side	Front	Side	Front	Side	Front	Side
1.9 m 6'3"	1.25 m³ 1.63 yd³ kg lb	—	—	8740 19,270	5240 11,550	5470 12,060	3360 7400	—	—	—	—	3580 7890	2190 4820
2.4 m 7'10"	1.15 m³ 1.5 yd³ kg lb	7660* 16,890*	7660* 16,890*	8810 19,420	5300 11,680	5500 12,120	3390 7470	3810 8400	2330 5130	—	—	3250 7160	1980 4360

320B ● VA Boom ● 600 mm (2'0") Track Shoes

Stick	Bucket	3 m 10'0"		4.5 m 15'0"		6 m 20'0"		7.5 m 25'0"		9 m 30'0"		At Max. Reach	
		Front	Side	Front	Side	Front	Side	Front	Side	Front	Side	Front	Side
1.9 m 6'3"	1.15 m³ 1.5 yd³ kg lb	—	—	8530* 18,800*	4480 9870	5460 12,030	2900 6390	—	—	—	—	3250* 7160*	1760 3880
2.4 m 7'10"	0.95 m³ 1.24 yd³ kg lb	—	—	8810 19,430	4590 10,120	5540 12,210	2970 6540	3870 8530	2050 4520	—	—	3090 6810	1620 3570

*Load limited by hydraulic capacity rather than tipping.

Belgium Sourced

320B L ● Reach Boom ● 600 mm (2'0") Track Shoes

Stick	Bucket	3 m 10'0"		4.5 m 15'0"		6 m 20'0"		7.5 m 25'0"		9 m 30'0"		At Max. Reach		
		Front	Side	Front	Side	Front	Side	Front	Side	Front	Side	Front	Side	
1.9 m 6'3"	1.15 m ³ 1.5 yd ³	kg lb	—	—	9500* 20,940	5840 12,870	6580 14,500	3770 8310	—	—	—	—	3920 8640	2250 4960
2.5 m 8'2"	1.05 m ³ 1.37 yd ³	kg lb	—	—	9810* 21,630*	6250 13,780	6870 15,140	4060 8950	4820 10,620	2860 6300	—	—	2960* 6520*	2190 4820
2.9 m 9'6"	0.8 m ³ 1.04 yd ³	kg lb	5300* 11,680*	5300* 11,680*	9680* 21,340*	6330 13,950	6920* 15,250	4100 9040	4850 10,690	2900 6390	—	—	2290* 5040*	2060 4540

320B L ● Mass Boom ● 600 mm (2'0") Track Shoes

Stick	Bucket	3 m 10'0"		4.5 m 15'0"		6 m 20'0"		7.5 m 25'0"		9 m 30'0"		At Max. Reach		
		Front	Side	Front	Side	Front	Side	Front	Side	Front	Side	Front	Side	
1.9 m 6'3"	1.25 m ³ 1.63 yd ³	kg lb	—	—	9680* 21,340*	6070 13,380	6730 14,830	3900 8590	—	—	—	—	4390 9670	2560 5640
2.4 m 7'10"	1.15 m ³ 1.5 yd ³	kg lb	7660* 16,890*	7660* 16,890*	9590* 21,140*	6130 13,510	6760 14,900	3920 8640	4680 10,310	2720 5990	—	—	3810* 8400*	2310 5090

320B L ● VA Boom ● 600 mm (2'0") Track Shoes

Stick	Bucket	3 m 10'0"		4.5 m 15'0"		6 m 20'0"		7.5 m 25'0"		9 m 30'0"		At Max. Reach		
		Front	Side	Front	Side	Front	Side	Front	Side	Front	Side	Front	Side	
1.9 m 6'3"	1.15 m ³ 1.5 yd ³	kg lb	—	—	8530* 18,800*	5000 11,020	5370 11,840	3220 7100	—	—	—	—	3250* 7160*	1960 4320
2.4 m 7'10"	0.95 m ³ 1.24 yd ³	kg lb	—	—	8670 19,110	5100 11,240	5440 11,990	3290 7250	3800 8370	2280 5020	—	—	3030 6680	1800 3960

320B LN ● Reach Boom ● 500 mm (1'8") Track Shoes**

Stick	Bucket	3 m 10'0"		4.5 m 15'0"		6 m 20'0"		7.5 m 25'0"		9 m 30'0"		At Max. Reach		
		Front	Side	Front	Side	Front	Side	Front	Side	Front	Side	Front	Side	
1.9 m 6'3"	1.15 m ³ 1.5 yd ³	kg lb												
2.5 m 8'2"	1.05 m ³ 1.37 yd ³	kg lb												
2.9 m 9'6"	0.8 m ³ 1.04 yd ³	kg lb												

320B LN ● Mass Boom ● 500 mm (1'8") Track Shoes**

Stick	Bucket	3 m 10'0"		4.5 m 15'0"		6 m 20'0"		7.5 m 25'0"		9 m 30'0"		At Max. Reach		
		Front	Side	Front	Side	Front	Side	Front	Side	Front	Side	Front	Side	
1.9 m 6'3"	1.25 m ³ 1.63 yd ³	kg lb												
2.4 m 7'10"	1.15 m ³ 1.5 yd ³	kg lb												

*Load limited by hydraulic capacity rather than tipping.

**Information unavailable.

Excavators

Lifting Capacity At Ground Level

- 320B LN ● 320B S

Belgium Sourced

320B LN** ● VA Boom ● 500 mm (1'8") Track Shoes

Stick	Bucket	3 m 10'0"		4.5 m 15'0"		6 m 20'0"		7.5 m 25'0"		9 m 30'0"		At Max. Reach	
		Front	Side	Front	Side	Front	Side	Front	Side	Front	Side	Front	Side
1.9 m 6'3"	1.15 m ³ 1.5 yd ³	kg lb											
2.4 m 7'10"	0.95 m ³ 1.24 yd ³	kg lb											

320B S ● Reach Boom ● 550 mm (1'10") Track Shoes

Stick	Bucket	3 m 10'0"		4.5 m 15'0"		6 m 20'0"		7.5 m 25'0"		9 m 30'0"		At Max. Reach		
		Front	Side	Front	Side	Front	Side	Front	Side	Front	Side	Front	Side	
1.9 m 6'3"	1.15 m ³ 1.5 yd ³	kg lb	—	—	9490* 20,920	4760 10,490	6560 14,460	3110 6850	—	—	—	—	3960 8730	1860 4100
2.5 m 8'2"	1.05 m ³ 1.37 yd ³	kg lb	—	—	9820* 21,650*	5160 11,370	6850 15,100	3390 7470	4830 10,650	2400 5290	—	—	2980* 6570*	1840 4050
2.9 m 9'6"	0.8 m ³ 1.04 yd ³	kg lb	5450* 12,010*	5450* 12,010*	9710* 21,410*	5230 11,530	6900 15,210	3440 7580	4860 10,710	2430 5350	—	—	2300 5070	1730 3810

320B S ● Mass Boom ● 550 mm (1'10") Track Shoes

Stick	Bucket	3 m 10'0"		4.5 m 15'0"		6 m 20'0"		7.5 m 25'0"		9 m 30'0"		At Max. Reach		
		Front	Side	Front	Side	Front	Side	Front	Side	Front	Side	Front	Side	
1.9 m 6'3"	1.25 m ³ 1.63 yd ³	kg lb	—	—	9670* 2130*	4970 10,950	6700 14,770	3230 7120	—	—	—	—	4440 9790	2130 4690
2.4 m 7'10"	1.15 m ³ 1.5 yd ³	kg lb	7890* 17,390*	7890* 17,390*	9610* 21,190*	5020 11,060	6730 14,830	3250 7160	—	—	—	—	3840 8460	1920 4230

320B S ● VA Boom ● 550 mm (1'10") Track Shoes

Stick	Bucket	3 m 10'0"		4.5 m 15'0"		6 m 20'0"		7.5 m 25'0"		9 m 30'0"		At Max. Reach		
		Front	Side	Front	Side	Front	Side	Front	Side	Front	Side	Front	Side	
1.9 m 6'3"	1.15 m ³ 1.5 yd ³	kg lb	—	—	8470* 18,670*	4680 10,310	6250* 13,780*	3050 6720	—	—	—	—	3210* 7070*	1880 4140
2.4 m 7'10"	0.95 m ³ 1.24 yd ³	kg lb	—	—	8990* 19,820*	4780 10,530	6550* 14,440*	3110 6850	4680* 10,310*	2170 4780	—	—	3220* 7100*	1730 3810

*Load limited by hydraulic capacity rather than tipping.

**Information unavailable.

Japan/U.S. Sourced

322B ● Reach Boom ● 600 mm (2'0") Track Shoes

Stick	Bucket	3 m 10'0"		4.5 m 15'0"		6 m 20'0"		7.5 m 25'0"		9 m 30'0"		At Max. Reach	
		Front	Side	Front	Side	Front	Side	Front	Side	Front	Side	Front	Side
2500 mm 8'2"	S1355X 4'5" kg lb	—	—	10 500 22,450	6500 13,950	6550 14,050	4200 9000	4600 9850	2950 6350	—	—	3450 7550	2200 4800
2950 mm 9'8"	S1225X 4'0" kg lb	5200*	5200*	10 600 22,700	6600 14,150	6600 14,200	4250 9150	4650 9950	3000 6400	—	—	3200 7050	2050 4450
3600 mm 11'10"	B1260X 4'2" kg lb	6050*	6050*	10 650 22,800	6600 14,200	6650 14,250	4250 9150	4650 9950	3000 6400	3450 7350	2150 4600	2900 6400	1800 4000

322B ● Mass Boom ● 600 mm (2'0") Track Shoes

Stick	Bucket	3 m 10'0"		4.5 m 15'0"		6 m 20'0"		7.5 m 25'0"		9 m 30'0"		At Max. Reach	
		Front	Side	Front	Side	Front	Side	Front	Side	Front	Side	Front	Side
2000 mm 6'7"	D1345X 4'5" kg lb	—	—	10 200 21,850	6150 13,250	6250 13,400	3900 8350	—	—	—	—	3900 8600	2400 5250
2500 mm 8'2"	D1345X 4'5" kg lb	—	—	10 250 21,950	6200 13,300	6250 13,400	3900 8300	4300 9150	2600 5500	—	—	3500 7700	2100 4650

322B L ● Reach Boom ● 800 mm (2'8") Track Shoes

Stick	Bucket	3 m 10'0"		4.5 m 15'0"		6 m 20'0"		7.5 m 25'0"		9 m 30'0"		At Max. Reach	
		Front	Side	Front	Side	Front	Side	Front	Side	Front	Side	Front	Side
2500 mm 8'2"	S1315X 4'4" kg lb	—	—	12,150*	7650	8100 17,350	4950 10,550	5650 12,100	3500 7450	—	—	4200 9300	2600 5650
2950 mm 9'8"	S1355X 4'5" kg lb	5150*	5150*	12 000*	7700	8150 17,450	4950 10,650	5650 12,150	3500 7500	—	—	3700 8150	2400 5250
3600 mm 11'10"	B1260X 4'2" kg lb	6050*	6050*	11 600*	7750	8150 17,550	5000 10,700	5700 12,200	3500 7500	4250 9050	2600 5500	3150 6850	2200 4800

322B L ● Mass Boom ● 800 mm (2'8") Track Shoes

Stick	Bucket	3 m 10'0"		4.5 m 15'0"		6 m 20'0"		7.5 m 25'0"		9 m 30'0"		At Max. Reach	
		Front	Side	Front	Side	Front	Side	Front	Side	Front	Side	Front	Side
2000 mm 6'7"	D1500X 4'11" kg lb	—	—	11 750 25,350	7300 15,600	7750 16,650	4600 9800	—	—	—	—	4800 10,600	2850 6250
2500 mm 8'2"	D1430X 4'8" kg lb	—	—	11 550 24,950	7250 15,550	7750 16,550	4550 9750	5300 11,350	3100 6600	—	—	4350 9550	2550 5600

Belgium Sourced

322B L ● Reach Boom ● 800 mm (2'8") Track Shoes

Stick	Bucket	3 m 10'0"		4.5 m 15'0"		6 m 20'0"		7.5 m 25'0"		9 m 30'0"		At Max. Reach	
		Front	Side	Front	Side	Front	Side	Front	Side	Front	Side	Front	Side
2500 mm 8'2"	1.25 m ³ 1.63 yd ³ kg lb	—	—	11 980*	8040	8430 18,580	5180 11,420	5880 12,960	3650 8040	—	—	4310 9500	2670 5880
2950 mm 9'8"	1.15 m ³ 1.5 yd ³ kg lb	5050*	5050*	11 850*	8130	8430*	5220	5910 13,030	3680 8110	—	—	3560* 7840*	2480 5460

*Load limited by hydraulic capacity rather than tipping.

Excavators

Lifting Capacity At Ground Level

- 322B L ● 322B LN ● 325B

Belgium Sourced

322B L ● Mass Boom ● 800 mm (2'8") Track Shoes

Stick	Bucket	3 m (10'0")		4.5 m (15'0")		6 m (20'0")		7.5 m (25'0")		9 m (30'0")		At Max. Reach		
		Front	Side	Front	Side	Front	Side	Front	Side	Front	Side	Front	Side	
2000 mm 6'7"	1.5 m ³ 1.96 yd ³	kg lb	—	—	11 660* 25,710*	7770 17,130	8190 18,050	4910 10,820	—	—	—	—	4950* 10,910*	2970 6540
2500 mm 8'2"	1.45 m ³ 1.9 yd ³	kg lb	—	—	11 580* 25,530*	7860 17,330	8230 18,140	4940 10,890	5630 12,410	3380 7450	—	—	4100* 9040*	2690 5930

322B L ● VA Boom ● 800 mm (2'8") Track Shoes

Stick	Bucket	3 m (10'0")		4.5 m (15'0")		6 m (20'0")		7.5 m (25'0")		9 m (30'0")		At Max. Reach		
		Front	Side	Front	Side	Front	Side	Front	Side	Front	Side	Front	Side	
2 m 6'7"	1.5 m ³ 1.96 yd ³	kg lb	—	—	10 170* 22,420*	7430 16,380	7590* 16,730*	4720 10,400	5260* 11,590*	3260 7180	—	—	3540* 7800*	2590 5710
2.5 m 8'2"	1.45 m ³ 1.9 yd ³	kg lb	—	—	10 810* 23,830*	7520 16,580	7880* 17,370*	4750 10,470	5570 12,280	3270 7210	—	—	3500* 7710*	2340 5150

322B LN ● Reach Boom ● 600 mm (2'0") Track Shoes

Stick	Bucket	3 m (10'0")		4.5 m (15'0")		6 m (20'0")		7.5 m (25'0")		9 m (30'0")		At Max. Reach		
		Front	Side	Front	Side	Front	Side	Front	Side	Front	Side	Front	Side	
2.5 m 8'2"	1.15 m ³ 1.5 yd ³	kg lb	—	—	12 000* 26,460*	7030 15,500	8190 18,050	4550 10,030	5710 12,590	3210 7070	—	—	4190 9230	2340 5150
2.95 m 12'8"	0.95 m ³ 1.24 yd ³	kg lb	5130* 11,310*	5130* 11,310*	11 920 26,280	7160 15,780	8290 18,270	4640 10,230	5790 12,760	3280 7230	—	—	3620* 7980*	2210 4870

322B LN ● Mass Boom ● 600 mm (2'0") Track Shoes

Stick	Bucket	3 m (10'0")		4.5 m (15'0")		6 m (20'0")		7.5 m (25'0")		9 m (30'0")		At Max. Reach		
		Front	Side	Front	Side	Front	Side	Front	Side	Front	Side	Front	Side	
2 m 6'7"	1.45 m ³ 1.9 yd ³	kg lb	—	—	11 710* 25,820*	6780 14,940	7970 17,570	4300 9480	—	—	—	—	4830 10,650	2600 5730
2.5 m 8'2"	1.3 m ³ 1.7 yd ³	kg lb	—	—	11 600* 25,570*	6840 15,080	7990 17,610	4320 9520	5470 12,060	2940 6480	—	—	4120* 9080*	2330 5130

322B LN ● VA Boom ● 600 mm (2'0") Track Shoes

Stick	Bucket	3 m (10'0")		4.5 m (15'0")		6 m (20'0")		7.5 m (25'0")		9 m (30'0")		At Max. Reach		
		Front	Side	Front	Side	Front	Side	Front	Side	Front	Side	Front	Side	
2 m 6'7"	1.45 m ³ 1.9 yd ³	kg lb	—	—	10 230* 22,550*	6440 14,200	7640* 16,840*	4110 9060	5310* 11,700*	2830 6240	—	—	3600* 7930*	2250 4960
2.5 m 8'2"	1.3 m ³ 1.7 yd ³	kg lb	—	—	10 830* 23,880*	6500 14,330	7860 17,330	4120 9080	5400 11,900	2820 6210	—	—	3530* 7780*	2000 4410

Japan/U.S. Sourced

325B ● Reach Boom ● 600 mm (2'0") Track Shoes

Stick	Bucket	3 m 10'0"		4.5 m 15'0"		6 m 20'0"		7.5 m 25'0"		9 m 30'0"		At Max. Reach		
		Front	Side	Front	Side	Front	Side	Front	Side	Front	Side	Front	Side	
2000 mm 6'7"	D1430X 4'8"	kg lb	—	—	11 850 25,400	7150 15,350	7400 15,900	4650 9950	5200 11,150	3250 6950	—	—	3950 8700	2450 5400
2650 mm 8'8"	C1470X 4'10"	kg lb	—	—	12 400 26,500	7650 16,500	7750 16,650	5000 10,700	5450 11,750	3550 7600	—	—	3800 8350	2450 5300
3200 mm 10'6"	C1370X 4'6"	kg lb	4300* 9850*	4300* 9850*	12 450 26,700	7750 16,600	7800 16,750	5000 10,800	5500 11,750	3550 7600	4100 8750	2600 5550	3300* 7200*	2200 4800

325B ● Mass Boom ● 600 mm (2'0") Track Shoes

Stick	Bucket	3 m 10'0"		4.5 m 15'0"		6 m 20'0"		7.5 m 25'0"		9 m 30'0"		At Max. Reach		
		Front	Side	Front	Side	Front	Side	Front	Side	Front	Side	Front	Side	
2000 mm 6'7"	D1520MX 5'0"	kg lb	—	—	12 300 26,300	7500 16,150	7650 16,400	4850 10,400	—	—	—	—	4600 10,100	2900 6350
2500 mm 8'2"	D1500X 4'11"	kg lb	—	—	12 350 26,450	7550 16,250	7650 16,350	4850 10,350	5300 11,300	3550 7100	—	—	4150 9100	2600 5650

*Load limited by hydraulic capacity rather than tipping.

Japan/U.S. Sourced

325B L ● Reach Boom ● 800 mm (2'8") Track Shoes

Stick	Bucket	3 m 10'0"		4.5 m 15'0"		6 m 20'0"		7.5 m 25'0"		9 m 30'0"		At Max. Reach	
		Front	Side	Front	Side	Front	Side	Front	Side	Front	Side	Front	Side
2000 mm 6'7"	D1520MX 5'0" kg lb	—	—	14 100 31,100	8500 18,300	8950 19,150	5500 11,800	6250 13,400	3850 8300	—	—	4750 10,450	2950 6450
2650 mm 8'8"	C1440MX 4'9" kg lb	—	—	15 100 32,350	9050 19,450	9300 20,000	5850 12,600	6550 14,050	4150 8950	—	—	4100* 9050*	2900 6300
3200 mm 10'6"	C1470X 4'10" kg lb	4250* 9800*	4250* 9800*	15 200 32,500	9100 19,550	9350 20,050	5900 12,650	6550 14,050	4150 8950	4900 10,450	3100 6600	3250* 7150*	2600 5750

325B L ● Mass Boom ● 800 mm (2'8") Track Shoes

Stick	Bucket	3 m 10'0"		4.5 m 15'0"		6 m 20'0"		7.5 m 25'0"		9 m 30'0"		At Max. Reach	
		Front	Side	Front	Side	Front	Side	Front	Side	Front	Side	Front	Side
2000 mm 6'7"	D1700MX 5'7" kg lb	—	—	15 000 32,050	8850 19,000	9150 19,600	5650 12,150	—	—	—	—	5450 12,000	3400 7450
2500 mm 8'2"	D1520MX 5'0" kg lb	—	—	15 100 32,300	8950 19,200	9200 19,700	5700 12,200	6350 13,600	3950 8450	—	—	4700* 10,300*	3100 6750

Belgium Sourced

325B L ● Reach Boom ● 800 mm (2'8") Track Shoes

Stick	Bucket	3 m 10'0"		4.5 m 15'0"		6 m 20'0"		7.5 m 25'0"		9 m 30'0"		At Max. Reach	
		Front	Side	Front	Side	Front	Side	Front	Side	Front	Side	Front	Side
2 m 6'7"	1.45 m ³ 1.89 yd ³ kg lb	—	—	14 070* 31,020*	8730 19,240	9160 20,190	5630 12,410	6410 14,130	3970 8750	—	—	4790 10,560	2960 6520
2.65 m 8'8"	1.45 m ³ 1.9 yd ³ kg lb	—	—	15 080* 33,250*	9270 20,440	9530 21,010	6000 13,230	6690 14,750	4260 9390	—	—	3930* 8660*	2890 6370
3.2 m 10'6"	1.15 m ³ 1.5 yd ³ kg lb	4180* 9210*	4180* 9210*	15 460* 34,080*	9320 20,550	9560 21,070	6020 13,270	6700 14,770	4260 9390	5000 11,020	3160 6960	3130* 6900*	2630 5790

325B L ● Mass Boom ● 800 mm (2'8") Track Shoes

Stick	Bucket	3 m 10'0"		4.5 m 15'0"		6 m 20'0"		7.5 m 25'0"		9 m 30'0"		At Max. Reach	
		Front	Side	Front	Side	Front	Side	Front	Side	Front	Side	Front	Side
2 m 6'7"	1.7 m ³ 2.22 yd ³ kg lb	—	—	15 290 33,710	9030 19,910	9340 20,590	5770 12,720	—	—	—	—	5460 12,030	3390 7470
2.5 m 8'2"	1.5 m ³ 1.96 yd ³ kg lb	—	—	15 400 33,950	9120 20,100	9360 20,630	5790 12,760	6470 14,260	4010 8840	—	—	4450* 9810*	3070 6760

325B L ● VA Boom ● 800 mm (2'8") Track Shoes

Stick	Bucket	3 m 10'0"		4.5 m 15'0"		6 m 20'0"		7.5 m 25'0"		9 m 30'0"		At Max. Reach	
		Front	Side	Front	Side	Front	Side	Front	Side	Front	Side	Front	Side
2 m 6'7"	1.7 m ³ 2.22 yd ³ kg lb	—	—	13 040* 28,750*	8500 18,740	9040 19,930	5440 11,990	6290 13,860	3800 8370	—	—	4800* 10,580*	2950 6500
2.5 m 8'2"	1.45 m ³ 1.89 yd ³ kg lb	—	—	14 000* 30,870*	8610 18,980	9100 20,060	5490 12,100	6310 13,910	3820 8420	—	—	4240* 9340*	2700 5950

*Load limited by hydraulic capacity rather than tipping.

Excavators

Lifting Capacity At Ground Level

- 325B LN ● 330B

Belgium Sourced

325B LN ● Reach Boom ● 800 mm (2'8") Track Shoes

Stick	Bucket	3 m 10'0"		4.5 m 15'0"		6 m 20'0"		7.5 m 25'0"		9 m 30'0"		At Max. Reach		
		Front	Side	Front	Side	Front	Side	Front	Side	Front	Side	Front	Side	
2 m 6'7"	1.45 m ³ 1.89 yd ³	kg lb	—	—	14 070* 31,020*	7470 16,470	8790 19,380	4840 10,670	6140 13,530	3400 7490	—	—	4580 10,090	2510 5530
2.65 m 8'8"	1.15 m ³ 1.5 yd ³	kg lb	—	—	14 920 32,890	8020 17,680	9180 20,240	5220 11,510	6440 14,200	3700 8150	—	—	3950* 8700*	2500 5510
3.2 m 10'6"	0.95 m ³ 1.24 yd ³	kg lb	4260* 9390*	4260* 9390*	15 030 33,140	8120 17,900	9250 20,390	5290 11,660	6490 14,310	3750 8260	4850 10,690	2770 6100	3200* 7050*	2310 5090

325B LN ● Mass Boom ● 600 mm (2'0") Track Shoes

Stick	Bucket	3 m 10'0"		4.5 m 15'0"		6 m 20'0"		7.5 m 25'0"		9 m 30'0"		At Max. Reach		
		Front	Side	Front	Side	Front	Side	Front	Side	Front	Side	Front	Side	
2 m 6'7"	1.5 m ³ 1.96 yd ³	kg lb	—	—	14 770 32,560	7820 17,240	9030 19,910	5030 11,090	—	—	—	—	5290 11,660	2950 6500
2.5 m 8'2"	1.45 m ³ 1.89 yd ³	kg lb	—	—	14 860 32,760	7880 17,370	9030 19,910	5030 11,090	6240 13,750	3480 7670	—	—	4500* 9920*	2650 5840

325B LN ● VA Boom ● 600 mm (2'0") Track Shoes

Stick	Bucket	3 m 10'0"		4.5 m 15'0"		6 m 20'0"		7.5 m 25'0"		9 m 30'0"		At Max. Reach		
		Front	Side	Front	Side	Front	Side	Front	Side	Front	Side	Front	Side	
2 m 6'7"	1.7 m ³ 2.22 yd ³	kg lb	—	—	13 040* 28,750*	7220 15,920	8680 19,130	4630 10,200	6020 13,270	3210 7070	—	—	4700* 10,360*	2480 5460
2.5 m 8'2"	1.45 m ³ 1.89 yd ³	kg lb	—	—	14 000* 30,870*	7340 16,180	8730 19,240	4690 10,340	6040 13,310	3240 7140	—	—	4240* 9340*	2260 4980

Japan/U.S. Sourced

330B ● Reach Boom ● 600 mm (2'0") Track Shoes

Stick	Bucket	3 m 10'0"		4.5 m 15'0"		6 m 20'0"		7.5 m 25'0"		9 m 30'0"		At Max. Reach		
		Front	Side	Front	Side	Front	Side	Front	Side	Front	Side	Front	Side	
2150 mm 7'1"	E1470X 4'10"	kg lb	—	—	15 600 33,450	10 150 21,750	9700 20,800	6500 14,000	6800 14,600	4600 9850	—	—	4750 10,450	3200 6950
2800 mm 9'2"	D1500X 4'11"	kg lb	—	—	16 200 34,750	10 700 22,450	10 100 21,650	6900 14,850	7100 15,250	4900 10,500	5300 11,550	3600 7900	4650 10,200	3150 6900
3300 mm 10'10"	D1430X 4'8"	kg lb	7000* 15,900*	7000* 15,900*	16 300 34,900	10 750 23,050	10 100 21,750	6950 14,350	7100 15,250	4900 10,500	5300 11,650	3600 7700	4050* 8850*	2850 6250
3900 mm 12'10"	D1345X 4'5"	kg lb	7550* 17,200*	7550* 17,200*	16 400 35,200	10 850 23,300	10 200 21,900	7000 15,000	7150 15,300	4900 10,550	5300 11,350	3600 7700	3250* 7200*	2500 5550

330B ● Mass Boom ● 600 mm (2'0") Track Shoes

Stick	Bucket	3 m 10'0"		4.5 m 15'0"		6 m 20'0"		7.5 m 25'0"		9 m 30'0"		At Max. Reach		
		Front	Side	Front	Side	Front	Side	Front	Side	Front	Side	Front	Side	
2150 mm 7'1"	E1600X 5'3"	kg lb	—	—	16 000 34,250	10 450 22,450	9900 21,250	6700 14,400	6900 14,850	4700 10,100	—	—	5200 11,400	3500 7700
2550 mm 8'4"	E1470X 4'10"	kg lb	—	—	16 100 34,500	10 550 22,650	9950 21,300	6750 14,450	6900 14,800	4700 10,050	—	—	4700 10,350	3150 6900

*Load limited by hydraulic capacity rather than tipping.

Japan/U.S. Sourced

330B L ● Reach Boom ● 750 mm (2'6") Track Shoes

Stick	Bucket	3 m 10'0"		4.5 m 15'0"		6 m 20'0"		7.5 m 25'0"		9 m 30'0"		At Max. Reach		
		Front	Side	Front	Side	Front	Side	Front	Side	Front	Side	Front	Side	
2150 mm 7'1"	E1470X 4'10"	kg lb	—	—	16 900* 36,600*	10 600 22,700	12 100 25,950	6800 14,650	8450 18,100	4800 10,350	—	—	5900 13,000	3350 7350
2800 mm 9'2"	D1520MX 5'0"	kg lb	—	—	17 500* 37,900*	11 100 23,850	12 450 26,750	7200 15,400	8700 18,650	5100 10,900	6500 13,900	3750 8050	5600 12,350	3250 7150
3300 mm 10'10"	D1500X 4'11"	kg lb	6950* 15,900*	6950* 15,900*	17 350* 37,550*	11 150 24,000	12 350* 26,700*	7200 15,500	8700 18,700	5100 10,900	6500 13,900	3800 8050	4100* 9000*	3000 6600
3900 mm 12'10"	D1345X 4'5"	kg lb	7550* 17,200*	7550* 17,200*	16 950* 36,600*	11 300 24,250	12 000* 25,950*	7300 15,650	8750 18,800	5150 11,050	6500 13,950	3800 8100	3250* 7200*	2650 5850

330B L ● Mass Boom ● 750 mm (2'6") Track Shoes

Stick	Bucket	3 m 10'0"		4.5 m 15'0"		6 m 20'0"		7.5 m 25'0"		9 m 30'0"		At Max. Reach		
		Front	Side	Front	Side	Front	Side	Front	Side	Front	Side	Front	Side	
2150 mm 7'1"	E1735MX 5'8"	kg lb	—	—	17 100 37,100	10 800 23,250	12 250 26,250	6950 14,900	8500 18,200	4850 10,400	—	—	6350 13,950	3600 7900
2550 mm 8'4"	E1600X 5'3"	kg lb	—	—	17 250 37,350	10 950 23,450	12 300 26,350	7000 15,000	8500 18,200	4850 10,450	—	—	5650* 12,400*	3250 7150

Belgium Sourced

330B L ● Reach Boom ● 750 mm (2'6") Track Shoes

Stick	Bucket	3 m 10'0"		4.5 m 15'0"		6 m 20'0"		7.5 m 25'0"		9 m 30'0"		At Max. Reach		
		Front	Side	Front	Side	Front	Side	Front	Side	Front	Side	Front	Side	
2.2 m 7'3"	1.7 m ³ 2.2 yd ³	kg lb	—	—	17 110* 37,720*	12 120 26,720	12 530* 27,620*	7800 17,190	8920 19,660	5540 12,210	—	—	6210 13,690	3840 8460
2.8 m 9'2"	1.5 m ³ 1.96 yd ³	kg lb	—	—	17 620* 38,850*	12 490 27,540	12 660* 27,910*	8050 17,750	9110 20,080	5730 12,630	6810 15,010	4270 9410	5470* 12,060*	3590 7910
3.3 m 10'10"	1.45 m ³ 1.89 yd ³	kg lb	6660* 14,680*	6660* 14,680*	17 510* 38,600*	12 570 27,710	12 460* 27,470*	8100 17,860	9140 20,150	5750 12,670	6820 15,030	4280 9430	3800* 8370*	3320 7320
3.9 m 12'9"	1.3 m ³ 1.7 yd ³	kg lb	7280* 16,050*	7280* 16,050*	17 070* 37,630*	12 660 27,910	12 080* 26,630*	8140 17,940	9150 20,170	5760 12,700	6810 15,010	4270 9410	3160* 6960*	2980 6570

330B L ● Mass Boom ● 750 mm (2'6") Track Shoes

Stick	Bucket	3 m 10'0"		4.5 m 15'0"		6 m 20'0"		7.5 m 25'0"		9 m 30'0"		At Max. Reach		
		Front	Side	Front	Side	Front	Side	Front	Side	Front	Side	Front	Side	
2.2 m 7'3"	1.9 m ³ 2.4 yd ³	kg lb	—	—	17 460* 38,490*	12 490 27,540	12 720* 28,040*	8010 17,660	9050 19,950	5650 12,450	—	—	6740 14,860	4200 9260
2.6 m 8'6"	1.7 m ³ 2.2 yd ³	kg lb	—	—	17 600* 38,800*	12 560 27,690	12 650* 27,890*	8030 17,700	9050 19,950	5650 12,450	—	—	5570* 12,280*	3820 8420

*Load limited by hydraulic capacity rather than tipping.

Excavators

Lifting Capacity At Ground Level

- 330B LN
- 345B

Belgium Sourced

330B LN ● Reach Boom ● 600 mm (2'0") Track Shoes

Stick	Bucket	3 m 10'0"		4.5 m 15'0"		6 m 20'0"		7.5 m 25'0"		9 m 30'0"		At Max. Reach		
		Front	Side	Front	Side	Front	Side	Front	Side	Front	Side	Front	Side	
2.2 m 7'3"	1.7 m ³ 2.2 yd ³	kg lb	—	—	17 110* 37,720*	11 240 24,780	12 530* 27,620*	7300 16,090	9080 20,020	5190 11,440	—	—	6330 13,950	3600 7930
2.8 m 9'2"	1.5 m ³ 1.96 yd ³	kg lb	—	—	17 620* 38,850*	11 600 25,570	12 660* 27,910*	7540 16,620	9270 20,440	5380 11,860	6930 15,280	4010 8840	5470* 12,060*	3370 7430
3.3 m 10'10"	1.45 m ³ 1.89 yd ³	kg lb	6660* 14,680*	6660* 14,680*	17 510* 38,600*	11 670 25,730	12 460* 27,470*	7590 16,730	9290 20,480	5400 11,900	6940 15,300	4020 8860	3800* 8370*	3110 6850
3.9 m 12'9"	1.3 m ³ 1.7 yd ³	kg lb	7280* 16,050*	7280* 16,050*	17 070* 37,630*	11 760 25,930	12 080* 26,630*	7620 16,800	9310 20,520	5410 11,920	6930 10,870	4010 8840	3160* 6960*	2790 6150

330B LN ● Mass Boom ● 600 mm (2'0") Track Shoes

Stick	Bucket	3 m 10'0"		4.5 m 15'0"		6 m 20'0"		7.5 m 25'0"		9 m 30'0"		At Max. Reach		
		Front	Side	Front	Side	Front	Side	Front	Side	Front	Side	Front	Side	
2.2 m 7'3"	1.9 m ³ 2.4 yd ³	kg lb	—	—	17 460* 38,490*	11 590 25,550	12 720* 28,040*	7500 16,530	9210 20,300	5310 11,700	—	—	6860 15,120	3940 8680
2.6 m 8'6"	1.7 m ³ 2.2 yd ³	kg lb	—	—	17 600* 38,800*	11 660 25,700	12 650* 27,390*	7520 16,580	9210 20,300	5310 11,700	—	—	5570* 12,280*	3590 7910

Japan Sourced

345B ● Reach Boom ● 600 mm (2'0") Track Shoes

Stick	Bucket	3 m 10'0"		4.5 m 15'0"		6 m 20'0"		7.5 m 25'0"		
		Front	Side	Front	Side	Front	Side	Front	Side	
2900 mm 9'6"	F1590X 5'3"	kg lb	—	—	18 100* 42,150*	15 150 32,500	15 650* 33,650*	9700 20,900	11 050 23,650	6900 14,750
3350 mm 10'0"	T1580X 5'3"	kg lb	—	—	19 250* 44,700*	15 350 33,000	15 650* 33,800*	9850 21,200	11 100 23,850	7000 14,950
3900 mm 12'10"	F1218T 4'0"	kg lb	7750* 17,600*	7750* 17,600*	21 600* 47,700*	15 800 33,950	15 600* 33,700*	10 150 21,850	11 350 24,350	7200 15,400

Stick	Bucket	9 m 30'0"		10.5 m 35'0"		At Max. Reach		
		Front	Side	Front	Side	Front	Side	
2900 mm 9'6"	F1590X 5'3"	kg lb	8200 17,600	5100 10,900	—	—	5650* 12,400*	3850 8500
3350 mm 10'0"	T1580X 5'3"	kg lb	8250 17,750	5150 11,050	—	—	4900* 10,750*	3650 8000
3900 mm 12'10"	F1218T 4'0"	kg lb	8450 18,100	5300 11,400	6500 14,150	4000 8850	4800* 10,500*	3450 7600

345B ● Mass Boom ● 600 mm (2'0") Track Shoes

Stick	Bucket	3 m 10'0"		4.5 m 15'0"		6 m 20'0"		7.5 m 25'0"		
		Front	Side	Front	Side	Front	Side	Front	Side	
2500 mm 8'2"	G1770X 5'10"	kg lb	—	—	20 750* 42,150*	14 600 32,500	15 100* 33,650*	9300 20,900	10650 23,650	6450 14,750
3000 mm 9'10"	U1830V 5'9"	kg lb	—	—	20 950* 45,350*	14 650 31,400	14 900* 32,200*	9250 19,850	10 600 22,650	6400 13,650

Stick	Bucket	9 m 30'0"		10.5 m 35'0"		At Max. Reach		
		Front	Side	Front	Side	Front	Side	
2500 mm 8'2"	G1770X 5'10"	kg lb	—	—	—	—	6700 14,750	3950 8650
3000 mm 9'10"	U1830V 5'9"	kg lb	7700 16,500	4550 9700	—	—	5600* 12,300*	3550 7750

*Load limited by hydraulic capacity rather than tipping.

Japan/U.S. Sourced

345B L – FIX ● Reach Boom ● 750 mm (2'6") Track Shoes

Stick	Bucket		3 m 10'0"		4.5 m 15'0"		6 m 20'0"		7.5 m 25'0"	
			Front	Side	Front	Side	Front	Side	Front	Side
2900 mm 9'6"	F1735X 5'8"	kg lb	—	—	18 000* 41,900*	15 700 33,750	15 600* 33,700*	10 100 21,650	11 950* 25,800*	7150 15,300
3350 mm 11'0"	F1590X 5'3"	kg lb	—	—	19 200* 44,600*	15 950 34,300	15 600* 33,700*	10 250 22,050	11 950* 25,800*	7250 15,600
3900 mm 12'10"	F1218T 4'0"	kg lb	7750* 17,600*	7750* 17,600*	21 600* 47,700*	16 450 35,300	15 600* 33,700*	10 600 22,750	11 950* 25,850*	7500 16,100

Stick	Bucket		9 m 30'0"		10.5 m 35'0"		At Max. Reach	
			Front	Side	Front	Side	Front	Side
2900 mm 9'6"	F1735X 5'8"	kg lb	9550 20,450	5300 11,300	—	—	5500* 12,200*	4000 8800
3350 mm 11'0"	F1590X 5'3"	kg lb	9600* 20,650	5350 11,500	—	—	4800* 10,500*	3800 8300
3900 mm 12'10"	F1218T 4'0"	kg lb	9700* 20,900*	5550 11,950	7050* 15,300*	4250 9300	4800* 10,500*	3650 8000

345B L – FIX ● Mass Boom ● 750 mm (2'6") Track Shoes

Stick	Bucket		3 m 10'0"		4.5 m 15'0"		6 m 20'0"		7.5 m 25'0"	
			Front	Side	Front	Side	Front	Side	Front	Side
2500 mm 8'2"	G1770X 5'10"	kg lb	—	—	20 750* 45,050*	15 250 32,750	15 100* 32,650*	9700 20,850	11 500* 24,850*	6800 14,550
3000 mm 9'10"	U1830V 6'0"	kg lb	—	—	20 950* 45,350*	15 250 32,800	14 900* 32,200*	9650 20,750	11 350* 24,450*	6700 14,350

Stick	Bucket		9 m 30'0"		10.5 m 35'0"		At Max. Reach	
			Front	Side	Front	Side	Front	Side
2500 mm 8'2"	G1770X 5'10"	kg lb	—	—	—	—	7100* 15,650*	4150 9150
3000 mm 9'10"	U1830V 6'0"	kg lb	8950* 19,200*	4800 10,250	—	—	5600* 12,300*	3750 8250

*Load limited by hydraulic capacity rather than tipping.

Excavators

Lifting Capacity At Ground Level

● 345B L – VG

U.S. Sourced

345B L – VG ● Reach Boom ● 600 mm (2'0") Track Shoes

Stick	Bucket		3 m 10'0"		4.5 m 15'0"		6 m 20'0"		7.5 m 25'0"	
			Front	Side	Front	Side	Front	Side	Front	Side
2900 mm 9'6"	F1735X 5'8"	kg lb	—	—	18 600* 43,200*	18 600* 40,550	15 600* 33,750*	12 050 25,950	11 950* 25,800*	8600 18,450
3350 mm 11'0"	F1590X 5'3"	kg lb	—	—	19 550* 45,350*	19 150 41,100	15 650* 33,800*	12 250 26,350	12 000* 25,900*	8700 18,700
3900 mm 12'10"	F1410T 4'8"	kg lb	8050* 18,300*	8050* 18,300*	21 500* 47,450*	19 450 41,800	15 500* 33,550*	12 450 26,750	11 850* 25,650*	8850 18,950

Stick	Bucket		9 m 30'0"		10.5 m 35'0"		At Max. Reach	
			Front	Side	Front	Side	Front	Side
2900 mm 9'6"	F1735X 5'8"	kg lb	9550* 20,550*	6450 13,800	—	—	5650* 12,400*	5000 11,000
3350 mm 11'0"	F1590X 5'3"	kg lb	9600* 20,750*	6500 13,950	—	—	4850* 10,650*	4700 10,400
3900 mm 12'10"	F1410T 4'8"	kg lb	9550* 20,650*	6600 14,100	6650* 14,650*	5050 11,100	4700* 10,350*	4400 9650

345B L – VG ● Mass Boom ● 600 mm (2'0") Track Shoes

Stick	Bucket		3 m 10'0"		4.5 m 15'0"		6 m 20'0"		7.5 m 25'0"	
			Front	Side	Front	Side	Front	Side	Front	Side
2500 mm 8'2"	G1770X 5'10"	kg lb	—	—	21 000* 45,450*	18 550 39,750	15 000* 32,400*	11 750 25,200	11 400* 24,600*	8200 17,600
3000 mm 9'10"	G1895M 6'0"	kg lb	—	—	20 600* 44,700*	18 400 39,450	15 000* 32,400*	11 650 25,000	11 400* 24,600*	8150 17,500

Stick	Bucket		9 m 30'0"		10.5 m 35'0"		At Max. Reach	
			Front	Side	Front	Side	Front	Side
2500 mm 8'2"	G1770X 5'10"	kg lb	8950* 19,250*	6000 12,900	—	—	7100* 15,650*	4150 9150
3000 mm 9'10"	G1895M 6'0"	kg lb	—	—	—	—	7150* 15,750*	5200 11,400

*Load limited by hydraulic capacity rather than tipping.

Belgium Sourced**

345B L – VG ● Reach Boom ● 600 mm (2'0") Track Shoes

Stick	Bucket		3 m 10'0"		4.5 m 15'0"		6 m 20'0"		7.5 m 25'0"	
			Front	Side	Front	Side	Front	Side	Front	Side
2900 mm 9'6"	F1735X 5'8"	kg lb								
3350 mm 11'0"	F1590X 5'3"	kg lb								
3900 mm 12'10"	F1410T 4'8"	kg lb								

Stick	Bucket		9 m 30'0"		10.5 m 35'0"		At Max. Reach	
			Front	Side	Front	Side	Front	Side
2900 mm 9'6"	F1735X 5'8"	kg lb						
3350 mm 11'0"	F1590X 5'3"	kg lb						
3900 mm 12'10"	F1410T 4'8"	kg lb						

345B L – VG ● Mass Boom ● 600 mm (2'0") Track Shoes

Stick	Bucket		3 m 10'0"		4.5 m 15'0"		6 m 20'0"		7.5 m 25'0"	
			Front	Side	Front	Side	Front	Side	Front	Side
2500 mm 8'2"	G1770X 5'10"	kg lb								
3000 mm 9'10"	G1895M 6'0"	kg lb								

Stick	Bucket		9 m 30'0"		10.5 m 35'0"		At Max. Reach	
			Front	Side	Front	Side	Front	Side
2500 mm 8'2"	G1770X 5'10"	kg lb						
3000 mm 9'10"	G1895M 6'0"	kg lb						

**Information unavailable.

Japan Sourced

350 ● Reach Boom ● 600 mm (2'0") Triple Grousers

Stick	Bucket		3 m 10'0"		4.5 m 15'0"		6 m 20'0"		7.5 m 25'0"	
			Front	Side	Front	Side	Front	Side	Front	Side
4800 mm 15'9"	F1075T 3'6"	kg lb	5950* 13,500*	5950* 13,500*	16 600* 38,500*	16 600* 38,500*	14 250* 30,800*	11 700* 25,100	10 850* 23,450*	8250 17,700
3600 mm 11'10"	F1410T 4'8"	kg lb	—	—	13 850* 32,100*	13 850* 32,100*	15 150* 32,700*	11 450* 24,650	11 550* 24,750	8150 17,450
3100 mm 10'2"	F1590X 5'3"	kg lb	—	—	12 500* 29,200*	12 500* 29,200*	15 300* 33,050*	11 350* 24,400	11 450* 24,600	8050 17,300

Stick	Bucket		9 m 30'0"		10.5 m 35'0"		At Max. Reach	
			Front	Side	Front	Side	Front	Side
4800 mm 15'9"	F1075T 3'6"	kg lb	8700 18,650	6150 13,150	6700 14,400	4700 10,000	2900* 6400*	2900* 6400*
3600 mm 11'10"	F1410T 4'8"	kg lb	8600 18,450	6050 13,000	6650 12,250*	4650 9900	3750* 8250*	3750* 8250*
3100 mm 10'2"	F1590X 5'3"	kg lb	8600 18,400	6050 12,900	—	—	5300* 11,700*	4250 9350

350 ● Mass Boom ● 600 mm (2'0") Triple Grousers

Stick	Bucket		3 m 10'0"		4.5 m 15'0"		6 m 20'0"		7.5 m 25'0"	
			Front	Side	Front	Side	Front	Side	Front	Side
3700 mm 12'2"	F1590X 5'3"	kg lb	6950* 15,800*	6950* 15,800*	19 800* 46,000*	18 350* 39,350*	15 050* 32,500*	11 600* 24,850	11 500* 24,800*	8150 17,450
2950 mm 9'8"	G1655X 5'5"	kg lb	—	—	16 550* 43,250	17 850* 38,300	15 050* 32,550*	11 200* 24,100	11 250* 24,200	7850 16,850
2400 mm 7'10"	G1770X 5'10"	kg lb	—	—	18 300* 42,800*	17 550* 37,650	15 000* 32,450*	11 050* 23,700	11 200* 24,000	7750 16,700

Stick	Bucket		9 m 30'0"		10.5 m 35'0"		At Max. Reach	
			Front	Side	Front	Side	Front	Side
3700 mm 12'2"	F1590X 5'3"	kg lb	8600 18,400	6000 12,850	—	—	2800* 6200*	2800* 6200*
2950 mm 9'8"	G1655X 5'5"	kg lb	8350 17,850	5750 12,350	—	—	4450* 9800*	4450 9750
2400 mm 7'10"	G1770X 5'10"	kg lb	—	—	—	—	6500* 14,350*	4900 10,800*

*Load limited by hydraulic capacity rather than tipping.

Japan Sourced

350 Heavy Lift ● Reach Boom ● 600 mm (2'0") Triple Grousers

Stick	Bucket		3 m 10'0"		4.5 m 15'0"		6 m 20'0"		7.5 m 25'0"	
			Front	Side	Front	Side	Front	Side	Front	Side
4800 mm 15'9"	F1075T 3'6"	kg lb	6450* 14,650*	6450* 14,650*	17 750* 41,250*	17 750* 39,450*	16 150* 34,900*	11 700 25,100	11 650 25,050	8250 17,700
3600 mm 11'10"	F1410T 4'8"	kg lb	—	—	14 850* 34,400*	14 850* 34,400*	16 500 35,350	11 450 24,650	11 550 24,750	8150 17,450
3100 mm 10'2"	F1590X 5'3"	kg lb	—	—	13 450* 31,300*	13 450* 31,300*	16 350 35,050	11 350 24,400	11 450 24,600	8050 17,300

Stick	Bucket		9 m 30'0"		10.5 m 35'0"		At Max. Reach	
			Front	Side	Front	Side	Front	Side
4800 mm 15'9"	F1075T 3'6"	kg lb	8700 18,650	6150 13,150	6700 14,400	4700 10,000	3350* 7400*	3300 7200
3600 mm 11'10"	F1410T 4'8"	kg lb	8600 18,450	6050* 13,000	6650 13,800*	4650 9900	4300* 9400*	3900 8600
3100 mm 10'2"	F1590X 5'3"	kg lb	8600 18,400	6050 12,900	—	—	6000* 13,200*	4250 9350

350 Heavy Lift ● Mass Boom ● 600 mm (2'0") Triple Grousers

Stick	Bucket		3 m 10'0"		4.5 m 15'0"		6 m 20'0"		7.5 m 25'0"	
			Front	Side	Front	Side	Front	Side	Front	Side
3700 mm 12'2"	F1590X 5'3"	kg lb	7550* 17,100*	7550* 17,100*	21 200* 49,250*	18 350 39,350	16 600 35,650	11 600 24,850	11 550 24,800	8150 17,450
2950 mm 9'8"	G1655X 5'5"	kg lb	—	—	19 900* 46,350*	17 850 38,300	16 250 34,650	11 200 24,100	11 250 24,200	7850 16,850
2400 mm 7'10"	G1770X 5'10"	kg lb	—	—	19 600* 45,800*	17 550 37,650	16 050 34,450	11 050 23,700	11 200 24,000	7750 16,700

Stick	Bucket		9 m 30'0"		10.5 m 35'0"		At Max. Reach	
			Front	Side	Front	Side	Front	Side
3700 mm 12'2"	F1590X 5'3"	kg lb	8600 18,400	6000 12,850	—	—	3300* 7200*	3300* 7200*
2950 mm 9'8"	G1655X 5'5"	kg lb	8350 17,850	5750 12,350	—	—	5100* 11,150*	4450 9750
2400 mm 7'10"	G1770X 5'10"	kg lb	—	—	—	—	7150 15,700	4900 10,800

*Load limited by hydraulic capacity rather than tipping.

Japan Sourced

350 L ● Reach Boom ● 750 mm (2'6") Triple Grousers

Stick	Bucket		3 m 10'0"		4.5 m 15'0"		6 m 20'0"		7.5 m 25'0"	
			Front	Side	Front	Side	Front	Side	Front	Side
4800 mm 15'9"	F1218T 4'0"	kg lb	5850* 13,250*	5850* 13,250*	16 500* 38,250*	16 500* 38,250*	14 200* 30,600*	12 100 25,950	10 800* 23,300*	8550 18,300
3600 mm 11'10"	F1410T 4'8"	kg lb	—	—	13 850* 32,100*	13 850* 32,100*	15 150* 32,700*	11 950 25,650	11 550* 24,900*	8450 18,200
3100 mm 10'2"	F1735X 5'3"	kg lb	—	—	12 450* 29,000*	12 450* 29,000*	15 250* 32,950*	11 750 25,300	11 650* 25,150*	8350 17,950

Stick	Bucket		9 m 30'0"		10.5 m 35'0"		At Max. Reach	
			Front	Side	Front	Side	Front	Side
4800 mm 15'9"	F1218T 4'0"	kg lb	8700* 18,850*	6350 13,550	7350* 15,900*	4850 10,300	2850* 6200*	2850* 6200*
3600 mm 11'10"	F1410T 4'8"	kg lb	9300* 20,050*	6350 13,550	7250* 12,250*	4850 10,400	3750* 8250*	3750* 8250*
3100 mm 10'2"	F1735X 5'3"	kg lb	9350* 20,200*	6250 13,400	—	—	5250* 11,550*	4400 9700

350 L ● Mass Boom ● 750 mm (2'6") Triple Grousers

Stick	Bucket		3 m 10'0"		4.5 m 15'0"		6 m 20'0"		7.5 m 25'0"	
			Front	Side	Front	Side	Front	Side	Front	Side
3700 mm 12'2"	F1735X 5'8"	kg lb	6900* 15,650*	6900* 15,650*	19 700* 45,800*	19 000 40,750*	15 000* 32,400*	12 000 25,750	11 450* 24,700*	8450 18,100
2950 mm 9'8"	G1770X 5'10"	kg lb	—	—	18 450* 43,050*	18 450 39,550	14 950 32,300*	11 600 24,900	11 350* 24,550*	8100 17,400
2400 mm 7'10"	G1895M 6'3"	kg lb	—	—	18 050* 42,250*	18 050* 39,050*	14 900* 32,250*	11 450 24,600	11 400* 24,550*	8050 17,250

Stick	Bucket		9 m 30'0"		10.5 m 35'0"		At Max. Reach	
			Front	Side	Front	Side	Front	Side
3700 mm 12'2"	F1735X 5'8"	kg lb	9200* 19,900*	6250 13,350	—	—	2750* 6050*	2750* 6050*
2950 mm 9'8"	G1770X 5'10"	kg lb	9000* 19,450*	5950 12,750	—	—	4350* 9600*	4350* 9600*
2400 mm 7'10"	G1895M 6'3"	kg lb	—	—	—	—	6450* 14,150*	5050 11,150

*Load limited by hydraulic capacity rather than tipping.

Japan Sourced

350 L Heavy Lift ● Reach Boom ● 750 mm (2'6") Triple Grousers

Stick	Bucket		3 m 10'0"		4.5 m 15'0"		6 m 20'0"		7.5 m 25'0"	
			Front	Side	Front	Side	Front	Side	Front	Side
4800 mm 15'9"	F1218T 4'0"	kg lb	6350* 14,400*	6350* 14,400*	17 650* 41,000*	17 650* 40,800*	16 050* 34,700*	12 100 25,950	12 300* 26,550*	8550 18,300
3600 mm 11'10"	F1410T 4'8"	kg lb	—	—	14 850* 34,400*	14 850* 34,400*	17 150* 37,050	11 950 25,650	13 100* 28,350*	8450 18,200
3100 mm 10'2"	F1735X 5'3"	kg lb	—	—	13 350* 31,150*	13 350* 31,150*	17 250* 37,300*	11 750 25,300	13 200* 28,600*	8350 17,950

Stick	Bucket		9 m 30'0"		10.5 m 35'0"		At Max. Reach	
			Front	Side	Front	Side	Front	Side
4800 mm 15'9"	F1218T 4'0"	kg lb	10 000* 21,600*	6350 13,550	8150 17,500	4850 10,300	3300* 7200*	3300* 7200*
3600 mm 11'10"	F1410T 4'8"	kg lb	10 550 22,600	6350 13,550	8100* 13,800*	4850 10,400	4300* 9400*	4100 9050
3100 mm 10'2"	F1735X 5'3"	kg lb	10 450 22,450	6250 13,400	—	—	5950* 13,050*	4400 9700

350 L Heavy Lift ● Mass Boom ● 750 mm (2'6") Triple Grousers

Stick	Bucket		3 m 10'0"		4.5 m 15'0"		6 m 20'0"		7.5 m 25'0"	
			Front	Side	Front	Side	Front	Side	Front	Side
3700 mm 12'2"	F1735X 5'8"	kg lb	7450* 16,950*	7450* 16,950*	21 100* 49,050*	19 000 40,750	16 950* 36,660*	12 000 25,750	13 000* 28,100*	8450 18,100
2950 mm 9'8"	G1770X 5'10"	kg lb	—	—	19 800 46,100*	18 450 39,550	16 950* 36,700*	11 600 24,900	12 950* 28,000*	8100 17,400
2400 mm 7'10"	G1895M 6'3"	kg lb	—	—	19 350* 45,250*	18 200 39,050	16 950* 36,650*	11 450 24,600	13 000* 28,050*	8050 17,250

Stick	Bucket		9 m 30'0"		10.5 m 35'0"		At Max. Reach	
			Front	Side	Front	Side	Front	Side
3700 mm 12'2"	F1735X 5'8"	kg lb	10 450 22,450	6250 13,350	—	—	3200* 7050*	3200* 7050*
2950 mm 9'8"	G1770X 5'10"	kg lb	10 200 21,850	5950 12,750	—	—	5000* 10,950*	4600 10,050
2400 mm 7'10"	G1895M 6'3"	kg lb	—	—	—	—	7250* 15,950*	5050 11,150

*Load limited by hydraulic capacity rather than tipping.

Japan/U.S. Sourced

375 ● Reach Boom ● 610 mm (2'0") Double Grousers

Stick	Bucket		4.5 m 15'0"		6 m 20'0"		7.5 m 25'0"		9 m 30'0"	
			Front	Side	Front	Side	Front	Side	Front	Side
5500 mm 18'1"	H1380T 4'6"	kg lb	10 400* 24,050*	10 400* 24,050*	27 400* 59,200*	23 650 50,850	20 850* 45,000*	16 800 36,100	16 650* 36,000*	12 650 27,150
4400 mm 14'5"	H1800X 5'10"	kg lb	9600* 22,250*	9600* 22,250*	25 900* 59,200*	22 850 49,100	21 050* 45,500*	16 200 34,850	16 900* 36,450*	12 250 26,300
3400 mm 11'2"	J1780X 5'10"	kg lb	—	—	20 050* 47,650*	20 050* 46,700	20 350* 43,950*	15 350 32,950	16 300* 35,000	11 500 24,750
2900 mm 9'6"	J1865X 6'1"	kg lb	—	—	17 600* 42,450*	17 600* 42,450*	20 150* 43,550*	15 200 32,650	16 200 34,800	11 400 24,500

Stick	Bucket		10.5 m 35'0"		12 m 40'0"		13.5 m 45'0"		At Max. Reach	
			Front	Side	Front	Side	Front	Side	Front	Side
5500 mm 18'1"	H1380T 4'6"	kg lb	13 650 29,300	9850 21,100	10 950 23,450	7800 16,700	8900 19,050	6250 13,350	5200* 11,450*	5100 11,250
4400 mm 14'5"	H1800X 5'10"	kg lb	13 350 28,600	9550 20,500	10 700 22,950	7600 16,200	—	—	8050* 17,750*	5900 12,950
3400 mm 11'2"	J1780X 5'10"	kg lb	12 700 27,250	8950 19,150	10 150 22,350	7050 15,500	—	—	8750 19,300	6000 13,250
2900 mm 9'6"	J1865X 6'1"	kg lb	12 650 27,100	8850 18,950	—	—	—	—	9250 20,350	6350 14,000

375 ● GP Boom ● 610 mm (2'0") Double Grousers

Stick	Bucket		4.5 m 15'0"		6 m 20'0"		7.5 m 25'0"		9 m 30'0"	
			Front	Side	Front	Side	Front	Side	Front	Side
5500 mm 18'1"	H1380T 4'6"	kg lb	13 700* 31,600*	13 700* 31,600*	27 700* 59,800*	24 350 52,300	21 100* 45,500*	17 200 37,050	16 900* 36,600*	12 950 27,800
4400 mm 14'5"	H1800X 5'10"	kg lb	13 100* 30,250*	13 100* 30,250*	27 900* 60,350*	23 500 50,550	21 400* 46,300*	16 650 35,850	17 200* 37,150*	12 550 27,000
3400 mm 11'2"	J1780X 5'10"	kg lb	—	—	26 700* 57,900*	22 450 48,200	20 800* 44,950*	15 800 33,950	16 650* 35,750	11 850 25,450

Stick	Bucket		10.5 m 35'0"		12 m 40'0"		13.5 m 45'0"		At Max. Reach	
			Front	Side	Front	Side	Front	Side	Front	Side
5500 mm 18'1"	H1380T 4'6"	kg lb	13 850 29,750	10 100 21,600	11 100 23,800	8000 17,100	7800* 12,800*	6400 12,800*	4150* 9100*	4150* 9100*
4400 mm 14'5"	H1800X 5'10"	kg lb	13 550 29,150	9800 21,000	10 900 23,350	7750 16,600	—	—	6750* 14,850*	6300 13,900
3400 mm 11'2"	J1780X 5'10"	kg lb	12 950 27,800	9200 19,650	—	—	—	—	7850* 17,250*	6550 14,350

375 ● Mass Boom ● 610 mm (2'0") Double Grousers

Stick	Bucket		4.5 m 15'0"		6 m 20'0"		7.5 m 25'0"		9 m 30'0"		10.5 35'0"		At Max. Reach	
			Front	Side	Front	Side	Front	Side	Front	Side	Front	Side	Front	Side
4100 mm 13'5"	J2040X 6'8"	kg lb	23 650* 54,750*	23 650* 54,750*	27 950* 60,400*	22 650 48,600	21 350* 46,100*	15 700 33,700	16 300 34,950	11 550 24,750	12 500 26,700	8750 18,650	7050* 15,500*	6650 14,700
3400 mm 11'2"	J2210X 7'3"	kg lb	22 450* 52,050*	22 450* 52,050*	27 750* 60,050*	22 350 47,950	21 350* 46,150*	15 550 33,400	16 250 34,800	11 500 24,600	—	—	8900* 19,550*	7500 16,500
2900 mm 9'6"	J2390MX 7'10"	kg lb	20 850* 48,450*	20 850* 48,450*	27 100* 58,650*	21 900* 47,000	20 950* 45,200*	15 250 32,700	15 950 34,250	11 250 24,050	—	—	9400* 20,750*	7850 17,300

*Load limited by hydraulic capacity rather than tipping.

Japan/U.S. Sourced

375 Heavy Lift ● Reach Boom ● 750 mm (2'6") Double Grousers
● 11.6 t (25,600 lb) Counterweight with C/W removal

Stick	Bucket		4.5 m 15'0"		6 m 20'0"		7.5 m 25'0"		9 m 30'0"	
			Front	Side	Front	Side	Front	Side	Front	Side
5500 mm 18'1"	H1380T 4'6"	kg lb	11 300 26,050	11 300 26,050	29 600 64,400	24 500 52,700	22 700 49,100	17 400 37,450	18 050 38,800	13 150 28,250
4400 mm 14'5"	H1800X 5'10"	kg lb	10 400 24,150	10 400 24,150	27 750 64,500	23 700 50,950	23 000 49,700	16 850 36,200	17 650 37,900	12 750 27,350
3400 mm 11'2"	J1780X 5'10"	kg lb	—	—	21 550 51,150	21 550 48,550	22 250 48,150	15 950 34,300	16 900 36,300	12 000 25,800
2900 mm 9'6"	J1865X 6'1"	kg lb	—	—	18 950 45,650	18 950 45,650	22 050 47,750	15 850 34,000	16 800 36,050	11 900 25,600

Stick	Bucket		10.5 m 35'0"		12 m 40'0"		13.5 m 45'0"		At Max. Reach	
			Front	Side	Front	Side	Front	Side	Front	Side
5500 mm 18'1"	H1380T 4'6"	kg lb	14 100 30,300	10 250 22,000	11 350 24,300	8150 17,450	9250 19,850	6550 14,000	5700* 12,600*	5350 11,800
4400 mm 14'5"	H1800X 5'10"	kg lb	13 800 29,650	9950 21,350	11 100 23,800	7950 17,000	—	—	8750* 19,250*	6200 13,600
3400 mm 11'2"	J1780X 5'10"	kg lb	13 200 28,300	9350 20,000	10 550 23,250	7400 16,250	—	—	9150 20,100	6350 13,950
2900 mm 9'6"	J1865X 6'1"	kg lb	13 100 28,150	9250 19,850	—	—	—	—	9650 21,200	6700 14,750

375 Heavy Lift ● GP Boom ● 750 mm (2'6") Double Grousers
● 11.6 t (25,600 lb) Counterweight with C/W removal

Stick	Bucket		4.5 m 15'0"		6 m 20'0"		7.5 m 25'0"		9 m 30'0"	
			Front	Side	Front	Side	Front	Side	Front	Side
5500 mm 18'1"	H1380T 4'6"	kg lb	14 800 34,050	14 800 34,050	30 050 64,950	25 200 54,150	22 950 49,600	17 850 38,400	18 350 39,450	13 450 28,900
4400 mm 14'5"	H1800X 5'10"	kg lb	14 150 32,600	14 150 32,600	30 300 65,600	24 350 52,400	23 350 50,450	17 300 37,200	17 950 38,600	13 050 28,050
3400 mm 11'2"	J1780X 5'10"	kg lb	—	—	29 150 63,150	23 300 50,000	22 700 49,150	16 450 35,350	17 250 37,050	12 350 26,500

Stick	Bucket		10.5 m 35'0"		12 m 40'0"		13.5 m 45'0"		At Max. Reach	
			Front	Side	Front	Side	Front	Side	Front	Side
5500 mm 18'1"	H1380T 4'6"	kg lb	14 350 30,800	10 500 22,500	11 500 24,700	8350 17,850	8500 14,050	6700 14,050	4600* 10,050*	4600* 10,050*
4400 mm 14'5"	H1800X 5'10"	kg lb	14 050 30,200	10 200 21,850	11 300 24,200	8100 17,350	—	—	7350* 16,200*	6600 14,550
3400 mm 11'2"	J1780X 5'10"	kg lb	13 450 28,850	9600 20,550	—	—	—	—	8550* 18,800*	6850 15,050

375 Heavy Lift ● Mass Boom ● 750 mm (2'6") Double Grousers
● 11.6 t (25,600 lb) Counterweight with C/W removal

Stick	Bucket		4.5 m 15'0"		6 m 20'0"		7.5 m 25'0"		9 m 30'0"		10.5 35'0"		At Max. Reach	
			Front	Side	Front	Side	Front	Side	Front	Side	Front	Side	Front	Side
4100 mm 13'5"	J2040X 6'8"	kg lb	25 450 58,800	25 450 58,800	30 350 65,700	24 950 53,550	23 250 50,300	17 400 37,350	17 850 38,250	12 850 27,600	13 750 29,400	9850 21,000	7700* 16,950*	7600 16,700
3400 mm 11'2"	J2210X 7'3"	kg lb	24 150 55,900	24 150 55,900	30 200 65,350	24 600 52,850	23 300 50,350	17 250 37,000	17 750 38,150	12 800 27,500	—	—	9650* 21,300*	8500 18,650
2900 mm 9'6"	J2390MX 7'10"	kg lb	22 400 52,100	22 400 52,100	29 500 63,900	24 200 51,950	22 850 49,400	16 900 36,350	17 500 37,550	12 550 26,900	—	—	10 250* 22,550*	8900 19,550

*Load limited by hydraulic capacity rather than tipping.

Belgium Sourced

375 ● GP Boom ● 610 mm (2'0") Track Shoes

Stick	Bucket		4.5 m 15'0"		6 m 20'0"		7.5 m 25'0"		9 m 30'0"	
			Front	Side	Front	Side	Front	Side	Front	Side
3.4 m 11'2"	3.6 m ³ 4.7 yd ³	kg lb	—	—	26 120* 57,590*	22 200 48,950	20 270* 44,690*	15 600 34,390	16 180* 35,670*	11 660 25,710
4.4 m 14'5"	3.2 m ³ 4.1 yd ³	kg lb	12 880* 28,400*	12 880* 28,400*	27 500* 60,630*	23 510 51,830	21 080* 46,480*	16 640 36,690	16 890* 37,240*	12 510 27,580
5.5 m 18'1"	2.8 m ³ 3.6 yd ³	kg lb	13 390* 29,520*	13 390* 29,520*	27 090* 59,730*	24 130 53,200	20 560* 45,330*	17 010 37,500	16 440* 36,250*	12 730 28,060

Stick	Bucket		10.5 m 35'0"		12 m 40'0"		13.5 m 45'0"		At Max. Reach	
			Front	Side	Front	Side	Front	Side	Front	Side
3.4 m 11'2"	3.6 m ³ 4.7 yd ³	kg lb	12 760 28,130	8970 19,770	—	—	—	—	7520* 16,580*	6240 13,750
4.4 m 14'5"	3.2 m ³ 4.1 yd ³	kg lb	13 510* 29,780*	9720 21,430	10 800 23,800	7680 16,930	—	—	6590* 14,530*	6160 13,580
5.5 m 18'1"	2.8 m ³ 3.6 yd ³	kg lb	13 640* 30,070*	9840 21,690	10 870 23,960	7740 17,060	7630* 16,820*	6150 13,560	3930* 8660*	3930 8660

375 ● Mass Boom ● 610 mm (2'0") Track Shoes

Stick	Bucket		4.5 m 15'0"		6 m 20'0"		7.5 m 25'0"		9 m 30'0"		10.5 m 35'0"		At Max. Reach	
			Front	Side	Front	Side	Front	Side	Front	Side	Front	Side	Front	Side
2.9 m 9'6"	4.4 m ³ 5.75 yd ³	kg lb	20 590* 45,400*	20 590* 45,400*	26 750* 58,980*	23 340 51,460	20 650* 45,530*	16 290 35,910	16 250* 35,830*	12 050 26,570	—	—	9250* 20,390*	8390 18,490
3.4 m 11'2"	4.4 m ³ 5.75 yd ³	kg lb	21 910* 48,310*	21 910* 48,310*	27 100* 59,750*	23 520 51,860	20 770* 45,790*	16 350 36,050	16 390* 36,130*	12 050 26,570	12 720* 28,040*	9130 20,130	8480* 18,690*	7740 17,060
4.1 m 13'5"	3.6 m ³ 4.7 yd ³	kg lb	23 620* 52,080*	23 620* 52,080*	27 600* 60,850*	24 090 53,110	21 060* 46,430*	16 770 36,970	16 740* 36,910*	12 370 27,270	13 230* 29,170*	9410 20,740	6930* 15,280*	6930* 15,280*

Japan/U.S. Sourced

375 ● Reach Boom ● 750 mm (2'6") Double Grousers

Stick	Bucket		4.5 m 15'0"		6 m 20'0"		7.5 m 25'0"		9 m 30'0"	
			Front	Side	Front	Side	Front	Side	Front	Side
5500 mm 18'1"	H1380T 4'6"	kg lb	10 450* 24,100*	10 450* 24,100*	27 400* 59,200*	24 900 53,500	20 850* 45,000*	17 700 38,050	16 700* 36,050*	13 350 28,700
4400 mm 14'5"	H1800X 5'11"	kg lb	9650* 22,350*	9650* 22,350*	25 900* 59,200*	24 100 51,750	21 050* 45,500*	17 150 36,850	16 900* 36,450*	12 950 27,850
3400 mm 11'2"	J1780X 5'10"	kg lb	—	—	20 100* 47,750*	20 100* 47,750*	20 350* 43,950*	16 250 34,950	16 300* 35,200*	12 250 26,300
2900 mm 9'6"	J1865X 6'1"	kg lb	—	—	17 700* 42,650*	17 700* 42,650*	20 150* 43,550*	16 100 34,650	16 200* 35,000*	12 150 26,050

Stick	Bucket		10.5 m 35'0"		12 m 40'0"		13.5 m 45'0"		At Max. Reach	
			Front	Side	Front	Side	Front	Side	Front	Side
5500 mm 18'1"	H1380T 4'6"	kg lb	13 850* 29,900*	10 450 22,400	11 750 25,400	8300 17,800	10 100* 20,650*	6700 14,300	5200* 11,450*	5200* 11,450*
4400 mm 14'5"	H1800X 5'11"	kg lb	13 950* 30,150*	10 150 21,750	11 750* 25,250*	8100 17,300	—	—	8050* 17,750*	6300 13,900
3400 mm 11'2"	J1780X 5'10"	kg lb	13 350* 28,800*	9500 20,400	10 900* 24,000*	7550 16,600	—	—	9200* 20,250*	6500 14,250
2900 mm 9'6"	J1865X 6'1"	kg lb	13 250* 28,500*	9450 20,250	—	—	—	—	9450* 20,750*	6850 15,100

*Load limited by hydraulic capacity rather than tipping.

Japan/U.S. Sourced

375 L ● GP Boom ● 750 mm (2'6") Double Grousers

Stick	Bucket		4.5 m 15'0"		6 m 20'0"		7.5 m 25'0"		9 m 30'0"	
			Front	Side	Front	Side	Front	Side	Front	Side
5500 mm 18'1"	H1380T 4'6"	kg lb	13 700* 31,650*	13 700* 31,650*	27 700* 59,850*	25 550 54,950	21 100* 45,550*	18 150 39,000	16 950* 36,600*	13 650 29,350
4400 mm 14'5"	H1800X 5'10"	kg lb	13 150* 30,350*	13 150* 30,350*	27 900* 60,350*	24 750 53,200	21 400* 46,300*	17 600 37,800	17 200* 37,150*	13 300 28,550
3400 mm 11'2"	J1865X 6'1"	kg lb	—	—	26 600* 57,600*	23 550 50,600	20 650* 44,700*	16 600 35,700	16 550* 35,700*	12 500 26,800
2900 mm 9'6"	J1865X 6'1"	kg lb	—	—	25 850* 56,750*	23 500 50,500	20 650* 44,600*	16 600 35,650	16 550* 35,750*	12 500 26,800

Stick	Bucket		10.5 m 35'0"		12 m 40'0"		13.5 m 45'0"		At Max. Reach	
			Front	Side	Front	Side	Front	Side	Front	Side
5500 mm 18'1"	H1380T 4'6"	kg lb	14 100* 30,500*	10 650 22,900	12 000* 25,950*	8500 18,200	7800* 12,750*	6850 12,750*	4150* 9100*	4150* 9100*
4400 mm 14'5"	H1800X 5'10"	kg lb	14 250* 30,750*	10 400 22,250	11 950* 25,650*	8300 17,700	—	—	6750* 14,900*	6750 14,850
3400 mm 11'2"	J1865X 6'1"	kg lb	13 550* 29,150*	9700 20,750	—	—	—	—	7750* 17,100*	6900 15,200
2900 mm 9'6"	J1865X 6'1"	kg lb	13 450* 28,950*	9700 20,800	—	—	—	—	8250* 18,150*	7400 16,350

375 L Heavy Lift ● GP Boom ● 750 mm (2'6") Double Grousers
● 11.6 t (25,600 lb) Counterweight with C/W removal

Stick	Bucket		4.5 m 15'0"		6 m 20'0"		7.5 m 25'0"		9 m 30'0"	
			Front	Side	Front	Side	Front	Side	Front	Side
5500 mm 18'1"	H1380T 4'6"	kg lb	11 300 26,100	11 300 26,100	29 550 64,400	25 450 54,700	22 700 49,100	18 100 38,900	18 250 39,400	13 700 29,400
4400 mm 14'5"	H1800X 5'10"	kg lb	10 450 24,250	10 450 24,250	27 750 64,500	24 650 52,950	23 000 49,700	17 550 37,700	18 450 39,900	13 300 28,550
3400 mm 11'2"	J1865X 6'1"	kg lb	—	—	21 600 51,300	21 600 50,600	22 250 48,150	16 650 35,800	17 900 38,700	12 550 26,950
2900 mm 9'6"	J1865X 6'1"	kg lb	—	—	19 050 45,650	19 050 45,850	22 050 47,750	16 500 35,500	17 800 38,450	12 450 26,750

Stick	Bucket		10.5 m 35'0"		12 m 40'0"		13.5 m 45'0"		At Max. Reach	
			Front	Side	Front	Side	Front	Side	Front	Side
5500 mm 18'1"	H1380T 4'6"	kg lb	15 200 32,800	10 700 22,950	12 950 28,000	8550 18,300	11 150 22,400	6900 14,750	5700* 12,600*	5650 12,450
4400 mm 14'5"	H1800X 5'10"	kg lb	15 300 33,100	10 400 22,300	12 950 27,850	8300 17,800	—	—	8750* 19,300*	6500 14,300
3400 mm 11'2"	J1865X 6'1"	kg lb	14 750 31,800	9800 20,950	12 100 26,650	7750 17,100	—	—	10 150* 22,300*	6700 14,700
2900 mm 9'6"	J1865X 6'1"	kg lb	14 600 31,500	9700 20,800	—	—	—	—	10 500* 23,150*	7050 15,550

*Load limited by hydraulic capacity rather than tipping.

Excavators

Lifting Capacity At Ground Level

● 375 L

Japan/U.S. Sourced

375 L Heavy Lift ● GP Boom ● 750 mm (2'6") Double Grousers ● 11.6 t (25,600 lb) Counterweight with C/W removal

Stick	Bucket		4.5 m 15'0"		6 m 20'0"		7.5 m 25'0"		9 m 30'0"	
			Front	Side	Front	Side	Front	Side	Front	Side
5500 mm 18'1"	H1380T 4'6"	kg lb	14 800 34,100	14 800 34,100	30 050 65,000	26 100 56,150	22 950 49,600	18 550 39,850	18 500 39,950	14 000 30,050
4400 mm 14'5"	H1800X 5'10"	kg lb	14 200 32,700	14 200 32,700	30 350 65,600	25 300 54,400	23 350 50,450	18 000 38,650	18 800 40,600	13 600 29,200
3400 mm 11'2"	J1865X 6'1"	kg lb	—	—	29 150 63,150	24 200 52,050	22 700 49,150	17 100 36,800	18 250 39,450	12 900 27,700
2900 mm 9'6"	J1865X 6'1"	kg lb	—	—	27 750 61,950	24 050 51,700	22 550 48,800	17 000 36,500	18 150 39,250	12 800 27,500

Stick	Bucket		10.5 m 35'0"		12 m 40'0"		13.5 m 45'0"		At Max. Reach	
			Front	Side	Front	Side	Front	Side	Front	Side
5500 mm 18'1"	H1380T 4'6"	kg lb	15 450 33,400	10 950 23,450	13 200 28,550	8700 18,650	8500 14,000	7050 14,000	4600* 10,100*	4600* 10,100*
4400 mm 14'5"	H1800X 5'10"	kg lb	15 600 33,700	10 650 22,850	13 150 28,250	8500 18,200	—	—	7400* 16,250*	6950 15,250
3400 mm 11'2"	J1865X 6'1"	kg lb	15 000 32,350	10 050 21,500	—	—	—	—	8550* 18,800*	7200 15,850
2900 mm 9'6"	J1865X 6'1"	kg lb	14 850 31,900	9950 21,350	—	—	—	—	8950* 19,750*	7650 16,800

Belgium Sourced

375 L ● GP Boom ● 610 mm (2'0") Track Shoes

Stick	Bucket		4.5 m 15'0"		6 m 20'0"		7.5 m 25'0"		9 m 30'0"	
			Front	Side	Front	Side	Front	Side	Front	Side
3.4 m 11'2"	3.6 m ³ 4.7 yd ³	kg lb	—	—	26 120* 57,590*	23 130 51,000	20 270* 44,690*	16 280 35,890	16 180* 35,670*	12 190 26,870
4.4 m 14'5"	3.2 m ³ 4.1 yd ³	kg lb	12 880* 28,400*	12 880* 28,400*	27 500* 60,630*	24 430 53,860	21 080* 46,480*	17 310 38,160	16 890* 37,240*	13 040 28,750
5.5 m 18'1"	2.8 m ³ 3.6 yd ³	kg lb	13 390* 29,520*	13 390* 29,520*	27 090* 59,730*	25 060 55,250	20 560* 45,330*	17 690 39,000	16 440* 36,250*	13 260 29,230

Stick	Bucket		10.5 m 35'0"		12 m 40'0"		13.5 m 45'0"		At Max. Reach	
			Front	Side	Front	Side	Front	Side	Front	Side
3.4 m 11'2"	3.6 m ³ 4.7 yd ³	kg lb	13 190* 29,080*	9410 20,740	—	—	—	—	7520* 16,580*	6590 14,530
4.4 m 14'5"	3.2 m ³ 4.1 yd ³	kg lb	13 950* 30,750*	10 160 22,400	11 670* 25,730*	8060 17,770	—	—	6590* 14,530*	6480 14,280
5.5 m 18'1"	2.8 m ³ 3.6 yd ³	kg lb	13 640* 30,070*	10 280 22,660	11 570* 25,510*	8120 17,900	7630* 16,820*	6480 14,280	3930* 8660*	3930* 8660*

375 L ● Mass Boom ● 610 mm (2'0") Track Shoes

Stick	Bucket		4.5 m 15'0"		6 m 20'0"		7.5 m 25'0"		9 m 30'0"		10.5 m 35'0"		At Max. Reach	
			Front	Side	Front	Side	Front	Side	Front	Side	Front	Side	Front	Side
2.9 m 9'6"	4.4 m ³ 5.75 yd ³	kg lb	20 590* 45,400*	20 590* 45,400*	26 750* 58,980*	24 260 53,490	20 650* 45,530*	16 960 37,390	16 250* 35,830*	12 580 27,730	—	—	9250* 20,390*	8800 19,400
3.4 m 11'2"	4.4 m ³ 5.75 yd ³	kg lb	21 910* 48,310*	21 900* 48,310*	27 100* 59,750*	24 440 53,890	20 770* 45,790*	17 030 37,550	16 390* 36,130*	12 580 27,730	12 720* 28,040*	9570 21,100	8480* 18,690*	8140 17,940
4.1 m 13'5"	3.6 m ³ 4.7 yd ³	kg lb	23 620* 52,080*	23 620* 52,080*	27 600* 60,850*	25 010 55,140	21 060* 46,430*	17 440 38,450	16 740* 36,910*	12 900 28,440	13 490* 29,740*	9850 21,710	6930* 15,280*	6930* 15,280*

*Load limited by hydraulic capacity rather than tipping.

EXCAVATOR BUCKET CAPACITIES

Caterpillar rates excavator buckets to conform with both PCSA standard No. 3 and SAE standard J-296. Buckets are rated on both their struck and heaped capacities as follows:

Struck Capacity

Volume actually enclosed inside the outline of the sideplates and rear and front bucket enclosures without any consideration for any material supported or carried by the spillplate or bucket teeth.

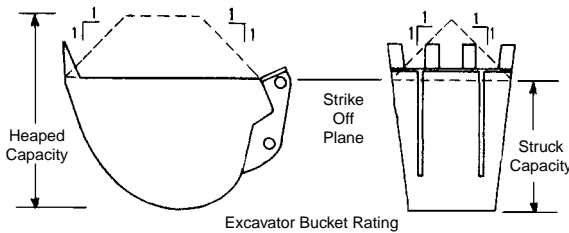

Heaped Capacity

Volume in the bucket under the strike off plane plus the volume of the heaped material above the strike off plane, having an angle of repose of 1:1 without any consideration for any material supported or carried by the spillplate or bucket teeth.

The Committee on European Construction Equipment (CECE) rates heaped bucket pay loads on a 2:1 angle of repose for material above the strike off plane.

CURL AND CROWD FORCES

Bucket penetration into a material is achieved by the bucket curling force (F_B) and stick crowd force (F_S). Rated digging forces are the digging forces that can be exerted at the outermost cutting point. These forces can be calculated by applying working relief hydraulic pressure to the cylinder(s) providing the digging force. The digging forces listed on next page conform with SAE Standard J1179 and PCSA Standard No. 3. The values may not be directly comparable to forces for machines rated by other methods than those described below.

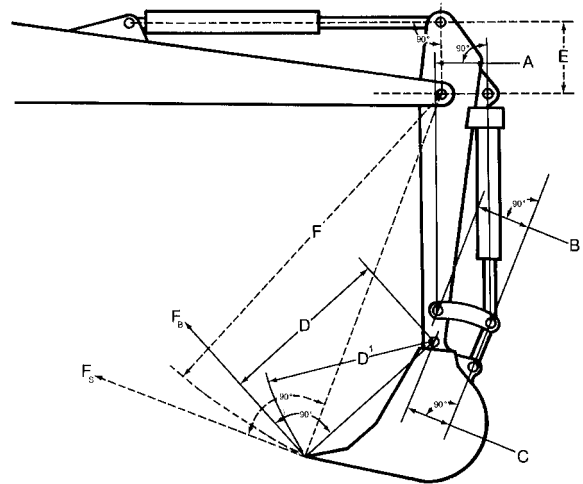

$$F_B = \text{Radial tooth force due to bucket cylinder} \\ = \frac{\text{Bucket cylinder force}}{\text{Arm D length}} \left(\frac{\text{Arm A} \times \text{Arm C}}{\text{Arm B}} \right)$$

$$\text{Cylinder force} = (\text{Pressure}) \times (\text{End area of cylinder head}) \\ \text{Arm D} = \text{Bucket tip radius}$$

Maximum radial tooth force due to bucket cylinder (bucket curling force) is the digging force generated by the bucket cylinder(s) and tangent to the arc of radius D^1 . The bucket shall be positioned to obtain maximum output moment from the bucket cylinder(s) and connecting linkages. When calculating, maximum F_B occurs when the factor — Arm A times Arm C divided by Arm B — becomes the maximum.

$$F_S = \text{Radial tooth force due to stick cylinder} \\ = \frac{(\text{Stick cylinder force}) \times (\text{Arm E length})}{(\text{Arm F length})}$$

$$\text{Arm F} = \text{Bucket tip radius} + \text{stick length}$$

Maximum radial tooth force due to stick cylinder (stick crowd force) is the digging force generated by the stick cylinder(s) and tangent to the arc of radius F. The stick shall be positioned to obtain the maximum output moment from the arm cylinder and the bucket positioned as described in the bucket force rating. When calculating, maximum F_S occurs when the axis in the stick cylinder working direction is at a right angle to the line connecting the stick cylinder pin and the boom nose pin.

Bucket Selection Considering Bucket Curl and Stick Crowd Forces

The combination of the excavator's stick crowd force and bucket curling force give this machine configuration more effective bucket penetration force per mm (inch) of bucket cutting edge than is available with other machine types such as wheel and track loaders.

As a result of high penetration force, an excavator bucket is comparatively easy to load. Also, the higher unit breakout forces allow the excavator's economic application range to be extended farther into the tougher soils (coral, caliche, shale, limestone) before blasting or ripping is required.

To take full advantage of an excavator's high penetration forces, buckets should be selected so they are well matched to soil conditions that are encountered. The two important things to consider are bucket width and bucket tip radius.

As a general rule, wide buckets are used in easily dug soil and narrow buckets in harder material. In hard rocky soils, tip radius also has to be considered in bucket selection. Because the shorter tip radius buckets provide more total bucket curling force than the long tip radius buckets, they are generally the easiest to load. A good rule of thumb when selecting a Caterpillar bucket for hard material is to choose the narrowest bucket that has a short tip radius.

Other factors such as trench bottom width specifications, manbox size, or the desire to conserve bedding material may also influence excavator bucket selection.

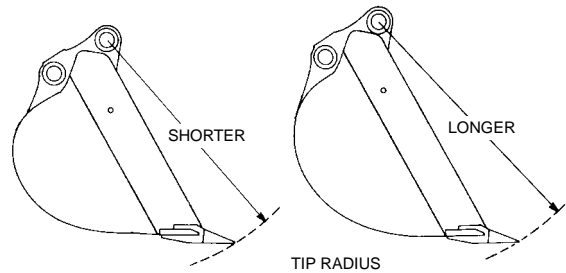

NOTE: See the following pages for listing of Caterpillar buckets by tip radius and cutting edge width.

Model	Source	Bucket Tip Radius		Bucket Curling Forces		Stick Crowd Forces							
		mm	ft	kN	lb	Short		Medium		Long		Extra Long	
301.5	—	500	1'8"	12.6	2840	—	—	8.8	1980	—	—	—	—
307B	Japan	1070	3'6"	44	9890	—	—	35	7870	31	6970	—	—
307B SB	Japan	1070	3'6"	44	9890	—	—	35	7870	31	6970	—	—
307	France	1070	3'6"	49	11,020	—	—	36	7940	32	7050	—	—
311B	Japan	1220	4'0"	80	17,980	62	13,930	58	13,030	50	11,240	—	—
312B	Japan	1220	4'0"	84	18,880	65	14,610	63	14,160	57	12,810	—	—
312B	France	1220	4'0"	94	21,190	73	16,310	64	14,460	58	12,920	—	—
312B L	France	1220	4'0"	84	18,880	71	15,970	63	14,160	57	12,810	—	—
315B	Japan	1340	4'5"	99	22,250	95	21,350	84	18,880	76	17,080	68	15,280
315B L	France	1310	4'4"	*	*	*	*	*	*	*	*	*	*
318B L	France	1410	4'7.5"	*	*	*	*	*	*	*	*	*	*
318B LN	France	1410	4'7.5"	*	*	*	*	*	*	*	*	*	*

*Information unavailable at time of printing.

318B L

Boom		1-Piece Boom			
Stick		Short	Medium	Long	Extra Long
Bucket Tip Radius	mm	1563	1563	1563	1563
	ft	5'1.5"	5'1.5"	5'1.5"	5'1.5"
Bucket Curling Forces	kN	126	125	106	107
	lb	28,310	28,090	23,830	24,050
Stick Crowd Forces	kN	117	101	87	78
	lb	26,290	22,700	19,560	17,530

M312

Boom		1-Piece/VA Boom				
Stick		1600 mm 5'3"	2000 mm 6'6"	2300 mm 7'5"	2600 mm 8'5"	3000 mm 9'9"
Bucket Tip Radius	mm ft	1240/1518 4'1"/5'0"	1100 3'7"	1000 3'3"	1000 3'3"	900 2'11"
Bucket Curling Forces	kN lb	88 22,440	80 20,400	80 20,400	80 20,400	80 20,400
Stick Crowd Forces	kN lb	72 18,360	57 14,535	52 13,260	48 12,240	44 11,220

M315

Boom		1-Piece/VA Boom			
Stick		1700 mm 5'7"	2100 mm 6'11"	2400 mm 7'10"	2600 mm 8'6"
Bucket Tip Radius	mm ft	1220/1290 4'0"/4'3"	1220 4'0"	1220 4'0"	1220 4'0"
Bucket Curling Forces	kN lb	108 24,300	99 22,200	99 22,200	99 22,200
Stick Crowd Forces	kN lb	84 18,900	67 15,000	67 15,000	58 13,000

M318

Boom		1-Piece/VA Boom			
Stick		1800 mm 5'11"	2400 mm 7'10"	2800 mm 9'2"	4000 mm 13'1"
Bucket Tip Radius	mm ft	1340/1420 4'5"/4'8"	1340 4'5"	1340 4'5"	1340 4'5"
Bucket Curling Forces	kN lb	122 27,400	114 25,600	114 25,600	107 24,000
Stick Crowd Forces	kN lb	108 24,300	83 18,600	75 16,800	57 12,800

M320

Boom		1-Piece/VA Boom			
Stick		1900 mm 6'3"	2500 mm 8'2"	2900 mm 9'6"	4200 mm 13'9"
Bucket Tip Radius	mm ft	1423 4'8"	1423 4'8"	1423 4'8"	1423 4'8"
Bucket Curling Forces	kN lb	137 30,800	127 28,500	127 28,500	127 28,500
Stick Crowd Forces	kN lb	130 29,200	99 22,200	90 20,200	69 15,500

**Japan Sourced
320B**

Boom		Reach Boom			
Stick		R1.9C	R2.5B	R2.9B	R3.9B
Bucket Tip Radius	mm	1487	1409	1480	1480
	ft	4'10.5"	4'7"	4'10.2"	4'10.2"
Bucket Curling Forces	kN	159	132	125	125
	lb	35,750	29,700	28,100	28,100
Stick Crowd Forces	kN	144	113	98	83
	lb	32,400	25,400	22,050	18,650
Boom		Mass Boom			
Stick		M1.9C		M2.4C	
Bucket Tip Radius	mm	1487		1487	
	ft	4'10.5"		4'10.5"	
Bucket Curling Forces	kN	159		160	
	lb	35,750		36,000	
Stick Crowd Forces	kN	144		126	
	lb	32,400		28,300	

**Belgium Sourced
320B**

Boom		Reach Boom		
Stick		R1.9C	R2.5B	R2.9B
Bucket Tip Radius	mm	1550	1410	1410
	ft	5'1"	4'7.5"	4'7.5"
Bucket Curling Forces	kN	153	132	132
	lb	34,400	29,700	29,700
Stick Crowd Forces	kN	144	113	99
	lb	32,400	25,400	22,200
Boom		Mass Boom		
Stick		M1.9C		M2.4C
Bucket Tip Radius	mm	1550		1550
	ft	5'1"		5'1"
Bucket Curling Forces	kN	153		154
	lb	34,400		34,600
Stick Crowd Forces	kN	144		125
	lb	32,400		28,100
Boom		VA Boom*		
Stick		M1.9C		M2.4C
Bucket Tip Radius	mm	1550		1550
	ft	5'1"		5'1"
Bucket Curling Forces	kN	153		132
	lb	34,400		29,700
Stick Crowd Forces	kN	144		113
	lb	32,400		25,400

*Preliminary information.

**Japan/U.S. Sourced
322B**

Boom		Reach Boom		
Stick		R2.5S	R2.95S	R3.6B
Bucket Tip Radius	mm ft	1550 5'1"	1550 5'1"	1409 4'7.5"
Bucket Curling Forces	kN lb	151 33,950	151 33,950	131 29,500
Stick Crowd Forces	kN lb	136 30,640	116 26,230	104 23,400
Boom		Mass Boom		
Stick		M2.0D	M2.5D	
Bucket Tip Radius	mm ft	1660 5'5.4"	1660 5'5.4"	
Bucket Curling Forces	kN lb	189 42,550	189 42,550	
Stick Crowd Forces	kN lb	151 33,950	133 29,980	

**Belgium Sourced
322B**

Boom		Reach Boom		
Stick		R2.5S	R2.95S	
Bucket Tip Radius	mm ft	1550 5'1"	1550 5'1"	
Bucket Curling Forces	kN lb	149 33,500	149 33,500	
Stick Crowd Forces	kN lb	141 31,700	121 27,200	
Boom		Mass Boom		
Stick		M2.0D	M2.5D	
Bucket Tip Radius	mm ft	1670 5'5.7"	1670 5'5.7"	
Bucket Curling Forces	kN lb	187 42,000	187 42,000	
Stick Crowd Forces	kN lb	155 34,800	136 30,600	
Boom		VA Boom*		
Stick		M2.0D	M2.5D	
Bucket Tip Radius	mm ft	1670 5'5.7"	1670 5'5.7"	
Bucket Curling Forces	kN lb	187 42,000	187 42,000	
Stick Crowd Forces	kN lb	155 34,800	136 30,600	

*Preliminary information.

**Japan/U.S. Sourced
325B**

Boom		Reach Boom		
Stick		R2.0D	R2.7C	R3.2C
Bucket Tip Radius	mm ft	1660 5'5.4"	1487 4'10.5"	1487 5'1"
Bucket Curling Forces	kN lb	189 42,470	160 35,960	160 35,960
Stick Crowd Forces	kN lb	161 36,180	136 30,560	118 26,520
Boom		Mass Boom		
Stick		M2.0D		M2.5D
Bucket Tip Radius	mm ft	1660 5'5.4"		1660 5'5.4"
Bucket Curling Forces	kN lb	198 44,490		189 42,470
Stick Crowd Forces	kN lb	162 36,400		140 31,460

**Belgium Sourced
325B**

Boom		Reach Boom		
Stick		R2.0C	R2.65C	R3.2C
Bucket Tip Radius	mm ft	1670 5'5.7"	1550 5'1"	1550 5'1"
Bucket Curling Forces	kN lb	188 42,300	152 34,200	151 33,900
Stick Crowd Forces	kN lb	166 37,300	137 30,800	120 27,000
Boom		Mass Boom		
Stick		M2.0D		M2.5D
Bucket Tip Radius	mm ft	1670 5'5.7"		1670 5'5.7"
Bucket Curling Forces	kN lb	188 42,300		188 42,300
Stick Crowd Forces	kN lb	165 37,100		144 32,400
Boom		VA Boom*		
Stick		M2.0D		M2.5D
Bucket Tip Radius	mm ft	1670 5'5.7"		1670 5'5.7"
Bucket Curling Forces	kN lb	188 42,300		188 42,300
Stick Crowd Forces	kN lb	165 37,100		144 32,400

*Preliminary information.

**Japan/U.S. Sourced
330B**

Boom		Reach Boom			
Stick		R2.2E	R2.8D	R3.3D	R3.9D
Bucket Tip Radius	mm	1845	1600	1600	1600
	ft	6'0.1"	5'3"	5'3"	5'3"
Bucket Curling Forces	kN	227	189	189	190
	lb	51,000	42,470	42,470	42,670
Stick Crowd Forces	kN	209	175	151	134
	lb	46,970	39,330	33,930	30,110
Boom		Mass Boom			
Stick		M2.2E			M2.6E
Bucket Tip Radius	mm	1845			1845
	ft	6'0.1"			6'0.1"
Bucket Curling Forces	kN	227			227
	lb	51,000			51,000
Stick Crowd Forces	kN	239			173
	lb	53,700			38,880

**Belgium Sourced
330B**

Boom		Reach Boom			
Stick		R2.2E	R2.8D	R3.3D	R3.9D
Bucket Tip Radius	mm	1730	1660	1660	1660
	ft	5'8.1"	5'5.3"	5'5.3"	5'5.3"
Bucket Curling Forces	kN	232	187	187	187
	lb	52,200	42,000	42,000	42,000
Stick Crowd Forces	kN	216	179	155	138
	lb	48,600	40,200	34,800	42,300
Boom		Mass Boom			
Stick		M2.15E			M2.6E
Bucket Tip Radius	mm	1780			1780
	ft	5'8.1"			5'8.1"
Bucket Curling Forces	kN	232			232
	lb	52,200			52,200
Stick Crowd Forces	kN	216			179
	lb	48,600			40,200

345B

Boom		Reach Boom		
Stick		R2.9F	R3.35T	R3.9F
Bucket Tip Radius	mm ft	1870 6'1.6"	1820 5'11.7"	1925 6'3.8"
Bucket Curling Forces	kN lb	231 51,900	229 51,460	225 50,560
Stick Crowd Forces	kN lb	209 46,970	194 43,600	175 39,330
Boom		Mass Boom		
Stick		M2.5G		M3.0V
Bucket Tip Radius	mm ft	1958 6'5.1"		1860 6'1.2"
Bucket Curling Forces	kN lb	252 56,630		260 58,430
Stick Crowd Forces	kN lb	230 51,690		208 46,740

350

Boom		Reach Boom		
Stick		R3.1F	R3.6F	R4.8F
Bucket Tip Radius	mm ft	1870 6'1.6"	1925 6'3.8"	1925 6'3.8"
Bucket Curling Forces	kN lb	219 49,300	213 47,900	213 47,900
Stick Crowd Forces	kN lb	195 43,900	169 38,000	142 32,000
Boom		Mass Boom		
Stick		M2.4G	M3.0G	M3.7F
Bucket Tip Radius	mm ft	1958 6'5.1"	1958 6'5.1"	1870 6'1.6"
Bucket Curling Forces	kN lb	271 61,000	259 58,300	220 49,500
Stick Crowd Forces	kN lb	225 50,600	193 43,400	164 37,000

**Japan/U.S. Sourced
375**

Boom		Reach Boom*			
Stick		R2.9J	R3.4J	R4.4H	R5.5H
Bucket Tip Radius	mm ft	2235 7'4"	2235 7'4"	2100 6'10.7"	2210 7'3"
Bucket Curling Forces	kN lb	421 94,500	422 94,800	335 75,400	317 71,400
Stick Crowd Forces	kN lb	325 73,100	301 67,600	259 58,200	212 47,600
Boom		General Purpose Boom			
Stick		R2.9J*	R3.4J	R4.4H	R5.5H
Bucket Tip Radius	mm ft	2235 7'4"	2235 7'4"	2100 6'10.7"	2210 7'3"
Bucket Curling Forces	kN lb	421 94,500	422 94,800	335 75,400	317 71,400
Stick Crowd Forces	kN lb	325 73,100	301 67,600	259 58,200	212 47,600
Boom		Mass Boom			
Stick		M2.9J	M3.4J	M4.1J	
Bucket Tip Radius	mm ft	2235 7'4"	2235 7'4"	2235 7'4"	
Bucket Curling Forces	kN lb	435 97,600	422 94,800	423 95,000	
Stick Crowd Forces	kN lb	326 73,100	301 67,600	266 59,700	

*Not available in all sales areas.

**Belgium Sourced
375**

Boom		GP Boom			Mass Boom		
Stick		R3.4J	R4.4H	R5.5H	M2.9J	M3.4J	M4.1J
Bucket Tip Radius	mm	2236	2100	2100	2236	2236	2236
	ft	7'4"	6'10.7"	6'10.7"	7'4"	7'4"	7'4"
Bucket Curling Forces	kN	371	309	297	383	384	372
	lb	83,500	69,500	66,800	86,100	86,300	83,600
Stick Crowd Forces	kN	291	251	209	313	291	258
	lb	65,400	56,400	47,100	70,400	65,500	58,100

4

**U.S. Sourced
5130B**

Boom		8 m 26'3"		11 m 36'1"	
Stick*		3.8 m 12'6"	5.2 m 17'1"	3.8 m 12'6"	5.2 m 17'1"
Bucket Tip Radius	mm	3038		3038	
	ft	10'0"		10'0"	
Bucket Curling Force	kN	672		666	
	lb	151,000		150,000	
Rated Arm Force	kN	624		542	
	lb	140,000		122,000	

*11 m (36'1") and 5.2 m (17'1") or 6.6 m (21'8") sticks use smaller bucket linkage.

5230

Boom		9.5 m 31'2"
Stick		4.5 m 14'9"
Bucket Tip Radius	mm	3254
	ft	10'8"
Bucket Curling Force	kN	873
	lb	196,200
Rated Arm Force	kN	874
	lb	196,400

Caterpillar offers a very comprehensive list of high strength steel buckets. High strength steel allows thinner components which helps keep the weight down, maintains durability and improves loadability. The wrong bucket can reduce production 30-40% or more. Caterpillar's in-depth knowledge of machine design, bucket design and application

experience allows offering **machine matched** packages that optimize performance.

Additional buckets may be available and the listed buckets may not be available in all sales areas. Contact your Caterpillar Dealer for your specific bucket needs.

Model	Bucket Type	Teeth	Bucket Bite Width		Bucket Tip Radius		Heaped Capacity		Bucket Weight With Teeth		
			mm	in	mm	in	L	yd ³	kg	lb	
301.5	Digging	0	230	9.1"	440	17.3"	18.3	0.024	25	55	
		3	230	9.1"	500	19.7"	18.3	0.024	29	64	
		0	300	11.8"	440	17.3"	22.2	0.029	27	60	
		3	300	11.8"	500	19.7"	22.2	0.029	31	68	
		0	400	15.7"	440	17.3"	32.9	0.043	32	70	
		3	400	15.7"	500	19.7"	32.9	0.043	35	77	
		0	500	19.7"	440	17.3"	45.1	0.059	36	79	
		4	500	19.7"	500	19.7"	45.1	0.059	41	90	
		0	600	23.6"	440	17.3"	55.8	0.073	41	90	
		4	600	23.6"	500	19.7"	55.8	0.073	45	99	
	Ditch Cleaning	0	800	31.5"	353	13.9"	44.3	0.058	40	88	
		0	1000	39.4"	353	13.9"	55.8	0.073	42	93	
307B, 307B SB, 307	General Purpose		500	20.0"	1070	42.0"	180	0.24	180	397	
			600	24.0"	1070	42.0"	230	0.30	195	430	
			610	*24.0"	1070	42.0"	230	0.30	200	440	
			700	28.0"	1070	42.0"	240	0.31	215	474	
			760	*30.0"	1070	42.0"	310	0.40	230	510	
			800	31.0"	1070	42.0"	280	0.37	225	496	
			915	*36.0"	1070	42.0"	370	0.45	250	550	
		Excavation		300	12.0"	1070	42.0"	90	0.12	122	270
				450	18.0"	1070	42.0"	160	0.21	168	370
				600	24.0"	1070	42.0"	230	0.30	191	420
	750		30.0"	1070	42.0"	300	0.39	208	460		
	800		31.0"	1070	42.0"	325	0.42	215	470		
	850		33.0"	1070	42.0"	350	0.46	222	490		
Extreme Service Excavation		1000	39.0"	1070	42.0"	800	1.05	635	1400		
		300	12.0"	1070	42.0"	90	0.12	133	290		
		450	18.0"	1070	42.0"	160	0.21	174	380		
		600	24.0"	1070	42.0"	230	0.30	197	430		
		750	30.0"	1070	42.0"	300	0.39	214	470		
311B	General Purpose		800	31.0"	1070	42.0"	325	0.42	228	500	
			625	24.0"	1220	48.0"	350	0.46	336	740	
			775	30.0"	1220	48.0"	460	0.60	372	820	
			925	36.0"	1220	48.0"	570	0.75	415	914	
			1075	42.0"	1220	48.0"	670	0.88	459	1011	
	1225	48.0"	1220	48.0"	780	1.02	495	1091			

*Not available for 307.

Model	Bucket Type	Bucket Bite Width		Bucket Tip Radius		Heaped Capacity		Bucket Weight With Teeth	
		mm	in	mm	in	L	yd ³	kg	lb
312B	General Purpose	450	18.0"	1220	48.0"	235	0.31	250	550
		600	24.0"	1220	48.0"	330	0.43	270	594
		625	24.0"	1220	48.0"	350	0.46	336	740
		700	28.0"	1220	48.0"	400	0.52	295	649
		775	30.0"	1220	48.0"	460	0.60	372	820
		900	35.0"	1220	48.0"	540	0.71	340	748
		925	36.0"	1220	48.0"	570	0.75	415	914
		1000	39.0"	1220	48.0"	610	0.79	358	787
		1075	42.0"	1220	48.0"	670	0.88	459	1011
		1100	43.0"	1220	48.0"	680	0.89	385	847
		1200	47.0"	1220	48.0"	750	0.98	403	886
		1225	48.0"	1220	48.0"	780	1.02	495	1091
	Heavy Duty	450	17.7"	1220	48.0"	235	0.31	270	594
		600	23.6"	1220	48.0"	330	0.43	300	660
		700	27.6"	1220	48.0"	400	0.52	322	708
		750	29.5"	1220	48.0"	400	0.52	338	743
		900	35.4"	1220	48.0"	540	0.71	374	822
		1000	39.4"	1220	48.0"	610	0.79	400	880
	Excavation	450	18.0"	1220	48.0"	235	0.31	236	520
		600	24.0"	1220	48.0"	330	0.43	263	580
		700	28.0"	1220	48.0"	400	0.52	286	630
		750	30.0"	1220	48.0"	440	0.58	321	710
		900	35.0"	1220	48.0"	540	0.70	329	725
		1000	39.0"	1220	48.0"	550	0.72	332	730
		1000	39.0"	1220	48.0"	610	0.80	348	770
		1100	43.0"	1220	48.0"	680	0.89	371	820
	Extreme Service Excavation	450	18.0"	1220	48.0"	235	0.31	236	520
		600	24.0"	1220	48.0"	330	0.43	263	580
		700	28.0"	1220	48.0"	400	0.52	287	630
		750	30.0"	1220	48.0"	440	0.58	330	730
		900	35.0"	1220	48.0"	540	0.70	329	725
		1000	39.0"	1220	48.0"	610	0.80	348	770
		1100	43.0"	1220	48.0"	680	0.89	400	880
	Ditch Cleaning	1500	59.0"	N/S		400	0.52	340	750
		1600	63.0"	N/S		330	0.43	350	770
		1800	71.0"	N/S		370	0.48	380	840
		2000	79.0"	N/S		330	0.43	350	770
	Utility	1200	47.0"	N/S		395	0.52	400	880
		1400	55.0"	N/S		465	0.61	440	970
		1600	63.0"	N/S		530	0.69	480	1060
		1800	71.0"	N/S		605	0.79	530	1170
	Utility Light	1200	47.0"	N/S		395	0.52	300	660
		1400	55.0"	N/S		465	0.61	330	730
		1600	63.0"	N/S		530	0.69	360	790
		1800	71.0"	N/S		605	0.79	400	880

N/S = Not Significant for Utility, Utility Light and Ditch Cleaning Bucket.

Model	Bucket Type	Bucket Bite Width		Bucket Tip Radius		Heaped Capacity		Bucket Weight With Teeth	
		mm	in	mm	in	L	yd ³	kg	lb
315B/315B L	General Purpose	610	24.0"	1340	53.0"	380	0.50	419	924
		760	30.0"	1340	53.0"	500	0.65	471	1038
		914	36.0"	1340	53.0"	610	0.80	517	1140
		1067	42.0"	1340	53.0"	690	0.90	566	1248
		1219	48.0"	1340	53.0"	840	1.10	609	1343
	Excavation	600	24.0"	1310	52.0"	350	0.46	365	800
		600	24.0"	1310	52.0"	350	0.46	390	860
		750	30.0"	1310	52.0"	470	0.61	417	920
		750	30.0"	1310	52.0"	470	0.61	435	960
		850	33.0"	1310	52.0"	560	0.73	455	1000
		850	33.0"	1310	52.0"	560	0.73	495	1090
		1000	39.0"	1310	52.0"	680	0.89	502	1100
		1000	39.0"	1310	52.0"	680	0.89	544	1200
		1100	43.0"	1310	52.0"	770	1.01	540	1190
		1100	43.0"	1310	52.0"	770	1.01	542	1195
		1200	47.0"	1310	52.0"	860	1.12	570	1260
		1200	47.0"	1310	52.0"	860	1.12	590	1300
		1300	51.0"	1310	52.0"	930	1.22	609	1340
		1300	51.0"	1310	52.0"	930	1.22	620	1370
		1300	51.0"	1310	52.0"	1000	1.31	647	1430
	1300	51.0"	1310	52.0"	1000	1.31	695	1530	
	Extreme Service Excavation	600	24.0"	1310	52.0"	350	0.46	373	820
		600	24.0"	1310	52.0"	350	0.46	400	880
		750	30.0"	1310	52.0"	470	0.61	425	940
		750	30.0"	1310	52.0"	470	0.61	445	980
		850	33.0"	1310	52.0"	560	0.73	464	1020
		850	33.0"	1310	52.0"	560	0.73	495	1090
		1000	39.0"	1310	52.0"	680	0.89	510	1120
		1000	39.0"	1310	52.0"	680	0.89	555	1220
		1100	43.0"	1310	52.0"	770	1.01	548	1210
		1200	47.0"	1310	52.0"	860	1.12	579	1280
	1200	47.0"	1310	52.0"	860	1.12	630	1390	
	Ditch Cleaning	1600	63.0"	1310	52.0"	330	0.43	360	790
		1800	71.0"		N/S	370	0.48	380	840
		1800	71.0"	1310	52.0"	370	0.48	390	860
		2000	79.0"		N/S	410	0.54	410	910
		2000	79.0"	1310	52.0"	410	0.54	450	990
	Utility	1200	47.0"		N/S	395	0.52	410	900
		1400	55.0"		N/S	465	0.61	450	990
		1600	63.0"		N/S	535	0.70	490	1080
		1800	71.0"		N/S	605	0.79	540	1190
	Trapezoidal	500	20.0"		Slope:1/1.0	380	0.50	345	760
		500	20.0"		Slope:1/1.5	510	0.67	405	890
		2400	94.5"	1310	52.0"	380	0.50	360	790
		3350	131.0"	1310	52.0"	510	0.67	420	930
	Weed Cutting	4000	157.0"	—	—	—	—	—	—

N/S = Not Significant for Utility, Utility Light and Ditch Cleaning Bucket.

Model	Bucket Type	Bucket Family	Bucket Bite Width		Bucket Tip Radius		Heaped Capacity		Bucket Weight With Teeth		
			mm	in	mm	in	L	yd ³	kg	lb	
318B L, 318B LN	Heavy Duty	B	625	24.0"	1563	61.5"	450	0.59	600	1320	
		B	775	30.0"	1563	61.5"	560	0.73	685	1510	
		B	932	36.0"	1563	61.5"	800	1.05	785	1730	
		B	1082	42.0"	1563	61.5"	1000	1.31	850	1870	
		B	1230	48.0"	1551	61.0"	1200	1.57	955	2100	
	Excavation and Excavation Quick Coupling			600	24.0"	1410	55.5"	410	0.54	473	1043
				750	30.0"	1410	55.5"	550	0.72	525	1158
				1000	39.0"	1410	55.5"	800	1.05	654	1442
				1250	49.0"	1410	55.5"	1050	1.37	753	1660
				1400	55.0"	1410	55.5"	1200	1.57	833	1837
	Extreme Excavation and Extreme Excavation Quick Coupling			600	24.0"	1410	55.5"	410	0.54	519	1144
				750	30.0"	1410	55.5"	550	0.72	562	1239
				1000	39.0"	1410	55.5"	800	1.05	702	1548
				1250	49.0"	1410	55.5"	1050	1.37	819	1806
	Utility and Utility Light			1400	55.0"	1410	55.5"	605	0.79	620	1367
				1600	63.0"	1410	55.5"	700	0.92	680	1499
				1800	71.0"	1410	55.5"	790	1.03	740	1632
				2000	79.0"	1410	55.5"	880	1.15	800	1764
	Ditch Cleaning			1800	71.0"	1410	55.5"	490	0.64	545	1202
				2000	79.0"	1410	55.5"	550	0.72	585	1290
Rock and Rock Quick Coupling			600	24.0"	1410	55.5"	410	0.54	547	1206	
			750	30.0"	1410	55.5"	550	0.72	645	1422	
			1000	39.0"	1410	55.5"	810	1.06	751	1656	
			1250	49.0"	1410	55.5"	1050	1.37	875	1929	

Model	Bucket Type	Bucket Family	Bucket Bite Width		Bucket Tip Radius		Heaped Capacity		Bucket Weight With Teeth	
			mm	in	mm	in	L	yd ³	kg	lb
M312/ M315	Excavation		450	17.7"	1240	48.8"	240	0.31	271	600
			600	23.6"	1240	48.8"	330	0.43	304	800
			700	27.6"	1240	48.8"	400	0.52	340	750
			750	29.5"	1318	51.9"	470	0.61	430	950
			850	33.5"	1318	51.9"	560	0.73	473	1040
			900	35.4"	1240	48.8"	540	0.71	366	810
			1000	39.4"	1318	51.9"	610	0.80	410	900
			1100	43.3"	1240	48.8"	680	0.89	438	970
	1200	47.2"	1318	51.9"	860	1.12	458	1010		
	Extreme Service Excavation		1100	43.3"	1240	48.8"	680	0.89	472	1040
1200			47.2"	1240	48.8"	750	0.98	493	1090	
M318	Excavation		600	23.6"	1419	55.9"	400	0.52	540	1190
			750	29.5"	1419	55.9"	550	0.72	560	1235
			1000	39.4"	1340	52.7"	700	0.92	600	1320
			1000	39.4"	1419	55.9"	800	1.05	650	1430
			1100	43.3"	1340	52.7"	800	1.05	640	1410
			1200	47.2"	1340	52.7"	900	1.18	660	1455
	Extreme Service Excavation		1200	47.2"	1340	52.7"	900	1.18	710	1570
			1250	49.2"	1419	55.9"	1050	1.37	740	1630
	Excavation	B	600	24.0"	1410	55.5"	410	0.54	524	1155
			750	30.0"	1410	55.5"	550	0.72	550	1210
			1000	39.0"	1410	55.5"	800	1.05	635	1400
			1250	49.0"	1410	55.5"	1050	1.37	716	1580
			1400	55.0"	1410	55.5"	1200	1.57	752	1660
			1500	59.0"	1410	55.5"	1350	1.77	770	1700
	Extreme Service Excavation	B	600	24.0"	1410	55.5"	410	0.54	552	1220
			750	30.0"	1410	55.5"	550	0.72	606	1340
			1000	39.0"	1410	55.5"	800	1.05	697	1540
			1250	49.0"	1410	55.5"	1050	1.37	772	1700
			1400	55.0"	1410	55.5"	1200	1.57	818	1800
	Rock	B	600	24.0"	1410	55.5"	410	0.54	565	1245
			750	30.0"	1410	55.5"	550	0.72	625	1380
			1000	39.0"	1410	55.5"	800	1.05	775	1710
			1250	49.0"	1410	55.5"	1050	1.37	898	1980
	Ditch Cleaning	B	1800	71.0"	1250	49.2"	480	0.63	477	1050
2000			79.0"	1400	55.1"	580	0.76	680	1500	
2200			87.0"	1250	49.2"	620	0.81	563	1240	
Utility	B	1400	55.0"	N/S		605	0.79	620	1370	
		1600	63.0"	N/S		700	0.92	680	1500	
		1800	71.0"	N/S		790	1.03	740	1630	
		2000	79.0"	N/S		880	1.15	800	1760	
Utility Light	B	1400	55.0"	N/S		605	0.79	470	1040	
		1600	63.0"	N/S		700	0.92	510	1125	
		1800	71.0"	N/S		790	1.03	550	1210	
		2000	79.0"	N/S		880	1.15	600	1320	

N/S = Not Significant for Utility, Utility Light and Ditch Cleaning Bucket.

Model	Bucket Type	Bucket Family	Bucket Bite Width		Bucket Tip Radius		Heaped Capacity		Bucket Weight With Teeth		
			mm	in	mm	in	L	yd ³	kg	lb	
M320	General Purpose		600	23.6"	1423	56.0"	410	0.54	540	1190	
			750	29.5"	1423	56.0"	550	0.72	560	1230	
			1000	39.4"	1423	56.0"	810	1.06	600	1320	
			1100	43.3"	1423	56.0"	900	1.18	685	1510	
			1250	49.2"	1423	56.0"	1050	1.37	740	1630	
			1400	55.1"	1423	56.0"	1200	1.57	780	1920	
			1500	59.0"	1423	56.0"	1350	1.77	810	1790	
	Extreme Service		1200	47.2"	1340	52.8"	900	1.18	710	1565	
			1250	49.2"	1423	56.0"	1050	1.37	750	1650	
	Ditch Cleaning		1800	70.9"	1244	49.0"	480	0.63	477	1050	
			2000	78.7"	1300	51.2"	580	0.76	680	1500	
			2000	78.7"	1400	55.1"	700	0.92	720	1590	
			2300	90.6"	1244	49.0"	620	0.81	570	1260	
			2000	78.7"	896	35.3"	700	0.92	640	1410	
	320B	General Purpose	B	775	30.0"	1626	64.0"	700	0.88	665	1466
B			932	36.0"	1626	64.0"	900	1.12	741	1634	
B			1082	42.0"	1626	64.0"	1100	1.50	777	1713	
B			1230	48.0"	1626	64.0"	1300	1.75	906	1998	
C			775	30.0"	1778	70.0"	800	1.12	807	1779	
C			948	36.0"	1778	70.0"	1100	1.50	909	2004	
C			1098	42.0"	1778	70.0"	1300	1.75	966	2130	
C			1248	48.0"	1778	70.0"	1600	2.12	1052	2320	
C		1395	54.0"	1778	70.0"	1900	2.50	1138	2509		
Excavation			B	1130	44.0"	1480	58.2"	800	1.05	640	1410
			B	1260	50.0"	1409	55.4"	900	1.18	760	1680
			B	1370	54.0"	1409	55.4"	1000	1.31	795	1750
			B	600	23.6"	1410	55.5"	410	0.54	524	1155
			B	750	29.5"	1410	55.5"	550	0.72	550	1210
			B	1000	39.4"	1410	55.5"	800	1.05	635	1400
			B	1250	49.2"	1410	55.5"	1050	1.37	716	1580
			B	1400	55.1"	1410	55.5"	1200	1.57	752	1660
			B	1500	59.1"	1410	55.5"	1350	1.77	770	1700
			C	1370	54.0"	1487	58.5"	1100	1.44	940	2070
			C	1470	58.0"	1487	58.5"	1200	1.57	895	1970
	C		750	29.5"	1550	61.0"	630	0.82	694	1530	
C	1000	39.4"	1550	61.0"	950	1.24	780	1720			
C	1150	45.3"	1550	61.0"	1150	1.50	874	1930			
C	1250	49.2"	1550	61.0"	1250	1.63	903	1990			
C	1350	53.1"	1550	61.0"	1400	1.83	940	2070			
C	1450	57.1"	1550	61.0"	1500	1.96	990	2180			
C	1600	63.0"	1550	61.0"	1700	2.22	1045	2300			

Model	Bucket Type	Bucket Family	Bucket Bite Width		Bucket Tip Radius		Heaped Capacity		Bucket Weight With Teeth	
			mm	in	mm	in	L	yd ³	kg	lb
320B (cont'd)	Extreme Service Excavation	B	600	23.6"	1410	55.5"	410	0.54	552	1220
		B	750	29.5"	1410	55.5"	550	0.72	606	1340
		B	1000	39.4"	1410	55.5"	800	1.05	697	1540
		B	1100	43.0"	1409	55.4"	800	1.05	760	1670
		B	1250	49.2"	1410	55.5"	1050	1.37	772	1700
		B	1400	55.1"	1410	55.5"	1200	1.57	818	1800
		C	750	29.5"	1550	61.0"	630	0.82	722	1590
		C	1000	39.4"	1550	61.0"	950	1.24	863	1900
		C	1150	45.3"	1550	61.0"	1150	1.50	940	2070
		C	1250	49.2"	1550	61.0"	1250	1.63	980	2160
		C	1350	53.1"	1550	61.0"	1400	1.83	1025	2260
		C	1450	57.1"	1550	61.0"	1500	1.96	1085	2390
		C	1600	63.0"	1550	61.0"	1700	2.22	1154	2545
		Heavy Duty	B	625	24.0"	1563	61.5"	450	0.59	600
	B		775	30.0"	1563	61.5"	560	0.73	685	1510
	B		932	36.0"	1563	61.5"	800	1.05	785	1730
	B		1082	42.0"	1563	61.5"	1000	1.31	850	1870
	B		1230	48.0"	1551	61.0"	1200	1.57	955	2100
	B		1377	54.0"	1551	61.0"	1400	1.83	1020	2250
	B		1507	60.0"	1551	61.0"	1500	1.96	1075	2370
	B		1725	68.0"	1203	47.3"	1200	1.60	715*	1580
	C		775	30.0"	1638	64.5"	700	0.88	792	1720
	C		948	36.0"	1638	64.4"	900	1.18	950	2100
	C		1098	42.0"	1638	64.4"	1100	1.44	1060	2340
	C		1248	48.0"	1638	64.4"	1300	1.70	1140	2510
	C		1378	54.0"	1518	60.0"	1200	1.50	1088	2400
	C		1395	54.0"	1638	64.4"	1500	1.96	1240	2730
	C	1522	60.0"	1638	64.5"	1700	2.25	1119	2620	
	C	1680	66.0"	1638	64.5"	1900	2.50	1195	2825	
	Mass Excavation	C	1440	57.0"	1487	58.5"	1300	1.70	940	2060
	Rock	B	600	23.6"	1410	55.5"	410	0.54	565	1245
		B	750	29.5"	1410	55.5"	550	0.72	625	1380
		B	1000	39.4"	1410	55.5"	800	1.05	775	1710
		B	1250	49.2"	1410	55.5"	1050	1.37	898	1980
		C	750	29.5"	1550	61.0"	630	0.82	764	1685
		C	1000	39.4"	1550	61.0"	950	1.24	552	1220
		C	1350	53.1"	1550	61.0"	1400	1.83	1076	2370
	Heavy Duty Rock	B	775	30.0"	1563	61.5"	600	0.75	759	1670
		B	932	36.0"	1563	61.5"	800	1.00	863	1900
		B	1082	42.0"	1563	61.5"	1000	1.25	949	2095
		C	948	36.0"	1638	64.5"	900	1.25	988	2180
		C	1098	42.0"	1638	64.5"	1100	1.50	1084	2390
C	1248	48.0"	1638	64.5"	1300	1.75	1165	2570		
Rock Ripping	C	850	33.0"	1660	65.0"	600	0.75	1084	2385	

*Weight without teeth.

Model	Bucket Type	Bucket Family	Bucket Bite Width		Bucket Tip Radius		Heaped Capacity		Bucket Weight With Teeth		
			mm	in	mm	in	L	yd ³	kg	lb	
320B (cont'd)	Ditch Cleaning	B	1800	70.9"	N/S		490	0.64	545	1200	
		B	2000	78.7"	N/S		550	0.72	585	1290	
		B	2200	86.6"	N/S		610	0.80	625	1380	
		C	2000	78.7"	N/S		730	0.95	820	1810	
		C	2200	86.6"	N/S		805	1.05	880	1940	
		C	2400	94.5"	N/S		880	1.15	980	2160	
		B	1422	60.0"	1143	45.0"	900	1.12	681	1500	
		B	1727	72.0"	1143	45.0"	1100	1.50	786	1733	
		C	1676	66.0"	1130	44.5"	1100	1.50	739	1629	
		C	1829	72.0"	1130	44.5"	1200	1.62	857	1890	
		Utility	B	1400	55.1"	N/S		605	0.79	620	1370
			B	1600	63.0"	N/S		700	0.92	680	1500
	B		1800	70.9"	N/S		790	1.03	740	1630	
	B		2000	78.7"	N/S		880	1.15	800	1760	
	C		1600	63.0"	N/S		940	1.23	970	2140	
	C		1800	70.9"	N/S		1065	1.39	1060	2340	
	C		2000	78.7"	N/S		1190	1.56	1140	2510	
	Utility Light	C	2200	86.6"	N/S		1315	1.72	1220	2690	
		B	1400	55.1"	N/S		605	0.79	470	1040	
		B	1600	63.0"	N/S		700	0.92	510	1125	
		B	1800	70.9"	N/S		790	1.03	550	1210	
		B	2000	78.7"	N/S		880	1.15	600	1320	
		C	1600	63.0"	N/S		940	1.23	730	1610	
		C	1800	70.9"	N/S		1065	1.39	800	1760	
	322B	General Purpose	C	2000	78.7"	N/S		1190	1.56	860	1900
			C	2200	86.6"	N/S		1315	1.72	920	2030
			B	775	30.0"	1626	64.0"	700	0.88	665	1466
			B	932	36.0"	1626	64.0"	900	1.12	741	1634
B			1082	42.0"	1626	64.0"	1100	1.50	777	1713	
B			1230	48.0"	1626	64.0"	1300	1.75	906	1998	
S			625	24.0"	1778	70.0"	600	0.75	691	1524	
S			775	30.0"	1778	70.0"	800	1.12	807	1779	
S			948	36.0"	1778	70.0"	1100	1.50	909	2004	
S			1098	42.0"	1778	70.0"	1300	1.75	966	2130	
S			1248	48.0"	1778	70.0"	1600	2.12	1052	2320	
S			1395	54.0"	1778	70.0"	1900	2.50	1138	2509	
D			775	30.0"	1854	73.0"	800	1.12	953	2101	
D			925	36.0"	1854	73.0"	1100	1.50	1043	2300	
D			1098	42.0"	1854	73.0"	1400	1.88	1122	2474	
D	1246	48.0"	1854	73.0"	1700	2.25	1202	2650			
D	1400	55.0"	1854	73.0"	2000	2.62	1315	2900			
D	1540	60.0"	1854	73.0"	2200	3.00	1400	3087			

N/S = Not Significant for Utility, Utility Light and Ditch Cleaning Bucket.

Model	Bucket Type	Bucket Family	Bucket Bite Width		Bucket Tip Radius		Heaped Capacity		Bucket Weight With Teeth	
			mm	in	mm	in	L	yd ³	kg	lb
322B (cont'd)	Excavation	B	1260	50.0"	1409	55.4"	900	1.18	760	1680
		S	1225	48.0"	1550	61.0"	1000	1.30	780	1720
		S	1355	53.0"	1550	61.0"	1100	1.40	850	1870
		S	1315	52.0"	1550	61.0"	1200	1.60	870	1920
		S	750	29.5"	1550	61.0"	630	0.82	694	1530
		S	1000	39.4"	1550	61.0"	950	1.24	780	1720
		S	1150	45.3"	1550	61.0"	1150	1.50	874	1930
		S	1250	49.2"	1550	61.0"	1250	1.64	903	1990
		S	1350	53.1"	1550	61.0"	1400	1.83	940	2070
		S	1600	63.0"	1550	61.0"	1700	2.22	1120	2470
		D	1345	53.0"	1660	65.4"	1300	1.70	1115	2460
		D	1430	56.0"	1660	65.4"	1400	1.80	1180	2600
		D	1500	59.0"	1660	65.4"	1500	2.00	1190	2630
		D	750	29.5"	1660	65.4"	660	0.86	924	2040
		D	1000	39.4"	1660	65.4"	1000	1.31	1015	2240
		D	1150	45.3"	1660	65.4"	1300	1.70	1120	2470
		D	1300	51.2"	1660	65.4"	1450	1.90	1150	2540
		D	1350	53.1"	1660	65.4"	1500	1.96	1214	2680
	D	1500	59.1"	1660	65.4"	1700	2.22	1307	2880	
	D	1650	65.0"	1660	65.4"	1900	2.49	1390	3065	
	Extreme Service Excavation	S	750	29.5"	1550	61.0"	630	0.82	722	1590
		S	1000	39.4"	1550	61.0"	950	1.24	865	1910
		S	1150	45.3"	1550	61.0"	1150	1.50	940	2070
		S	1250	49.2"	1550	61.0"	1250	1.64	980	2160
		S	1350	53.1"	1550	61.0"	1400	1.83	1025	2260
		S	1450	57.1"	1550	61.0"	1500	1.96	1085	2390
		S	1600	63.0"	1550	61.0"	1700	2.22	1150	2535
		D	750	29.5"	1660	65.4"	660	0.86	924	2040
		D	1000	39.4"	1660	65.4"	1000	1.31	1108	2440
		D	1150	45.3"	1660	65.4"	1300	1.70	1260	2780
		D	1250	49.2"	1660	65.4"	1500	1.96	1370	3020
		D	1500	59.1"	1660	65.4"	1700	2.22	1480	3260
	Heavy Duty	B	625	24.0"	1563	61.5"	500	0.62	578	1274
		B	775	30.0"	1563	61.5"	600	0.75	656	1446
		B	932	36.0"	1563	61.5"	800	1.00	785	1730
		B	1082	42.0"	1563	61.5"	1000	1.30	850	1870
B		1230	48.0"	1551	61.0"	1200	1.60	955	2100	
B		1377	54.0"	1551	61.0"	1400	1.80	1020	2250	
B		1507	60.0"	1551	61.0"	1500	2.00	1075	2370	
B		1725	68.0"	1203	47.3"	1200	1.60	715*	1580	

*Weight without teeth.

Model	Bucket Type	Bucket Family	Bucket Bite Width		Bucket Tip Radius		Heaped Capacity		Bucket Weight With Teeth	
			mm	in	mm	in	L	yd ³	kg	lb
322B (cont'd)	Heavy Duty	S	625	24.0"	1551	61.0"	500	0.62	609	1343
		S	625	24.0"	1551	61.0"	500	0.62	630	1390
		S	775	30.0"	1638	64.4"	700	0.90	840	1850
		S	948	36.0"	1638	64.4"	900	1.20	955	2100
		S	1098	42.0"	1638	64.4"	1100	1.40	1055	2330
		S	1248	48.0"	1638	64.4"	1300	1.70	1135	2500
		S	1378	54.0"	1518	60.0"	1200	1.50	1088	2399
		S	1395	54.0"	1638	64.4"	1500	2.00	1235	2720
		S	1522	60.0"	1638	64.4"	1700	2.20	1330	2930
		D	775	30.0"	1764	69.4"	700	1.00	875	1929
		D	925	36.0"	1764	69.4"	900	1.25	968	2134
		D	1098	42.0"	1764	69.4"	1200	1.60	1150	2530
		D	1246	49.0"	1764	69.4"	1400	1.80	1290	2840
		D	1400	55.0"	1764	69.4"	1600	2.10	1435	3170
		D	1440	57.0"	1695	66.7"	1500	2.00	1368	3016
		D	1540	60.0"	1764	69.4"	1800	2.40	1565	3450
	D	1695	66.0"	1764	69.4"	2000	2.75	1493	3292	
	D	1820	72.0"	1764	69.4"	2200	3.00	1620	3572	
	Rock	S	750	29.5"	1550	61.0"	630	0.82	764	1685
		S	1000	39.4"	1550	61.0"	950	1.24	904	1990
		S	1350	53.1"	1550	61.0"	1400	1.83	1076	2370
		D	750	29.5"	1660	65.4"	660	0.86	974	2150
		D	1000	39.4"	1660	65.4"	1000	1.31	1160	2560
		D	1650	65.0"	1660	65.4"	1900	2.49	1632	3600
	Heavy Duty Rock	B	775	30.0"	1563	61.5"	600	0.75	759	1674
		B	932	36.0"	1563	61.5"	800	1.00	863	1903
		B	1082	42.0"	1563	61.5"	1000	1.25	949	2093
		S	948	36.0"	1638	64.5"	900	1.25	988	2179
S		1098	42.0"	1638	64.5"	1100	1.50	1084	2390	
S		1248	48.0"	1638	64.5"	1300	1.75	1165	2569	
D		1098	42.0"	1764	69.4"	1200	1.50	1293	2851	
D		1246	48.0"	1764	69.4"	1400	1.88	1436	3166	
D		1400	55.0"	1764	69.4"	1600	2.12	1552	3422	
Rock Ripping	D	900	35.0"	1746	69.0"	700	0.88	1123	2471	
Ditch Cleaning	S	2000	78.7"	N/S		730	0.95	820	1810	
	S	2200	86.6"	N/S		805	1.05	880	1940	
	S	2400	94.5"	N/S		880	1.15	980	2160	
	D	2200	86.6"	N/S		1080	1.41	1210	2670	
	D	2400	94.5"	N/S		1180	1.54	1290	2840	
	D	2600	102.4"	N/S		1280	1.67	1370	3020	
	B	1422	60.0"	1143	45.0"	900	1.12	681	1502	
	B	1727	72.0"	1143	45.0"	1100	1.50	786	1733	
	S	1575	60.0"	1130	44.5"	1000	1.38	739	1629	
	S	1829	72.0"	1130	44.5"	1200	1.62	857	1890	
	D	1676	66.0"	1410	55.5"	1700	2.25	1188	2620	
D	1829	72.0"	1410	55.5"	1800	2.38	1247	2750		

N/S = Not Significant for Utility, Utility Light and Ditch Cleaning Bucket.

Model	Bucket Type	Bucket Family	Bucket Bite Width		Bucket Tip Radius		Heaped Capacity		Bucket Weight With Teeth	
			mm	in	mm	in	L	yd ³	kg	lb
322B (cont'd)	Utility	S	1600	63.0"	N/S		940	1.23	970	2140
		S	1800	70.9"	N/S		1065	1.39	1060	2340
		S	2000	78.7"	N/S		1190	1.56	1140	2510
		S	2200	86.6"	N/S		1315	1.72	1220	2690
		D	1800	70.9"	N/S		1385	1.81	1490	3285
		D	2100	82.7"	N/S		1630	2.13	1600	3530
		D	2400	94.5"	N/S		1875	2.45	1840	4060
	D	2700	106.3"	N/S		2120	2.77	2020	4450	
	Utility Light	S	1600	63.0"	N/S		940	1.23	730	1610
		S	1800	70.9"	N/S		1065	1.39	800	1760
		S	2000	78.7"	N/S		1190	1.56	860	1900
		S	2200	86.6"	N/S		1315	1.72	920	2030
		D	1800	70.9"	N/S		1385	1.81	1120	2470
		D	2100	82.7"	N/S		1630	2.13	1250	2760
D		2400	94.5"	N/S		1875	2.45	1380	3040	
D	2700	106.3"	N/S		2120	2.77	1510	3330		
325B	General Purpose	C	775	30.0"	1778	70.0"	800	1.12	803	1767
		C	948	36.0"	1778	70.0"	1100	1.50	890	1958
		C	1098	42.0"	1778	70.0"	1300	1.75	951	2092
		C	1248	48.0"	1778	70.0"	1600	2.12	1046	2301
		C	1395	54.0"	1778	70.0"	1900	2.50	1116	2455
		D	775	30.0"	1854	73.0"	800	1.12	947	2083
		D	925	36.0"	1854	73.0"	1100	1.50	1024	2253
		D	1098	42.0"	1854	73.0"	1400	1.88	1116	2455
		D	1246	48.0"	1854	73.0"	1700	2.25	1146	2521
		D	1400	55.0"	1854	73.0"	1900	2.50	1192	2622
	D	1540	60.0"	1854	73.0"	2200	3.00	1400	3080	
	Excavation	C	750	29.5"	1550	61.0"	630	0.82	694	1530
		C	1000	39.4"	1550	61.0"	950	1.24	780	1720
		C	1150	45.3"	1550	61.0"	1150	1.50	874	1930
		C	1250	49.2"	1550	61.0"	1250	1.64	903	1990
		C	1350	53.1"	1550	61.0"	1400	1.83	940	2070
		C	1370	54.0"	1487	58.5"	1100	1.44	940	2070
		C	1450	57.1"	1550	61.0"	1500	1.96	990	2180
		C	1470	58.0"	1487	58.5"	1200	1.57	895	1970
		C	1600	63.0"	1550	61.0"	1700	2.22	1045	2300
D		750	29.5"	1660	65.3"	660	0.86	924	2040	
D	1000	39.4"	1660	65.3"	1000	1.31	1015	2240		
D	1150	45.3"	1660	65.3"	1300	1.70	1120	2470		
D	1300	51.2"	1660	65.3"	1450	1.90	1150	2540		
D	1350	53.1"	1660	65.3"	1500	1.96	1214	2680		
D	1430	56.0"	1660	65.4"	1400	1.83	1195	2640		
D	1500	59.0"	1660	65.4"	1500	1.96	1160	2560		
D	1500	59.1"	1660	65.3"	1700	2.22	1307	2880		
D	1650	65.0"	1660	65.3"	1900	2.49	1390	3060		

N/S = Not Significant for Utility, Utility Light and Ditch Cleaning Bucket.

Model	Bucket Type	Bucket Family	Bucket Bite Width		Bucket Tip Radius		Heaped Capacity		Bucket Weight With Teeth		
			mm	in	mm	in	L	yd ³	kg	lb	
325B (cont'd)	Extreme Service Excavation	C	775	30.0"	1638	64.4"	700	0.92	850	1880	
		C	948	36.0"	1638	64.4"	900	1.18	970	2130	
		C	1098	42.0"	1638	64.4"	1100	1.44	1060	2340	
		C	1248	48.0"	1638	64.4"	1300	1.70	1140	2510	
		C	1395	54.0"	1638	64.4"	1500	1.96	1240	2730	
		C	1522	60.0"	1638	64.4"	1700	2.22	1335	2940	
		C	1680	66.0"	1638	64.4"	1900	2.49	1470	3240	
		C	750	29.5"	1550	61.0"	630	0.82	722	1590	
		C	1000	39.4"	1550	61.0"	950	1.24	863	1900	
		C	1150	45.3"	1550	61.0"	1150	1.50	940	2070	
		C	1250	49.2"	1550	61.0"	1250	1.64	980	2160	
		C	1350	53.1"	1550	61.0"	1400	1.83	1025	2260	
		C	1450	57.1"	1550	61.0"	1500	1.96	1085	2390	
		C	1600	63.0"	1550	61.0"	1700	2.22	1154	2540	
		D	1098	42.0"	1764	69.4"	1200	1.50	1150	2530	
		D	1246	48.0"	1764	69.4"	1400	1.88	1290	2840	
		D	1400	55.0"	1764	69.4"	1600	2.12	1390	3060	
		D	1540	60.0"	1764	69.4"	1800	2.50	1500	3310	
		D	1695	66.0"	1764	69.4"	2000	2.62	1650	3640	
		D	1820	72.0"	1764	69.4"	2200	2.88	1800	3970	
	D	750	29.5"	1660	65.3"	660	0.86	924	2040		
	D	1000	39.4"	1660	65.3"	1000	1.31	1108	2440		
	D	1150	45.3"	1660	65.3"	1300	1.70	1260	2780		
	D	1250	49.2"	1660	65.3"	1500	1.96	1370	3020		
	D	1500	59.1"	1660	65.3"	1700	2.22	1480	3260		
	D	1650	65.0"	1660	65.3"	1900	2.49	1571	3460		
		Mass Excavation	C	1440	57.0"	1487	58.5"	1300	1.70	940	2060
			C	1530	60.0"	1487	58.5"	1500	1.96	1050	2310
			D	1520	60.0"	1660	65.4"	1600	2.09	1330	2930
			D	1700	67.0"	1660	65.4"	1900	2.49	1325	2920
		Heavy Duty	C	775	30.0"	1638	64.5"	700	0.88	792	1742
			C	948	36.0"	1638	64.5"	900	1.25	888	1954
			C	1098	42.0"	1638	64.5"	1100	1.50	962	2116
			C	1378	54.0"	1518	60.0"	1200	1.50	1082	2380
			C	1248	48.0"	1638	64.5"	1300	1.75	1037	2281
			C	1395	54.0"	1638	64.5"	1500	2.00	1119	2462
	C		1522	60.0"	1638	64.5"	1700	2.25	1195	2629	
	C		1680	66.0"	1638	64.5"	1900	2.50	1281	2818	
	D		775	30.0"	1764	69.0"	700	1.00	875	1925	
	D		925	36.0"	1764	69.0"	900	1.25	968	2130	
	D		1098	42.0"	1764	69.0"	1200	1.50	1079	2374	
	D		1246	48.0"	1764	69.0"	1400	1.88	1206	2653	
	D		1440	57.0"	1695	67.0"	1500	2.00	1330	2926	
	D		1400	55.0"	1764	69.0"	1600	2.12	1306	2873	
	D		1540	60.0"	1764	69.0"	1800	2.50	1407	3095	
	D		1695	66.0"	1764	69.0"	2000	2.75	1493	3285	
	D	1820	72.0"	1764	69.0"	2200	3.00	1620	3564		

Model	Bucket Type	Bucket Family	Bucket Bite Width		Bucket Tip Radius		Heaped Capacity		Bucket Weight With Teeth	
			mm	in	mm	in	L	yd ³	kg	lb
325B (cont'd)	Trenching	C	1075	42.0"	1550	61.0"	1000	1.31	800	1760
		D	1225	48.0"	1730	68.1"	1400	1.83	1165	2560
		D	1400	55.1"	1730	68.1"	1600	2.09	1120	2470
	Rock	C	750	29.5"	1550	61.0"	630	0.82	764	1680
		C	1000	39.4"	1550	61.0"	950	1.24	552	1220
		C	1350	53.1"	1550	61.0"	1400	1.83	1076	2370
		D	750	29.5"	1660	65.3"	660	0.86	974	2150
		D	1000	39.4"	1660	65.3"	1000	1.31	1160	2560
		D	1650	65.0"	1660	65.3"	1900	2.49	1632	3600
	Heavy Duty Rock	C	948	36.0"	1638	64.5"	900	1.25	1000	2200
		C	1098	42.0"	1638	64.5"	1100	1.50	1084	2385
		C	1248	48.0"	1638	64.5"	1300	1.75	1168	2570
		D	1098	42.0"	1764	69.0"	1200	1.50	1294	2847
		D	1246	48.0"	1764	69.0"	1400	1.88	1437	3161
		D	1400	55.0"	1764	69.0"	1600	2.12	1553	2417
	Rock Ripping	C	850	33.0"	1660	65.0"	600	0.75	1084	2385
		D	900	35.0"	1746	69.0"	700	0.88	1123	2471
	Ditch Cleaning	C	2000	78.7"		N/S	730	0.95	820	1810
		C	2200	86.6"		N/S	805	1.05	880	1940
		C	2400	94.5"		N/S	880	1.15	980	2160
		C	1676	66.0"	1132	45.0"	1100	1.50	813	1789
		C	1829	72.0"	1132	45.0"	1200	1.62	860	1892
		D	2200	86.6"		N/S	1080	1.41	1210	2670
		D	2400	94.5"		N/S	1180	1.54	1290	2840
		D	2600	102.4"		N/S	1280	1.67	1370	3020
		D	1676	66.0"	1424	56.0"	1700	2.25	1192	2622
		D	1829	72.0"	1424	56.0"	1800	2.50	1239	2726
	Utility	C	1600	63.0"		N/S	940	1.23	970	2140
		C	1800	70.9"		N/S	1065	1.39	1060	2340
		C	2000	78.7"		N/S	1190	1.56	1140	2510
C		2200	86.6"		N/S	1315	1.72	1220	2690	
D		1800	70.9"		N/S	1385	1.81	1490	3285	
D		2100	82.7"		N/S	1630	2.13	1600	3530	
D		2400	94.5"		N/S	1875	2.45	1840	4060	
D		2700	106.3"		N/S	2120	2.77	2020	4450	
Utility Light	C	1600	63.0"		N/S	940	1.23	730	1610	
	C	1800	70.9"		N/S	1065	1.39	800	1760	
	C	2000	78.7"		N/S	1190	1.56	860	1900	
	C	2200	86.6"		N/S	1315	1.72	920	2030	
	D	1800	70.9"		N/S	1385	1.81	1120	2470	
	D	2100	82.7"		N/S	1630	2.13	1250	2760	
	D	2400	94.5"		N/S	1875	2.43	1380	3040	
	D	2700	106.3"		N/S	2120	2.77	1510	3330	

N/S = Not Significant for Utility, Utility Light and Ditch Cleaning Bucket.

Model	Bucket Type	Bucket Family	Bucket Bite Width		Bucket Tip Radius		Heaped Capacity		Bucket Weight With Teeth	
			mm	in	mm	in	L	yd ³	kg	lb
330B	General Purpose	D	775	30.0"	1854	73.0"	800	1.12	947	2083
		D	925	36.0"	1854	73.0"	1100	1.50	1024	2253
		D	1098	42.0"	1854	73.0"	1400	1.88	1116	2455
		D	1246	48.0"	1854	73.0"	1700	2.25	1146	2521
		D	1400	55.0"	1854	73.0"	2000	2.62	1192	2622
		D	1540	60.0"	1854	73.0"	2200	3.00	1400	3080
	Excavation	D	1345	53.0"	1660	65.4"	1300	1.70	1115	2460
		D	1430	56.0"	1660	65.4"	1400	1.83	1195	2640
		D	1500	59.0"	1660	65.4"	1500	1.96	1160	2560
		D	750	29.5"	1660	65.4"	660	0.86	924	2040
		D	1000	39.4"	1660	65.4"	1000	1.31	1015	2240
		D	1150	45.3"	1660	65.4"	1300	1.70	1120	2470
		D	1300	51.2"	1660	65.4"	1450	1.90	1150	2540
		D	1350	53.1"	1660	65.4"	1500	1.96	1214	2680
		D	1500	59.1"	1660	65.4"	1700	2.22	1307	2880
		D	1650	65.0"	1660	65.4"	1900	2.49	1390	3065
		E	1470	58.0"	1845	72.1"	1700	2.22	1470	3240
		E	1600	63.0"	1845	72.1"	1900	2.49	1545	3410
		E	1400	55.1"	1780	70.0"	1700	2.22	1490	3285
		E	1500	59.1"	1780	70.0"	1900	2.49	1590	3505
	E	1650	65.0"	1780	70.0"	2100	2.75	1730	3815	
	Extreme Service Excavation	D	775	30.0"	1764	69.4"	700	1.00	955	2100
		D	925	36.0"	1764	69.4"	900	1.25	1045	2310
		D	1098	42.0"	1764	69.4"	1200	1.50	1185	2610
		D	1246	48.0"	1764	69.4"	1400	1.88	1335	2950
		D	1400	55.0"	1764	69.4"	1600	2.12	1435	3170
		D	1540	60.0"	1764	69.4"	1800	2.50	1565	3450
		D	1695	66.0"	1764	69.4"	2000	2.62	1650	3640
		D	1820	72.0"	1764	69.4"	2200	2.88	1800	3970
		D	750	29.5"	1660	65.4"	660	0.86	924	2040
		D	1000	39.4"	1660	65.4"	1000	1.31	1108	2440
		D	1150	45.3"	1660	65.4"	1300	1.70	1260	2780
		D	1250	49.2"	1660	65.4"	1500	1.96	1370	3020
		D	1500	59.1"	1660	65.4"	1700	2.22	1480	3260
		D	1650	65.0"	1660	65.4"	1900	2.49	1571	3460
		E	1400	55.1"	1780	70.0"	1700	2.22	1490	3285
E		1500	59.1"	1780	70.0"	1900	2.49	1590	3505	
E		1650	65.0"	1780	70.0"	2100	2.75	1730	3815	
Mass Excavation		D	1520	60.0"	1660	65.4"	1600	2.09	1330	2930
	D	1700	67.0"	1660	65.4"	1900	2.49	1325	2920	
	E	1735	68.0"	1845	72.1"	2100	2.75	1710	3770	

Model	Bucket Type	Bucket Family	Bucket Bite Width		Bucket Tip Radius		Heaped Capacity		Bucket Weight With Teeth	
			mm	in	mm	in	L	yd ³	kg	lb
330B (cont'd)	Heavy Duty	D	775	30.0"	1764	69.0"	700	1.00	875	1925
		D	925	36.0"	1764	69.0"	900	1.25	968	2130
		D	1098	42.0"	1764	69.0"	1200	1.50	1079	2374
		D	1246	48.0"	1764	69.0"	1400	1.88	1206	2653
		D	1440	57.0"	1695	67.0"	1500	2.00	1330	2926
		D	1440	55.0"	1764	69.0"	1600	2.12	1306	2873
		D	1540	60.0"	1764	69.0"	1800	2.50	1407	3095
		D	1695	66.0"	1764	69.0"	2000	2.75	1493	3285
		D	1820	72.0"	1764	69.0"	2200	2.88	1620	3564
		E	1695	66.0"	1764	69.0"	2400	3.14	2119	4660
	E	1820	72.0"	1764	69.0"	2600	3.40	2246	4940	
	Trenching	D	1400	55.0"	1730	68.1"	1600	2.09	1120	2470
	Rock	D	750	29.5"	1660	65.4"	660	0.86	974	2150
		D	1000	39.4"	1660	65.4"	1000	1.31	1160	2560
		D	1650	65.0"	1660	65.4"	1900	2.49	1632	3600
		E	1500	59.1"	1780	70.0"	1900	2.49	1690	3730
	Heavy Duty Rock	D	1098	42.0"	1764	69.0"	1200	1.50	1294	2847
		D	1246	48.0"	1764	69.0"	1400	1.88	1437	3161
		D	1400	55.0"	1764	69.0"	1600	2.12	1552	3414
	Rock Ripping	D	900	35.0"	1764	69.0"	700	0.88	1123	2471
	Ditch Cleaning	D	2200	86.6"	N/S		1080	1.41	1210	2670
		D	2400	94.5"	N/S		1180	1.54	1290	2840
		D	2600	102.4"	N/S		1280	1.67	1370	3020
		D	1676	66.0"	1424	56.0"				
		D	1829	72.0"	1424	56.0"				
	Utility	D	1800	70.9"	N/S		1385	1.81	1490	3285
		D	2100	82.7"	N/S		1630	2.13	1600	3530
		D	2400	94.5"	N/S		1875	2.45	1840	4060
		D	2700	106.3"	N/S		2120	2.77	2020	4450
	Utility Light	D	1800	70.9"	N/S		1385	1.81	1120	2470
		D	2100	82.7"	N/S		1630	2.13	1250	2760
		D	2400	94.5"	N/S		1875	2.45	1380	3040
		D	2700	106.3"	N/S		2120	2.77	1510	3330
345B	Trenching	F	1075	42.0"	1925	75.8"	1300	1.70	1475	3250
		F	1218	48.0"	1925	75.8"	1600	2.09	1563	3450
		F	1410	56.0"	1925	75.8"	1900	2.49	1756	3870
	Excavation	T	1580	62.0"	1820	71.7"	1900	2.49	1728	3810
		U	1650	65.0"	1860	73.2"	2100	2.75	2212	4880
		F	1590	63.0"	1870	73.6"	2000	2.62	1814	4000
		F	1735	68.0"	1870	73.6"	2200	2.88	1921	4240
		G	1655	65.0"	1958	77.1"	2200	2.88	2172	4790
		G	1770	70.0"	1958	77.1"	2400	3.14	2292	5050
	Mass Excavation	G	1895	75.0"	1958	77.1"	2600	3.40	2434	5370

N/S = Not Significant for Utility, Utility Light and Ditch Cleaning Bucket.

Model	Bucket Type	Bucket Family	Bucket Bite Width		Bucket Tip Radius		Heaped Capacity		Bucket Weight With Teeth		
			mm	in	mm	in	L	yd ³	kg	lb	
345B (cont'd)	Extreme Service Excavation	T	1560	61.0"	1862	73.3"	1900	2.49	1950	4300	
		T	1605	63.0"	1862	73.3"	2000	2.62	2091	4610	
		T	1665	66.0"	1862	73.3"	2100	2.75	2138	4710	
		F	1600	63.0"	1870	73.6"	2000	2.62	1988	4380	
		F	1600	63.0"	1925	75.8"	2100	2.75	2027	4470	
	V-Type Excavation	U	1830	72.0"	1860	73.2"	2100	2.75	2394	5280	
		G	1750	69.0"	1972	77.6"	2200	2.89	2519	5550	
		G	1880	74.0"	1972	77.6"	2400	3.14	2630	5800	
	350	Excavation	F	925	36.4"	2011	79.2"	1100	1.38	1636	3607
			F	1075	42.3"	2011	79.2"	1400	1.75	1724	3800
F			1225	48.2"	1965	77.4"	1700	2.25	1701	3750	
F			1250	49.2"	1900	74.8"	1800	2.35	1650	3640	
F			1350	53.1"	1900	74.8"	2000	2.62	1750	3860	
F			1375	54.1"	1965	77.4"	2000	2.63	1837	4050	
F			1450	57.1"	1900	74.8"	2200	2.88	1995	4400	
F			1525	60.0"	1965	77.4"	2300	3.00	1953	4306	
F			1590	62.6"	1870	73.6"	2000	2.62	1842	4060	
F			1600	63.0"	1900	74.8"	2500	3.27	2175	4800	
F			1700	67.0"	1900	74.8"	2700	3.53	2190	4830	
F			1735	68.3"	1870	73.6"	2200	2.88	1954	4310	
F			1800	70.9"	1900	74.8"	2700	3.53	2310	5090	
G			1450	57.1"	2000	78.7"	2400	3.14	2090	4610	
G			1550	61.0"	2000	78.7"	2600	3.40	2145	4730	
G			1650	65.0"	2000	78.7"	2800	3.66	2270	5005	
G			1655	65.2"	1958	77.1"	2200	2.88	2224	4900	
G			1770	69.7"	1958	77.1"	2400	3.14	2237	4930	
G		1800	70.9"	2000	78.7"	3100	4.05	2410	5310		
Extreme Service Excavation		G	1800	70.9"	2000	78.7"	3100	4.05	2405	5300	
V-Type Excavation		G	1750	68.9"	1958	77.1"	2200	2.88	2503	5520	
		G	1880	74.0"	1958	77.1"	2400	3.14	2606	5750	
Mass Excavation		G	1895	74.6"	1958	77.1"	2600	3.50	2479	5470	
Trenching		F	1075	42.3"	1925	75.8"	1300	1.75	1507	3320	
		F	1218	48.0"	1925	75.8"	1600	2.12	1601	3530	
		F	1410	55.5"	1925	75.8"	1900	2.50	1789	3940	
		F	1225	48.2"	1965	77.4"	1700	2.25	1571	3456	
		F	1375	54.1"	1965	77.4"	2000	2.63	1707	3755	
Extreme Service Trenching		F	925	36.4"	2011	79.0"	1100	1.38	1534	3375	
		F	1075	42.3"	2011	79.0"	1400	1.75	1622	3568	
	F	1259	49.6"	2011	79.0"	1700	2.25	1857	4094		
	F	1525	60.0"	2011	79.0"	2300	3.00	2101	4622		
	F	1600	63.0"	1870	73.6"	2000	2.63	1963	4330		
	F	1600	63.0"	1925	75.8"	2100	2.75	2015	4440		

Model	Bucket Type	Bucket Family	Bucket Bite Width		Bucket Tip Radius		Heaped Capacity		Bucket Weight With Teeth	
			mm	in	mm	in	L	yd ³	kg	lb
350 (cont'd)	Rock	F	953	37.5"	1870	73.6"	900	1.25	2190	4829
		F	1350	53.1"	1900	74.8"	2000	2.62	2100	4630
		F	1450	57.1"	1900	74.8"	2200	2.88	2205	4860
		F	1600	63.0"	1900	74.8"	2500	3.27	2370	5225
		G	1750	68.9"	2050	80.7"	2800	3.66	2770	6110
		G	1750	68.9"	2050	80.7"	2800	3.66	2810	6200
		G	1800	70.9"	2050	80.7"	3100	4.05	2962	6530
375	Excavation	H	1800	70.9"	2100	82.7"	2800	3.66	2490	5490
		H	1990	78.3"	2100	82.7"	3200	4.25	2667	5880
		H	1990	78.3"	2210	87.0"	3800	5.00	2975	6559
		H	1750	68.9"	2100	82.7"	3200	4.19	3280	7232
		H	1900	74.8"	2100	82.7"	3600	4.71	3430	7563
		H	1800	70.9"	2300	90.5"	4200	5.49	3720	8203
		J	1750	68.9"	2235	88.0"	3000	3.92	2602	5780
		J	1865	73.4"	2235	88.0"	3200	4.19	3026	6670
		J	2040	80.3"	2235	88.0"	3600	4.75	3223	7110
		J	2210	87.0"	2235	88.0"	4000	5.25	3403	7500
		J	2200	86.6"	2200	86.6"	4400	5.76	4030	8886
		J	2140	84.3"	2200	86.6"	5100	6.67	4120	9085
		J	2300	90.6"	2200	86.6"	5600	7.32	4350	9592
	Extreme Service Excavation	J	2380	93.7"	2200	86.6"	4500	5.89	4420	9746
		J	2380	93.7"	2200	86.6"	5200	6.80	4150	9151
		J	2380	93.7"	2200	86.6"	5200	6.80	4790	10,562
		J	2400	94.5"	2200	86.6"	5200	6.80	4450	9812
	V-Type Excavation	J	2080	81.9"	2235	88.0"	3600	4.75	3879	8550
	Mass Excavation	J*	1744	68.7"	2234	88.0"	3000	4.00	3524	7771
		J*	2064	81.3"	2234	88.0"	3800	5.00	4006	8833
		J	2390	94.1"	2235	88.0"	4400	5.75	3818	8420
		J*	2390	94.1"	2234	88.0"	4400	6.00	4531	9991
		J*	2390	94.1"	2234	88.0"	5400	7.00	4835	10,661
	V-Type Mass Excavation	J	2260	89.0"	2235	88.0"	4000	5.25	4065	8960
	Trenching	H	1380	54.3"	2210	87.0"	2300	3.25	2218	4890
		H*	1535	60.4"	2210	87.0"	2800	3.75	2576	5680
		H	1560	61.4"	2210	87.0"	2700	3.53	2348	5180
		J*	1530	60.2"	2350	92.5"	2800	3.75	2954	6514
		J*	1680	66.1"	2350	92.5"	3200	4.25	3103	6842
	Extreme Service Trenching	H*	1075	42.3"	2309	90.9"	1600	2.13	2096	4611
		H*	1225	48.2"	2309	90.9"	2000	2.63	2251	4952
	Rock	H	1190	46.9"	2137	84.1"	1600	2.00	3254	6589
		H	1220	48.0"	2046	80.6"	1500	1.96	3131	6900
		J	1850	72.8"	2350	92.5"	4200	5.49	3900	8600
		J	1950	76.8"	2350	92.5"	4000	5.23	4420	9746
		J	2000	78.7"	2350	92.5"	4300	5.62	4830	10,650
		J	2380	93.7"	2350	92.5"	5200	6.80	5220	11,510
J		2380	93.7"	2350	92.5"	5200	6.80	5300	11,687	
Heavy Duty Rock	J	2380	93.7"	2350	92.5"	5200	6.80	6032	13,301	

*Available only from U.S.A.

Model	Bucket Type	Bucket Family	Bucket Bite Width		Bucket Tip Radius		Heaped Capacity		Bucket Weight With Teeth	
			mm	in	mm	in	m ³	yd ³	kg	lb
5130B	High Density		2810	111.0"	3038	120.0"	8.5	11.0	8340	18,380
	Rock		2810	111.0"	3038	120.0"	10.5	13.7	10 250	22,600
	Excavation		2810	111.0"	3038	120.0"	10.5	13.7	8940	19,700
	Coal		3500	138.0"	3225	127.0"	13.6	17.8	8760	19,320
	Coal		3680	145.0"	3225	127.0"	18.3	24.0	9430	20,800
5230	Rock		3940	156.0"	3250	128.0"	16.0	21.0	17 140	37,785
	Light Material		3940	156.0"	3250	128.0"	18.0	23.5	19 040	41,975
	Coal		4350	171.0"	3400	134.0"	27.5	36.0	15 420	34,000

- Bucket Fill Factors
- Bucket & Payload

BUCKET PAYLOAD

An excavator's bucket payload (actual amount of material in the bucket on each digging cycle) is dependent on bucket size, shape, curl force, and certain soil characteristics, i.e., the fill factor for that soil. Fill factors for several types of material are listed below.

$$\text{Average Bucket Payload} = (\text{Heaped Bucket Capacity}) \times (\text{Bucket Fill Factor})$$

Material	Fill Factor Range (Percent of heaped bucket capacity)
Moist Loam or Sandy Clay	A — 100-110%
Sand and Gravel	B — 95-110%
Hard, Tough Clay	C — 80-90%
Rock — Well Blasted	60-75%
Rock — Poorly Blasted	40-50%

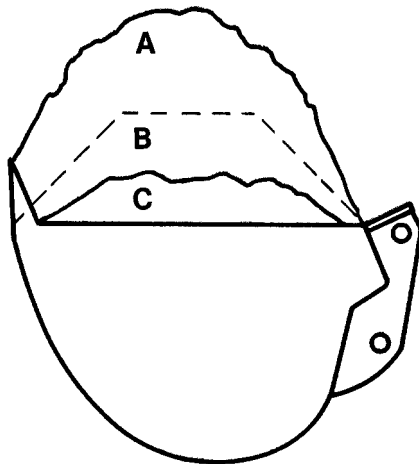

Working Weights — Bucket & Payload

The following tables give maximum "bucket plus payload" weights to assist in selecting the correct bucket for a specific application. These weights are based on actual job conditions. In better than average conditions the excavator may be able to achieve rated lift capacities listed in this section.

NOTE: Bucket sizes are suitable for a maximum material density of 1800 kg/m³ (3035 lb/yd³). Payloads shown are calculated at 1500 kg/m³ (2530 lb/yd³).

Model	Stick Length		kg	lb
	mm	ft		
307B	1665	5'6"	1050	2310
	2210	7'3"	860	1900
307B SB	1665	5'6"	1030	2270
	2210	7'3"	750	1650
307	1665	5'6"	1090	2400
	2210	7'3"	880	1940
311B	1950	6'5"	1560	3440
	2250	7'5"	1470	3240
	2800	9'2"	1230	2710
312B	2100	6'11"	1580	3480
	2500	8'2"	1460	3220
	3000	9'10"	1280	2820
312B L	2100	6'11"	1770	3900
	2500	8'2"	1640	3620
	3000	9'10"	1450	3200
312B L*	2100	6'11"	1740	3830
	2500	8'2"	1595	3510
	3000	9'10"	1450	3190
315B	1850	6'1"	2070	4570
	2250	7'5"	1980	4360
	2600	8'6"	1810	4000
	3100	10'2"	1630	3590
315B L	1850	6'1"	2160	4760
	2250	7'5"	2060	4540
	2600	8'6"	1890	4170
	3100	10'2"	1700	3750
318B L	1800	5'11"	2600	5730
	2250	7'5"	2380	5250
	2700	8'10"	2210	4870
	3200	10'6"	1910	4210
318B LN	1800	5'11"	2230	4920
	2250	7'5"	2030	4480
	2700	8'10"	1900	4190
	3200	10'6"	1630	3590
318B L*/ 318B LN*	1800	5'11"	2440	5380
	2250	7'5"	2250	4960
	2700	8'10"	2160	4760
	3200	10'6"	1810	3990

*France sourced.

Model	Boom	Stick Length		Working Weights† Buckets & Payload		
		m	ft	kg	lb	
320B	Reach	1.90	6'3"	2380	5250	
		2.50	8'2"	2330	5140	
		2.92	9'7"	2150	4740	
		3.86	12'8"	1850	4080	
	Mass	1.90	6'3"	2690	5930	
		2.40	7'10"	2430	5360	
	VA	1.90	6'3"	2870	6330	
		2.40	7'10"	2620	5780	
		2.92	9'7"	2460	5420	
320B L	Reach	1.90	6'3"	2850	6290	
		2.50	8'2"	2750	6070	
		2.92	9'7"	2560	5650	
		3.86	12'8"	2200	4850	
	Mass	1.90	6'3"	3210	7080	
		2.40	7'10"	2910	6420	
	VA	1.90	6'3"	3260	7190	
		2.40	7'10"	2990	6590	
		2.92	9'7"	2790	6150	
	320B N	Reach	1.90	6'3"	2300	5070
			2.50	8'2"	2270	5000
			2.92	9'7"	2090	4610
3.86			12'8"	1800	3970	
Mass		1.90	6'3"	2600	5730	
		2.40	7'10"	2350	5180	
VA		1.90	6'3"	2640	5820	
		2.40	7'10"	2410	5310	
		2.92	9'7"	2280	5030	
322B	Reach	2.50	8'2"	2910	6420	
		2.95	9'8"	2690	5930	
		3.60	11'10"	2320	5120	
	Mass	2.00	6'7"	3390	7480	
2.50		8'2"	3030	6680		
322B L	Reach	2.50	8'2"	3410	7520	
		2.95	9'8"	3160	6970	
		3.60	11'10"	2760	6090	
	Mass	2.00	6'7"	4010	8840	
		2.50	8'2"	3630	8010	
	VA	2.00	6'7"	3750	8270	
		2.50	8'2"	3390	7470	

Model	Boom	Stick Length		Working Weights† Buckets & Payload	
		m	ft	kg	lb
322B N	Reach	2.50	8'2"	2610	5760
		2.95	9'8"	2410	5320
		3.60	11'10"	2070	4570
		2.00	6'7"	3010	6640
	Mass	2.50	8'2"	2690	5930
		2.00	6'7"	2830	6240
VA	2.50	8'2"	2540	5600	
	322B LN	Reach	2.00	6'7"	3240
2.50			8'2"	3150	6940
2.95			9'8"	2910	6420
3.60			11'10"	2710	5970
Mass	2.00	6'7"	3850	8490	
	2.50	8'2"	3430	7560	
VA	2.00	6'7"	3260	7190	
	2.50	8'2"	2950	6500	
325B	Reach	2.00	6'7"	3450	7610
		2.65	8'8"	3140	6930
		3.20	10'6"	2840	6270
	Mass	2.00	6'7"	4090	9020
		2.50	8'2"	3650	8050
	VA	2.00	6'7"	3430	7560
2.50		8'2"	3130	6900	
325B L	Reach	2.00	6'7"	4060	8950
		2.65	8'8"	3680	8120
3.20		10'6"	3360	7410	
Mass	2.00	6'7"	4810	10,610	
	2.50	8'2"	4290	9460	
VA	2.00	6'7"	4090	9020	
	2.50	8'2"	3740	8250	
325B LN	Reach	2.00	6'7"	3530	7790
		2.65	8'8"	3210	7080
3.20		10'6"	2910	6420	
Mass	2.00	6'7"	4180	9220	
	2.50	8'2"	3730	8230	
VA	2.00	6'7"	3490	7690	
	2.50	8'2"	3190	7030	
	3.20	10'6"	2870	6330	

†Working weights may vary depending on machine configuration.
Contact your Caterpillar Dealer for specific information.

Excavators

Working Weights ● Buckets & Payload

Model	Boom	Stick Length		Working Weights† Buckets & Payload	
		m	ft	kg	lb
330B	Reach	2.15	7'1"	4500	9920
		2.80	9'2"	4000	8820
		3.30	10'10"	3690	8140
		3.90	12'10"	3250	7170
	Mass	2.15	7'1"	5030	11,090
		2.55	8'4"	4440	9790
330B L	Reach	2.15	7'1"	4700	10,360
		2.80	9'2"	4160	9170
		3.30	10'10"	3830	8440
		3.90	12'10"	3240	7540
	Mass	2.15	7'1"	5210	11,490
		2.55	8'4"	4640	10,230
330B LN	Reach	2.15	7'1"	4150	9150
		2.80	9'2"	3700	8160
		3.30	10'10"	3410	7520
		3.90	12'10"	3000	6610
	Mass	2.15	7'1"	4660	10,270
		2.55	8'4"	4100	9040
3.50		11'6"	3530	7780	
345B	Reach	2.90	9'6"	5780	12,740
		3.35	11'0"	5210	11,490
		3.90	12'10"	4790	10,560
	Mass	2.50	8'2"	6190	13,650
		3.00	9'10"	5670	12,500
345B L – FIX	Reach	2.90	9'6"	6360	14,020
		3.35	11'0"	5710	12,590
		3.90	12'1"	5320	11,730
	Mass	2.50	8'2"	6780	14,950
		3.00	9'10"	6230	13,730
345B L – VG	Reach	2.90	9'6"	7110	15,670
		3.35	11'0"	6410	14,130
		3.90	12'10"	5990	13,210
	Mass	2.50	8'2"	7650	16,870
		3.00	9'10"	7150	15,760
350	Reach	3.10	10'2"	5800	12,790
		3.60	11'10"	5380	11,860
		4.80	15'9"	4320	9520
	Mass	2.40	7'10"	7110	15,670
		2.95	9'8"	6350	14,000
		3.70	12'2"	5610	12,370
350 L	Reach	3.10	10'2"	6060	13,360
		3.60	11'10"	5610	12,370
		4.80	15'9"	4520	9960
	Mass	2.40	7'10"	7300	16,090
		2.95	9'8"	6640	14,640
		3.70	12'2"	5860	12,920

Model	Boom	Stick Length		Working Weights† Buckets & Payload	
		m	ft	kg	lb
375	Reach	2.90	9'6"	8450	18,630
		3.40	11'2"	7930	17,480
		4.40	14'5"	7570	16,690
		5.50	18'1"	6360	14,020
	General Purpose	3.40	11'2"	8550	18,850
		4.40	14'5"	8080	17,810
5.50		18'1"	6770	14,930	
375 L	Reach	2.90	9'6"	11 120	24,520
		3.40	11'2"	10 430	22,990
		4.10	13'5"	9220	20,330
	General Purpose	2.90	9'6"	8860	19,530
		3.40	11'2"	8330	18,360
		4.40	14'5"	7930	17,480
Mass	5.50	18'1"	6680	14,730	
	3.40	11'2"	8970	19,780	
	4.40	14'5"	8450	18,630	
5130B ME	Mass	5.50	18'1"	7100	15,650
		2.90	9'6"	11 610	25,600
		3.40	11'2"	10 890	24,010
5230 ME	Mass	4.10	13'5"	9650	21,270
		3.80	12'6"	28 500	62,800
		4.50	14'9"	44 500	98,100

†Working weights may vary depending on machine configuration.
Contact your Caterpillar dealer for specific information.

- Introduction
- Range Dimensions
- Bucket Information

INTRODUCTION

Long reach excavators are designed purposely for light duty digging that requires reach capability well above that of normal digging machines. To be able to have high enough digging forces together with an acceptable size bucket, the long reach excavators have a smaller digging envelope than the ditch cleaning machines. Long reach excavators are ideally suited for deep digging in gravel or sand pits then feeding directly into a hopper.

Caterpillar's long reach hydraulic excavators use purpose-built booms and sticks designed by Caterpillar for maximum performance and durability in light duty applications.

Long Reach Excavation Fronts include: boom, stick, linkage cylinders (boom, stick, and bucket), hydraulic lines, additional counterweight for stability over the side and heavy duty wide undercarriage. Dimensions include light excavation bucket.

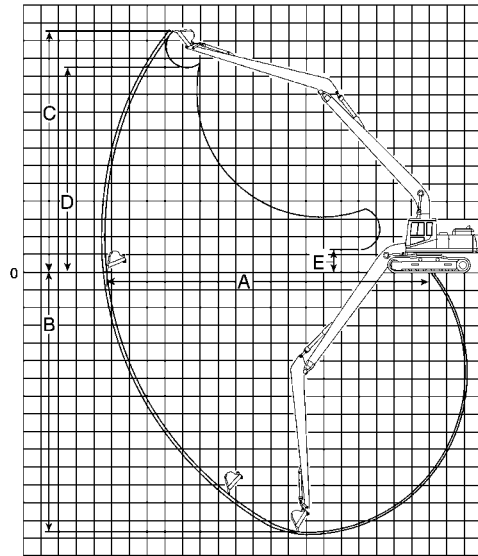

Long Reach Model	325B L		330B L	
	m	ft	m	ft
A Maximum Reach at Ground Level	16.07	52'9"	17.91	58'9"
B Maximum Digging Depth	11.34	37'2"	12.62	41'5"
C Maximum Cutting Height	13.88	45'6"	16.01	52'6"
D Maximum Dumping Height	11.20	36'9"	13.42	44'0"
E Minimum Loading Height	3.15	10'4"	3.55	11'8"

325B L/330B L • Long Reach

Bucket Type	Bucket Width		SAE Heaped Cap.		Bucket Weight		No. of Teeth	Bucket Curl Force		Stick Crowd Force	
	mm	ft	L	yd ³	kg	lb		kN	lb	kN	lb
Excavation	1500	4'11"	1350	1.77	820	1810	6	54.1	12,170	—	—
Ditch Cleaning	1800	5'11"	450	0.59	550	1210	0	—	—	—	—
Ditch Cleaning	2000	6'7"	550	0.72	590	1300	0	—	—	—	—
Ditch Cleaning	2200	7'3"	610	0.80	630	1390	0	—	—	—	—

Excavators

Long Reach

- Shipping Dimensions
- Major Component Weights

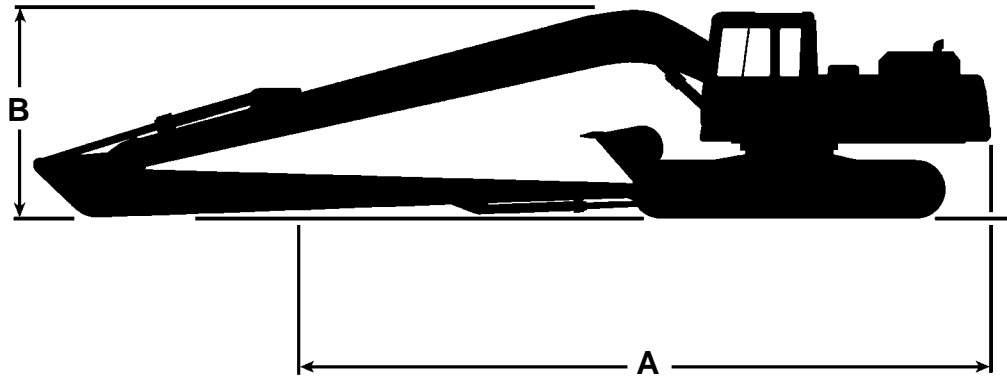

LONG REACH ATTACHMENT SHIPPING DIMENSIONS

Model	325B L		330B L	
	m	ft	m	ft
A Overall Transport Length (Front Folded)	13.59	44'7"	15.45	50'8"
B Overall Height (To Top of Boom)	3.44	11'3"	3.75	12'4"
Overall Width (To Widest Point)	3.72	12'2"	3.72	12'2"

NOTE: For other base machine dimensions, see section on machines with GP attachments.

LONG REACH ATTACHMENT COMPONENT WEIGHTS

Model	325B L		330B L	
	kg	lb	kg	lb
Total Counterweight: Includes Additional over Standard	7700 1272	16,980 2800	8300 1510	18,300 3330
Long Reach Boom: Includes boom, stick cylinder, hydraulic lines, and pins for stick, stick cylinder, and boom rod end	3400	7500	4500	9920
Long Reach Stick: Includes stick, bucket linkage and pins, bucket cylinder and pin, and hydraulic lines	1940	4280	2300	5070

- Introduction
- Range Dimensions
- Bucket Information

INTRODUCTION

Ditch cleaning excavators are designed specifically for those jobs requiring maximum reach well beyond the range of normal excavators. Those machines are designed to drag a small bucket at about 90 degrees over the side of the tracks towards the excavator; they are not suited for digging work. Caterpillar offers the Long Reach excavators for light digging applications with a much larger digging envelope than normal excavators. Ditch cleaning excavators are suited for ditch cleaning, slope finishing, river conservation and other work formerly reserved to draglines.

Caterpillar's ditch cleaning hydraulic excavators use purpose-built booms and sticks designed by Caterpillar for maximum performance and durability in dragging applications.

Ditch Cleaning Fronts include: boom, stick, linkage cylinders (boom, stick, and bucket), hydraulic lines and additional counterweight for stability while working over the side. Dimensions include ditch cleaning bucket.

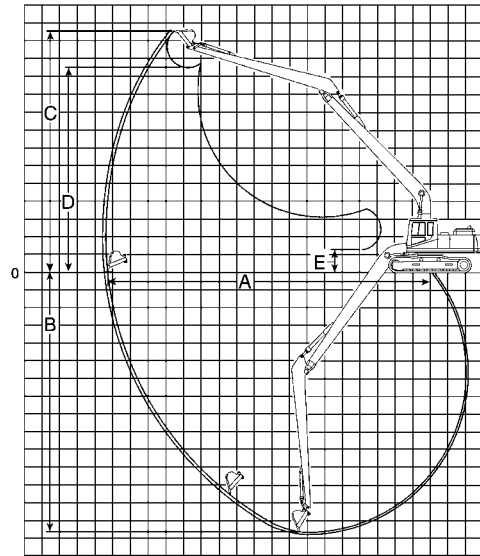

Long Reach Model	320B L		320B L		322B L		325B L	
	m	ft	m	ft	m	ft	m	ft
Source	Japan		Belgium		Japan		Belgium	
A Maximum Reach at Ground Level	15.60	51'2"	15.59	51'2"	18.30	60'0"	18.30	60'0"
B Maximum Digging Depth	11.75	38'7"	11.75	38'7"	14.60	47'11"	15.60	51'2"
C Maximum Cutting Height	13.24	43'5"	13.32	43'8"	14.19	46'7"	13.60	44'7"
D Maximum Dumping Height	11.14	36'7"	11.14	36'7"	12.14	39'10"	11.60	38'1"
E Minimum Loading Height	2.10	6'10"	2.09	6'10"	1.49	4'11"	1.32	4'4"

320B L • Ditch Cleaning • Japan/U.S. Sourced

Bucket Type	Bucket Width		Tip Radius		SAE Heaped Cap.		Bucket Weight		No. of Teeth	Bucket Curl Force		Stick Crowd Force	
	mm	ft/in	mm	ft/in	L	yd ³	kg	lb		kN	lb	kN	lb
General Purpose	810	2'8"	1220	4'0"	450	0.59	340	750	5	60.5	13,600	46.0	10,340
Ditch Cleaning	1140	3'9"	1090	3'7"	600	0.78	290	640	0	54.1	12,170	46.6	10,470

322B L • Ditch Cleaning • Japan/U.S. Sourced

General Purpose	700	2'4"	1220	4'0"	380	0.50	335	740	4	54.1	12,170	50.1	11,270
General Purpose	810	2'8"	1220	4'0"	450	0.59	340	750	5	54.1	12,170	50.1	11,270
Ditch Cleaning	965	3'2"	1090	3'7"	480	0.63	265	580	0	60.5	13,600	50.6	11,380
Ditch Cleaning	1140	3'9"	1090	3'7"	600	0.78	290	640	0	60.5	13,600	50.6	11,380

320 L/325 L • Ditch Cleaning • Belgium Sourced

	810	2'8"	—	—	450	0.59	350	770	—	—	—	—	—
	1800	5'11"	—	—	600	0.78	400	880	—	—	—	—	—

Excavators

Ditch Cleaning

- Shipping Dimensions
- Major Component Weights

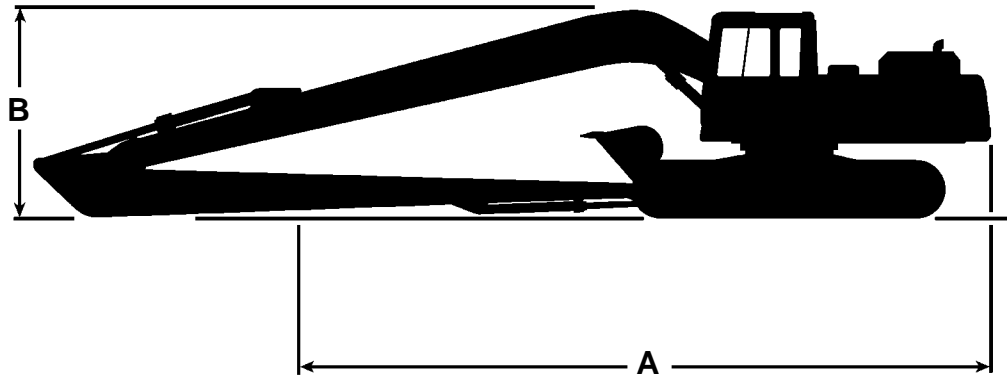

DITCH CLEANING ATTACHMENT SHIPPING DIMENSIONS

Model	320B L		320B L		322B L		325B L*		330B L*	
	m	ft	m	ft	m	ft	m	ft	m	ft
Source	Japan		Belgium		Japan		Belgium		Japan	
A Overall Transport Length (Front Folded)	12.65	41'6"	12.80	42'0"	14.24	46'9"	14.60	47'11"	16.62	54'6"
B Overall Height (To Top of Boom)	3.21	10'6"	3.20	10'6"	3.17	10'5"	3.30	10'10"	3.59	11'9"
Overall Width (To Widest Point)	3.18	10'5"	3.00	9'10"	3.39	11'1"	3.38	11'1"	3.34	10'11"

NOTE: For other base machine dimensions, see section on machines with GP attachments.

DITCH CLEANING ATTACHMENT COMPONENT WEIGHTS

Model	320B L		320B L		322B L		325B L*		330B L*	
	kg	lb	kg	lb	kg	lb	kg	lb	kg	lb
Total Counterweight: Includes Additional over Standard	4810	10,600	4810	10,600	5900	13,010	7700	16,980	7390	16,290
	950	2090	950	2090	1440	3180	1272	2800	—	—
Long Reach Boom: Includes boom, stick cylinder, hydraulic lines, and pins for stick, stick cylinder, and boom rod end	2185	4820	2185	4820	3130	6900	3400	7500	4190	9240
Long Reach Stick: Includes stick, bucket linkage and pins, bucket cylinder and pin, and hydraulic lines	1260	2780	1260	2780	1570	3460	1940	4280	2130	4700

*Custom Product.

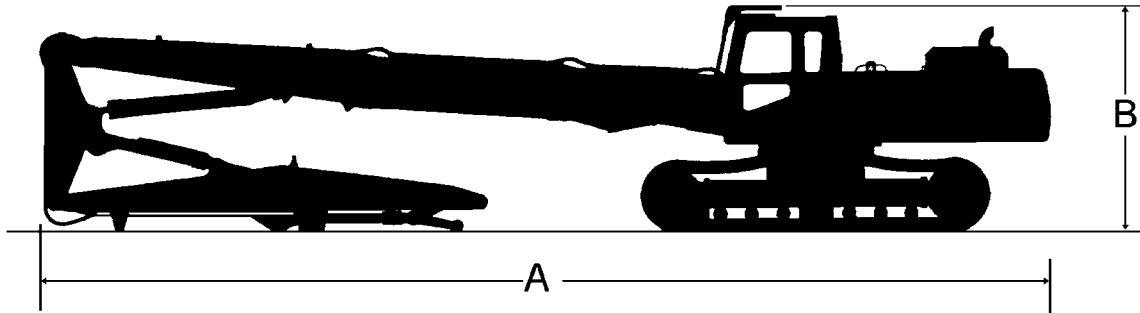

4

Model	325B L		330B L	
	m	ft	m	ft
A Overall Transport Length	12.56	41'2"	14.90	48'11"
B Transport Height	3.33	10'11"	3.34	10'11"
Transport Width with 600 mm (2'0") Shoe	3.19	10'6"	3.19	10'6"

Model	330B LN Hydraulic Gauge		345B L		345B LN Hydraulic Gauge	
	m	ft	m	ft	m	ft
A Overall Transport Length	14.90	48'11"	16.25	53'4"	16.25	53'4"
B Transport Height	3.34	10'11"	3.67	12'0"	3.67	12'0"
Transport Width with 600 mm (2'0") Shoe	2.99	9'10"	2.99	9'10"	2.99	9'10"

*Not available in all sales areas.

**Includes wide gauge undercarriage and 2-piece boom.

● Range Dimensions

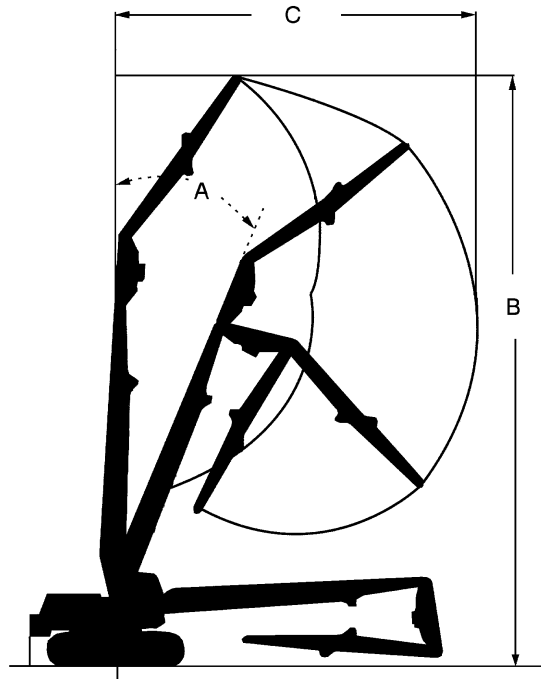

Model	325B L	
A Max. Boom Angle	25°	
	m	ft
B Max. Height	17.10	56'1"
C Max. Reach	11.10	36'5"
Max. Tool Weight	2300 kg	5070 lb

Model	330B L		330B LN Variable Gauge		345B L		345B LN Variable Gauge	
A Boom Angle	25°		25°		25°		25°	
	m	ft	m	ft	m	ft	m	ft
B Max. Height	20.90	68'7"	20.90	68'7"	22.80	74'10"	22.80	74'10"
C Max. Reach	13.80	45'3"	13.80	45'3"	15.30	50'2"	15.30	50'2"
Max. Tool Weight	2300 kg	5070 lb	3000 kg	6610 lb	2300 kg	5070 lb	3000 kg	6610 lb

Demolition Arrangements

- Straight Boom
- Shipping Dimensions
- Belgium Sourced

Excavators

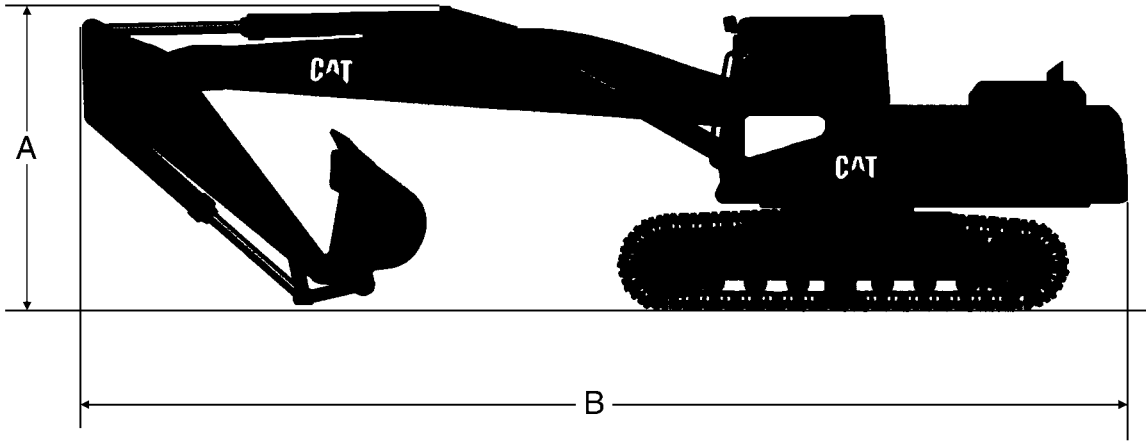

Model	320B				322B			
	m	ft	m	ft	m	ft	m	ft
Stick	2.50	8'2"	2.90	9'6"	2.50	8'2"	2.95	9'8"
A Shipping Height	3.07	10'1"	3.07	10'1"	3.10	10'2"	3.13	10'3"
B Shipping Length	9.70	31'10"	9.70	31'10"	10.42	34'2"	10.36	34'0"

Model	325B				330B			
	m	ft	m	ft	m	ft	m	ft
Stick	2.65	8'8"	3.20	10'6"	3.30	10'10"	3.90	12'10"
A Shipping Height	3.15	10'4"	3.15	10'4"	3.60	11'10"	3.60	11'10"
B Shipping Length	10.30	33'10"	10.30	33'10"	10.50	34'5"	10.70	35'1"

Model	345B L						375 L			
	m	ft	m	ft	m	ft	m	ft	m	ft
Stick	2.90	9'6"	3.40	11'2"	4.00	13'1"	2.90	9'6"	3.40	11'2"
A Shipping Height	3.35	11'0"	3.50	11'6"	3.75	12'4"	4.35	14'3"	4.60	15'1"
B Shipping Length	12.10	39'8"	12.05	39'6"	12.00	39'4"	14.80	48'7"	14.55	47'9"

Excavators

Demolition Arrangements

- Straight Booms
- Range Dimensions
- Belgium Sourced

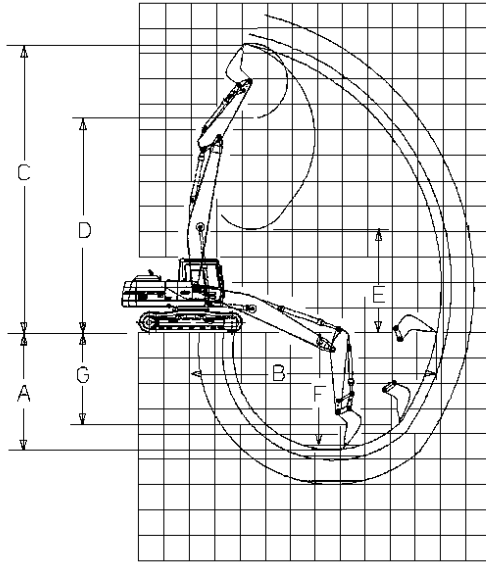

KEY:

- A** Maximum digging depth
- B** Maximum reach @ ground line
- C** Maximum cutting height
- D** Maximum loading height
- E** Minimum loading height
- F** Maximum depth at 2.44 m (8'0") level bottom
- G** Maximum vertical wall depth

Model	320B L				322B			
	m	ft	m	ft	m	ft	m	ft
Boom	6.02	19'9"	6.02	19'9"	6.20	20'4"	6.20	20'4"
Stick	2.50	8'2"	2.92	9'6"	2.50	8'2"	2.95	9'8"
Bucket Tip radius	1.50	4'11"	1.50	4'11"	1.55	5'1"	1.55	5'1"
A	4.64	15'3"	5.06	16'7"	4.50	14'9"	4.94	16'2"
B	9.77	32'1"	10.18	33'5"	10.02	32'10"	10.47	34'4"
C	11.36	37'3"	11.72	38'5"	11.62	38'1"	12.00	39'4"
D	8.45	27'9"	8.81	28'11"	8.54	28'0"	8.92	29'3"
E	4.07	13'4"	3.59	11'9"	4.42	14'6"	3.83	12'7"
F	4.44	14'7"	4.88	16'0"	4.30	14'1"	4.74	15'7"
G	3.60	11'10"	3.93	12'11"	3.40	11'2"	3.80	12'6"

Model	325B				330B			
	m	ft	m	ft	m	ft	m	ft
Boom	6.48	21'3"	6.48	21'3"	6.87	22'6"	6.87	22'6"
Stick	2.65	8'8"	3.20	10'6"	3.30	10'10"	3.90	12'10"
Bucket Tip radius	1.60	5'3"	1.60	5'3"	1.85	6'1"	1.85	6'1"
A	5.54	18'2"	6.09	20'0"	6.06	19'11"	6.66	21'10"
B	10.48	34'5"	11.01	36'1"	11.54	37'10"	12.13	39'10"
C	11.84	38'10"	12.24	40'2"	13.15	43'2"	13.67	44'10"
D	8.63	28'4"	9.03	29'8"	9.70	31'10"	10.23	33'7"
E	4.05	13'3"	3.47	11'5"	3.87	12'8"	3.35	11'0"
F	5.36	17'7"	5.93	19'5"	5.91	19'5"	6.53	21'5"
G	4.76	15'7"	5.24	17'2"	5.04	16'6"	5.52	18'1"

Demolition Arrangements

- Straight Booms
- Range Dimensions
- Belgium Sourced

Excavators

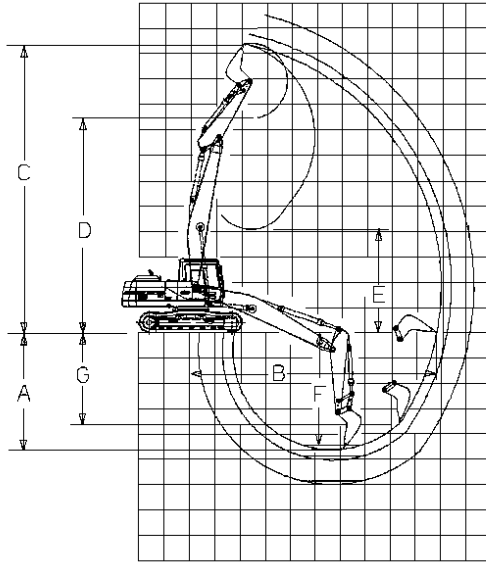

KEY:

- A** Maximum digging depth
- B** Maximum reach @ ground line
- C** Maximum cutting height
- D** Maximum loading height
- E** Minimum loading height
- F** Maximum depth at 2.44 m (8'0") level bottom
- G** Maximum vertical wall depth

4

Model	345B L						375 L					
	m	ft	m	ft	m	ft	m	ft	m	ft	m	ft
Boom	7.20	23'7"	7.20	23'7"	7.20	23'7"	8.80	28'10"	8.80	28'10"	8.80	28'10"
Stick	2.90	9'6"	3.40	11'2"	4.00	13'1"	2.92	9'7"	3.40	11'2"	4.10	13'5"
Bucket Tip radius	1.90	6'3"	1.90	6'3"	1.90	6'3"	2.23	7'4"	2.23	7'4"	2.23	7'4"
A	5.20	17'1"	5.65	18'6"	6.30	20'8"	6.52	21'5"	6.98	22'11"	7.69	25'3"
B	11.80	38'9"	12.25	40'2"	12.90	42'4"	13.85	45'5"	14.30	46'11"	15.00	49'3"
C	13.55	44'5"	13.95	45'9"	14.50	47'7"	15.79	51'10"	16.13	54'11"	16.72	54'10"
D	9.80	32'2"	10.20	33'6"	10.70	35'1"	11.34	37'2"	11.68	38'4"	12.27	40'3"
E	4.75	15'7"	4.35	14'3"	3.75	12'4"	9.29	30'6"	8.86	29'1"	8.23	27'0"
F	5.00	16'5"	5.45	17'11"	6.10	20'0"	6.37	20'11"	6.85	22'6"	7.57	24'10"
G	4.90	16'1"	5.20	17'1"	5.70	18'8"	4.85	15'11"	5.37	17'7"	5.81	19'1"

Excavators

Demolition Arrangements

- Belgium Sourced
- Lift Capacity at Ground Line

320B L

- Straight Boom
- 600 mm (2'0") Track Shoes
- 0.8 m³ (1.05 yd³) Bucket

Stick		3 m 10'0"		4.5 m 15'0"		6 m 20'0"		7.5 m 25'0"		9 m 30'0"		At Max. Reach	
		Front	Side	Front	Side	Front	Side	Front	Side	Front	Side	Front	Side
2.50 m 8'2"	kg lb	—	—	9320* 20,550*	6340 13,990	6980* 15,390*	4160 9180	4960 10,930	2970 6550	—	—	2740* 6040*	2070 4560
2.92 m 9'7"	kg lb	—	—	9600* 21,170*	6350 14,010	7000 15,440	4140 9130	4920 10,850	2930 6470	3040* 6710*	2165 4770	2050* 4530*	1880 4150

322B LN

- Straight Boom
- 600 mm (2'0") Track Shoes
- 1.25 m³ (1.64 yd³) Bucket

Stick		3 m 10'0"		4.5 m 15'0"		6 m 20'0"		7.5 m 25'0"		9 m 30'0"		At Max. Reach	
		Front	Side	Front	Side	Front	Side	Front	Side	Front	Side	Front	Side
2.50 m 8'2"	kg lb	—	—	10 680* 23,550*	6800 15,000	8000 17,650	4390 9680	5570 12,290	3070 6780	—	—	3600* 7940*	2040 4500
2.95 m 9'8"	kg lb	—	—	11 480* 25,320*	6840 15,090	8020 17,700	4400 9700	5570 12,300	3070 6780	4130 9110	2230 4930	3130* 6910*	1860 4100

325B LN

- Straight Boom
- 600 mm (2'0") Track Shoes
- 1.2 m³ (1.57 yd³) Bucket

Stick		3 m 10'0"		4.5 m 15'0"		6 m 20'0"		7.5 m 25'0"		9 m 30'0"		At Max. Reach	
		Front	Side	Front	Side	Front	Side	Front	Side	Front	Side	Front	Side
2.65 m 8'8"	kg lb	—	—	8510* 18,770*	7400 16,330	8650 19,070	4790 10,570	6060 13,360	3390 7470	4520 9970	2490 5490	3760* 8300*	2110 4660
3.20 m 10'6"	kg lb	—	—	10 040* 22,150*	7400 16,330	8650 19,070	4780 10,550	6040 13,320	3360 7420	4490 9900	2450 5420	2960* 6530*	1870 4140

*Load limited by hydraulic capacity rather than tipping.

330B LN

- Straight Boom ● 600 mm (2'0") Track Shoes ● 1.2 m³ (1.57 yd³) Bucket

Stick		4.5 m 15'0"		6 m 20'0"		7.5 m 25'0"		9 m 30'0"		10.5 m 35'0"		At Max. Reach	
		Front	Side	Front	Side	Front	Side	Front	Side	Front	Side	Front	Side
2.80 m 9'2"	kg lb	—	—	12 290* 27,110*	6810 15,020	8630 19,040	4870 10,750	6470 14,270	3630 8020	—	—	5000 11,040	2770 6110
3.30 m 10'10"	kg lb	11 870* 26,170*	10 460 23,060	12 330* 27,180	6810 15,020	8620 19,010	4850 10,700	6440 14,200	3600 7940	—	—	3520* 7770*	2500 5530
3.90 m 12'10"	kg lb	12 750* 28,130*	10 510 23,170	12 580* 27,740*	6830 15,060	8610 19,000	4840 10,670	6410 14,140	3570 7870	4650 10,250	2680 5910	2920* 6450*	2200 4860

345B L

- Straight Boom ● 600 mm (2'0") Track Shoes ● 2.0 m³ (2.62 yd³) Bucket

Stick		4.5 m 15'0"		6 m 20'0"		7.5 m 25'0"		9 m 30'0"		10.5 m 35'0"		At Max. Reach	
		Front	Side	Front	Side	Front	Side	Front	Side	Front	Side	Front	Side
2.90 m 9'6"	kg lb	—	—	13 480* 29,720*	10 780 23,760	10 450* 23,040*	7510 16,550	7900* 17,410*	5530 12,190	—	—	4240* 9340*	4050 8930
3.40 m 11'2"	kg lb	10 790* 23,790*	10 790* 23,790*	14 060* 31,000*	10 780 23,760	10 780* 23,760*	7550 16,640	8240* 18,160*	5530 12,190	5660* 12,480*	4180 9210	4140* 9120*	3720 8200
4.00 m 13'1"	kg lb	12 000* 26,460*	12 000* 26,460*	14 410* 31,770*	10 790 23,790	10 930* 24,100*	7460 16,440	8410* 18,540*	5410 11,920	6270* 13,820*	4020 8860	3180* 7010*	3180* 7010*

*Load limited by hydraulic capacity rather than tipping.

- Track vs. Wheels
- Stick/Bucket Combinations

EXCAVATOR SELECTION: TRACKS VERSUS WHEELS

Features:

Tracks

- Flotation
- Traction
- Maneuverability
- Severe underfoot
- Faster machine repositioning

Wheels

- Mobility and speed
- No pavement damage
- Better stability with outriggers or dozers
- Leveling machine with outriggers
- Dozing capability

307–375

Unless the application calls for a lot of travel to, from, and around the job sites, a track-type excavator could be the better choice. Track-type excavators provide good traction and flotation in almost all kinds of underfoot conditions. Consistently good drawbar power provides excellent maneuverability. The tracked undercarriage also provides good overall stability. If the job calls for frequent machine repositioning, a track-type excavator will provide better operating efficiency — where raising and lowering outriggers would take extra time.

Wheels (M312 and M320)

Looking for a highly versatile machine? A machine that can do more than mass excavation and trenching. Consider a Wheel Excavator.

A Wheel Excavator combines traditional excavator features such as 360° swing, long reach, deep digging depth, high loading height, high digging forces and high lift capacities, with the mobility of

a wheeled undercarriage. The rubber tires allow the excavator to travel paved roads, work in shopping malls, squares, parking lots and other paved areas without damaging the pavement. It's mobility allows fast independent travel between jobsites as well as on the jobsite giving you more job planning flexibility. The Wheel Excavator is the ideal tool for truck loading in tight quarters, undercutting concrete or asphalt, patching, shoulder work, curb and gutter repair, landscaping, spreading top soil, fine grading, laying pipe, placing manholes or ditch cleaning.

A Wheel Excavator is also an ideal machine in material handling. It can load or unload trucks and carry loads around the job site. Stabilizers and a dozer blade can be pinned to the undercarriage increasing the machines stability during lifting.

Equip the Wheel Excavator with dedicated special attachments such as cab riser, material handling stick and boom. Add the additional hydraulic circuit option and your ready for a complete range of special tools. Ditch cleaning bucket, clamshell, grapples, hammers to name a few.

Caterpillar Wheel Excavators offer a load independent, load-sensing, flow distribution hydraulic system that gives the operator absolute precision and control no matter what the application.

Machine weight is the key to selecting a Wheel Excavator. Following are some additional factors that need to be considered.

Choose the proper boom and stick for your reach, digging depth and lifting requirements. Stability can be greatly enhanced by adding outriggers and/or a dozer blade. Additional hydraulic circuits can be added depending on your application and stick end attachments.

Acceptable Bucket/Stick Combinations

The following charts identify the acceptable bucket and stick combinations for Caterpillar Wheel Excavators and are based on stability. Minimum stability occurs with the linkage oriented over the side and positioned as shown in the visual. Dozer and/or stabilizers (if equipped) are raised and the bucket contains a full load. The longest stick is shown that has acceptable stability for each bucket. That stability is 1.1 moment ratio or better. Once this stability factor is established, all shorter sticks are then acceptable with the listed bucket.

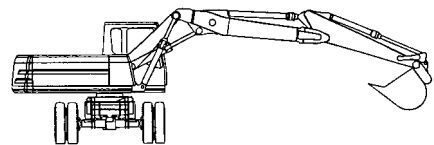

FOR USE WITH 1-PIECE BOOM — UNIQUE M312/M315 BUCKETS

Bucket Bite Width	mm ft/in	450 17.7"	600 1'11.6"	700 2'3.6"	900 2'11.4"	1000 3'3.4"	1100 3'7.3"	1100 3'7.3"	1200 3'11.2"	1200* 3'11.2"
ISO Bucket Capacity	m³ yd³	0.24 0.31	0.33 0.43	0.40 0.52	0.54 0.70	0.61 0.79	0.68 0.88	0.68 0.88	0.75 0.98	0.86 1.12
Bucket Tip Radius	mm ft/in	1240 4'0.8"	1240 4'0.8"	1240 4'0.8"	1240 4'0.8"	1240 4'0.8"	1240 4'0.8"	1220 4'0"	1220 4'0"	1318 4'3.9"
Number of Tips		3	3	4	5	5	6	6	6	5
Weight with Tips	kg lb	271 596	304 669	340 748	365 803	410 902	438 964	472 1038	458 1008	592 1305
Bucket Type ¹		T	T	T	X	X	X	EX	X	EX
Longest Acceptable Stick:										
Dozer Only — Up (FOW ²)	m ft/in	3.1 10'2"	3.1 10'2"	3.1 10'2"	3.1 10'2"	3.1 10'2"	2.6 8'6"	2.6 8'6"	2.4 7'11"	2.4 7'11"
Dozer Only — Down	m ft/in	3.1 10'2"	3.1 10'2"	3.1 10'2"	3.1 10'2"	3.1 10'2"	3.1 10'2"	3.1 10'2"	2.6 8'6"	2.6 8'6"
Rear Outriggers — Down	m ft/in	3.1 10'2"	3.1 10'2"	3.1 10'2"	3.1 10'2"	3.1 10'2"	3.1 10'2"	3.1 10'2"	3.1 10'2"	3.1 10'2"
2 Sets Outriggers — Down	m ft/in	3.1 10'2"	3.1 10'2"	3.1 10'2"	3.1 10'2"	3.1 10'2"	3.1 10'2"	3.1 10'2"	3.1 10'2"	3.1 10'2"
Dozer/Outriggers — Down	m ft/in	3.1 10'2"	3.1 10'2"	3.1 10'2"	3.1 10'2"	3.1 10'2"	3.1 10'2"	3.1 10'2"	3.1 10'2"	3.1 10'2"

FOR USE WITH VA BOOM — UNIQUE M312/M315 BUCKETS

Bucket Bite Width	mm ft/in	450 17.7"	600 1'11.6"	700 2'3.6"	900 2'11.4"	1000 3'3.4"	1100 3'7.3"	1100 3'7.3"	1200 3'11.2"	1200* 3'11.2"
ISO Bucket Capacity	m³ yd³	0.24 0.31	0.33 0.43	0.40 0.52	0.54 0.70	0.61 0.79	0.68 0.88	0.68 0.88	0.75 0.98	0.86 1.12
Bucket Tip Radius	mm ft/in	1220 4'0"	1220 4'0"	1220 4'0"	1220 4'0"	1220 4'0"	1220 4'0"	1220 4'0"	1220 4'0"	1318 4'3.9"
Number of Tips		3	3	4	5	5	6	6	6	5
Weight with Tips	kg lb	271 596	304 669	340 748	365 803	410 902	438 964	472 1038	458 1008	592 1305
Bucket Type ¹		T	T	T	X	X	X	EX	X	EX
Longest Acceptable Stick:										
Dozer Only — Up (FOW ²)	m ft/in	3.1 10'2"	3.1 10'2"	3.1 10'2"	3.1 10'2"	2.6 8'6"	2.4 7'11"	2.4 7'11"	2.1 6'11"	1.7 5'7"
Dozer Only — Down	m ft/in	3.1 10'2"	3.1 10'2"	3.1 10'2"	3.1 10'2"	3.1 10'2"	3.1 10'2"	2.6 8'6"	2.6 8'6"	2.6 8'6"
Rear Outriggers — Down	m ft/in	3.1 10'2"	3.1 10'2"	3.1 10'2"	3.1 10'2"	3.1 10'2"	3.1 10'2"	3.1 10'2"	3.1 10'2"	3.1 10'2"
2 Sets Outriggers — Down	m ft/in	3.1 10'2"	3.1 10'2"	3.1 10'2"	3.1 10'2"	3.1 10'2"	3.1 10'2"	3.1 10'2"	3.1 10'2"	3.1 10'2"
Dozer/Outriggers — Down	m ft/in	3.1 10'2"	3.1 10'2"	3.1 10'2"	3.1 10'2"	3.1 10'2"	3.1 10'2"	3.1 10'2"	3.1 10'2"	3.1 10'2"

*Requires J300 tips. All other buckets require J250 tips.

¹T = Trenching

X = Excavation

EX = Extreme Service Excavation

²Free on wheels

FOR USE WITH 1-PIECE & VA BOOMS — UNIQUE M318 BUCKETS

Bucket Bite Width	1000 mm 3'3"	1100 mm 3'7"	1200 mm 3'11"	1200 mm 3'11"
ISO Bucket Capacity	0.70 m ³ 0.92 yd³	0.80 m ³ 1.05 yd³	0.90 m ³ 1.18 yd³	0.90 m ³ 1.18 yd³
Bucket Tip Radius	1340 mm 4'5"	1340 mm 4'5"	1340 mm 4'5"	1340 mm 4'5"
Number of Tips	5	5	5	5
Weight with Tips	600 kg 1323 lb	640 kg 1411 lb	660 kg 1455 lb	713 kg 1569 lb
Bucket Type ¹	X	X	X	X
Longest Acceptable Stick:				
Dozer Only — Up (FOW ²)	2.8 m 9'2"	2.4 m 7'10"	1.8 m 5'11"	1.8 m 5'11"
Dozer Only — Down	4.0 m 13'1"	2.8 m 9'2"	2.4 m 7'10"	2.4 m 7'10"
Rear Outriggers — Down	4.0 m 13'1"	2.8 m 9'2"	2.4 m 7'10"	2.4 m 7'10"
2 Sets Outriggers — Down	4.0 m 13'1"	4.0 m 13'1"	4.0 m 13'1"	4.0 m 13'1"
Dozer/Outriggers — Down	4.0 m 13'1"	4.0 m 13'1"	4.0 m 13'1"	4.0 m 13'1"

¹T = Trenching

X = Excavation

EX = Extreme Service Excavation

²Free on wheels

FOR USE WITH 1-PIECE & VA BOOMS — UNIQUE M320 BUCKETS

Bucket Bite Width	600 mm 2'0"	750 mm 2'6"	1000 mm 3'3"	1100 mm 3'7"	1250 mm 4'1"
ISO Bucket Capacity	0.41 m ³ 0.54 yd³	0.55 m ³ 0.72 yd³	0.81 m ³ 1.06 yd³	0.90 m ³ 1.18 yd³	1.05 m ³ 1.37 yd³
Bucket Tip Radius	1423 mm 4'8"	1423 mm 4'8"	1423 mm 4'8"	1423 mm 4'8"	1423 mm 4'8"
Number of Tips	3	3	4	5	5
Weight with Tips	540 kg 1190 lb	560 kg 1230 lb	600 kg 1320 lb	685 kg 1510 lb	740 kg 1630 lb
Bucket Type	GP	GP	GP	GP	GP

Bucket Bite Width	1400 mm 4'7"	1500 mm 4'11"	1200 mm 3'11"	1250 mm 4'1"	1800 mm 5'11"
ISO Bucket Capacity	1.20 m ³ 1.57 yd³	1.35 m ³ 1.77 yd³	0.90 m ³ 1.18 yd³	1.05 m ³ 1.37 yd³	0.48 m ³ 0.63 yd³
Bucket Tip Radius	1423 mm 4'8"	1423 mm 4'8"	1340 mm 4'4"	1423 mm 4'8"	1244 mm 4'1"
Number of Tips	6	6	5	5	—
Weight with Tips	780 kg 1720 lb	810 kg 1785 lb	710 kg 1565 lb	750 kg 1655 lb	477 kg* 1050 lb*
Bucket Type	GP	GP	ES	ES	DC

Bucket Bite Width	2000 mm 6'7"	2000 mm 6'7"	2300 mm 7'7"	2000 mm 6'7"
ISO Bucket Capacity	0.58 m ³ 0.76 yd³	0.70 m ³ 0.92 yd³	0.62 m ³ 0.81 yd³	0.70 m ³ 0.92 yd³
Bucket Tip Radius	1300 mm 4'3"	1400 mm 4'7"	1244 mm 4'1"	896 mm 2'11"
Number of Tips	—	—	—	—
Weight with Tips	680 kg* 1500 lb*	720 kg* 1590 lb*	569 kg* 1255 lb*	640 kg 1410 lb
Bucket Type	DC	DC	DC	DC

*Not including adapter and cylinders.

GP = General Purpose DC = Ditch Cleaning ES = Extreme Service

EXCAVATOR SHOE SELECTION

Undercarriage life can be extended by equipping the machine properly for the application.

Many excavators work on pavement or flat, soft ground and experience few undercarriage problems. But if those same machines (usually equipped with wide track pads) were placed in severe underfoot conditions, undercarriage destruction could occur very rapidly.

The rule, used for other track-type machines — *“Whenever possible use the narrowest shoes available”* — is even more valid for excavators.

The best general purpose track shoe is the triple grouser. It has a good section modulus and offers the best compromise between traction and minimum disturbance to paved surface.

The double grouser shoe has a better section modulus and is more aggressive than the triple grouser section. Single grouser shoes are offered for maximum traction. Some users like single grousers for added mobility in hilly terrain.

The following table lists ground pressures for various width shoes (reach boom, medium stick and bucket):

Model	ShoeType	Shoe Width		Pressure	
		mm	in	kPa	psi
301.5	Double	230	9"		
	Rubber Belt	230	9"		
307B	Triple	450	18"	30.0	4.35
	Triple	600	24"	23.0	3.34
	Segment Rubber	450	18"	30.0	4.35
307B SB	Triple	450	18"	34.0	4.93
	Triple	600	24"	26.0	3.77
	Segment Rubber	450	18"	34.0	4.93
307	Triple	450	18"	32.3	4.68
	Triple	600	24"	25.3	3.67
	Apex*	600	24"	NA	NA
	Flat*	450	18"	NA	NA
	Rubber	450	18"	32.3	4.68
311B	Triple	500	20"	38.0	5.51
	Triple	600	24"	32.0	4.64
	Triple	700	28"	28.0	4.06
	Triple	770	30"	26.0	3.77
	Segment Rubber	500	20"	38.2	5.54
312B	Triple	500	20"	39.0	5.66
	Triple	600	24"	33.0	4.79
	Triple	700	28"	29.0	4.21
	Triple	770	30"	26.0	3.77
	Segment Rubber	500	20"	40.2	5.83
312B L	Triple	500	20"	38.0	5.51
	Triple	600	24"	32.0	4.64
	Triple	700	28"	28.0	4.10
	Triple	770	30"	26.0	3.77
	Triple	850	34"	24.0	3.60
	Segment Rubber	500	20"	40.2	5.83

*Custom product.

Model	ShoeType	Shoe Width		Pressure	
		mm	in	kPa	psi
315B	Triple	500	20"	48.0	6.96
	Triple	600	24"	41.0	5.95
	Triple	700	28"	35.0	5.08
315B L	Triple	500	20"	46.0	6.67
	Triple	600	24"	39.0	5.67
	Triple	700	28"	33.0	4.79
318B L	Triple	500	20"	44.0	6.39
	Triple	600	24"	42.4	6.15
	Triple	600	24"	38.0	5.54
	Triple	700	28"	36.5	5.30
	Triple	700	28"	32.0	4.69
	Triple	800	32"	32.8	4.75
318B LN	Triple	500	20"	50.0	7.25
	Triple	500	20"	49.0	7.10
	Triple	600	24"	44.0	6.39
	Triple	600	24"	42.3	6.13
	Triple	700	28"	38.0	5.54
	Triple	700	28"	36.7	5.30
320B*	Triple	600	24"	44.7	6.36
	Triple	700	28"	39.0	5.55
	Triple	800	32"	34.5	4.91
320B L*	Triple	600	24"	41.8	5.95
	Triple	700	28"	36.4	5.18
	Triple	800	32"	32.3	4.59
320B N	Triple	500	20"	55.4	7.88
	Triple	600	24"	46.7	6.64
322B	Triple	600	24"	49.8	7.22
	Triple	700	28"	43.4	6.29
	Triple	800	32"	38.3	5.55
322B L	Triple	600	24"	46.4	6.73
	Triple	700	28"	40.3	5.85
	Triple	800	32"	35.8	5.19
322B LN	Triple	600	24"	46.3	6.72
325B	Triple	600	24"	55.8	8.09
	Triple	700	28"	48.4	7.02
	Triple	800	32"	43.3	6.29
325B L	Triple	600	24"	52.9	7.67
	Triple	700	28"	45.9	6.66
	Triple	800	32"	41.1	5.96
325B LN	Triple	600	24"	52.7	7.64
330B	Triple	600	24"	67.0	9.70
	Triple	750	30"	54.0	7.80
	Triple	850	33"	49.0	7.10

*3066T Engine.

NOTE: Belgium sourced excavators have different ground pressures. See Technical Data Sheets.

Model	ShoeType	Shoe Width		Pressure	
		mm	in	kPa	psi
330B L	Triple	600	24"	62.0	9.0
	Triple	750	30"	50.0	7.3
	Triple	850	33"	45.0	6.5
330B LN	Triple	600	24"	62.0	9.0
345B	Triple	600	24"	80.3	11.6
	Triple	750	30"	65.8	9.5
	Triple	900	35"	55.7	8.1
345B L – FIX	Triple	600	24"	76.0	11.0
	Triple	750	30"	62.3	9.0
	Triple	900	35"	52.8	7.7
345B L – VG	Triple	600	24"	81.8	11.9
	Triple	750	30"	67.0	9.7
	Triple	900	35"	56.7	8.2
350	Triple	600	24"	87.6	12.7
	Triple	750	30"	70.3	10.2
	Triple	900	35"	60.0	8.7
	Double	600	24"	87.6	12.7
	Double	750	30"	71.7	10.4
350 L	Triple	600	24"	80.7	11.7
	Triple	750	30"	64.8	9.4
	Triple	900	35"	55.9	8.1
	Double	600	24"	80.7	11.7
	Double	750	30"	65.5	9.5
375	Double	610	24"	120.7	17.5
	Double	750	30"	99.3	14.4
	Double	900	35"	83.4	12.1
	Single	610	24"	122.1	17.7
375 L	Double	610	24"	113.1	16.4
	Double	750	30"	93.1	13.5
	Double	900	35"	78.6	11.4
	Single	610	24"	113.1	16.4
5130B ME	Double	650	26"	179.0	26.0
	Double	800	32"	218.0	31.6
	Double	1000	39"	145.0	21.0
5230 ME	Double	1100	43"	151.0	21.9
	Double	1300	51"	172.0	25.0
	Double	1500	59"	202.0	29.4

NOTE: Belgium sourced excavators have different ground pressures. See Technical Data Sheets.

QUICK COUPLER SYSTEMS

Quick couplers can greatly increase a machine's versatility and productivity. They make it much easier to switch attachments which can increase utilization. Quick couplers also encourage changing buckets when the application changes, rather than continue to use a less efficient bucket. Example: An application that is predominately dirt with occasional pockets or seams of rock. Without a quick coupler the owner may choose to live with a rock bucket but, rock buckets are normally smaller and heavier which reduces performance in a dirt application. A quick coupler allows the use of the rock bucket in the rock and a GP bucket in the dirt.

There are two types of quick couplers. The first is a dedicated type. A typical system substitutes hooks on the bucket for the pin-on hinges used with conventional buckets. The mating portion is pinned on the stick and bucket linkage. It slips into the hooks to secure the bucket or other attachment.

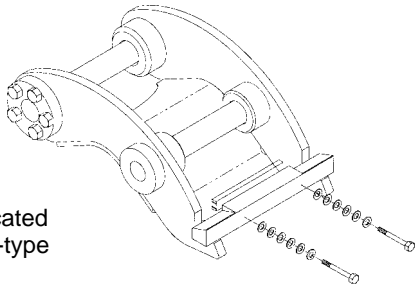

Dedicated
Hook-type

Advantages:

Bucket tip radius (distance from the bucket pivot point to the bucket tip) does not increase. Increased tip radius reduces curl and stick forces which can reduce the loadability of the bucket. The hook type coupler also does not add appreciable weight at the end of the stick. Keeping the tip radius and weight the same ensure no compromise in performance. The machine portion of the hook type coupler can be designed to allow more than one machine to use the same buckets.

Disadvantages:

The hook type system requires special buckets. Conventional pin-on buckets cannot be used. The ability to use buckets on more than one machine

requires careful application analysis. Larger machines generate forces that can destroy the wrong buckets. Smaller machines with the wrong bucket may develop loads in excess of the machine's capability. Even if the machine can handle the loads, the tip radius may be too large to allow the bucket to load properly. With the flexibility of a quick coupler comes the responsibility to make sure the bucket or other attachments are properly sized for each application.

The second type of quick coupler is the pin grabber type. This device pins on the stick and bucket linkage and grabs the bucket pins on standard pin-on buckets.

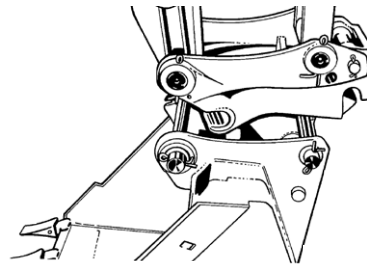

Pin Grabber

Advantages:

The advantage of the pin grabber is that it will pick up standard pin-on buckets. No need to purchase new attachments that will fit the system.

Disadvantages:

The pin grabber is mounted between the stick and the bucket which significantly increases the tip radius. This can compromise performance. It is an additional assembly between a standard bucket and stick. This means it adds more weight and reduces the excavator's payload capability.

Pin grabbers are required to mate up with existing bucket pins. Because different machines require different pin spreads, they offer very limited ability to match with buckets from other machines.

Both types of quick couplers offer two types of actuation. Mechanical ... which requires manual activity to release and engage the attachment. This process can take from one to five minutes depending on the coupler design. The other type is cab activated ... this type can usually allow an attachment change in 30 seconds or less.

EQUIPMENT FOR ...	301.5	307B		307B SB		307	
Undercarriage: Standard	●	●		●		●	
Booms: One-Piece Reach Swing	● —	● —		— ●		● —	
Sticks: Short ●	● —	mm 1670 2212	ft 5'6" 7'3"	mm 1670 2210	ft 5'6" 7'3"	mm 1665 2210	ft 5'6" 7'3"
Booms: Parallel offset	—	●		—		●	
Sticks: Short	●	mm 1670	ft 5'6"	—		mm 1665	ft 5'6"
Buckets (No. of)	12	3		3		4	
Teeth: Long (G.P.) Short (Rock)	● —	● ●		● ●		● ●	
Side Cutters: One-Piece Blade	—	●		●		●	
Track Shoes:	Double Grouser 230 mm (9") Rubber Belt 230 mm (9")	Triple Grouser 450, 600 mm (18", 24") Rubber Pads 450 mm (18")		Triple Grouser 450, 600 mm (18", 24") Rubber Pads 450 mm (18")		Triple Grouser 450, 600 mm (18", 24") Rubber Pads 450 mm (18")	

NOTE: Number of buckets includes Gen. Purpose, Trenching and Rock. Other types of buckets have not been included.
 All attachments may not be available in all sales areas.

EQUIPMENT FOR ...	311B		312B 312B L		315B 315B L		318B L 318B LN	
Undercarriage:								
Standard	●		●		●		—	
Long (L)	—		●		●		●	
Narrow (N)	—		—		—		●	
Booms:								
One-Piece Reach	●		●		●		●	
Sticks:	mm	ft	mm	ft	mm	ft	mm	ft
Short	1950	6'5"	2100	6'11"	1850	6'1"	1800	5'11"
●	2250	7'5"	2500	8'2"	2250	7'5"	2250	7'5"
●	2800	9'2"	3000	9'10"	2600	8'6"	2700	8'10"
Long	—		—		3100	10'2"	3200	10'6"
Booms:								
One-Piece Mass	—		—		—		—	
Two-Piece VA	—		●		●		●	
Parallel offset	—		—		—		—	
Sticks:			mm	ft	mm	ft		
Short	—		2100	6'11"	1850	6'1"	—	
●	—		2500	8'2"	2250	7'5"	—	
●	—		3000	9'10"	2600	8'6"	—	
Long	—		—		3100	10'2"	—	
Bucket Family	—		—		—		B	
Buckets (No. of)	5		68		55		40	
Teeth:								
Abrasion	●		●		●		●	
Long (G.P.)	●		●		●		●	
Short (Rock)	●		●		●		●	
Penetration	●		●		●		●	
Wide (Spade)	●		●		●		●	
Sharp	●		●		●		●	
Side Cutters:								
One-Piece Blade	●		●		●		●	
Track Shoes:								
	Triple Grouser 500, 600, 700, 770 mm (20", 24", 28", 30")		Triple Grouser 500, 600, 700, 770, 850, 900, 1400 mm (20", 24", 28", 30", 34", 36", 56")		Triple Grouser 500, 600, 700, 900 mm (20", 24", 28", 36")		Triple Grouser 600, 700, 800, 900 mm (24", 28", 32", 36")	
	Rubber Pads 500 mm (20")		Rubber Pads 500 mm (20")		Rubber Pads 500, 600 mm (20", 24")		Rubber Pads 500, 600 mm (20", 24")	

NOTE: Number of buckets includes Gen. Purpose, Trenching and Rock. Other types of buckets have not been included.
All attachments may not be available in all sales areas.

EQUIPMENT FOR ...	320B 320B L 320B LN	322B 322B L 322B LN	325B 325B L 325B LN	330B 330B L 330B LN	345B 345B L
Undercarriage:					
Standard	●	●	●	●	●
Long (L)	●	●	●	●	●
Narrow (N)	●	—	—	—	—
Long Narrow (LN)*	—	●*	●*	●*	—
Booms:					
One-Piece Reach	●	●	●	●	●
Sticks:	mm ft	mm ft	mm ft	mm ft	mm ft
Short	1900 6'3"	—	2000 6'7"	2150 7'1"	—
●	2500 8'2"	2500 8'2"	2650 8'8"	2800 9'2"	2900 9'6"
●	2920 9'7"	2950 9'8"	3200 10'6"	3300 10'10"	3350 11'0"
●	—	3600 11'10"	4200 13'9"	3900 12'10"	3900 12'10"
Long	3860 12'8"	—	—	—	—
Booms:					
One-Piece Mass	●	●	●	●	●
Two-Piece VA	●	●	—	—	—
Sticks:	mm ft	mm ft	mm ft	mm ft	mm ft
Short	1900 6'3"	2000 6'7"	2000 6'7"	2150 7'1"	2500 8'2"
●	2400 7'10"	2500 8'2"	2500 8'2"	2550 8'4"	3000 9'10"
●	2920 9'7"	—	3200 10'6"	—	—
Bucket Family	B, C	B, S, D	B, C, D	D, E	F, G, T, U
Buckets (No. of)	19	24	24	17	15
Teeth:					
Abrasion	●	●	●	●	●
Long (G.P.)	●	●	●	●	●
Short (Rock)	●	●	●	●	●
Penetration	●	●	●	●	●
Wide (Spade)	●	●	●	●	●
Sharp	●	●	●	●	●
Side Cutters:					
One-Piece Blade	●	●	●	●	●
Track Shoes:	Triple Grouser 500, 600, 700 800 mm (20", 24", 28", 30") Apex 800 mm (32")	Triple Grouser 600, 700, 800 mm (24", 28", 32")	Triple Grouser 600, 700, 800 mm (24", 28", 32") Double Grouser 600, 700 mm (24", 28")	Triple Grouser 600, 750, 850 mm (24", 30", 34") Double Grouser 700 mm (28")	Triple Grouser 600, 750, 900 mm (24", 30", 35") Double Grouser 600, 750 mm (24", 30")
Quick Coupler	—	*	*	*	*

* All attachments may not be available in all sales areas.

NOTE: Number of buckets includes Gen. Purpose, Trenching and Rock. Other types of buckets have not been included.

Excavators

Summary of Major Attachments

● 350 ● 375 ● 5130B ME ● 5230 ME

EQUIPMENT FOR ...	350 350 L		375 375 L		5130B ME	5230 ME
Undercarriage:						
Standard	●		●		●	●
Long (L)	●		●		—	—
Booms:						
One-Piece Reach	●		●		N/A	N/A
One-Piece GP	—		●		N/A	N/A
Sticks:	mm	ft	mm	ft		
Short	3100	10'2"	2900*	9'6"	N/A	N/A
●	3600	11'10"	3400*	11'2"	N/A	N/A
●	4050	13'3"	4400	14'5"	N/A	N/A
●	4800	15'9"	5500	18'1"	N/A	N/A
Booms:						
One-Piece Mass	●		●		●	●
Sticks:	mm	ft	mm	ft		
Short	2400	7'10"	2900	9'6"	N/A	N/A
●	2950	9'8"	3400	11'2"	N/A	N/A
Long	3700	12'2"	4100	13'5"	N/A	N/A
Bucket Family	F, G		H, J		—	—
Sticks	—		—		ME & LR	ME & LR
Buckets (No. of)	24		23		5	3
Teeth:						
Abrasion	●		●		●	—
Long (G.P.)	●		●		●	●
Short (Rock)	●		●		●	●
Penetration	●		●		●	—
Wide (Spade)	●		●		—	—
Sharp	●		●		—	—
Side Cutters:						
One-Piece Blade	●		●		●	●
Track Shoes:	Triple Grouser 600, 750, 900 mm (24", 30", 36") Double Grouser 600, 750 mm (24", 30")		Double Grouser 610, 750, 900 mm (24", 30", 36") Single Grouser 610 mm (24")		Double Grouser 650, 800, 1000 mm (26", 32", 39")	Double Grouser 1100, 1300, 1500 mm (43", 52", 60")

* All attachments may not be available in all sales areas.

NOTE: Number of buckets includes Gen. Purpose, Trenching and Rock. Other types of buckets have not been included.

EQUIPMENT FOR ...	M312		M315		M318		M320	
Undercarriage:								
Wheeled	●		●		●		●	
Booms:								
One-piece	●		●		●		●	
VA	●		●		●		●	
Backhoe Sticks:	mm	ft	mm	ft	mm	ft	mm	ft
Short	1600	5'3"	1700	5'7"	1800	5'11"	1900	6'3"
Medium	2000	6'6"	2100	6'9"	2400	7'9"	2500	8'2"
Medium Long	2300	7'5"	2400	7'9"	—		—	
Long	2600	8'5"	2600	8'5"	2800	9'2"	2900	9'6"
Extra Long	3000	9'9"	3100	10'1"	4000	13'1"	4200	13'9"
Material Handling Stick	—		—		3200	10'6"	—	
Buckets (No. of)	13		13		8		14	
Teeth:								
Abrasion	●		●		●		●	
Long (G.P.)	●		●		●		●	
Short (Rock)	●		●		●		●	
Penetration	●		●		●		●	
Wide	—		—		—		●	
Sharp	—		—		—		●	
Side Cutters:								
One-Piece Blade	●		●		●		—	
Tires:								
	Tires: Duals 10.00-20 11.00-20		Tires: Duals 10.00-20 11.00-20		Tires: Duals 10.00-20 11.00-20		Tires: Duals 11.00-20 10.00-20 Solid	
	Singles 18-19.5		Singles 18-19.5 18R-22.5XF		Singles 18-19.5 18-22.5		Singles 18R-19.5XF 18R-22.5XF	

NOTE: Number of buckets shown includes general purpose, rock and trenching. Not included are ditch cleaning, ditch grading and trapezoidal ditching.

Work Tools	M312	M315	M318	M320
Clamshell*	X	X	X	
Ditch Cleaning Bucket	X	X	X	X
Grapples*	X	X	X	
Hammer Installation Kit	X	X	X	

*With hydraulic rotator.

Work Tools	345B/		330B	325B	322B	318B L/		311B,		307B
	375	350				318B LN	315B	312B L		
Quick Coupler		X	X	X	X	X	X	X	X	X
Ditch Cleaning		X	X	X	X	X	X	X	X	X
General Purpose	X	X	X	X	X	X	X	X	X	X
Rock	X	X	X	X	X	X	X	X	X	X
Tilt Bucket			X	X	X	X	X	X	X	X
Thumb	X	X	X	X	X	X	X	X	X	X
Construction Grapple		X	X	X	X	X	X	X	X	
Medium Grapple		X	X	X	X	X	X	X	X	
Trash Grapple		X	X	X	X	X	X	X	X	
Hydraulic Hammer	X	X	X	X	X	X	X	X	X	X
Vibratory Plate Compactor				X	X	X	X	X	X	X
Shear	X	X	X	X	X	X				
Crusher		X	X	X	X	X				
Pulverizer	X	X	X	X	X	X				
Rock Drill						X		X		

NOTE: Other attachments available upon request. Contact Caterpillar Attachment Products and Services.

CYCLE TIME ESTIMATING CHARTS

The digging cycle of the excavator is composed of four segments:

1. Load Bucket
2. Swing Loaded
3. Dump Bucket
4. Swing Empty

Total excavator cycle time is dependent on machine size (small machines can cycle faster than large machines) and job conditions. With excellent job conditions the excavator can cycle fast. As job conditions become more severe (tougher digging, deeper trench, more obstacles, etc.), the excavator slows down accordingly. As the soil gets harder to dig, it takes longer to fill the bucket. As the trench gets deeper and the spoil pile larger, the bucket has to travel farther and the upper structure has to swing farther on each digging cycle.

Spoil pile or truck location also affects cycle time. If a truck is located on the floor of the excavation beside material being moved, 10 to 17 second cycles are practical. The other extreme would be a truck or spoil pile located above the excavator 180° from the excavation.

In sewer construction work the operator may not be able to work at full speed because he has to dig around existing utilities, load the bucket inside a trench shield, or avoid people working in the area.

The Cycle Time Estimating Chart outlines the range of total cycle time that can be expected as job conditions range from excellent to severe. Many variables affect how fast the excavator is able to work. The chart defines the range of cycle times frequently experienced with a machine and provides a guide to what is an “easy” or a “hard” job. The estimator can then evaluate the conditions of his job and use the Cycle Time Estimating Chart to select the appropriate working range. A practical method of further calibrating the Cycle Time Estimating Chart is to observe excavators working in the field and correlate measured cycle times to job conditions, operator ability, etc.

The following table breaks down what experience has shown to be typical Caterpillar excavator cycle times with

- no obstruction in the right of way
- above average job conditions
- an operator of average ability and
- 60°-90° swing angle.

These times would decrease as job conditions or operator ability improved and would get slower as conditions become less favorable.

CYCLE TIME -vs- JOB CONDITION DESCRIPTION

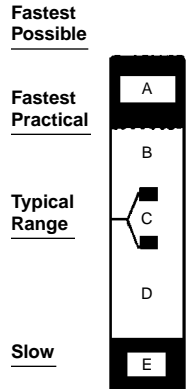

- KEY**
- A — Excellent
 - B — Above Average
 - C — Average
 - D — Below Average
 - E — Severe

- Easy digging (unpacked earth, sand gravel, ditch cleaning, etc.). Digging to less than 40% of machine’s maximum depth capability. Swing angle less than 30°. Dump onto spoil pile or truck in excavation. No obstructions. Good operator.
- Medium digging (packed earth, tough dry clay, soil with less than 25% rock content). Depth to 50% of machine’s maximum capability. Swing angle to 60°. Large dump target. Few obstructions.
- Medium to hard digging (hard packed soil with up to 50% rock content). Depth to 70% of machine’s maximum capability. Swing angle to 90°. Loading trucks with truck spotted close to excavator.
- Hard digging (shot rock or tough soil with up to 75% rock content). Depth to 90% of machine’s maximum capability. Swing angle to 120°. Shored trench. Small dump target. Working over pipe crew.
- Toughest digging (sandstone, caliche, shale, certain limestones, hard frost). Over 90% of machine’s maximum depth capability. Swing over 120°. Loading bucket in man box. Dump into small target requiring maximum excavator reach. People and obstructions in the work area.

Cycle Time Estimating Chart

Model	307	311B	312B, 312B L	315B, 315B L	318B L*, 318B LN	320B	322B	325B	330B	345B*	350	375	5130 ME	5230 ME
Bucket Size L (yd ³)	280 0.37	450 0.59	520 0.68	520 0.68		800 1.05	1000 1.31	1100 1.44	1400 1.83		1900 2.5	2800 3.66	10 m ³ 13	15.5 m ³ 20.3
Soil Type	← Packed Earth →					← Hard Clay →								
Digging Depth (m) (ft)	1.5 5	1.5 5	1.8 6	3.0 10		2.3 8	3.2 10	3.2 10	3.4 11		4.2 14	5.2 17	4.0 13	5.0 16
Load Bucket (min)	0.08	0.07	0.07	0.10		0.09	0.09	0.09	0.09		0.10	0.11	0.12	0.12
Swing Loaded (min)	0.05	0.06	0.06	0.04		0.06	0.06	0.06	0.07		0.09	0.10	0.13	0.14
Dump Bucket (min)	0.03	0.03	0.03	0.02		0.03	0.04	0.04	0.04		0.04	0.04	0.04	0.04
Swing Empty (min)	0.06	0.05	0.05	0.05		0.05	0.06	0.06	0.07		0.07	0.09	0.13	0.14
Total Cycle Time (min)	0.22	0.21	0.21	0.21		0.23	0.25	0.25	0.27		0.30	0.34	0.42	0.44

*Information not available at time of printing.

CYCLE TIME ESTIMATING CHART															
CYCLE TIME	MACHINE SIZE CLASS														CYCLE TIME
	307	311B	312B	315B	318B L*	320B	322B	325B	330B	345B*	350	375	5130B ME	5230 ME	
10 SEC.															0.17 min.
15															0.25 min.
20 SEC.															0.33 min.
25															0.42 min.
30 SEC.															0.50 min.
35															0.58 min.
40 SEC.															0.67 min.
45															0.75 min.
50 SEC.															0.83 min.
55															0.92 min.
60 SEC.															1.0 min.

*Information not available at time of printing.

Caterpillar 300 Series Mass Excavation booms and buckets coupled with the proper stick will help you move material faster and more efficiently in production excavation and loading applications. With the largest bucket, shortest stick and long undercarriage your excavator can often do the work of a larger machine. A longer stick and standard undercarriage make it ideal for loading on-highway trucks and general construction jobs.

MAXIMIZING PRODUCTION WITH A MASS EXCAVATOR

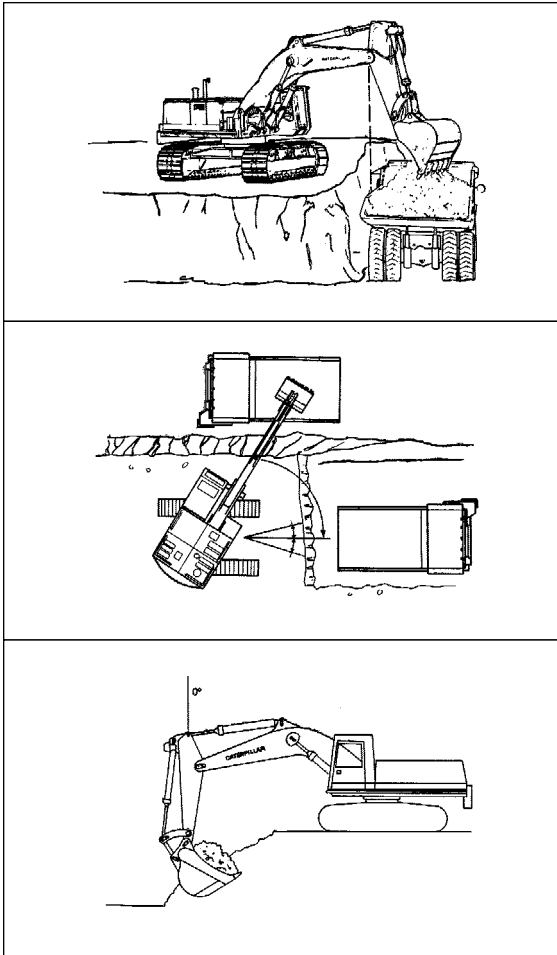

Ideal Bench Height and Truck Distance — For stable or consolidated materials, bench height should be about equal to stick length. For unstable materials it should be less. The most useful truck position is when the inside truck body rail is below the boomstick hinge pin.

Optimum Work Zone and Swing Angle — For maximum production, the work zone should be limited to 15° either side of machine center or about equal to undercarriage width. Trucks should be positioned as close as possible to machine centerline. Two alternatives shown here.

Best Distance from the Edge — The machine should be positioned so that the stick is vertical when the bucket reaches full load. If the unit is farther back, breakout force is reduced. If it is closer to the edge, undercutting may occur and time is wasted bringing the stick back out. Also, the operator should begin boom-up when the bucket is 75% of the way through the curl cycle. This should be as the stick nears the vertical position.

This example reflects the ideal situation. Not all points are usable on each job, but incorporation of as many of these points as possible will positively affect production.

EARTHMOVING PRODUCTION

As with any other piece of material handling equipment, excavator earthmoving production is dependent on average bucket payload, average cycle time and job efficiency. If an estimator can accurately predict excavator cycle time and bucket payload, a machine's earthmoving production can be derived from the following formula.

$$m^3 (yd^3)/60 \text{ min hr} = \text{Cycles}/60 \text{ min hr} \times \text{Avg. Bucket Payload in } m^3 (yd^3)$$

$$\frac{m^3 (yd^3)/60 \text{ min hr}}{60 \text{ min/hr}} = \frac{\text{Cycles}}{\text{Cycle Time} - \text{min}} \times \text{Avg. Bucket Payload in } m^3 (yd^3)$$

$$\text{Avg. Bucket Payload} = \frac{\text{Heaped Bucket Capacity} \times \text{Bucket Fill Factor}}{\text{Job Efficiency Factor}}$$

$$\text{Actual } m^3 (yd^3)/hr = \frac{m^3 (yd^3)/60 \text{ min hr} \times \text{Job Efficiency Factor}}{\text{Job Efficiency Factor}}$$

The Production Estimating Tables (next page) will provide theoretical earthmoving production in cubic meters (yards) per hour if bucket size and cycle time can be estimated. The use of an average cycle time allows adjusting the estimated production for specific job sites and applications. For instance, estimating truck loading applications should include truck exchange times which extends the average cycle time and reduces production potential. The values in the table are based on a 60 minute work hour or 100% efficiency (a condition that is never achieved in reality). The estimator should apply a job efficiency factor to the figures in the table based on his judgment or knowledge of actual job conditions.

Areas outlined on the Production Estimating Table define the work ranges of excavators in the size classes of Caterpillar 307 through 5230 ME Excavators. The upper limit on each area corresponds to the "fastest practical" cycle time for the machines. The width of each area corresponds to the range of bucket payload sizes the machine can handle. An unshaded box has been provided in each machine area to provide a guide indicating that the upper limit of earthmoving production is being approached. When working beyond the values in the white area, the estimator should be certain that excellent job conditions will be encountered (easy digging, shallow trench, good operator, etc.).

The Production Estimating Table can also serve as a guide when selecting the proper size machine to do a job, as is shown in the following example.

Example problem (Metric)

Contractor has a job to move 15 300 Bm³ (19 100 Lm³ considering 25% swell factor) of wet sandy loam material in rear dump on-highway trucks which will be loaded by an excavator. Average face depth will be 2.4 m with 60-90 degree average swing angle. Ten days are available to do the work. Contractor plans to work 10 hrs/day and estimates a 50 min. work hour (83% job efficiency). He has two excavators that could be made available to do the work — a 320 with 1.0 m³ bucket or a 330 with 1.9 m³ bucket. Experience has shown that either machine can get its rated capacity in the sandy loam soil. Could this job be done with either machine or will the 330 have to be used?

Solution: The excavator must produce 1900 Lm³/Day (19 100 Lm³ ÷ 10 Days) which means the required average hourly rate will be 190 Lm³/60 Min. Hr. (1900 Lm³/Day ÷ 10 hrs/day). Further considering the 83% job efficiency, the excavator's capability will have to be 230 Lm³/50 min hr.

The production estimating table shows that the 320 with a 1.0 m³ bucket would have to achieve a 17.1 sec. average cycle time to produce the required 190 Lm³/60 min. hr. With job efficiency applied a 15.0 second average cycle time is required to produce the 230 Lm³/50 min. hr. The 330 with a 1.9 m³ bucket could obtain the same 60 min. hr. production level with a 35 second average cycle, or 30 second cycles to meet the 50 min. hr. production requirement. The cycle times estimating chart shows that the 320 would be working near its maximum capability to meet the production requirement, whereas, the 330 could handle the job easily. This information can then be weighed against what else is known about the job (reach requirements, job conditions, operator ability, etc.) to decide whether or not the larger machine is needed.

Example problem (English)

Substitute these English values in the preceding problem:

Job — 20,000 BCY (25,000 LCY considering 25% swell).

Average face depth — 8-12 ft

320 L with 1.25 yd³ bucket or 330 with 2.5 yd³ bucket.

Solution: The excavator must produce 2500 LCY/Day, which means the required average hourly rate will be 250 LCY/60 min hr. Further considering the 83% job efficiency the excavator's capability will have to be 300 LCY/50 min hr.

The same concluding comments regarding the Production Estimating Table apply here as in the Metric example.

Cubic Meters per 60 Minute Hour*

ESTIMATED CYCLE TIMES		ESTIMATED BUCKET PAYLOAD** — LOOSE CUBIC METERS																				ESTIMATED CYCLE TIMES	
Cycle Time		0.2	0.3	0.5	0.7	0.9	1.1	1.3	1.5	1.7	1.9	2.1	2.3	2.5	2.7	2.9	3.1	3.3	3.5	4.0	Cycles Per Min.	Cycles Per Hr.	
Seconds	Min.																						
10.0	0.17																					6.0	360
11.0	0.18																					5.5	330
12.0	0.20	60	90	150	210	270																5.0	300
13.3	0.22	54	81	135	189	243	297	351	405	459	513	567	621	675	729	783	837	891	945	1080	4.5	270	
15.0	0.25	48	72	120	168	216	264	312	360	408	456	504	552	600	648	696	744	792	840	960	4.0	240	
17.1	0.29	42	63	105	147	189	231	273	315	357	399	441	483	525	567	609	651	693	735	840	3.5	210	
20.0	0.33	36	54	90	126	162	198	234	270	306	342	378	414	450	486	522	558	544	630	720	3.0	180	
24.0	0.40	30	45	75	105	135	165	195	225	255	285	315	345	375	405	435	465	495	525	600	2.5	150	
30.0	0.50	24	36	60	84	108	132	156	180	204	228	252	276	300	324	348	372	396	420	480	2.0	120	
35.0	0.58	20	31	51	71	92	112	133	153	173	194	214	235	255	275	296	316	337	357	408	1.7	102	
40.0	0.67					81	99	177	135	153	171	189	207	225	243	261	279	297	315	360	1.5	90	
45.0	0.75									133	148	164	179	195	211	226	242	257	273	312	1.3	78	
50.0	0.83																				1.2	72	

Cubic Yards per 60 Minute Hour*

ESTIMATED CYCLE TIMES		ESTIMATED BUCKET PAYLOAD** — LOOSE CUBIC YARDS																				ESTIMATED CYCLE TIMES	
Cycle Time		0.25	0.50	0.75	1.00	1.25	1.50	1.75	2.00	2.25	2.50	2.75	3.00	3.25	3.50	3.75	4.00	4.50	5.00	5.25	Cycles Per Min.	Cycles Per Hr.	
Seconds	Min.																						
10.0	0.17																					6.0	360
11.0	0.18																					5.5	330
12.0	0.20	75	150	225	300	375																5.0	300
13.3	0.22	67	135	202	270	337	404	472	540	607	675	742	810	877	945	1012	1080	1215	1350	1417	4.5	270	
15.0	0.25	60	120	180	240	300	360	420	480	540	600	660	720	780	840	900	960	1080	1200	1260	4.0	240	
17.1	0.29	52	105	157	210	262	315	367	420	472	525	577	630	682	735	787	840	945	1050	1102	3.5	210	
20.0	0.33	45	90	135	180	225	270	315	360	405	450	495	540	585	630	675	720	810	900	945	3.0	180	
24.0	0.40	37	75	112	150	187	225	262	300	337	375	412	450	487	525	562	600	675	750	787	2.5	150	
30.0	0.50	30	60	90	120	150	180	210	240	270	300	330	360	390	420	450	480	510	600	630	2.0	120	
35.0	0.58	36	51	77	102	128	154	180	205	231	256	282	08	333	360	385	410	462	513	535	1.7	102	
40.0	0.67					112	135	157	180	202	225	247	270	292	315	337	360	405	450	472	1.5	90	
45.0	0.75									180	200	220	240	260	280	300	320	360	400	409	1.3	78	
50.0	0.83																				1.2	72	

Job Efficiency Estimator

Work Time/Hour	Efficiency
60 Min	100%
55	91%
50	83%
45	75%
40	67%

*Actual hourly production = (60 min. hr. production) × (Job Efficiency Factor)
 **Estimated Bucket Payload = (Amount of Material in the Bucket)
 = (Heaped Bucket Capacity) × (Bucket Fill Factor)
 Unshaded area indicates average production.

Cubic Meters/Yards per 60 Minute Hour*

ESTIMATED CYCLE TIMES		ESTIMATED BUCKET PAYLOAD** — LOOSE CUBIC METERS/YARDS											ESTIMATED CYCLE TIMES	
Cycle Time		5.0	6.0	7.0	8.0	9.0	10.0	11.0	12.0	13.0	14.0	15.0	Cycles Per Min.	Cycles Per Hr.
Seconds	Min.													
15.0	0.25	1200	1440	1680	1920	2160	2400	2640	2880	3120	3360	3600	4.0	240
17.1	0.29	1050	1260	1470	1680	1890	2100	2310	2520	2730	2940	3150	3.5	210
20.0	0.33	900	1080	1260	1440	1620	1800	1980	2160	2340	2520	2700	3.0	180
24.0	0.40	750	900	1050	1200	1350	1500	1650	1800	1950	2100	2250	2.5	150
30.0	0.50	600	720	840	960	1080	1200	1320	1440	1560	1680	1800	2.0	120
35.0	0.58	510	612	714	816	918	1020	1122	1224	1326	1428	1530	1.7	102
40.0	0.67	450	540	630	720	810	900	990	1080	1170	1260	1350	1.5	90
45.0	0.75	390	468	546	624	702	780	858	936	1014	1092	1170	1.3	78
50.0	0.83	360	432	504	576	648	720	792	864	936	1008	1080	1.2	72
55.0	0.92	330	396	462	528	594	660	726	792	858	924	990	1.1	66
60.0	1.00	300	360	420	480	540	600	660	720	780	840	900	1.0	60

4

Cubic Meters/Yards per 60 Minute Hour*

ESTIMATED CYCLE TIMES		ESTIMATED BUCKET PAYLOAD** — LOOSE CUBIC METERS/YARDS										ESTIMATED CYCLE TIMES	
Cycle Time		16.0	17.0	18.0	19.0	20.0	21.0	22.0	23.0	24.0	25.0	Cycles Per Min.	Cycles Per Hr.
Seconds	Min.												
15.0	0.25	3840	4080	4320	4560	4800	5040	5280	5520	5760	6000	4.0	240
17.1	0.29	3360	3570	3780	3990	4200	4410	4620	4830	5040	5250	3.5	210
20.0	0.33	2880	3060	3240	3420	3600	3780	3960	4140	4320	4500	3.0	180
24.0	0.40	2400	2550	2700	2850	3000	3150	3300	3450	3600	3750	2.5	150
30.0	0.50	1920	2040	2160	2280	2400	2520	2640	2760	2880	3000	2.0	120
35.0	0.58	1632	1734	1836	1938	2040	2142	2244	2346	2448	2550	1.7	102
40.0	0.67	1440	1530	1620	1710	1800	1890	1980	2070	2160	2250	1.5	90
45.0	0.75	1248	1326	1404	1482	1560	1638	1716	1794	1872	1950	1.3	78
50.0	0.83	1152	1224	1296	1368	1440	1512	1584	1656	1728	1800	1.2	72
55.0	0.92	1056	1122	1188	1254	1320	1386	1452	1518	1584	1650	1.1	66
60.0	1.00	960	1020	1080	1140	1200	1260	1320	1380	1440	1500	1.0	60

Job Efficiency Estimator

Work Time/Hour	Efficiency
60 Min	100%
55	91%
50	83%
45	75%
40	67%

*Actual hourly production = (60 min. hr. production) × (Job Efficiency Factor)

**Estimated Bucket Payload = (Amount of Material in the Bucket)

= (Heaped Bucket Capacity) × (Bucket Fill Factor)

NOTE: For estimating truck loading production include approximately 0.7 minutes for truck exchange time.

EXCAVATOR TRENCHING PRODUCTION

When an excavator is used for trenching applications, a meaningful expression of work produced is the machine's trenching rate expressed in meters or lineal feet per hour or per day. Trenching rate depends on the earthmoving production of the excavator being used and the size of the trench being excavated. Earthmoving production converts to trenching production as follows:

$$\text{Lineal Meters of Trench per Hour} = \frac{\text{Cubic Meters Excavated per Hour}}{\text{Cubic Meters per Lineal Meter of Trench}}$$

$$\text{Lineal Meters of Trench per day} = (\text{Lineal Meters per Hour}) \times (\text{Trenching Hours per Day})$$

$$\text{Lineal Feet of Trench per Hour} = \frac{\text{Yd}^3 \text{ Excavated Per Hour}}{\text{Yd}^3 \text{ Per Lineal Foot of Trench}}$$

$$\text{Lineal Feet of Trench Per Day} = (\text{Lineal Ft Per Hour}) \times (\text{Trenching Hours Per Day})$$

For machines that work in trenching applications where they dig all of the time, the *Trenching Conversion Chart* provides easy conversion from m³ (yd³) per hour to m (lineal feet) per hour, if the excavating rate m³/hr (yd³/hr) and trench volume m³/m (yd³/ft) are known. The following examples demonstrate how the Trenching Conversion Chart can be used.

Example problem (Metric)

Contractor estimates that the 325 Excavator will produce 200 Lm³/hour. Trench survey shows that the trench contains 2.5 Lm³/meter. What trenching rate will the 325 produce?

Solution: Enter the horizontal axis of the Trenching Conversion Chart at 200 m³/Hour and move up to the 2.5 m³/m diagonal line. Then move left to the vertical axis of chart and read answer of 80 m/hour.

Example problem 2 (Metric)

Contractor knows he must produce 1000 meters of trench in every 10 hour work day. Survey shows that trench contains 1.5 Bm³ per lineal meter and soil swell factor is estimated at 30%. How much earthmoving production will the excavator have to provide in order to get the job done on time assuming a 50 min work hour? What Caterpillar excavator will provide needed production at 6 meter maximum depth in sandy loam soil?

Solution: Determine trenching requirement 1000 meters in 10 hrs = 100 m/h. Convert Bm³ to Lm³ (excavator handles Lm³) 1.5 Bm³/m × 1.30 = 2.0 Lm³/m. Enter vertical axis of trenching conversion chart at m/h and travel horizontally to diagonal line representing 2.0 m³/m. Next move down to horizontal axis and read answer to 200 Lm³/50 min hr. Convert 200 Lm³/50 min hr to Lm³/60 min hr = 200 = 241 Lm³/60 min hr.

Production estimating tables in this section show that 241 Lm³/60 min hr is within the capability of a 325 Excavator. Job should then be checked for reach and lifting requirements to make sure that the 325 could handle these aspects of the work.

Example problem (English)

Contractor estimates that a 325 Excavator will produce 250 LCY/Hour. Trench survey shows that the trench contains 2.5 LCY/Foot. What trenching rate will the 325 produce?

Solution: Enter the horizontal axis of the Trenching Conversion Chart at 250 yd³/hr. Then move to the vertical axis of chart and read answer of 100 ft/hr.

The Trenching Conversion Chart can also be used to determine the required excavating rate if the contractor can define his trenching production requirement and the trench volume per lineal foot.



Example problem 2 (English)

Contractor knows he must produce 1000 ft of trench in every 10 hr work day. Survey shows that trench contains 1.6 BCY per lineal ft and soil swell factor is estimated at 25%. How much earthmoving production will excavator have to provide in order to get the job done on time assuming 50 min work hour? What Caterpillar model will provide needed production at 8 ft depth in sandy loam soil?

Solution: Determine trenching requirement —
1000 ft in 10 Hrs. = 100 ft/hr
Convert BCY to LCY — $1.6 \text{ BCY/ft} \times 1.25 = 2.0 \text{ LCY/ft}$

Enter vertical axis of trenching conversion chart at 100 ft/hr and travel over to diagonal line representing 2.0 yd³/ft. Next move down to horizontal axis and read answer of 200 LCY/50 min hr.

Convert 200 LCY/50 min hr to LCY/60 min hr = $\frac{200}{0.83} = 241 \text{ LCY/60 min hr}$

Production estimating tables in this section show that 241 LCY/60 min. hr. is within capability of a 325 Excavator. Job should then be checked for reach and lifting requirements to make sure that the 325 could handle these aspects of the work.



TRENCHING CONVERSION CHART — CUBIC METERS (yd³) PER HOUR TO METER (ft) PER HOUR

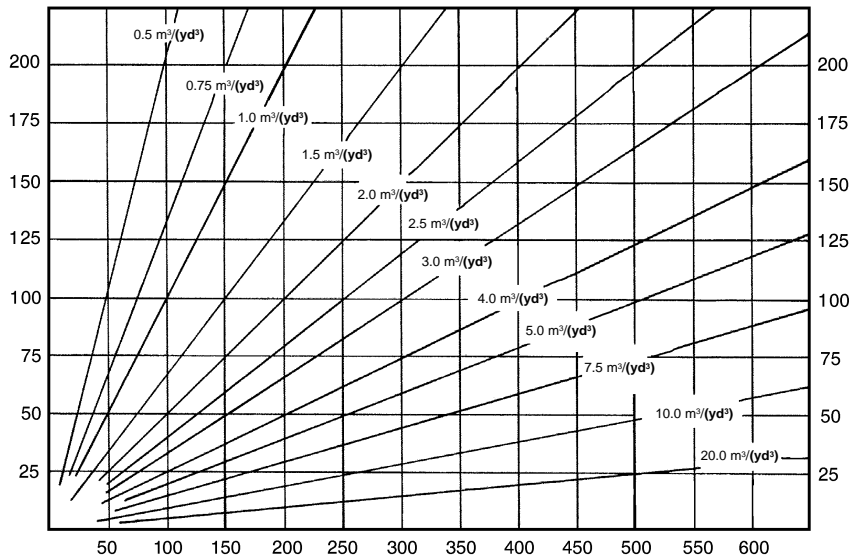

m (ft.) = m³/(yd³) Hr.
Hr. = m³/(yd³) m (ft.)

Values in m³/m or yd³/ft

If excavating rate has been calculated in Bm³/h use Bm³/m for Trench Volume/m.
" " " " " " " " Lm³/h use Lm³/m for Trench Volume/m.
" " " " " " " " BCY/Hr use BCY/ft for Trench Volume/ft.
" " " " " " " " LCY/Hr use LCY/ft for Trench Volume/ft.

Estimating Bucket Size

In addition to the trenching calculations on the previous pages, an alternative method of figuring trenching production is the nomograph. Shown on the following pages, this particular nomograph can be used for estimating bucket size when given trench dimensions and linear production rate. The nomograph is quicker and easier than the preceding example because it does not require as many calculations, yet the accuracy is about the same within the normal limits of input data.

Be careful when entering and reading data from the nomographs because some scales increase from bottom to top, while others are the reverse. Do not be overly concerned with the precision as affected by pencil line width or reading to the hundredth of a m³ (yd³). Remember that bucket fill factor, material density and cycle time are at best close estimates.

Example problem:

A sewer contractor owns a 325 with 2 piece boom and short stick. He wants to bid a contract for a 3.1 m (10') deep trench which measures 1.8 m (6') at the top and 1.2 m (4') at the bottom. He must dig 9 m/hr (30 ft/hr) to finish on time. The material is sand and gravel with a load factor of 0.90 and 100% bucket fill factor. He works 54 minutes per hour, half the time digging and half setting pipe. Cycle time is estimated at 23 seconds which includes a 90° swing angle.

- 1) Enter trench depth 3.1 m (10') on scale A and average trench width 1.5 m (5') on scale B.
- 2) Connect A and B and extend to scale C for bank volume per m (ft).
- 3) Enter estimated load factor (0.90) on scale D.
- 4) Connect C & D and extend to scale E for loose volume per m (ft).

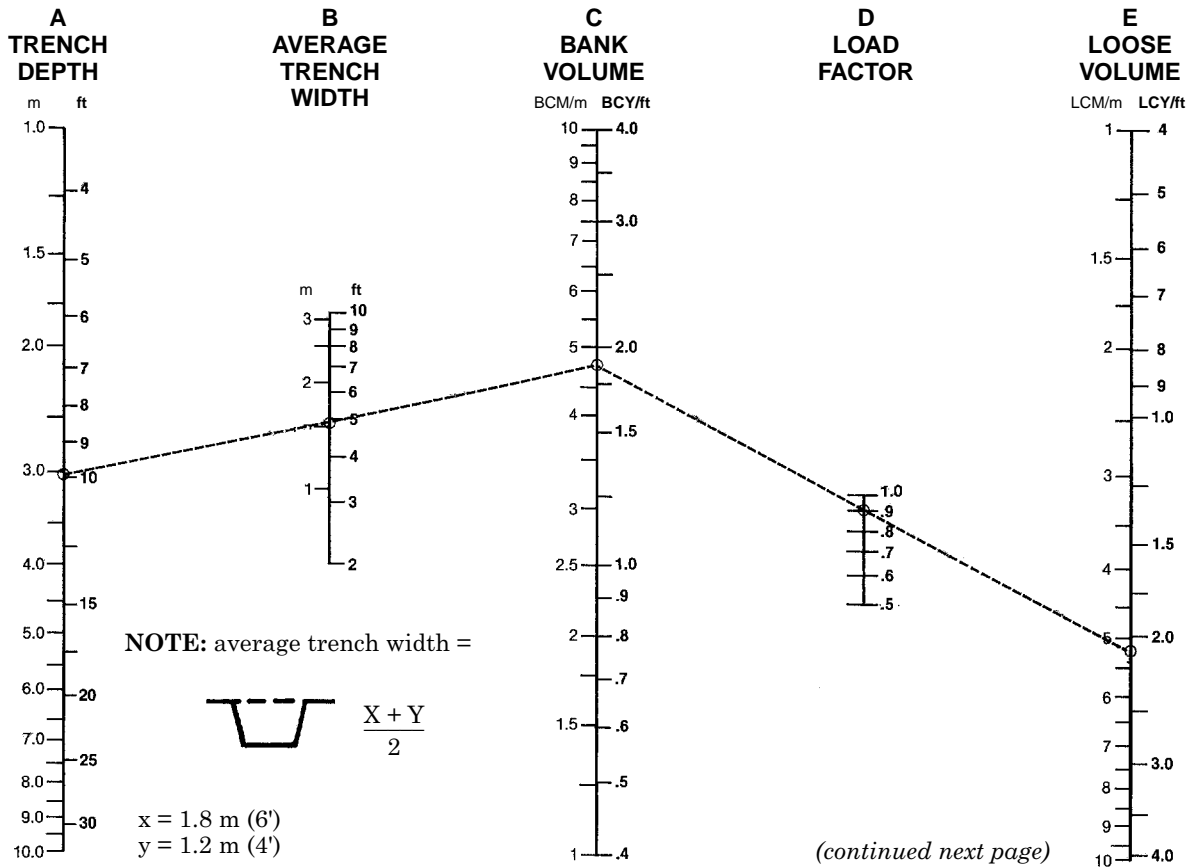

(get loose volume from scale E and enter on this page scale E)

- 5) Enter required linear production rate 9 m/h (30 t/hr) on scale G.
- 6) Connect E and G. Transfer hourly production rate from scale F to scale K (next page).

- 7) Estimate cycle time (23 sec) based on anticipated conditions and enter on scale H.
- 8) Estimate hourly digging time (27 min) and enter on scale I.
- 9) Connect H through I to scale J for cycles per hour.

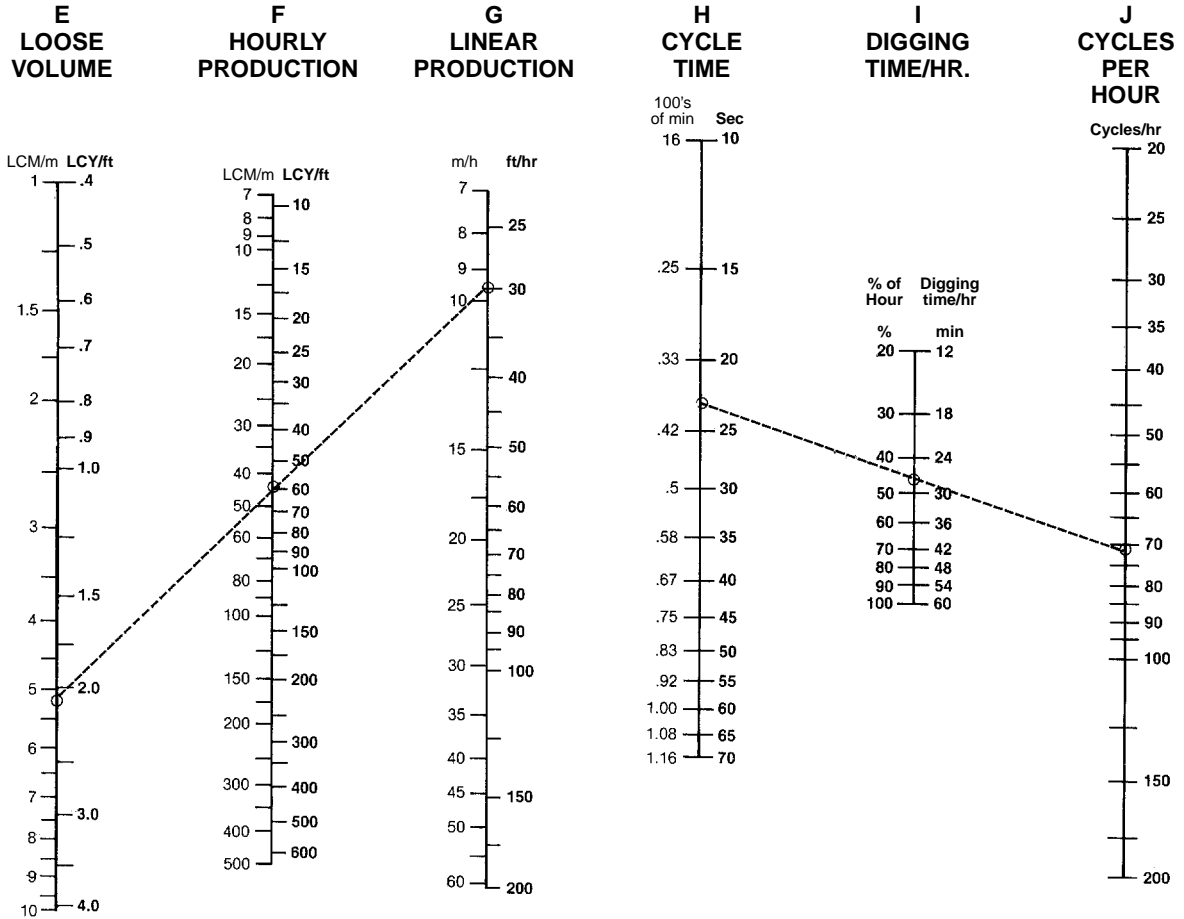

(get cycles per hour from scale J and enter on this page scale J)

- 10) Connect J through K to scale L for required volume per cycle.
- 11) Enter estimated bucket fill factor (100%) on scale M.
- 12) Connect L through M to scale N for required bucket size.

NOTE: Ensure bucket width does not exceed minimum trench width and also that weight of bucket and payload does not exceed machine working weight capacity (see lift capacity charts in this section).

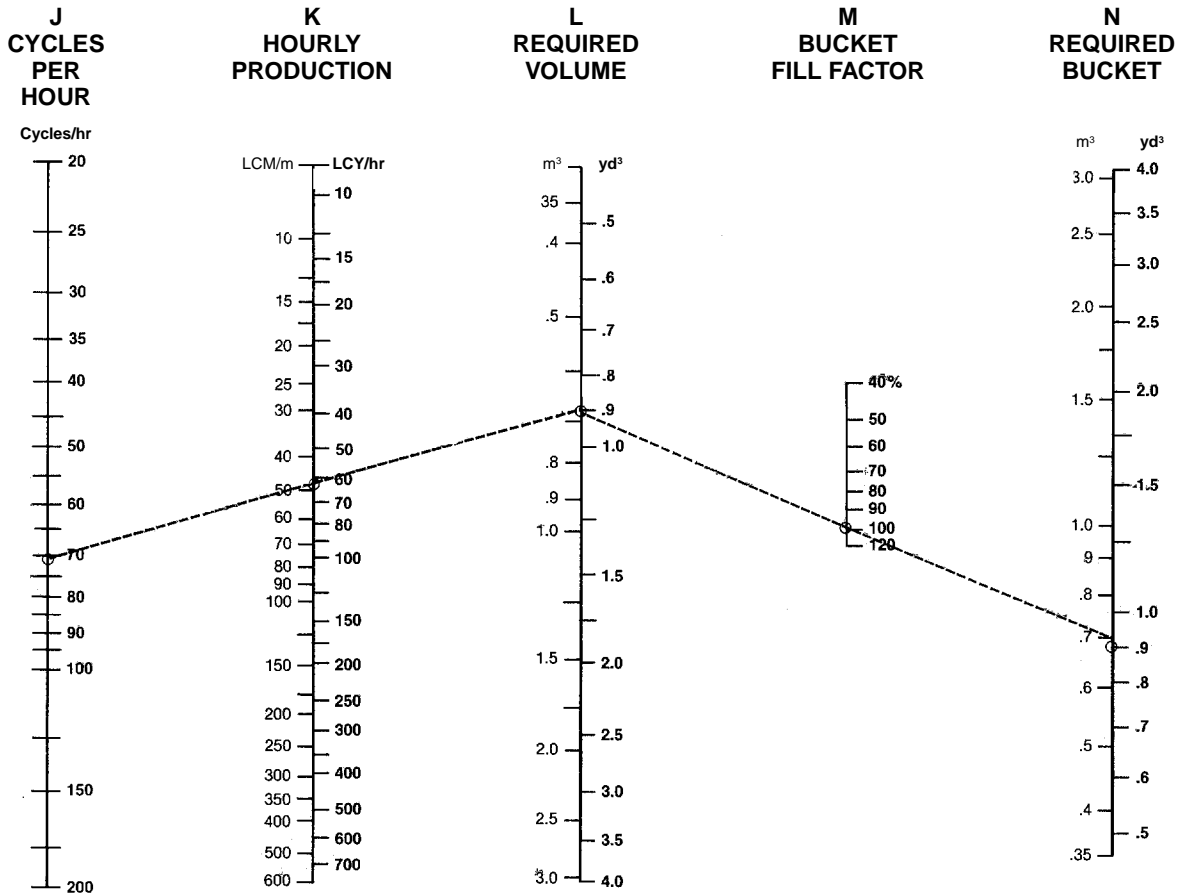

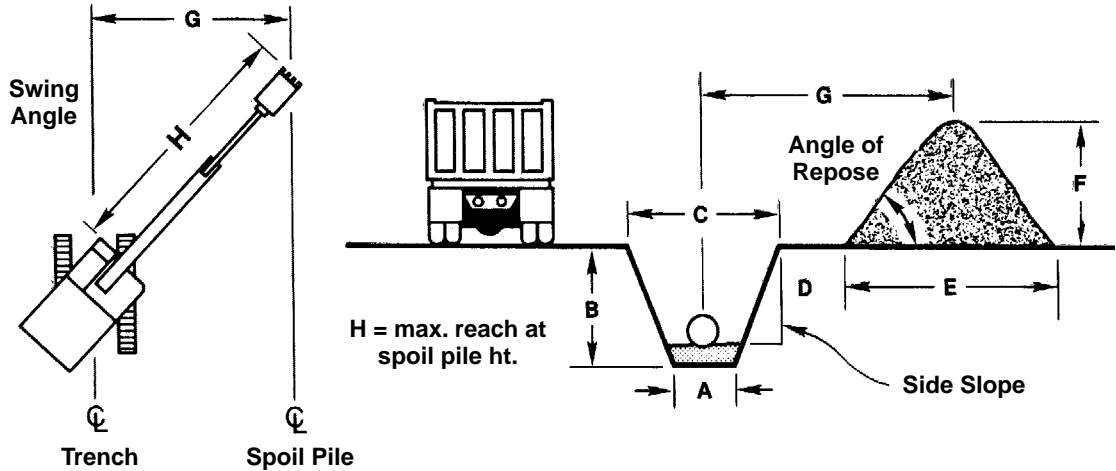

Excavation Volumes Per Meter or Foot of Trench Length

Metric version

Bank m³/meter = (Trench end area m²) × (one m)
 Trench volume (Bm³/m) = ½ (A + C) × B
 Spoil pile volume (Lm³/m) = (Bm³/m) × (1.00 + % Swell)

English version

Bank yd³/foot = $\frac{(\text{Trench end area ft}^2) \times (\text{one ft})}{27}$
 Trench volume (BCY/ft) = $\frac{1/2 (A + C) \times B}{27}$
 Spoil pile volume (LCY/ft) = (BCY/ft) × (1.00 + % Swell)

The following table provides a general guide to trench bottom width for various outside diameters of pipe.

Pipe Diameter		Trench Width		Pipe Diameter		Trench Width	
mm	ft/in	m	ft	mm	ft	m	ft
102	4"	0.49	1'7"	1524	5'0"	2.59	8'6"
152	6"	0.55	1'10"	1676	5'6"	2.80	9'2"
203	8"	0.61	2'0"	1829	6'0"	3.05	10'0"
254	10"	0.70	2'4"	1981	6'6"	3.26	10'8"
305	12"	0.76	2'6"	2134	7'0"	3.47	11'5"
381	15"	0.91	3'0"	2286	7'6"	3.69	12'1"
457	18"	1.03	3'5"	2438	8'0"	3.93	12'11"
533	19"	1.16	3'10"	2591	8'6"	4.15	13'7"
610	2'0"	1.25	4'1"	2743	9'0"	4.36	14'4"
686	2'3"	1.37	4'6"	2896	9'6"	4.54	14'11"
838	2'9"	1.58	5'2"	3048	10'0"	4.75	15'7"
914	3'0"	1.70	5'7"	3200	10'6"	4.99	16'5"
1067	3'6"	1.92	6'4"	3353	11'0"	5.21	17'1"
1219	4'0"	2.13	7'0"	3505	11'6"	5.43	17'10"
1372	4'6"	2.38	7'10"	3658	12'0"	5.64	18'6"

NOTE: Trench widths based on 1.25 Bc + 1.0 where Bc is the outside diameter of the pipe in feet.
 Table courtesy of American Concrete Pipe Association

- Trenching Rate With Pipesetting
- Pipesetting Example Problem

Trenching Production with Pipesetting

On many sewer construction jobs the excavator does more than just dig the trench. Other tasks include handling the shoring system, placing bedding material, and lowering the pipe. The normal work procedure is to open a section of trench and then stop and make a pipe installation before going on to dig the next section of trench. At that point the key to trenching production is the total amount of time required to install each section of pipe. Pipe installation time can be broken down as follows:
Digging time + other time = Total pipe installation time

Total Pipe Installation Time	Pipe Installed Per Hour
60 min	1 Pipe/hr
30 min	2 Pipe/hr
15 min	4 Pipe/hr
10 min	6 Pipe/hr

Digging Time can be calculated once the trenching rate has been calculated using the methods described earlier in this section. Once Digging Time has been calculated, it can be added to an estimate of "Other Time" to determine Total Pipe Installation Time. "Other Time" can be estimated based on a contractor's judgment, experience, or actual measurement on a job. The following formula and table relate the trenching rate of the excavator to the time required to open a section of trench for pipe of various lengths.

$$\text{Digging Time (Min.)} = \frac{\text{Pipe Length (ft)}}{\text{Trenching Rate (ft/hr)}} \times 60 \text{ (Min/hr)}$$

Trenching Rate Ft. Per Hour	Time Required to Dig for Pipe of Various Lengths							
	8 ft Pipe		12 ft Pipe		16 ft Pipe		20 ft Pipe	
	Hours	Min.	Hours	Min.	Hours	Min.	Hours	Min.
20 ft/hr	0.400	24.00	0.600	36.00	0.800	48.00	1.000	60.00
40	0.200	12.00	0.300	18.00	0.400	24.00	0.500	30.00
60	0.130	8.00	0.200	12.00	0.260	16.00	0.333	20.00
80	0.100	6.00	0.150	9.00	0.200	12.00	0.250	15.00
100	0.080	4.80	0.120	7.20	0.160	9.60	0.200	12.00
120	0.060	4.00	0.100	6.00	0.120	7.20	0.167	10.00
140	0.057	3.43	0.086	5.14	0.114	6.86	0.143	8.57
160	0.050	3.00	0.075	4.50	0.100	6.00	0.125	7.50
180	0.044	2.66	0.067	4.00	0.089	5.33	0.111	6.67
200	0.040	2.40	0.060	3.60	0.080	4.80	0.100	6.00

This table can be used to show how an excavator that is capable of more trenching production will provide significant advantages even on jobs where the

machine does not dig all of the time. Consider 12,000' job with 12' sections of pipe (1000 pipe to be installed). Excavator "A" can work at 60 ft/hr while Excavator "B" is capable of producing 120 ft/hr. Table shows that Excavator "B" will only take 0.10 hr to do the same work. This means that over the course of installing the 1000 pipe the more productive machine will save 0.10 hr/pipe or 100 hours of working time.

Example problem (English)

The following example shows how trenching production can be calculated on a job where the excavator is also required to set pipe. This example is based on the assumption that the excavator's earthmoving rate and the pipe installation time have already been estimated by the contractor.

Problem: Contractor estimates that the 350 Excavator will be able to produce 500 LCY/60 min. hr. Survey shows that an average cross section trench contains 3.2 BCY/ft and swell factor for sandy clay soil is estimated at 25%. How much trenching production can a contractor expect; assuming it takes 10.0 min. to install each 20 ft length of pipe after trench has been opened. Also assume 83% job efficiency — 50 min. work hour and 8 work hours out of a 9 hour shift. (0.5 hours for lunch and two 15 minute breaks.)

Solution:

Convert trench volume to LCY/ft:

$$1.25 (3.2 \text{ BCY/ft}) = 4.0 \text{ LCY/ft}$$

Convert Earthmoving rate to Trenching rate:

$$\frac{500 \text{ LCY/hr}}{4.0 \text{ LCY/ft}} = 125 \text{ ft/hr}$$

Calculate digging time for each pipe:

$$\frac{20 \text{ ft/pipe}}{125 \text{ ft/hr}} = 0.16 \text{ hr/pipe} = 9.6 \text{ min}$$

Calculate pipe installation time:

$$\begin{aligned} \text{Digging time} &= 9.6 \text{ min} \\ \text{Other time} &= 10.0 \text{ min} \\ \text{Pipe Installation time} &= 19.6 \text{ min} \end{aligned}$$

Calculate pipe installations/hour:

$$\frac{60 \text{ min/hr}}{19.6 \text{ min/pipe}} = 3.06 \text{ pipe/hr}$$

Calculate max. pipe installations/day:

$$8 \text{ hrs} (3.06 \text{ pipe/hr}) = 24.48 \text{ pipe/day}$$

Actual pipe/day:

$$0.83 (24.48 \text{ pipe/day}) = 20.3 - 20 \text{ pipe/day}$$

Actual feet/day:

$$(20 \text{ pipe/day}) \times (20 \text{ ft/pipe}) = 400 \text{ ft/day}$$

5000 SERIES EXCAVATORS AND SHOVELS

CONTENTS

Features	4-161
Specifications	4-162
Digging envelopes	4-168
Shipping information	4-170
General dimensions	4-172
Shoe selection	4-173
Curl and Crowd forces	4-173
Bucket selection	4-174
Vital Information Management	
System (VIMS)	4-174
Estimating cycle time	4-175
Production tables	4-177

Features:

- **Modular design** on the 5130B/5230 provides enhanced service access, isolated cooling systems for improved efficiency, superior stability through lower center of gravity and simplified assembly/disassembly process. Modules mount to the main frame on vertical shear ledges. The Right Hand (RH) or Power module includes the engine, pump drive, pumps, filters and engine radiator. A bulkhead separates the pump drive and engine compartments. Space between the engine and radiator allows the engine to be disconnected, slid forward and lifted from the module. The Left Hand (LH) or Cooler/Fluids module includes the hydraulic tank and filters, hydraulic coolers, fuel tank, autolube system, and cab riser. The cab riser allows standup access to hydraulic pilot lines, electrical components, VIMS Main module, windshield washer reservoir, and cab air filters.
- **Large castings in critical areas** provide superior stress resistance eliminating welds in high stress areas. Boom and stick castings provide structure designs which improve visibility over competitive designs. Large single floating pins mount the boom to main frame, boom to stick and stick to bucket. Single pins provide additional strength to these critical areas. Caterpillar's shovel manufacturing facility uses the latest machining and manufacturing processes. Large five plane machining center performs the precision milling required to mount the swing bearing to the carbody eliminating the need for a swing bearing collar assembly.
- **Proportional Priority Pressure Compensation hydraulic system** delivers excellent controllability with efficient full-powered response. The system uses a closed center design. Pressure compensation senses implement loads/pressures and meters pump flow according to implement requirements. Pumps deliver only the flow necessary to do the work. The 5130B/5230 hydraulics have proportioning or flow modulation that senses the implement loads. Implement valves adjust to provide consistent and constant feel modulation. PPPC valves deliver flow proportional to joy stick deflection. The flow remains proportional even as pressures change due to increased loads. Operation is smooth and predictable with reduced effort improving operator efficiency.
- **Undercarriage track roller frames** on the 5130B/5230 attach to the carbody on large precision machined surfaces with 32 dowels pressed fit into the carbody. These dowels provide superior resistance to shear loads between the carbody/upper structure and the track roller frames. Automatic track tension eliminates manual adjustments. Accumulators absorb shock loads caused by debris passing through the undercarriage. Sloped track roller frames resist material build up improving component life. The 5000 U/C uses solid track pins and positive pin retention. All undercarriage components are lifetime lubricated for reduced maintenance. A hunting tooth drive sprocket alternates tooth-pin engagement resulting in extended undercarriage life. The 5230 uses a patented shovel style single piece cast shoe/link assembly. Two solid floating pins join the shoe/link casting providing even pin wear. Four load bearing surfaces increase undercarriage life and eliminate track walking.



MODEL	5080	5130B	5230
Sourcing	U.S.	U.S.	U.S.
Flywheel Horsepower	319 kW	597 kW	1095 kW
Operating Weight*	83 800 kg	181 000 kg	318 500 kg
Bucket Capacity Range (heaped)	5.2 m ³	9-11 m ³	12.5-17 m ³
Engine Model	3406C	3508B EUI	3516 EUI
Rated Engine RPM	1800	1750	1750
No. of Cylinders	6	8	16
Bore	137 mm	170 mm	170 mm
Stroke	165 mm	190 mm	190 mm
Displacement	14.6 L	34.5 L	69.1 L
Max. Hydraulic Pump Output at Rated RPM: Implement	2 × 430 L/min	4 × 372 L/min	6 × 372 L/min
Swing	1 × 340 L/min	1 × 464 L/min	2 × 464 L/min
Relief Valve Setting:			
Implement Circuits	31 400 kPa	31 000 kPa	31 000 kPa
Travel Circuits	34 300 kPa	35 000 kPa	35 000 kPa
Swing Circuits: Accelerate	27 500 kPa	35 000 kPa	35 000 kPa
Decelerate	27 500 kPa	25 000 kPa	25 000 kPa
Pilot Circuits	3500 kPa	4000 kPa	4000 kPa
Maximum Drawbar Pull	546 kN	872 kN	1545 kN
Maximum Travel Speed at Rated RPM	Low: 2.7 km/h High: 4.4 km/h	— 3.3 km/h	— 2.5 km/h
Overall Track Length**	4.6 m	5.55 m	6.26 m
Track Gauge	3.51 m	4.72 m	5.12 m
Grouser Height	48 mm	29, 71 mm	15 mm
Track Shoe Widths	610, 750 mm	650, 800, 1000 mm	1100, 1300, 1500 mm
Ground Contact Areas	6.13, 7.55 m ²	8.0, 9.8, 12.3 m ²	15.2, 18.0, 20.8 m ²
Ground Pressures	132, 107 kPa	217, 178, 144 kPa	205, 174, 153 kPa
Fuel Tank Refill Capacity	990 L	2600 L	5330 L

*Operating Weights include coolant, lubricants, full fuel tank, standard shoes, bucket, and operator.

**Track length measured from center of idler to center of sprocket.

Adjustments to Standard Operating Weight

Track	5080	610 mm Track 750 mm Track	0 kg +966 kg
	5130B	650 mm Track 800 mm Track 1000 mm Track	0 kg +2050 kg +4320 kg
	5230	1100 mm Track 1300 mm Track 1500 mm Track	0 kg +2320 kg +5370 kg
Buckets	5080	G.P. Rock Bucket (5.2 m ³)	0 kg
	5130B	Rock Bucket (11.0 m ³) High Density (9.0 m ³)	0 kg -225 kg
	5230	Rock Bucket (17.0 m ³) High Density (14.5 m ³) High Density (12.5 m ³)	0 kg -3050 kg -3750 kg



MODEL	5080	5130B	5230
Sourcing	U.S.	U.S.	U.S.
Flywheel Horsepower	428 hp	800 hp	1470 hp
Operating Weight*	184,600 lb	399,000 lbs	702,000 lbs
Bucket Capacity Range (heaped)	6.8 yd ³	12.0-14.5 yd ³	16.3-22.2 yd ³
Engine Model	3406C ATAAC	3508B EUI	3516 EUI
Rated Engine RPM	1800	1750	1750
No. of Cylinders	6	8	16
Bore	5.4"	6.7"	6.7"
Stroke	6.5"	7.5"	7.5"
Displacement	891 in ³	2105 in ³	4211 in ³
Max. Hydraulic Pump Output at Rated RPM: Implement	2 × 114 gpm	4 × 99 gpm	6 × 99 gpm
Swing	1 × 90 gpm	1 × 123 gpm	2 × 123 gpm
Relief Valve Setting:			
Implement Circuits	4550 psi	4500 psi	4500 psi
Travel Circuits	4980 psi	5080 psi	5080 psi
Swing Circuits: Accelerate	3980 psi	5080 psi	5080 psi
Decelerate	3980 psi	3620 psi	3620 psi
Pilot Circuits	505 psi	580 psi	580 psi
Maximum Drawbar Pull	122,850 lb	196,000 lb	340,875 lb
Maximum Travel Speed at Rated RPM	Low: 1.7 mph High: 2.7 mph	— 2.1 mph	— 1.6 mph
Overall Track Length**	15'1"	18'3"	20'6"
Track Gauge	11'6"	15'6"	17'
Grouser Height	2"	1.1", 2.8"	0.6"
Track Shoe Widths	24", 30"	26", 32", 39"	43", 51", 59"
Ground Contact Areas	66, 81.3 ft ²	86.1, 105.4 ft ²	163.6, 193.7, 223.8 ft ²
Ground Pressures	19.2, 16 psi	31.4, 25.8, 20.9 psi	29.7, 25.3, 22.2 psi
Fuel Tank Refill Capacity	262 U.S. gal	687 U.S. gal	1386 U.S. gal

*Operating Weights include coolant, lubricants, full fuel tank, standard shoes, bucket, and operator.

**Track length measured from center of idler to center of sprocket.

Adjustments to Standard Operating Weight

Track	5080	2'0" Track 2'6" Track	0 lbs +2125 lbs
	5130B	2'2" Track 2'8" Track 3'3" Track	0 lbs +4520 lbs +9520 lbs
	5230	3'7" Track 4'3" Track 4'11" Track	0 lbs +5120 lbs +11,840 lbs
Buckets	5080	G.P. Rock Bucket (6.8 yd ³)	0 lbs
	5130B	Rock Bucket (14.4 yd ³) High Density (12.0 yd ³)	0 lbs -500 lbs
	5230	Rock Bucket (22.2 yd ³) High Density (19.0 yd ³) High Density (16.3 yd ³)	0 lbs -6700 lbs -8300 lbs



MODEL	5130B	5230
Sourcing	U.S.	U.S.
Flywheel Horsepower	597 kW	1095 kW
Operating Weight*	182 000 kg	316 600 kg
Bucket Capacity Range (heaped)	8.5-18.3 m ³	13-27.5 m ³
Engine Model	3508B EUI	3516 EUI
Rated Engine RPM	1750	1750
No. of Cylinders	8	16
Bore	170 mm	170 mm
Stroke	190 mm	190 mm
Displacement	34.5 L	69.1 L
Max. Hydraulic Pump Output at Rated RPM: Implement	4 × 372 L/min	6 × 372 L/min
Swing	1 × 464 L/min	2 × 464 L/min
Relief Valve Settings:		
Implement Circuits	31 000 kPa	31 000 kPa
Travel Circuits	35 000 kPa	35 000 kPa
Swing Circuits: Accelerate	35 000 kPa	35 000 kPa
Decelerate	25 000 kPa	25 000 kPa
Pilot Circuits	4000 kPa	4000 kPa
Maximum Drawbar Pull	872 kN	1545 kN
Maximum Travel Speed at Rated RPM	—	—
	3.3 km/h	2.5 km/h
Overall Track Length**	5.55 m	6.26 m
Track Gauge	4.72 m	5.12 m
Grouser Height	29,71 mm	15 mm
Track Shoe Widths	650, 800 mm	1100, 1300, 1500 mm
Ground Contact Areas	8.0, 9.8 m ²	15.2, 18.0, 20.8 m ²
Ground Pressures	218, 179, 145 kPa	202, 172, 151 kPa
Fuel Tank Refill Capacity	2600 L	5330 L

*Operating Weights include coolant, lubricants, full fuel tank, standard shoes, bucket, and operator.

**Track length measured from center of idler to center of sprocket.

Model	Boom	Stick Length m	Working Weights Buckets & Payload kg
5130B	8.0 m	3.8 m	28 500
		5.2 m	23 900
	11.0 m	3.8 m	18 250
5230	9.5 m	4.5 m	44 500

Adjustments to Standard Operating Weight

Track	5130B	650 mm Track 800 mm Track 1000 mm Track	-2050 kg 0 kg +2270 kg
	5230	1100 mm Track 1300 mm Track 1500 mm Track	-2320 kg 0 kg +5370 kg
Buckets	5130B	Rock (10.5 m ³) High Density (8.5 m ³) Excavation (10.5 m ³) Coal (13.6 m ³) Coal (18.3 m ³)	0 kg -1079 kg -500 kg -800 kg -130 kg
	5230	Rock (16.0 m ³) High Density (13.0 m ³) Rock (18.0 m ³) Coal (27.5 m ³)	0 kg -2000 kg +1800 kg -1140 kg

5000 Series — Excavators

Specifications ● English



MODEL	5130B	5230
Sourcing	U.S.	U.S.
Flywheel Horsepower	800 hp	1470 hp
Operating Weight*	401,000 lb	698,000 lb
Bucket Capacity Range (heaped)	11.0-24.0 yd ³	17-36 yd ³
Engine Model	3508B EUI	3516 EUI
Rated Engine RPM	1750	1750
No. of Cylinders	8	16
Bore	6.7"	6.7"
Stroke	7.5"	7.5"
Displacement	2105 in ³	4211 in ³
Max. Hydraulic Pump Output at Rated RPM: Implement	4 × 99 gpm	6 × 99 gpm
Swing	1 × 123 gpm	2 × 123 gpm
Relief Valve Settings:		
Implement Circuits	4500 psi	4500 psi
Travel Circuits	5080 psi	5080 psi
Swing Circuits: Accelerate	5080 psi	5080 psi
Decelerate	3620 psi	3620 psi
Pilot Circuits	580 psi	580 psi
Maximum Drawbar Pull	196,000 lb	340,875 lb
Maximum Travel Speed at Rated RPM	2.1 mph	1.6 mph
Overall Track Length**	18'3"	20'6"
Track Gauge	15'6"	17'
Grouser Height	1.1", 2.8"	0.6"
Track Shoe Widths	26", 32"	43", 51", 59"
Ground Contact Areas	86.1, 105.5 ft ²	163.6, 193.7, 346.6 ft ²
Ground Pressures	31.6, 26.0, 21.0 psi	29.4, 25.0, 21.9 psi
Fuel Tank Refill Capacity	687 U.S. gal	1386 U.S. gal

*Operating Weights include coolant, lubricants, full fuel tank, standard shoes, bucket, and operator.

**Track length measured from center of idler to center of sprocket.

Model	Boom	Stick Length ft	Working Weights Buckets & Payload lb
5130B	26'3"	12'6" 17'1"	62,800 52,700
	36'1"	12'6"	35,800
5230	31'2"	14'9"	98,100

Adjustments to Standard Operating Weight

Track	5130B	2'2" Track 2'8" Track 3'3" Track	-4520 lbs 0 lbs +5000 lbs
	5230	3'7" Track 4'3" Track 4'11" Track	-5120 lbs 0 lbs +6720 lbs
Buckets	5130B	Rock (13.7 yd ³) High Density (11.0 yd ³) Excavation (13.7 yd ³) Coal (17.8 yd ³) Coal (24.6 yd ³)	0 lbs -2380 lbs -2080 lbs -2760 lbs -1280 lbs
	5230	Rock (20.9 yd ³) High Density (17 yd ³) Rock (24.2 yd ³) Coal (36 yd ³)	0 lbs -4400 lbs +4000 lbs -2500 lbs

**5000 Series —
Front Shovels**

Digging Envelopes

- 5080
- 5130B
- 5230

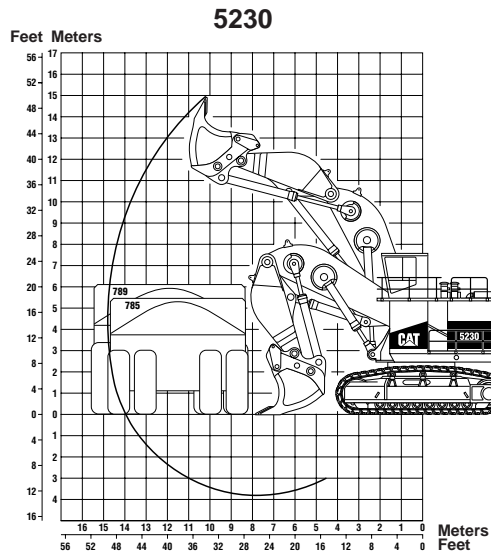
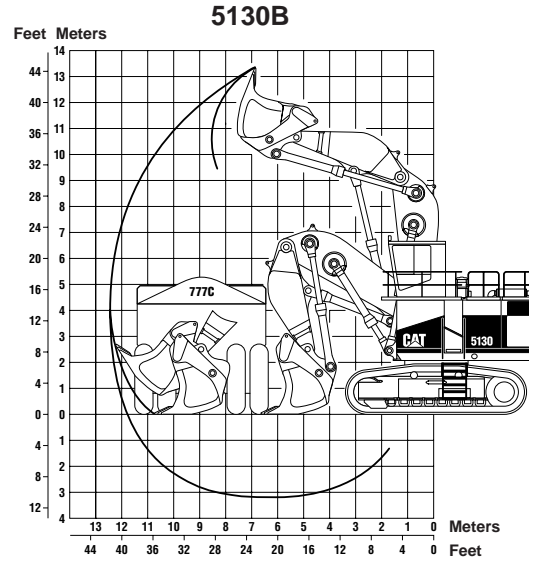
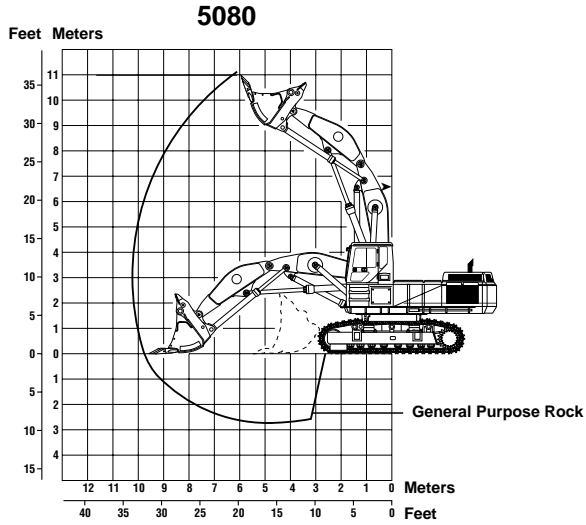

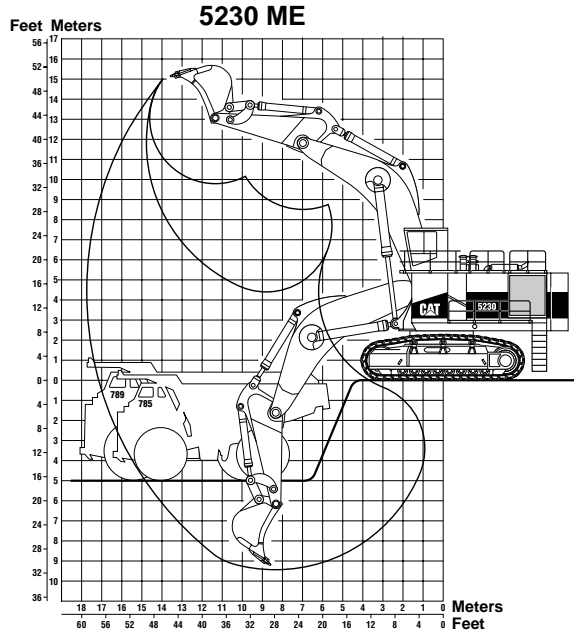
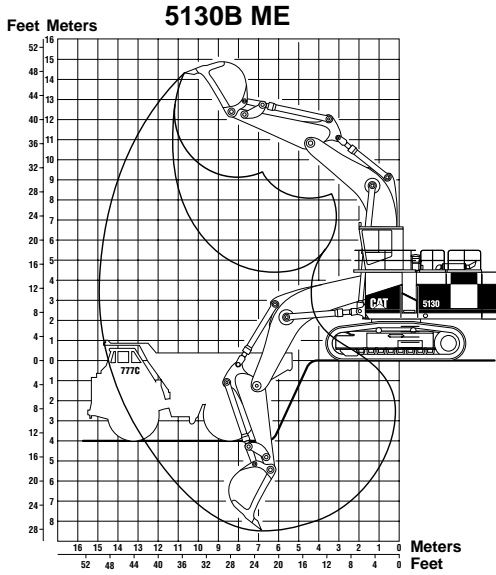

● 5130B ME

	Weight		Length		Width		Height	
	kg	lb	mm	ft	mm	ft	mm	ft
Carbody	15 800	34,820	3560	11'8"	4110	13'6"	1520	5'0"
Swing Frame	22 830	50,340	7060	23'2"	2460	8'1"	2440	8'0"
Track Roller Frame (each)								
650 mm (2'2") Shoes	23 610	52,060	7140	23'5"	1500	4'11"	1910	6'3"
800 mm (2'7") Shoes	24 640	54,320	7140	23'5"	1500	4'11"	1910	6'3"
1000 mm (3'3") Shoes	25 770	56,820	7140	23'5"	1500	4'11"	1910	6'3"
Left Module	8090	17,830	5770	18'11"	2340	7'8"	2620	8'7"
Boom Cylinders	3000	6620	3840	12'7"	910	3'0"	690	2'3"
Stick Cylinders	1100	2430	3840	12'7"	910	3'0"	690	2'3"
Bucket Cylinders	1100	2430	3840	12'7"	910	3'0"	690	2'3"
Ladders	2070	4570	2240	7'4"	1090	3'7"	1190	3'11"
Parts Box	2100	4620	2240	7'4"	1090	3'7"	990	3'3"
Handrails	1150	2540	3990	13'1"	2290	7'6"	1120	3'8"
Right Module	13 810	30,440	5660	18'7"	2440	8'0"	3050	10'0"
Cab	2050	4510	2360	7'9"	2060	6'9"	3100	10'2"
Boom	20 530	45,260	8560	28'1"	1980	6'6"	3400	11'2"
Counterweight	20 970	46,220	6250	20'6"	1170	3'10"	2510	8'3"
Stick	6220	13,710	5260	17'3"	1020	3'4"	2290	7'6"
Brackets	1550	3420	1520	5'0"	1450	4'9"	790	2'7"
Bucket	9700	21,380	2900	9'6"	3200	10'6"	2820	9'3"

● 5230 ME

	Weight		Length		Width		Height	
	kg	lb	mm	ft	mm	ft	mm	ft
Carbody	24 770	54,610	4470	14'8"	3840	12'7"	1980	6'6"
Swing Frame	40 590	89,490	8890	29'2"	3330	10'11"	3480	11'5"
Track Roller Frame (each)								
1100 mm (3'7") Shoes	45 400	100,080	8030	26'4"	1830	6'0"	2360	7'9"
1300 mm (4'3") Shoes	46 560	102,640	8030	26'4"	1830	6'0"	2360	7'9"
1500 mm (4'11") Shoes	48 080	106,000	8030	26'4"	1830	6'0"	2360	7'9"
Left Module	12 310	27,140	7190	23'7"	2510	8'3"	3230	10'7"
Cylinder Skid	3130	6900	4170	13'8"	610	2'0"	810	2'8"
Cylinder Skid	3130	6900	4170	13'8"	610	2'0"	810	2'8"
Cylinder Skid	4350	9580	4880	16'0"	910	3'0"	740	2'5"
Cylinder Skid	3290	7260	4170	13'8"	910	3'0"	740	2'5"
Parts Box	2220	4890	2240	7'4"	1090	3'7"	990	3'3"
Parts Box	2170	4780	2240	7'4"	1090	3'7"	990	3'3"
Parts Box	2220	4900	2240	7'4"	1090	3'7"	990	3'3"
Handrails	1350	2980	3990	13'1"	2290	7'6"	1120	3'8"
Right Module	20 880	46,040	7570	24'10"	2510	8'3"	3580	11'9"
Cab	2380	5240	2360	7'9"	2060	6'9"	3050	10'0"
Boom	28 340	62,480	10 030	32'11"	3960	13'0"	2490	8'2"
Counterweight	41 390	91,240	7320	24'0"	1220	4'0"	3050	10'0"
Stick	11 030	24,320	6250	20'6"	1350	4'5"	2570	8'5"
Brackets	2590	5720	1780	5'10"	1680	5'6"	890	2'11"
Guards	940	2080	2080	6'10"	1700	5'7"	840	2'9"
Bucket	16 380	36,110	4010	13'2"	3250	10'8"	3100	10'2"

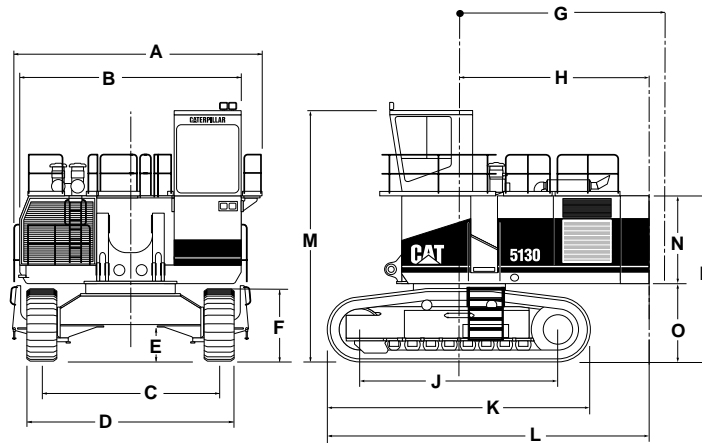

	5080		5130B ME		5230 ME	
A	4400 mm	14'5"	6620 mm	21'9"	7510 mm	24'7"
B	3470 mm	11'5"	5900 mm	19'4"	6960 mm	22'11"
C	3510 mm	11'6"	4720 mm	15'6"	5196 mm	17'0"
D	4120 mm	13'6"	5370 mm	17'7"	6296 mm	20'8"
E	890 mm	2'11"	960 mm	3'2"	1108 mm	3'8"
F	—	—	1890 mm	6'3"	2260 mm	7'5"
G Swing radius	4200 mm	13'9"	5250 mm	17'3"	6450 mm	21'2"
H	4200 mm	13'9"	5140 mm	16'11"	6280 mm	20'7"
J	4600 mm	15'1"	5552 mm	18'3"	6260 mm	20'6"
K	5840 mm	19'2"	7270 mm	23'10"	8174 mm	26'10"
L	7120 mm	23'4"	8775 mm	28'9"	10 325 mm	33'10"
M	4820 mm*	15'10"	6550 mm	21'5"	7455 mm	24'5"
N	—	—	2350 mm	7'9"	2850 mm	9'4"
O	1620 mm	5'4"	2045 mm	6'9"	2450 mm	8'0"
P	—	—	4395 mm	14'5"	5300 mm	17'5"

*Euro cab with FOPS.

CHOOSING A TRACK SHOE

In severe underfoot conditions, narrow shoes impose lower forces on other undercarriage components, and normally result in improved overall track life. Machines working in rock should be equipped with the narrowest available shoe. Wider shoes will improve flotation, but shoes wider than those shown here should not be used. Track shoe width has little effect on stability.

Double grouser shoes will provide adequate traction in most underfoot conditions, and are less damaging to floor and road surfaces. For additional traction in deep mud, or in rock applications which allow some grouser penetration, single grouser shoes are recommended. Hard, smooth quarry floors that allow little or no grouser penetration are best handled by the narrowest double grouser shoes.

Track Shoe Widths and Ground Pressures

Model	Shoe	GROUND PRESSURE	
		With Bottom Dump Bucket	
		kPa	psi
5080 Front Shovel	610 mm (2'0") double grouser	132	19.2
	750 mm (2'6") double grouser	107	16.0
5130B Front Shovel	650 mm (2'2")	215	31.2
	800 mm (2'8")	174	25.3
	1000 mm (3'3")	144	20.9
5230 Front Shovel	1100 mm (3'7")	202	29.3
	1300 mm (4'3")	171	24.8
	1500 mm (4'11")	148	21.5

CURL AND CROWD FORCES

Rated digging forces are the forces that can be exerted at the outermost cutting point. They are calculated by applying working relief hydraulic pressure to the cylinder(s) providing the digging force. Weight of components and friction are excluded from the calculations.

Rated Arm (Stick) Force — is generated by the arm (stick) cylinder and is tangent to the arc of radius "A". The arm is positioned to obtain the maximum output moment from the arm cylinder with the bucket positioned as in figure 1.

Rated Bucket Tangential Force — is generated by the bucket cylinders and is tangent to the arc of radius "B". The bucket is positioned to obtain the maximum output moment from the bucket cylinders and connecting linkage as in figure 2.

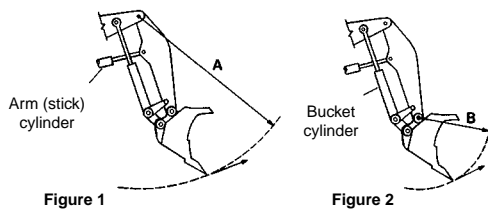

Model	Bucket	Bucket Capacity		A — Crowd Force		B — Bucket Tangential Force	
		m ³	yd ³	kN	lb	kN	lb
5080 Front Shovel	Bottom Dump	5.2	6.8	434	97,600	451	101,500
5130B Front Shovel	Bottom Dump	11.0	14.5	770	173,000	715	161,000
5230 Front Shovel	Bottom Dump	17.0	22.2	1250	281,000	1125	253,000

**MAJOR BOTTOM DUMP BUCKET
APPLICATION FEATURES:**

- Controlled dumping action permits more accurate loading of narrow trucks with less chance of spillage. Closer bucket positioning over the truck, and metering the material flow on the first pass, lessens impact on truck bodies increasing their life.

- The bottom-dump clamping action is ideal for sorting in rock applications. Oversized material can be segregated for secondary breakage. In some cases, the operator can screen material as he dumps by limiting the bucket opening.
- Sticky material is easier to dislodge, thus avoiding material build-up which robs production. The bottom-dump bucket bulldozer assembly is nearly vertical when the bucket is fully open.

Bucket Selection

Model	Heaped Capacity		Struck Capacity		Weight		Width	
	m ³	yd ³	m ³	yd ³	kg	lb	m	ft
5080 General Purpose	5.2	6.8	4.1	5.4	8893	19,610	2.59	8'6"
5130B Front Shovel General Purpose	11.0	14.5	NA	NA	15 790	34,820	3.64	11'11"
Rock	11.0	14.5	NA	NA	17 960	39,500	3.64	11'11"
Hi-density Rock	9.0	12.0	NA	NA	17 700	39,000	3.06	10'0"
5230 Front Shovel Rock	17.0	22.2	NA	NA	29 820	65,740	4.36	14'4"
Hi-density Rock	15.5	20.2	NA	NA	28 580	63,000	3.67	12'0"

**VITAL INFORMATION MANAGEMENT
SYSTEM (VIMS):**

VIMS is a Caterpillar exclusive advanced diagnostic and equipment management tool designed to lower operating costs. Equipment utilization can be improved through higher mechanical availability, optimized component life, reduced risk of catastrophic failures, faster diagnostics and improved serviceability. VIMS includes both on-board hardware and an off-board software package — VIMS-PC.

The VIMS system “coaches” the operator to improve vehicle performance and productivity. On-board, VIMS is designed to work with the operator and not interfere with equipment operation. In-cab modules provide meaningful messages, indicators, gauges and warnings from sensors located throughout the machine. VIMS provides the operator immediate access to current machine information. VIMS data can also be transmitted for in-office/remote machine monitoring and analysis.

The CAT DATA LINK is the on-board network allowing communication between VIMS and the many machine mounted electronic control modules.

VIMS is like having a first rate mechanic riding in the cab with all of his diagnostic tools connected to the machine. Listening, watching, monitoring the entire vehicle by converting data signals from various sensors into meaningful information. VIMS displays information in “real-time” and records and stores information similar to a Flight Data Recorder on an airplane.

VIMS works with four types of information: 1. Internal (e.g.: service meter hours); 2. Sensed (e.g.: Exhaust Temperature); 3. Communicated (e.g.: Tach from ECM); 4. Calculated (e.g.: fuel consumption).

VIMS organizes and stores information into six categories: 1. Event List; 2. Event Recorder; 3. Data Logger; 4. Trends; 5. Cumulatives; 6. Histograms.

VIMS provides value to more than the operator. Whether you’re in operations, maintenance, engineering, planning or management — Caterpillar’s VIMS is your best choice for maximizing availability, productivity and reducing the risk of catastrophic failure while lowering overall cost.

ESTIMATING FRONT SHOVEL CYCLE TIME

The loading cycle of the front shovel is composed of four segments:

- 1. Load bucket 3. Dump bucket
- 2. Swing loaded 4. Swing empty

Total shovel cycle time is dependent on machine size and job conditions. As conditions become more severe (tougher loading, more obstacles, etc.), the shovel slows down accordingly.

The following table breaks down what experience has shown to be typical Caterpillar Front Shovel cycle times with above average job conditions and an operator of average ability.

These times would decrease as job conditions or operator ability improved and would become slower as conditions become less favorable. For example:

- Tough material Longer bucket fill and dump time.
- Greater swing angle Longer swing times.
- Operator ability Affects total cycle time.
- Loading from the top down May improve swing time.

MODEL	5080		5130B		5230	
Bucket Size	5.2 m ³	6.8 yd³	11.1 m ³	14.5 yd³	17.0 m ³	22.2 yd³
Soil Type	Shot rock		Shot rock		Shot rock	
Swing Angle	90°		90°		90°	
Load Area	No Obstructions		No Obstructions		No Obstructions	
Operator Ability	Average		Average		Average	
Load Bucket	0.16 Min.		0.18 Min.		0.20 Min.	
Swing Loaded	0.09 Min.		0.13 Min.		0.14 Min.	
Dump Bucket	0.03 Min.		0.04 Min.		0.05 Min.	
Swing Empty	0.09 Min.		0.10 Min.		0.10 Min.	
Total Cycle Time	0.37 Min.		0.45 Min.		0.49 Min.	

CYCLE TIME ESTIMATING CHART				
CYCLE TIME (MIN)	MACHINE AND BUCKET			CYCLE TIME (SEC)
	5080	5130B	5230	
				10
0.25				15
0.30				20
0.35				25
0.40				30
0.45				35
0.50				40
0.60				45
				50
0.75				55
				60
1.00				

**CYCLE TIME vs
JOB CONDITION DESCRIPTION**

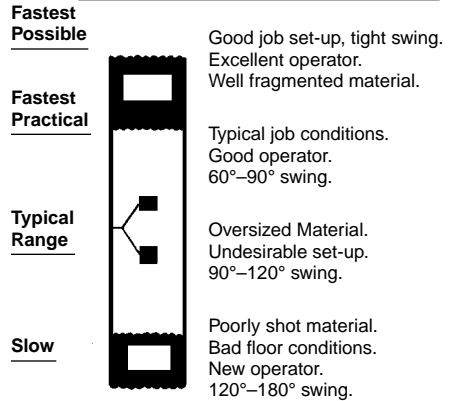

**BOTTOM DUMP BUCKET
FILL FACTORS**

Material	Fill Factor*
Bank Clay; Earth	100%-105%
Rock-Earth Mixture	100%-105%
Rock — Poorly Blasted	85%-95%
Rock — Well Blasted	95%-105%
Shale, Sandstone — Standing Bank	85%-100%

*Percent of heaped bucket capacity.

ROCK LOADING PRODUCTION TABLES

- Shot Rock
- Estimated Density — 1600 kg/Lm³ or 2700 lb/LCY (1.35 ton/LCY)

METRIC TONS PER 60 MIN. HOUR*

ESTIMATED CYCLE TIME		ESTIMATED BUCKET PAYLOAD** — LOOSE CUBIC METER					ESTIMATED CYCLES	
Cycle Time (Sec)	Cycle Time (Min)	2.6 m ³	3.8 m ³	7.5 m ³	8.8 m ³	12 m ³	Cycles/Minute	Cycles/Hour
15	0.25	998	1459	2880	3379	4608	4.0	240
18	0.30	832	1216	2400	2816	3840	3.0	200
21	0.35	711	1040	2052	2408	3283	2.9	171
25	0.42	599	876	1728	2028	2765	2.5	144
32	0.53	470	687	1356	1591	2170	1.9	113
40	0.67	374	547	1080	1267	1728	1.5	90
45	0.75	333	486	960	1126	1536	1.3	80
50	0.83	300	438	864	1014	1382	1.2	72

U.S. TONS PER 60 MIN. HOUR*

ESTIMATED CYCLE TIME		ESTIMATED BUCKET PAYLOAD** — LOOSE CUBIC YARD					ESTIMATED CYCLES	
Cycle Time (Sec)	Cycle Time (Min)	3.4 yd ³	5 yd ³	9.75 yd ³	11.5 yd ³	15.75 yd ³	Cycles/Minute	Cycles/Hour
15	0.25	1102	1620	3159	3726	5103	4.0	240
18	0.30	918	1350	2633	3105	4253	3.0	200
21	0.35	785	1154	2251	2655	3636	2.9	171
25	0.42	661	972	1895	2236	3062	2.5	144
32	0.53	519	763	1487	1754	2403	1.9	113
40	0.67	413	608	1185	1397	1914	1.5	90
45	0.75	367	540	1053	1242	1701	1.3	80
50	0.83	330	486	948	1118	1531	1.2	72

*Actual Hourly Production = (60 Min. Hr. Production) × (Job Efficiency Factor)

**Estimated Bucket Payload = (Heaped Bucket Capacity) × (Bucket Fill Factor)

These tables are calculated using a 100% bucket fill factor.

See bucket fill factors prior to the rock loading production charts.

EARTH LOADING PRODUCTION TABLES

METRIC Lm³ PER 60 MIN. HOUR

ESTIMATED CYCLE TIME		ESTIMATED BUCKET PAYLOAD — LOOSE CUBIC METER					ESTIMATED CYCLES	
Cycle Time (Sec)	Cycle Time (Min)	2.6 m ³	3.8 m ³	7.5 m ³	8.8 m ³	12 m ³	Cycles/Minute	Cycles/Hour
15	0.25	624	912	1800	2112	3880	4.0	240
18	0.30	520	760	1500	1760	2400	3.0	200
21	0.35	445	650	1283	1505	2052	2.9	171
24	0.40	390	570	1125	1320	1800	2.5	150
27	0.45	346	505	998	1170	1596	2.2	133
30	0.50	312	456	900	1056	1440	2.0	120
33	0.55	283	414	818	959	1308	1.8	109
36	0.60	260	380	750	880	1200	1.7	100

U.S. LCY PER 60 MIN. HOUR

ESTIMATED CYCLE TIME		ESTIMATED BUCKET PAYLOAD** — LOOSE CUBIC YARD					ESTIMATED CYCLES	
Cycle Time (Sec)	Cycle Time (Min)	3.4 yd ³	5 yd ³	9.75 yd ³	11.5 yd ³	15.75 yd ³	Cycles/Minute	Cycles/Hour
15	0.25	816	1200	2340	2760	3780	4.0	240
18	0.30	680	1000	1950	2300	3150	3.0	200
21	0.35	581	855	1667	1967	2693	2.9	171
24	0.40	510	750	1463	1725	2363	2.5	150
27	0.45	452	665	1297	1530	2095	2.2	133
30	0.50	408	600	1170	1380	1890	2.0	120
33	0.55	370	545	1063	1254	1717	1.8	109
36	0.60	340	500	975	1150	1575	1.7	100

NOTE: This page compiled from Owning and Operating Section for your convenience. All terms, conditions etc. stated in the O & O Section also apply to this page.

OWNERSHIP PERIOD

Model	Zone A	Zone B	Zone C
5130B	60,000 hr	50,000 hr	40,000 hr
5230	60,000 hr	50,000 hr	40,000 hr

FUEL CONSUMPTION

Model	Low		Medium		High	
	liter	U.S. gal	liter	U.S. gal	liter	U.S. gal
5130B	91-95	24-25	110-114	29-30	129-132	34-35
5230	163-185	43-49	189-201	50-53	204-227	54-60

APPROXIMATE HOURLY CONSUMPTION OF LUBRICANTS

Model	Crankcase		Transmission*		Final Drives**		Hydraulic Control		Coolant		Lubricant Changes	Grease Fittings
	liter	U.S. gal	liter	U.S. gal	liter	U.S. gal	liter	U.S. gal	liter	U.S. gal		
5130B FS	0.364	0.096	0.077	0.020	0.392	0.103	0.600	0.159	0.050	0.013	20	0
5130B ME	0.364	0.096	0.077	0.020	0.392	0.103	0.600	0.159	0.050	0.013	20	2800
5230 FS	0.760	0.200	0.090	0.024	0.499	0.131	0.830	0.169	0.083	0.022	22	0
5230 ME	0.760	0.200	0.090	0.024	0.499	0.131	0.830	0.169	0.083	0.022	22	2800

*Includes pump drives.

**Includes travel drives and swing drives.

†Plus auto lube (see auto lube).

Model	Kg/hr grease	lb/hr grease	Grease canister refills*	Auto lube interval (minutes)	Number of injectors	Grease canister size (lb)
5130B FS	0.34	0.75	13	10	48	120
5130B ME	0.27	0.60	10	10	36	120
5230 FS	0.47	1.04	5	10	48	400
5230 ME	0.33	0.73	4	10	38	400

NOTE: These figures are based on auto lube system as set from the factory.

*Total number of times you can expect to refill the auto lube grease canister in a 2000 hour period.

Factors used (labor)

- hourly labor rate of U.S. \$50.00
- 30 minutes per lube oil change
- 15 minutes per auto lube grease canister refill
- 5 minutes per filter change
- 1 minute per grease fitting

Factors used (materials)

- Lube oils at U.S. 6.35 per U.S. gallon
- Long life coolant at U.S. \$7.00 per U.S. gallon
- Filters at suggested U.S. consumer's list prices.
- Grease at U.S. \$.05 per fitting
- Auto lube grease at U.S. \$3.68 per pound

GUIDE FOR ESTIMATING LOCAL HOURLY COST OF FILTERS

Model	Approx. Hourly Filter Cost	Filters
5130B	0.89	88
5230	1.49	140

QUICK ESTIMATOR TABLE Lube Oils, Filters, Grease

Model	Approx. Cost Per Hour	
	Materials	Labor
5130B FS	6.16	0.57
5130B ME	5.68	1.66
5230 FS	8.83	0.60
5230 ME	7.77	1.76

REPAIRS

Model	Low	Typical	High
5130B	25.00	38.00	53.00
5230	34.00	52.00	73.00

LIFE ADJUSTMENT MULTIPLIERS

0-10,000 hours	0.40
0-20,000	0.80
0-30,000	1.00
0-40,000	1.21
0-60,000	1.25

UNDERCARRIAGE BASIC FACTORS

5130B	13.75
5230	19.00

COST DISTRIBUTION

% parts	70
% labor	30

*Insufficient data.

MATERIAL HANDLING ARRANGEMENTS

CONTENTS

Range dimensions & capacities 4-182

(Scrap specifications and classifications can be found in the Institute of Scrap Iron and Steel Inc.'s "Handbook". The common unit measure for the scrap industry is the gross ton which is 2240 pounds. However, short tons, net tons and metric tons may also be used.)

The versatility of Caterpillar Excavators, plus their ability to be equipped in any number of ways, make them an effective, low cost way to handle scrap and other materials.

NOTE: Contact your Caterpillar Dealer for additional information on equipping Caterpillar Excavators for material handling.

M318 MH/M320 MH Range Diagram

- Caterpillar Material Handling Boom and Stick

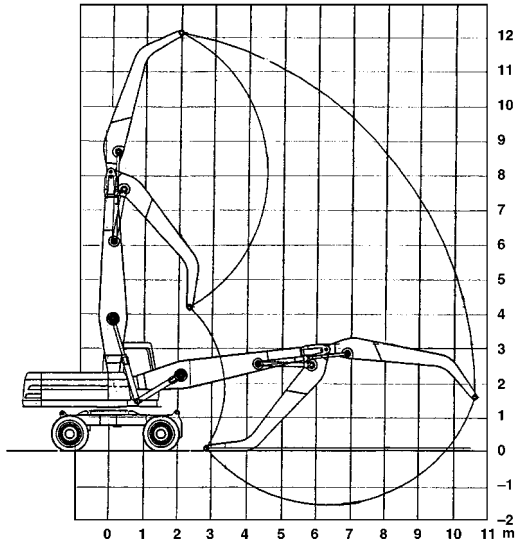

Model	M318 MH		M320 MH	
	m	ft	m	ft
Boom	6.20	20'4"	6.80	22'4"
Stick	4.50	14'9"	4.90	16'1"
Maximum Horizontal Reach	10.60	34'9"	11.60	38'1"
Maximum Vertical Pin Height	12.00	39'4"	12.70	41'8"

Lift Capacities

Equipped with Caterpillar material handling arrangement.

Includes purpose built material handling boom and stick complete with boom foot adapter, wiring and connecting hydraulics, hydraulic cylinders (boom cylinder — 120 mm (4.72") diameter, stick cylinder — 100 mm (3.94") diameter).

Capacities are measured at the bare stick tip.

Capacities are based on level machine equipped as follows:

- Total machine weight including base machine, material handling front, 1.2 m fixed cabraser, wide axles, 2 sets of outriggers, solid tires, 3350 kg (7390 lb) counterweight, lubricants, full fuel tank and operator.

M318 MH — 19 300-20 500 kg (42,550-45,200 lb)

M320 MH — 21 150-22 350 kg (46,630-49,230 lb)

M318 MH

- Stabilizers Raised

Height		3 m 10'0"		4.5 m 15'0"		6 m 20'0"		7.5 m 25'0"		9 m 30'0"		At Max. Reach		Max. Reach Radius	
		Front	Side	Front	Side	Front	Side	Front	Side	Front	Side	Front	Side	m	ft
9.0 m 29'6"	kg lb	—	—	—	—	4300* 9480*	3700 8150	3800* 8370*	2400 5290	—	—	—	—	—	—
7.5 m 24'7"	kg lb	—	—	—	—	5400 11,900	3800 8370	3800 8370	2600 5730	—	—	1700* 3740*	1700* 3740*	8.9	29'2"
6.0 m 19'8"	kg lb	—	—	7800* 17,190*	5800 12,780	5300 11,680	3700 8150	3700 8150	2600 5730	2700 5950	1800 3960	1600* 3520*	1600 3520	9.7	31'10"
4.5 m 14'10"	kg lb	10 400* 22,930*	10 400* 22,930*	8200 18,080	5600 12,340	5100 11,240	3500 7710	3600 7930	2500 5510	2700 5950	1800 3960	1600* 3520*	1400 3080	10.2	33'6"
3.0 m 9'10"	kg lb	—	—	7600 16,750	5000 11,020	4900 10,800	3300 7270	3500 7710	2300 5070	2600 5730	1800 3960	1600* 3520*	1300 2860	10.5	34'5"
1.5 m 4'11"	kg lb	—	—	7000 15,430	4400 9700	4600 10,140	3000 6610	3300 7270	2200 4850	2500 5510	1700 3740	—	—	—	—
0 m 0'	kg lb	3700* 8150*	3700* 8150*	6600 14,550	4100 9040	4400 9700	2800 6170	3200 7050	2100 4630	2500 5510	1600 3520	—	—	—	—
-1.5 m -4'11"	kg lb	—	—	—	—	4100 9040	2700 5950	—	—	—	—	—	—	—	—

*Load limited by hydraulic capacity rather than tipping.

M318 MH

● Stabilizers Lowered

Height		3 m 10'0"		4.5 m 15'0"		6 m 20'0"		7.5 m 25'0"		9 m 30'0"		At Max. Reach		Max. Reach Radius	
		Front	Side	Front	Side	Front	Side	Front	Side	Front	Side	Front	Side	m	ft
9.0 m 29'6"	kg lb	—	—	—	—	4300* 9480*	4300* 9480*	2400* 5290*	2400* 5290*	—	—	—	—	—	—
7.5 m 24'7"	kg lb	—	—	—	—	6300* 13,890*	6300* 13,890*	5100* 11,240*	4800* 10,580*	—	—	1700* 3740*	1700* 3740*	8.9	29'2"
6.0 m 19'8"	kg lb	—	—	7800* 17,190*	7800* 17,190*	6500* 14,330*	6500* 14,330*	5500* 12,120*	4700* 10,360*	4100* 9040*	3500 7710	1600* 3520*	1600* 3520*	9.7	31'10"
4.5 m 14'10"	kg lb	8500* 18,740*	8500* 18,740*	8600* 18,960*	8600* 18,960*	6800* 14,990*	6600 14,550	5700* 12,560*	4600 10,140	4800* 10,580*	3500 7710	1600* 3520*	1600* 3520*	10.2	33'6"
3.0 m 9'10"	kg lb	—	—	9500 20,940	9500 20,940	7200* 15,870*	6300 13,890	5800* 12,780*	4500 9920	4800* 10,580*	3400 7490	1600* 3520*	1600* 3520*	10.5	34'5"
1.5 m 4'11"	kg lb	—	—	10 000* 22,050*	9400 20,720	7400* 16,310*	6000 13,230	5800* 12,780*	4300 9480	4700* 10,360*	3300 7270	—	—	—	—
0 m 0'	kg lb	3700* 8150*	3700* 8150*	9600* 21,160*	9000 19,840	7200* 15,870*	5800 12,780	5600* 12,340*	4200 9260	4300 9480	3200 7050	—	—	—	—
-1.5 m -4'11"	kg lb	—	—	—	—	6400* 14,110*	5000 11,020	—	—	—	—	—	—	—	—

*Load limited by hydraulic capacity rather than tipping.

M320 MH

● **Stabilizers Raised**

Height	4.5 m 15'0"		6 m 20'0"		7.5 m 25'0"		9 m 30'0"		At Max. Reach		Max. Reach Radius	
	Front	Side	Front	Side	Front	Side	Front	Side	Front	Side	m	ft
7.5 m 24'7" kg lb	—	—	6300 13,890	4500 9920	4400 9700	3100 6830	3200 7050	2200 4850	2600 5730	1800 3960	10.10	33'2"
6.0 m 19'6" kg lb	—	—	6200 13,670	4300 9480	4300 9480	3000 6610	3200 7050	2200 4850	2300 5070	1500 3300	10.81	35'6"
4.5 m 14'9" kg lb	9400 20,720	6300 13,890	5900 13,000	4100 9040	4100 9040	2900 6390	3100 6830	2100 4630	2100 4630	1400 3080	11.28	37'0"
3.0 m 9'10" kg lb	8600 18,960	5600 12,340	5500 12,120	3700 8150	3900 8590	2700 5950	3000 6610	2000 4410	2000 4410	1300 2860	11.53	38'4"
1.5 m 4'11" kg lb	7900 17,410	5000 11,020	5100 11,240	3400 7490	3700 8150	2500 5510	2800 6170	1900 4180	—	—	—	—
Ground Line kg lb	7400 16,310	4600 10,140	4900 10,800	3200 7050	3600 7930	2300 5070	2800 6170	1800 3960	—	—	—	—
-1.5 m -4'11" kg lb	—	—	4700 10,360	3000 6610	3500 7710	2200 4850	—	—	—	—	—	—

M320 MH

● **Stabilizers Lowered**

Height	4.5 m 15'0"		6 m 20'0"		7.5 m 25'0"		9 m 30'0"		At Max. Reach		Max. Reach Radius	
	Front	Side	Front	Side	Front	Side	Front	Side	Front	Side	m	ft
7.5 m 24'7" kg lb	—	—	7100* 15,650*	7100* 15,650*	6200* 13,670*	6000 13,230	5400* 11,900*	4500 9920	2800* 6170*	2800* 6170*	10.10	33'2"
6.0 m 19'6" kg lb	—	—	7400* 16,310*	7400* 16,310*	6300* 13,890*	5900 13,000	5500* 12,120*	4400 9700	2800* 6170*	2800* 6170*	10.81	35'6"
4.5 m 14'9" kg lb	10 100* 22,270*	10 100* 22,270*	7900* 17,410*	7900* 17,410*	6500* 14,330*	5800 12,780	5500* 12,120*	4300 9480	2700* 5950*	2700* 5950*	11.28	37'0"
3.0 m 9'10" kg lb	11 200* 24,690*	11 200* 24,690*	8400* 18,520*	7900 17,410	6700* 14,770*	5600 12,340	5600* 12,340*	4200 9260	2800* 6170*	2800* 6170*	11.53	38'4"
1.5 m 4'11" kg lb	11 800* 26,010*	11 800* 26,010*	8600* 18,960*	7500 16,530	6800* 14,990*	5300 11,680	5500* 12,120*	4100 9040	—	—	—	—
Ground Line kg lb	10 800* 23,810*	10 800* 23,810*	8400* 18,520*	7200 15,870	6600* 14,550*	5200 11,460	5200* 11,460*	4000 8820	—	—	—	—
-1.5 m -4'11" kg lb	—	—	7500* 16,530*	7000 15,430	5900* 13,000*	5100 11,240	—	—	—	—	—	—

*Load limited by hydraulic capacity rather than tipping.

- 320B MH
- 325B MH
- 330B MH
- Belgium Sourced

320B MH Range Diagram

- Caterpillar Material Handling Boom and Stick

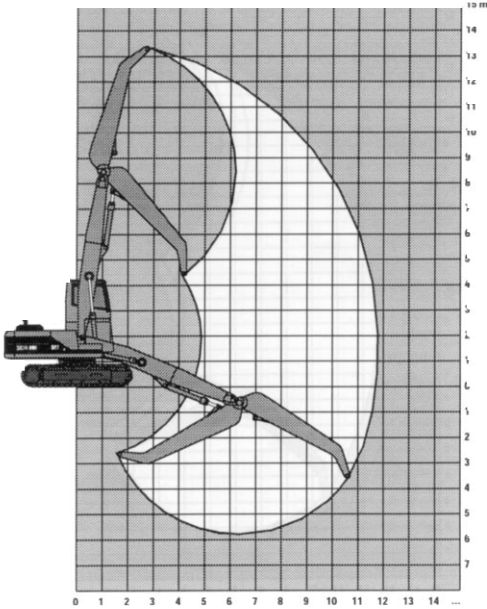

330B MH Range Diagram

- Caterpillar Material Handling Boom and Stick

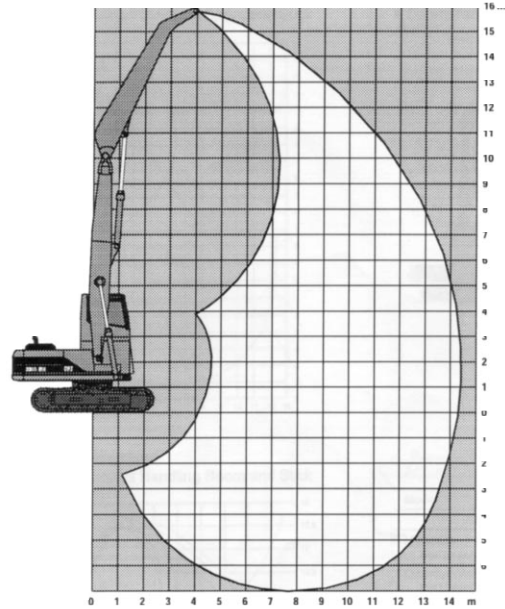

325B MH Range Diagram

- Caterpillar Material Handling Boom and Stick

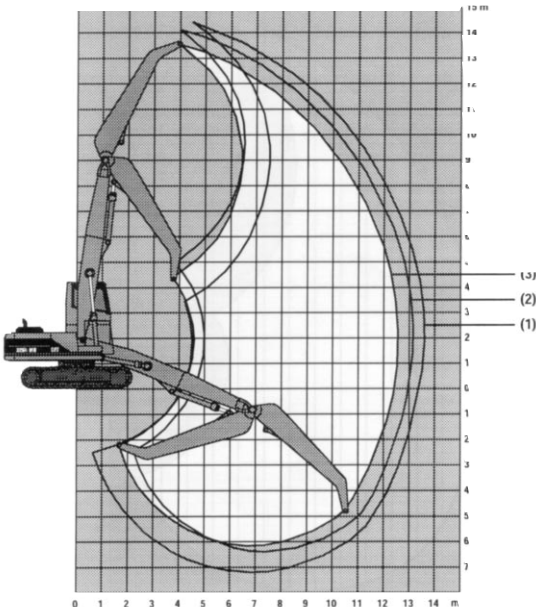

Model	320B MH		330B MH	
	m	ft	m	ft
Boom	6.65	21'10"	7.77	25'6"
Stick	5.40	17'9"	6.83	22'5"
Maximum Horizontal Reach	12.40	40'3"	14.37	47'1"
Maximum Vertical Pin Height	13.60	44'6"	15.78	51'9"

Model	325B MH					
	1		2		3	
	m	ft	m	ft	m	ft
Boom	7.20	23'7"	7.80	25'7"	7.20	23'7"
Stick	6.35	20'10"	5.35	17'7"	5.35	17'7"
Maximum Horizontal Reach	13.40	44'0"	12.90	42'4"	12.40	40'8"
Maximum Vertical Pin Height	14.60	47'11"	14.00	45'11"	13.50	44'3"

NOTE: All Material Handling Arrangements require extra wide gage, reinforced upper frame and additional counter weight.

Lift Capacities

Equipped with Caterpillar material handling arrangement.

Includes purpose built material handling boom and stick, wiring and connecting hydraulics, hydraulic cylinders and heavier counterweight. Boom cylinder — 140 mm (5.5") diameter stick cylinder — 150 mm (5.9") diameter.

Capacities are measured at the bare stick tip, and are expressed in kg.

Capacities are based on level machine equipped as follows:

- Total machine weight including base machine, material handling front, 1.2 m fixed cabriser, wide gage undercarriage, counterweight, lubricants, full fuel tank and operator.
- 600 mm (2'0") triple grouser shoes.

320B MH — Heavy Duty Square Undercarriage configuration

Maximum reach, height and lift capacity (6.65 m boom and 5.4 m stick)

Height	3 m		4.5 m		6 m		7.5 m		Max. Reach Radius	
	Front	Side	Front	Side	Front	Side	Front	Side		
12.0 m	kg	—	—	—	6233*	6233*	—	—	6.46 m	
10.5 m	kg	—	—	—	7627*	7627*	6161*	6161*	8.37 m	
9.0 m	kg	—	—	—	—	—	6979*	6531	9.69 m	
7.5 m	kg	—	—	—	—	—	6972*	6511	10.63 m	
6.0 m	kg	—	—	—	8164*	8164*	7173*	6390	11.29 m	
4.5 m	kg	—	—	9215*	9215*	8848*	8848*	7070	6186	11.73 m
3.0 m	kg	—	—	12 551*	12 551*	9652*	8390	6803	5927	11.96 m
1.5 m	kg	—	—	13 903*	12 366	9166	7894	6524	5657	12.00 m
Ground	kg	—	—	11 336*	11 336*	8746	7491	6285	5425	11.84 m
-1.5 m	kg	3656*	3656*	8933*	8933*	8484	7239	6122	5266	11.49 m
-3.0 m	kg	4990*	4990*	9408*	9408*	8375	7135	6047	5194	10.52 m
-4.5 m	kg	—	—	—	—	6295*	6295*	4887*	4887*	7.68 m

Height	9 m		10.5 m		At Max. Reach		Max. Reach Radius	
	Front	Side	Front	Side	Front	Side		
12.0 m	kg	—	—	—	5124*	5124*	6.46 m	
10.5 m	kg	—	—	—	4190*	4190*	8.37 m	
9.0 m	kg	5418	4755	—	—	3741*	3741*	9.69 m
7.5 m	kg	5451	4786	4043*	3612	3494*	3494*	10.63 m
6.0 m	kg	5392	4728	4153	3626	3362*	3159	11.29 m
4.5 m	kg	5274	4614	4101	3576	3308*	2939	11.73 m
3.0 m	kg	5123	4466	4021	3497	3255	2818	11.96 m
1.5 m	kg	4964	4311	3933	3411	3212	2778	12.00 m
Ground	kg	4824	4175	3859	3338	3255	2813	11.84 m
-1.5 m	kg	4728	4080	3816	3296	3195*	2934	11.49 m
-3.0 m	kg	4692	4045	3326*	3308	3297*	3297*	10.52 m
-4.5 m	kg	—	—	—	—	4716*	4716*	7.68 m

*Limited by hydraulic rather than tipping load.

The above loads are in compliance with hydraulic excavator lift capacity ratings standard ISO 10567, they do not exceed 87% of hydraulic lifting capacity or 75% of tipping capacity. Weight of all lifting accessories must be deducted from the above lifting capacities.

320B MH — Heavy Duty High Undercarriage configuration

Maximum reach and height but less lift capacity (6.65 m boom and 5.4 m stick). To be used when shipping width is limited.

Height		3 m		4.5 m		6 m		7.5 m		Max. Reach Radius
		Front	Side	Front	Side	Front	Side	Front	Side	
12.0 m	kg	—	—	—	—	6233*	6233*	—	—	6.46 m
10.5 m	kg	—	—	—	—	7627*	7627*	6161*	5248	8.37 m
9.0 m	kg	—	—	—	—	—	—	6979*	5363	9.69 m
7.5 m	kg	—	—	—	—	—	—	6972*	5344	10.63 m
6.0 m	kg	—	—	—	—	8164*	7520	7173*	5229	11.29 m
4.5 m	kg	—	—	9215*	9215*	8848*	7182	7035	5034	11.73 m
3.0 m	kg	—	—	12 551*	10 542*	9636	6735	6768	4786	11.96 m
1.5 m	kg	—	—	13 903*	9570	9120	6268	6490	4528	12.00 m
Ground	kg	—	—	11 336*	8875	8700	5889	6251	4307	11.84 m
-1.5 m	kg	3656*	3656*	8933*	8528	8437	5651	6087	4155	11.49 m
-3.0 m	kg	4990*	4990*	9408*	8433	8328	5553	6012	4086	10.52 m
-4.5 m	kg	—	—	—	—	6295*	5577	4887*	4104	7.68 m

Height		9 m		10.5 m		At Max. Reach		Max. Reach Radius
		Front	Side	Front	Side	Front	Side	
12.0 m	kg	—	—	—	—	5124*	5124*	6.46 m
10.5 m	kg	—	—	—	—	4190*	4190*	8.37 m
9.0 m	kg	5391	3880	—	—	3741*	3339	9.69 m
7.5 m	kg	5424	3910	4043*	2915	3494*	2835	10.63 m
6.0 m	kg	5365	3855	4131	2929	3362*	2530	11.29 m
4.5 m	kg	5247	3744	4079	2880	3308*	2343	11.73 m
3.0 m	kg	5096	3601	3999	2804	3236	2238	11.96 m
1.5 m	kg	4936	3451	3912	2721	3193	2200	12.00 m
Ground	kg	4797	3321	3837	2649	3236	2226	11.84 m
-1.5 m	kg	4701	3230	3793	2608	3195*	2324	11.49 m
-3.0 m	kg	4665	3195	3326*	2620	3297*	2615	10.52 m
-4.5 m	kg	—	—	—	—	4716*	3976	7.68 m

*Limited by hydraulic rather than tipping load.

The above loads are in compliance with hydraulic excavator lift capacity ratings standard ISO 10567, they do not exceed 87% of hydraulic lifting capacity or 75% of tipping capacity. Weight of all lifting accessories must be deducted from the above lifting capacities.

Lift Capacities

Equipped with Caterpillar material handling arrangement.

Includes purpose built material handling boom and stick, wiring and connecting hydraulics, hydraulic cylinders (boom cylinder — 140 mm (5.5") diameter, stick cylinder — 170 mm (7") diameter).

Capacities are measured at the bare stick tip, and are expressed in kg.

Capacities are based on level machine equipped as follows:

- Total machine weight including base machine, material handling front, 1.2 m fixed cabriser, wide gage undercarriage, counterweight, lubricants, full fuel tank and operator.
- 800 mm (2'8") triple grouser shoes.

325B MH — Standard configuration (1)

Maximum reach, height and lift capacity (7.2 m boom and 6.35 m stick)

Height	3 m		4.5 m		6 m		7.5 m		Max. Reach Radius	
	Front	Side	Front	Side	Front	Side	Front	Side		
13.5 m	kg	—	—	—	—	—	—	—	6.94 m	
12.0 m	kg	—	—	—	—	—	6751*	6751*	8.98 m	
10.5 m	kg	—	—	—	—	—	—	—	10.42 m	
9.0 m	kg	—	—	—	—	—	—	—	11.47 m	
7.5 m	kg	—	—	—	—	—	—	—	12.26 m	
6.0 m	kg	—	—	—	—	—	6771*	6771*	12.82 m	
4.5 m	kg	—	—	—	—	8413*	8413*	7347*	7347*	13.18 m
3.0 m	kg	—	—	12 309*	12 309*	9629*	9629*	8014*	7543	13.36 m
1.5 m	kg	—	—	14 524*	14 524*	10 744*	9945	8617*	7196	13.37 m
Ground	kg	—	—	12 855*	12 855*	11 420*	9434	8889	6894	13.21 m
-1.5 m	kg	4204*	4204*	10 392*	10 392*	11 470*	9099	8658	6676	12.88 m
-3.0 m	kg	6043*	6043*	11 133*	11 133*	10 847*	8934	8529	6554	12.35 m
-4.5 m	kg	7956*	7956*	12 210*	12 210*	9533*	8908	7586*	6527	11.60 m
-6.0 m	kg	—	—	9210*	9210*	7447*	7447*	5924*	5924*	10.23 m

Height	9 m		10.5 m		12 m		At Max. Reach		Max. Reach Radius	
	Front	Side	Front	Side	Front	Side	Front	Side		
13.5 m	kg	—	—	—	—	—	7823*	7823*	6.94 m	
12.0 m	kg	—	—	—	—	—	6536*	6078	8.98 m	
10.5 m	kg	6078*	6078*	—	—	—	5894*	4820	10.42 m	
9.0 m	kg	5937*	5937*	5676*	4846	—	5182	4115	11.47 m	
7.5 m	kg	5999*	5999*	5648*	4839	4830	3828	4647	3674	12.26 m
6.0 m	kg	6217*	6117	5741*	4773	4817	3815	4302	3388	12.82 m
4.5 m	kg	6544*	5946	5880	4670	4763	3762	4085	3207	13.18 m
3.0 m	kg	6913*	5741	5750	4544	4689	3691	3966	3105	13.36 m
1.5 m	kg	7038	5531	5615	4414	4611	3617	3930	3070	13.37 m
Ground	kg	6843	5344	5495	4299	4545	3552	3975	3102	13.21 m
-1.5 m	kg	6696	5204	5406	4214	4503	3512	4028*	3207	12.88 m
-3.0 m	kg	6612	5124	5364	4173	4159*	3516	3672*	3403	12.35 m
-4.5 m	kg	6037*	5113	4593*	4191	—	—	3164*	3164*	11.60 m
-6.0 m	kg	4466*	4466*	—	—	—	—	3017*	3017*	10.23 m

*Limited by hydraulic rather than tipping load.

The above loads are in compliance with hydraulic excavator lift capacity ratings standard ISO 10567, they do not exceed 87% of hydraulic lifting capacity or 75% of tipping capacity. Weight of all lifting accessories must be deducted from the above lifting capacities.

325B MH — Optional configuration (2)

More dump height close at machine with the same reach (7.8 m boom and 5.35 m stick)

Height		3 m		4.5 m		6 m		7.5 m		Max. Reach Radius
		Front	Side	Front	Side	Front	Side	Front	Side	
13.5 m	kg	—	—	—	—	8952*	8952*	—	—	6.17 m
12.0 m	kg	—	—	—	—	—	—	7291*	7291*	8.40 m
10.5 m	kg	—	—	—	—	—	—	6934*	6934*	9.92 m
9.0 m	kg	—	—	—	—	—	—	6902*	6902*	11.03 m
7.5 m	kg	—	—	—	—	—	—	7110*	7110*	11.84 m
6.0 m	kg	—	—	—	—	8713*	8713*	7513*	7513*	12.42 m
4.5 m	kg	—	—	12 440*	12 440*	9683*	9683*	8037*	7566	12.79 m
3.0 m	kg	—	—	—	—	10 667*	9961	8559*	7224	12.98 m
1.5 m	kg	—	—	—	—	11 324*	9408	8903	6906	12.99 m
Ground	kg	—	—	5604*	5604*	11 404*	9030	8643	6661	12.83 m
-1.5 m	kg	—	—	7022*	7022*	10 861*	8836	8485	6512	12.48 m
-3.0 m	kg	5454*	5454*	9104*	9104*	9732*	8788	7885*	6456	11.93 m
-4.5 m	kg	—	—	9516*	9516*	8024*	8024*	6606*	6488	11.16 m
-6.0 m	kg	—	—	—	—	5654*	5654*	4676*	4676*	8.94 m

Height		9 m		10.5 m		12 m		At Max. Reach		Max. Reach Radius
		Front	Side	Front	Side	Front	Side	Front	Side	
13.5 m	kg	—	—	—	—	—	—	8870*	8870*	6.17 m
12.0 m	kg	—	—	—	—	—	—	7067*	6663	8.40 m
10.5 m	kg	6464*	6113	—	—	—	—	6276*	5141	9.92 m
9.0 m	kg	6352*	6145	5925*	4740	—	—	5458	4329	11.03 m
7.5 m	kg	6435*	6079	5896*	4734	—	—	4856	3836	11.84 m
6.0 m	kg	6645*	5944	5877	4665	4743	3743	4475	3522	12.42 m
4.5 m	kg	6926*	5762	5766	4560	4695	3696	4239	3324	12.79 m
3.0 m	kg	7068	5558	5640	4437	4628	3631	4110	3215	12.98 m
1.5 m	kg	6866	5364	5517	4320	4560	3567	4073	3180	12.99 m
Ground	kg	6702	5208	5417	4223	4509	3517	4126	3218	12.83 m
-1.5 m	kg	6595	5106	5355	4163	4491	3499	4015*	3337	12.48 m
-3.0 m	kg	6415*	5067	5122*	4151	—	—	3586*	3560	11.93 m
-4.5 m	kg	5294*	5098	3881*	3881*	—	—	2970*	2970*	11.16 m
-6.0 m	kg	—	—	—	—	—	—	3506*	3506*	8.94 m

*Limited by hydraulic rather than tipping load.

The above loads are in compliance with hydraulic excavator lift capacity ratings standard ISO 10567, they do not exceed 87% of hydraulic lifting capacity or 75% of tipping capacity. Weight of all lifting accessories must be deducted from the above lifting capacities.

325B MH — Optional configuration (3)

Allows more lift capacity but less maximum reach (7.2 m boom and 5.35 m stick)

Height		3 m		4.5 m		6 m		7.5 m		Max. Reach Radius
		Front	Side	Front	Side	Front	Side	Front	Side	
13.5 m	kg	—	—	—	—	—	—	—	—	4.77 m
12.0 m	kg	—	—	—	—	—	—	—	—	7.45 m
10.5 m	kg	—	—	—	—	—	—	7222*	7222*	9.13 m
9.0 m	kg	—	—	—	—	—	—	7054*	7054*	10.32 m
7.5 m	kg	—	—	—	—	—	—	7184*	7184*	11.19 m
6.0 m	kg	—	—	—	—	8548*	8548*	7551*	7551*	11.80 m
4.5 m	kg	—	—	11 837*	11 837*	9532*	9532*	8082*	7722	12.19 m
3.0 m	kg	—	—	14 086*	14 086*	10 621*	10 279	8652*	7424	12.39 m
1.5 m	kg	—	—	14 966*	14 904	11 646*	9765	9094*	7136	12.40 m
Ground	kg	—	—	9229*	9229*	11 749*	9390	8892	6906	12.23 m
-1.5 m	kg	4309*	4309*	9810*	9810*	11 351*	9181	8738	6761	11.86 m
-3.0 m	kg	6770*	6770*	11 753*	11 753*	10 258*	9117	8184*	6705	11.29 m
-4.5 m	kg	—	—	10 348*	10 348*	8436*	8436*	6768*	6738	10.46 m
-6.0 m	kg	—	—	—	—	—	—	—	—	7.08 m

Height		9 m		10.5 m		12 m		At Max. Reach		Max. Reach Radius
		Front	Side	Front	Side	Front	Side	Front	Side	
13.5 m	kg	—	—	—	—	—	—	10 985*	10 985*	4.77 m
12.0 m	kg	—	—	—	—	—	—	7922*	7922*	7.45 m
10.5 m	kg	6898*	6050	—	—	—	—	6887*	5896	9.13 m
9.0 m	kg	6611*	6150	—	—	—	—	6102	4865	10.32 m
7.5 m	kg	6618*	6124	5976	4769	—	—	5368	4269	11.19 m
6.0 m	kg	6794*	6025	5937	4731	—	—	4918	3899	11.80 m
4.5 m	kg	7068*	5877	5854	4651	4764	3769	4644	3672	12.19 m
3.0 m	kg	7211	5703	5751	4551	4719	3726	4499	3549	12.39 m
1.5 m	kg	7032	5532	5647	4452	4672	3681	4461	3515	12.40 m
Ground	kg	6884	5391	5562	4371	4641	3650	4527	3562	12.23 m
-1.5 m	kg	6788	5299	5514	4323	—	—	4400*	3707	11.86 m
-3.0 m	kg	6551*	5268	5022*	4327	—	—	3924*	3924*	11.29 m
-4.5 m	kg	5213*	5213*	—	—	—	—	3218*	3218*	10.46 m
-6.0 m	kg	—	—	—	—	—	—	4858*	4858*	7.08 m

*Limited by hydraulic rather than tipping load.

The above loads are in compliance with hydraulic excavator lift capacity ratings standard ISO 10567, they do not exceed 87% of hydraulic lifting capacity or 75% of tipping capacity. Weight of all lifting accessories must be deducted from the above lifting capacities.

Lift Capacities

Equipped with Caterpillar material handling arrangement.

Includes purpose built material handling boom and stick, wiring and connecting hydraulics, hydraulic cylinders (boom cylinder — 150 mm (5.9") diameter, stick cylinder — 170 mm (6.7") diameter).

Capacities are measured at the bare stick tip, and are expressed in kg.

Capacities are based on level machine equipped as follows:

- Total machine weight including base machine, material handling front, 1.2 m fixed cabriser, wide gage undercarriage, counterweight, lubricants, full fuel tank and operator.
- 750 mm (2'6") triple grouser shoes.

330B MH

Maximum reach, height and lift capacity (7.8 m boom and 6.8 m stick)

Height		3 m		4.5 m		6 m		7.5 m		9 m		Max. Reach Radius
		Front	Side	Front	Side	Front	Side	Front	Side	Front	Side	
15.0 m	kg	—	—	—	—	9198*	9198*	—	—	—	—	6.64 m
13.5 m	kg	—	—	—	—	—	—	7676*	7676*	—	—	8.97 m
12.0 m	kg	—	—	—	—	—	—	—	—	6765*	6765*	10.59 m
10.5 m	kg	—	—	—	—	—	—	—	—	6543*	6543*	11.80 m
9.0 m	kg	—	—	—	—	—	—	—	—	6533*	6533*	12.72 m
7.5 m	kg	—	—	—	—	—	—	—	—	6698*	6698*	13.40 m
6.0 m	kg	—	—	—	—	—	—	7733*	7733*	7006*	7006*	13.89 m
4.5 m	kg	—	—	—	—	9808*	9808*	8420*	8420*	7408*	7408*	14.21 m
3.0 m	kg	—	—	—	—	11 155*	11 155*	9167*	9167*	7834*	7589	14.36 m
1.5 m	kg	—	—	—	—	12 312*	12 312*	9808*	9456	8188*	7290	14.35 m
Ground	kg	—	—	7670*	7670*	12 943*	12 355	10 178*	9042	8372*	7026	14.18 m
-1.5 m	kg	2864*	2864*	7237*	7237*	12 901*	11 910	10 158*	8742	8298*	6826	13.85 m
-3.0 m	kg	4569*	4569*	8312*	8312*	12 177*	11 684	9677*	8568	7884*	6703	13.34 m
-4.5 m	kg	6320*	6320*	9933*	9933*	10 787*	10 787*	8679*	8511	7043*	6664	12.63 m
-6.0 m	kg	—	—	10 626*	10 626*	8691*	8691*	7071*	7071*	5637*	5637*	11.43 m

Height		10.5 m		12 m		13.5 m		At Max. Reach		Max. Reach Radius
		Front	Side	Front	Side	Front	Side	Front	Side	
15.0 m	kg	—	—	—	—	—	—	8224*	8224*	6.64 m
13.5 m	kg	—	—	—	—	—	—	6690*	6690*	8.97 m
12.0 m	kg	6171*	6171*	—	—	—	—	5951*	5951*	10.59 m
10.5 m	kg	6233*	6233*	—	—	—	—	5527*	5298	11.80 m
9.0 m	kg	6164*	6164*	5832*	5216	—	—	5273*	4672	12.72 m
7.5 m	kg	6234*	6234*	5816*	5204	—	—	5130*	4258	13.40 m
6.0 m	kg	6401*	6384	5879*	5138	5370*	4197	5068*	3980	13.89 m
4.5 m	kg	6625*	6219	5978*	5037	5370	4152	4936	3801	14.21 m
3.0 m	kg	6855*	6029	6070*	4919	5304	4088	4818	3699	14.36 m
1.5 m	kg	7027*	5838	6109*	4798	5235	4021	4637*	3668	14.35 m
Ground	kg	7073*	5667	6034*	4692	5030*	3967	4412*	3705	14.18 m
-1.5 m	kg	6919*	5538	5773*	4615	4550*	3941	4137*	3817	13.85 m
-3.0 m	kg	6482*	5460	5221*	4581	—	—	3780*	3780*	13.34 m
-4.5 m	kg	5644*	5448	4176*	4176*	—	—	3288*	3288*	12.63 m
-6.0 m	kg	4186*	4186*	—	—	—	—	3031*	3031*	11.43 m

*Limited by hydraulic rather than tipping load.

The above loads are in compliance with hydraulic excavator lift capacity ratings standard ISO 10567, they do not exceed 87% of hydraulic lifting capacity or 75% of tipping capacity. Weight of all lifting accessories must be deducted from the above lifting capacities.

325B MH Range Diagram

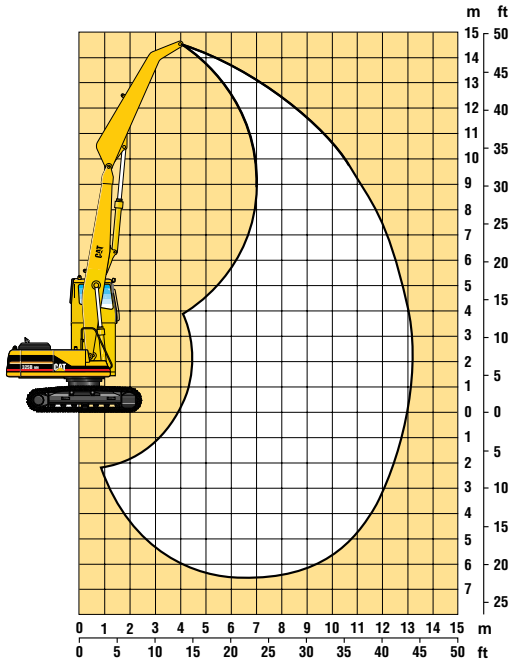

330B MH Range Diagram

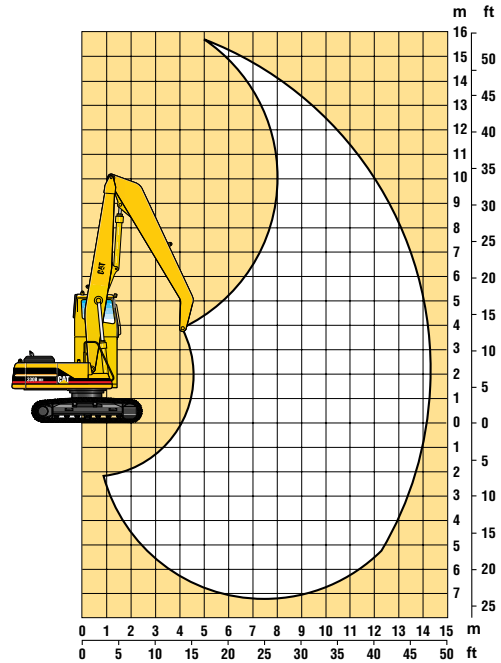

Model	325B MH		330B MH	
	m	ft	m	ft
MH Two-Piece Front	13.40	43'11"	14.40	47'3"
Maximum Reach @ 1.5 m (5'0")	13.40	43'11"	14.40	47'3"
Maximum Height @ 5.09 m (16'8")	14.80	48'7"	15.65	51'4"
Track Shoe	800 mm	2'8"	850 mm	2'10"

325B MH

Equipped with Cat two-piece, 13.4 m (43'11") Front, 800 mm (27.5") triple grouser shoes

Height		1.5 m 5'0"		3 m 10'0"		4.5 m 15'0"		6 m 20'0"		7.5 m 25'0"		Max. Reach Radius	
		Front	Side	Front	Side	Front	Side	Front	Side	Front	Side	m	ft
15.0 m 45'0"	kg lb	—	—	—	—	—	—	18,600*	18,600*	—	—	—	21.43
12.0 m 40'0"	kg lb	—	—	—	—	—	—	—	—	6700*	6700*	8.96	28.68
10.5 m 35'0"	kg lb	—	—	—	—	—	—	—	—	6300*	6300*	10.40	33.67
9.0 m 30'0"	kg lb	—	—	—	—	—	—	—	—	6300*	6300*	11.46	37.32
7.5 m 25'0"	kg lb	—	—	—	—	—	—	—	—	6400*	6400*	12.25	40.02
6.0 m 20'0"	kg lb	—	—	—	—	—	—	—	—	14,300*	14,300*	12.81	41.94
4.5 m 15'0"	kg lb	—	—	—	—	—	—	8500*	8500*	7400*	7400*	13.18	43.19
3.0 m 10'0"	kg lb	—	—	—	—	12 300*	12 300*	9700*	9700*	8100*	7700	13.37	43.84
1.5 m 5'0"	kg lb	—	—	—	—	26,800*	26,800*	21,000*	21,000*	17,600*	16,700	13.38	43.90
0.0 m 0'	kg lb	—	—	—	—	—	—	10 800*	10 200*	8700*	7400	13.22	43.39
-1.5 m -5'0"	kg lb	—	—	4100*	4100*	10 300*	10 300*	11 500*	9400	9000	6900	12.89	42.27
-3.0 m -10'0"	kg lb	—	—	6000*	6000*	11 000*	11 000*	10 900*	9200	8600*	6800	12.36	40.50
-4.5 m -15'0"	kg lb	9100*	9100*	13,700*	13,700*	25,400*	25,400*	23,800*	19,800	18,800*	14,600	11.62	37.98
-6.0 m -20'0"	kg lb	—	—	7900*	7900*	12 300*	12 300*	9600*	9200	7600*	6700	—	—
				18,000*	18,000*	26,900*	26,900*	20,900*	19,700*	16,600*	14,500		
				—	20,100*	20,100*	16,200*	16,200*	12,800*	12,800*	9500*		

Height		9 m 30'0"		10.5 m 35'0"		12 m 40'0"		At Max. Reach		Max. Reach Radius	
		Front	Side	Front	Side	Front	Side	Front	Side	m	ft
15.0 m 45'0"	kg lb	—	—	—	—	—	—	18,300*	18,300*	—	21.43
12.0 m 40'0"	kg lb	—	—	—	—	—	—	6600*	6200	8.96	28.68
10.5 m 35'0"	kg lb	6100*	6100*	—	—	—	—	14,900*	14,300	10.40	33.67
9.0 m 30'0"	kg lb	13,600*	13,600*	5900*	5000	—	—	13,400*	11,200	11.46	37.32
7.5 m 25'0"	kg lb	6000*	6000*	5700*	5000	—	—	5400	4300	12.25	40.02
6.0 m 20'0"	kg lb	13,500*	13,500*	12,800*	10,700	10,800	8500	12,100	9500	12.81	41.94
4.5 m 15'0"	kg lb	6300*	6300*	5800*	4900	5000	4000	13,400*	13,400*	13.18	43.19
3.0 m 10'0"	kg lb	13,800*	13,500	12,800*	10,600	10,800	8500	4300	3300	13.37	43.84
1.5 m 5'0"	kg lb	6600*	6100	6000*	4800	5000	3900	4200	3200	13.38	43.90
0.0 m 0'	kg lb	14,400*	13,200	13,100*	10,400	10,700	8400	4100	3200	13.22	43.39
-1.5 m -5'0"	kg lb	7000	5900	6000	4700	4900	3800	9100	7100	12.89	42.27
-3.0 m -10'0"	kg lb	15,800	12,700	12,900	10,100	10,600	8200	4200	3200	12.36	40.50
-4.5 m -15'0"	kg lb	7300*	5700	5900	4600	4800	3800	3700*	3500	11.62	37.98
-6.0 m -20'0"	kg lb	15,400	11,900	12,400	9600	10,300	8000	9200	7100	—	—
		7000	5400	5700	4400	4700	3700	4100*	3300		
		15,100	11,600	12,200	9400	10,200	7900	9000*	7400		
		6900	5300	5600	4300	4200*	3700	8200*	7800		
		14,900	11,400	12,100	9400	8800*	7900	3700*	3500		
		6100*	5300	4600*	4400	—	—	7100*	7100*		
		13,200*	11,400	9900*	9400	—	—	—	—		
		9500*	—	—	—	—	—	—	—		

*Indicates that the load is limited by hydraulic capacity rather than tipping capacity. Lift capacity ratings are based on SAE standard J1097. Rated loads do not exceed 87% of hydraulic lifting capacity or 75% of tipping capacity.

330B MH

Equipped with Cat two-piece, 14.4 m (47'3") Front, 850 mm triple grouser shoes

Height		3 m 10'0"		4.5 m 15'0"		6 m 20'0"		7.5 m 25'0"		9 m 30'0"		Max. Reach Radius	
		Front	Side	Front	Side	Front	Side	Front	Side	Front	Side	m	ft
13.5 m 46'0"	kg lb	—	—	—	—	—	—	7600* 17,200*	7600* 17,200*	—	—	8.93	26.37
12.0 m 40'0"	kg lb	—	—	—	—	—	—	—	—	6700* 15,000*	6700* 15,000*	10.56	34.05
10.5 m 35'0"	kg lb	—	—	—	—	—	—	—	—	6500* 14,800*	6500* 14,800*	11.78	38.25
9.0 m 30'0"	kg lb	—	—	—	—	—	—	—	—	6500* 14,600*	6500* 14,600*	12.70	41.41
7.5 m 25'0"	kg lb	—	—	—	—	—	—	—	—	6700* 14,800*	6700* 14,800*	13.39	43.76
6.0 m 20'0"	kg lb	—	—	—	—	—	—	7700* 17,000*	7700* 17,000*	7000* 15,400*	7000* 15,400*	13.89	45.47
4.5 m 15'0"	kg lb	—	—	—	—	9800* 21,300*	9800* 21,300*	8400* 18,400*	8400* 18,400*	7400* 16,200*	7400* 16,200*	14.21	46.57
3.0 m 10'0"	kg lb	—	—	—	—	11 200* 24,300*	11 200* 24,300*	9200* 20,000*	9200* 20,000*	7900* 17,100*	7700* 16,600*	14.36	47.10
1.5 m 5'0"	kg lb	—	—	—	—	12 300* 26,800*	12 300* 26,800*	9800* 21,400*	9600* 20,600*	8200* 17,900*	7400* 16,000*	14.35	47.10
0.0 m 0'	kg lb	—	—	7600* 18,800*	7600* 18,800*	13 000* 26,200*	12 500* 26,800*	10 200* 22,200*	9200* 19,700*	8400* 18,300*	7100* 15,400*	14.19	46.55
-1.5 m -5'0"	kg lb	2900* 6800*	2900* 6800*	7200* 17,000*	7200* 17,000*	12 900* 28,000*	12 000* 25,900*	10 200* 22,100*	8900* 19,100*	8300* 18,100*	6900* 15,000*	13.86	45.45
-3.0 m -10'0"	kg lb	4600* 10,600*	4600* 10,600*	8300* 19,200*	8300* 19,200*	12 200* 26,300*	11 800* 25,400*	9700* 21,100*	8700* 18,700*	7900* 17,200*	6800* 14,700*	13.35	43.75
-4.5 m -15'0"	kg lb	6300* 14,400*	6300* 14,400*	9900* 22,700*	9900* 22,700*	10 800* 23,600*	10 800* 23,600*	8700* 18,900*	8600* 18,600*	7100* 15,300*	6800* 14,600*	12.65	41.37
-6.0 m -20'0"	kg lb	—	—	10 600* 23,200*	10 600* 23,200*	8700* 18,900*	8700* 18,900*	7100* 15,300*	7100* 15,300*	5600* 12,100*	5600* 12,100*	—	—

Height		10.5 m 35'0"		12 m 40'0"		13.5 m 46'0"		At Max. Reach		Max. Reach Radius	
		Front	Side	Front	Side	Front	Side	Front	Side	m	ft
13.5 m 46'0"	kg lb	—	—	—	—	—	—	6600* 15,200*	6600* 15,200*	8.93	26.37
12.0 m 40'0"	kg lb	6000* —	6000* —	—	—	—	—	5900* 13,300*	5900* 13,300*	10.56	34.05
10.5 m 35'0"	kg lb	6200* 14,100*	6200* 14,100*	—	—	—	—	5500* 12,200*	5400* 12,100*	11.78	38.25
9.0 m 30'0"	kg lb	6200* 13,700*	6200* 13,700*	5800* 13,000*	5300* 11,300*	—	—	5200* 11,600*	4800* 10,600*	12.70	41.41
7.5 m 25'0"	kg lb	6200* 13,800*	6200* 13,800*	5800* 12,900*	5300* 11,400*	—	—	5100* 11,300*	4400* 9600*	13.39	43.76
6.0 m 20'0"	kg lb	6400* 14,100*	6400* 13,900*	5900* 12,900*	5200* 11,200*	5400* 11,800*	4300* 9200*	5000* 11,100*	4100* 9000*	13.89	45.47
4.5 m 15'0"	kg lb	6600* 14,500*	6300* 13,600*	6000* 13,100*	5100* 11,000*	5400* 11,700*	4200* 9100*	5000* 11,100*	3900* 8600*	14.21	46.57
3.0 m 10'0"	kg lb	6900* 15,000*	6100* 13,200*	6100* 13,300*	5000* 10,800*	5400* 11,700*	4200* 9000*	4900* 10,800*	3800* 8300*	14.36	47.10
1.5 m 5'0"	kg lb	7100* 15,400*	5900* 12,800*	6100* 13,400*	4900* 10,500*	5300* 11,400*	4100* 8800*	4700* 10,400*	3800* 8300*	14.35	47.10
0.0 m 0'	kg lb	7100* 15,400*	5800* 12,400*	6100* 13,200*	4800* 10,300*	5100* 10,900*	4100* 8700*	4400* 9900*	3800* 8400*	14.19	46.55
-1.5 m -5'0"	kg lb	6900* 15,100*	5600* 12,200*	5800* 12,500*	4700* 10,200*	4600* 9600*	4000* 8700*	4200* 9200*	3900* 8600*	13.86	45.45
-3.0 m -10'0"	kg lb	6500* 14,100*	5600* 12,000*	5200* 11,200*	4700* 10,100*	—	—	3800* 8400*	3800* 8400*	13.35	43.75
-4.5 m -15'0"	kg lb	5700* 12,200*	5600* 12,000*	4200* 8700*	4200* 8700*	—	—	3300* 7300*	3300* 7300*	12.65	41.37
-6.0 m -20'0"	kg lb	4200* 8800*	4200* 8800*	—	—	—	—	—	—	—	—

*Indicates that the load is limited by hydraulic capacity rather than tipping capacity. Lift capacity ratings are based on SAE standard J1097. Rated loads do not exceed 87% of hydraulic lifting capacity or 75% of tipping capacity.

BACKHOE LOADERS

CONTENTS

Features	5-1
Specifications	5-2
Tires	5-4
Backhoe Loader Performance Data	5-6
Backhoe Bucket Capacities	5-21
Backhoe Lifting Capacities	5-22
Machine Dimensions	5-28
Special Attachments	5-29

Features:

- **416C/426C/436C/446B** — center pivot backhoe design.
- **428C/438C** — side shift backhoe design.
- **Standard single-tilt loader ...** features divergent loader arms, a narrow loader tower and single bucket tilt cylinder for improved visibility.
- **Optional integrated toolcarrier (IT) loader ...** offers maximum lift and breakout forces, divergent loader arms, and parallel lift for efficient loading and material handling.
 - **Hydraulic Quick Coupler ...** allows a wide range of selected attachments, including those available for Cat integrated toolcarriers.
- **Excavator-style backhoe ...** provides enhanced visibility even with narrow buckets, ability to reach over obstacles, and faster, easier truck loading.
- **Load-sensing hydraulic system ...** provides full hydraulic power to implements at all engine speeds, low fuel consumption, smooth control and low lever efforts.
- **All wheel steer ...** is available on the 426C, 436C, and 438C. Full hydrostatic steering with three operator selected modes. Two wheel steer, circle steer, and independent rear maneuvering for the tightest turning circle in the industry.
- **4F/4R fully synchronized gear box ...** provides on-the-go shifting in all gears and on-the-go engagement of optional all wheel drive.

- **Power-Shift transmission standard on 446B and available as an option on C-Series ...** for operator comfort and efficiency.
- **Brakes ...** are oil immersed, multi-disc and self adjusting for long service life. Hydraulic assist allows low pedal effort.
- **E-Stick wear pads ...** are field replaceable and can be shimmed independently for reduced maintenance cost.
- **XT-3 hose with O-ring face seals ...** provides a dry, reliable machine.
- **Cat 3054 engine ...** proven reliability, durable gear-driven water pump, thermal starting aid, parts commonality, and low cost per hour. Large fuel tank for extended operation.
- **Sloping, flip-open hood ...** allows excellent visibility to the loader working area and tilts up for single location access to all daily service points.
- **Stackable counterweights ...** allow easy adjustment of machine weight distribution. Lockable tool and battery boxes.
- **Cat radial-seal air filter ...** is an air cleaner and precleaner in a single unit, eliminates hood-mounted precleaner.
- **Operator compartment features:** Adjustable tilt steering is optional. Heating/air conditioning system with vents in the front console. Rear, door and side windows can be fully opened for enhanced visibility and cab roof is extended to help keep operator dry. Four-post Rollover Protective Structure (ROPS) for increased protection. Lunch box storage, rear mounted hand throttle, transmission disconnect switch on loader lift lever and low effort levers all add up to more precise control with a less fatigued operator.
- **Stabilizer legs ...** on the 428C and 438C use internal, self-lubricated, adjustable wear pads.



MODEL	416C		426C		436C	
Flywheel Power (Gross)	59 kW	78 hp	63 kW	84 hp	66 kW	89 hp
Flywheel Power (Net)	56 kW	75 hp*	60 kW	80 hp	63 kW	85 hp
Operating Weight	6300 kg	13,890 lb	7010 kg	15,450 lb	7075 kg	15,600 lb
Engine Model	3054 DINA		3054 DIT		3054 DIT	
Rated Engine RPM	2200		2200		2200	
No. of Cylinders	4		4		4	
Bore	100 mm	3.94 in	100 mm	3.94 in	100 mm	3.94 in
Stroke	127 mm	5 in	127 mm	5 in	127 mm	5 in
Displacement	4 L	243 in³	4 L	243 in³	4 L	243 in³
Speeds Forward	km/h	mph	km/h	mph	km/h	mph
1st	5.8	3.6	5.8	3.6	6.0	3.7
2nd	9.3	5.8	4.3	5.8	9.6	6.0
3rd	17.9	11.1	17.9	11.1	19.9	12.4
4th	34.0	21.1	34.0	21.1	33.7	20.9
Speeds Reverse						
1st	5.8	3.6	5.8	3.6	6.0	3.7
2nd	9.3	5.8	9.3	5.8	9.6	6.0
3rd	17.9	11.1	17.9	11.1	19.9	12.3
4th	34.0	21.1	34.0	21.1	33.7	20.9
Turning Circle Wall to Wall	10 670 mm	35'0"	10 800 mm	35'5"	10 859 mm	35'7"
All Wheel Steer Wall to Wall						
Two Wheel Steer	—		10 800 mm	35'5"	10 800 mm	35'5"
Circle Steer	—		10 400 mm	34'1"	10 400 mm	34'1"
Independent Rear	—		9500 mm	31'2"	9500 mm	31'2"
Tires, Single-Tilt, Front						
Standard, 2WD	11LX16, 10 PR, F3		11LX16, 10 PR, F3		11L-16, 12 PR, F3	
Standard, AWD	12.5/80-18, 10 PR, SG		12.5/80-18, 10 PR, SG		12.5/80-18, 10 PR, SG	
Tires, Single-Tilt, Rear						
Standard, 2WD	16.9X24, 8 PR, R4		16.9X24, 8 PR, R4		19.5L-24, 10 PR, IT525	
Standard, AWD	19.5LX24, 8 PR, IT525		19.5L-24, 8 PR, IT525		19.5L-24, 10 PR, IT525	
Standard, AWS	—		19.5L-24, 10 PR, IT525		19.5L-24, 10 PR, IT525	
Tire, Parallel Lift, Front						
Standard, 2WD	11LX16, 12 PR, F3		11LX16, 12 PR, F3		11L-16, 12 PR, F3	
Standard, AWD	12.5/80-18, 10 PR, SG		12.5/80-18, 10 PR, SG		12.5/80-18, 10 PR, SGI	
Tires, Parallel Lift, Rear						
Standard, 2WD	16.9X24, 8 PR, R4		16.9X24, 8 PR, R4		—	
Standard, AWD	19.5L-24, 8 PR, IT525		19.5L-24, 8 PR, IT525		19.5L-24, 10 PR, IT525	
Standard, AWS	—		19.5L-24, 10 PR, IT525		19.5L-24, 10 PR, IT525	
Hydraulic System, closed center	LSPC		LSPC		LSPC	
Pump capacity:	162 L/min @ 2200 rpm @ 20 700 kPa (43 gpm @		162 L/min @ 2200 rpm @ 20 700 kPa (43 gpm @		162 L/min @ 2200 rpm @ 20 700 kPa (43 gpm @	
	2200 rpm @ 3000 psi)		2200 rpm @ 3000 psi)		2200 rpm @ 3000 psi)	
Fuel Tank Capacity	128 L	34 U.S. gal	128 L	34 U.S. gal	128 L	34 U.S. gal

*With turbocharger 60 kW (80 hp).

Specifications

Backhoe Loaders



MODEL

446B

428C

438C

Flywheel Power (Gross)	82 kW	110 hp	59 kW	78 hp	66 kW	89 hp
Flywheel Power (Net)	76 kW	102 hp	56 kW	75 hp*	63 kW	85 hp
Operating Weight	8890 kg	19,600 lb	7416 kg	16,350 lb	7560 kg	16,670 lb
Engine Model	3114 DIT		3054 DINA		3054 DIT	
Rated Engine RPM	2200		2200		2200	
No. of Cylinders	4		4		4	
Bore	105 mm	4.13 in	100 mm	3.94 in	100 mm	3.94 in
Stroke	127 mm	5 in	127 mm	5 in	127 mm	5 in
Displacement	4.40 L	268 in³	4 L	243 in³	4 L	243 in³
Speeds Forward	km/h	mph	km/h	mph	km/h	mph
1st	6.6	4.1	5.7	3.5	5.8	3.6
2nd	12.1	7.5	9.1	5.6	9.3	5.8
3rd	21.7	13.5	18.7	11.6	19.2	11.9
4th	33.0	20.5	31.5	19.6	32.3	20.0
Speeds Reverse						
1st	7.3	4.5	5.7	3.5	5.8	3.6
2nd	13.4	8.3	9.1	5.6	9.3	5.8
3rd	24.1	15.0	18.7	11.6	19.2	11.9
4th	36.5	22.7	31.5	19.6	32.3	20.0
Turning Circle Wall to Wall	11 357 mm	37'3"	10 800 mm	35'5"	10 800 mm	35'5"
All Wheel Steer Wall to Wall						
Two Wheel Steer	—		—		10 800 mm	35'5"
Circle Steer	—		—		10 400 mm	34'1"
Independent Rear	—		—		9500 mm	31'2"
Tires, Single-Tilt, Front						
Standard, 2WD	14.5/75-16, 10 PR, F3		11L-16, 10 PR, F3		—	
Standard, AWD	12.5-20, 10 PR, R4		10.5-20, 10 PR, ISG		12.5/80-18, 10 PR, SG	
Tires, Single-Tilt, Rear						
Standard, 2WD	21L-24, 12 PR, R4, IT525		16.9-28, 10 PR, R4, ISG		—	
Standard, AWD	21L-24, 12 PR, R4, IT525		16.9-28, 10 PR, R4, ISG		16.9-28, 10 PR, R4, ISG	
Standard, AWS	—		—		16.9-28, 10 PR, R4, ISG	
Tire, Parallel Lift, Front						
Standard, 2WD	—		11L-16, 12 PR, F3		—	
Standard, AWD	—		12.5/80-18, 10 PR, SG		12.5/80-18, 10 PR, SG	
Standard, AWD	—		12.5/80-18, 10 PR, SGI		12.5/80-18, 10 PR, SGI	
Tires, Parallel Lift, Rear						
Standard, 2WD	—		16.9-28, 10 PR, R4, ISG		—	
Standard, AWD	—		—		16.9-28, 10 PR, R4, ISG	
Standard, AWD	—		—		**16.9-28, 12 PR, R4, ISG	
Standard, AWS	—		—		16.9-28, 10 PR, R4, ISG	
Hydraulic System, closed center	LSPC		LSPC		LSPC	
Pump capacity:	178 L/min @		155 L/min @		162 L/min @	
	2200 rpm @ 22 400 kPa		2200 rpm @ 20 700 kPa		2200 rpm @ 20 700 kPa	
	(47 gpm @		(41 gpm @		(43 gpm @	
	2200 rpm @ 3250 psi)		2200 rpm @ 3000 psi)		2200 rpm @ 3000 psi)	
Fuel Tank Capacity	125 L	33 U.S. gal	128 L	34 U.S. gal	128 L	34 U.S. gal

*With turbocharger 60 kW (80 hp).

**For use with E-Stick.

MODEL	416C	426C	436C
Tires, Single-Tilt, Front			
Standard, 2WD	11L-16, 10 PR, F3	11L-16, 10 PR, F3	—
Standard, 2WD	—	—	11L-16, 12 PR, F3
Optional, 2WD	11L-16, 12 PR, F3	11L-16, 12 PR, F3	—
Optional, 2WD	—	14.5/75-16, 10 PR, F3	14.5/75-16, 10 PR, F3
Standard, 4WD	—	—	—
Standard, AWD	12.5/80-18, 10 PR, SG	12.5/80-18, 10 PR, SG	12.5/80-18, 10 PR, SG
Standard, AWD	—	—	—
Optional, AWD	—	—	—
Optional, AWD	—	—	—
Optional, AWD	—	—	—
Optional, AWD	340/80-R18, IT510	340/80-R18, IT510	340/80-R18, IT510
Tires, Single-Tilt, Rear			
Standard, 2WD	*16.9-24, 8 PR, R4	*16.9-24, 8 PR, R4	19.5L-24, 10 PR, IT525
Optional, 2WD	**16.9-24, 10 PR, R4	**16.9-24, 10 PR, R4	19.5LR-24, IT510
Optional, 2WD	19.5L-24, 8 PR, IT525	19.5L-24, 8 PR, IT525	21L-24, 12 PR, IT525
Optional, 2WD	19.5L-24, 10 PR, IT525	19.5L-24, 10 PR, IT525	—
Optional, 2WD	19.5LR-24, IT510	19.5LR-24, IT510	—
Optional, 2WD	—	21L-24, 12 PR, IT525	—
Optional, 2WD	—	—	—
Standard, 4WD	19.5L-24, 8 PR, IT525	19.5L-24, 8 PR, IT525	—
Standard, AWD	—	—	19.5L-24, 10 PR, IT525
Optional, AWD	19.5L-24, 10 PR, IT525	19.5L-24, 10 PR, IT525	—
Optional, AWD	19.5LR-24, IT510	19.5LR-24, IT510	19.5LR-24, IT510
Optional, AWD	—	21L-24, 12 PR, IT525	21L-24, 12 PR, IT525
Optional, AWD	—	—	—
Optional, AWD	—	—	—
Optional, AWD	—	—	—
Standard, AWS	—	19.5L-24, 10 PR, IT525	19.5L-24, 10 PR, IT525
Optional, AWS	—	19.5LR-24, IT510	19.5LR-24, IT510
Optional, AWS	—	—	—
Optional, AWS	—	—	—
Tires, Parallel Lift, Front			
Standard, 2WD	11L-16, 12 PR, F3	11L-16, 12 PR, F3	11L-16, 12 PR, F3
Optional, 2WD	—	14.5/75-16, 10 PR, F3	14.5/75-16, 10 PR, F3
Standard, AWD	12.5/80-18, 10 PR, SG	12.5/80-18, 10 PR, SG	12.5/80-18, 10 PR, SG
Standard, AWD	—	—	—
Optional, AWD	—	—	—
Optional, AWD	340/80-R18, IT510	340/80-R18, IT510	340/80-R18, IT510
Tires, Parallel Lift, Rear			
Standard, 2WD	*16.9-24, 8 PR, R4	*16.9-24, 8 PR, R4	—
Optional, 2WD	**16.9-24, 10 PR, R4	**16.9-24, 10 PR, R4	—
Optional, 2WD	19.5L-24, 8 PR, IT525	19.5L-24, 8 PR, IT525	—
Optional, 2WD	19.5L-24, 10 PR, IT525	19.5L-24, 10 PR, IT525	19.5L-24, 10 PR, IT525
Optional, 2WD	19.5LR-24, IT510	19.5LR-24, IT510	19.5LR-24, IT510
Optional, 2WD	—	21L-24, 12 PR, IT525	21L-24, 12 PR, IT525
Optional, 2WD	—	—	—
Standard, AWD	19.5L-24, 8 PR, IT525	19.5L-24, 8 PR, IT525	19.5L-24, 10 PR, IT525
Standard, AWD	—	—	—
Optional, AWD	19.5L-24, 10 PR, IT525	19.5L-24, 10 PR, IT525	19.5LR-24, IT510
Optional, AWD	19.5LR-24, IT510	19.5LR-24, IT510	21L-24, 12 PR, IT525
Optional, AWD	—	21L-24, 12 PR, IT525	—
Optional, AWD	—	—	—
Standard, AWS	—	19.5L-24, 10 PR, IT525	19.5L-24, 10 PR, IT525
Optional, AWS	—	19.5LR-24, IT510	19.5LR-24, IT510
Optional, AWS	—	—	—
Optional, AWS	—	—	—

*Not for use with E-Stick.
 **For use with E-Stick.

MODEL	446B	428C	438C
Tires, Single-Tilt, Front			
Standard, 2WD	14.5/75-16, 10 PR, F3	11L-16, 10 PR, F3	—
Standard, 2WD	—	—	—
Optional, 2WD	—	11L-16, 12 PR, F3	—
Optional, 2WD	—	14.5/75-16, 10 PR, F3	—
Standard, 4WD	12.5-20, 10 PR, R4, IT525	10.5-20, 10 PR, ISG	—
Standard, AWD	—	—	12.5/80-18, 10 PR, SG
Standard, AWD	—	—	12.5/80-18, 10 PR, SGI
Optional, AWD	—	12.5/80-18, 10 PR, SG	—
Optional, AWD	—	12.5/80-18, 10 PR, SGI	—
Optional, AWD	—	335/80R-18, MX27	335/80R-18, MX27
Optional, AWD	—	340/80R-18, IT510	340/80R-18, IT510
Tires, Single-Tilt, Rear			
Standard, 2WD	21L-24, 12 PR, R4, IT525	*16.9-28, 10 PR, R4, ISG	—
Optional, 2WD	—	**16.9-28, 12 PR, R4, ISG	—
Optional, 2WD	—	16.9/14-28, 12 PR, R1	—
Optional, 2WD	—	16.9R-28, MX27	—
Optional, 2WD	—	16.9R-28, IT510	—
Optional, 2WD	—	18.4/15-26, 12 PR, ISG	—
Optional, 2WD	—	18.4/15R-26, MX27	—
Standard, 4WD	—	*16.9-28, 10 PR, R4, ISG	*16.9-28, 10 PR, R4, ISG
Standard, AWD	—	—	—
Optional, AWD	—	**16.9-28, 12 PR, R4, ISG	**16.9-28, 12 PR, R4, ISG
Optional, AWD	21L-24, 12 PR, R4, IT525	16.9/14-28, 12 PR, R1	—
Optional, AWD	—	16.9R-28, MX27	16.9R-28, MX27
Optional, AWD	—	16.9R-28, IT510	16.9R-28, IT510
Optional, AWD	—	18.4/15-26, 12 PR, ISG	18.4/15-26, 12 PR, ISG
Optional, AWD	—	18.4/15R-26, MX27	18.4/15R-26, MX27
Standard, AWS	—	—	*16.9-28, 10 PR, R4, ISG
Optional, AWS	—	—	*16.9-28, 12 PR, R4, ISG
Optional, AWS	—	—	16.9R-28, MX27
Optional, AWS	—	—	16.9R-28, IT510
Tires, Parallel Lift, Front			
Standard, 2WD	—	11L-16, 12 PR, F3	—
Optional, 2WD	—	14.5/75-16, 10 PR, F3	—
Standard, AWD	—	12.5/80-18, 10 PR, SG	12.5/80-18, 10 PR, SG
Standard, AWD	—	12.5/80-18, 10 PR, SGI	12.5/80-18, 10 PR, SGI
Optional, AWD	—	335/80R-18, MX27	335/80R-18, MX27
Optional, AWD	—	340/80R-18, IT510	340/80R-18, IT510
Tires, Parallel Lift, Rear			
Standard, 2WD	—	*16.9-28, 10 PR, R4, ISG	—
Optional, 2WD	—	*16.9-28, 12 PR, R4, ISG	—
Optional, 2WD	—	16.9/14-28, 12 PR, R1	—
Optional, 2WD	—	16.9R-28, MX27	—
Optional, 2WD	—	16.9R-28, IT510	—
Optional, 2WD	—	18.4/15-26, 12 PR, ISG	—
Optional, 2WD	—	18.4/15R-26, MX27	—
Standard, AWD	—	—	*16.9-28, 10 PR, R4, ISG
Standard, AWD	—	—	**16.9-28, 12 PR, R4, ISG
Optional, AWD	—	—	16.9R-28, MX27
Optional, AWD	—	—	16.9R-28, IT510
Optional, AWD	—	—	18.4/15-26, 12 PR, ISG
Optional, AWD	—	—	18.4/15R-26, MX27
Standard, AWS	—	—	*16.9-28, 10 PR, R4, ISG
Optional, AWS	—	—	**16.9-28, 12 PR, R4, ISG
Optional, AWS	—	—	16.9R-28, MX27
Optional, AWS	—	—	16.9R-28, IT510

*Not for use with E-Stick.

**For use with E-Stick.

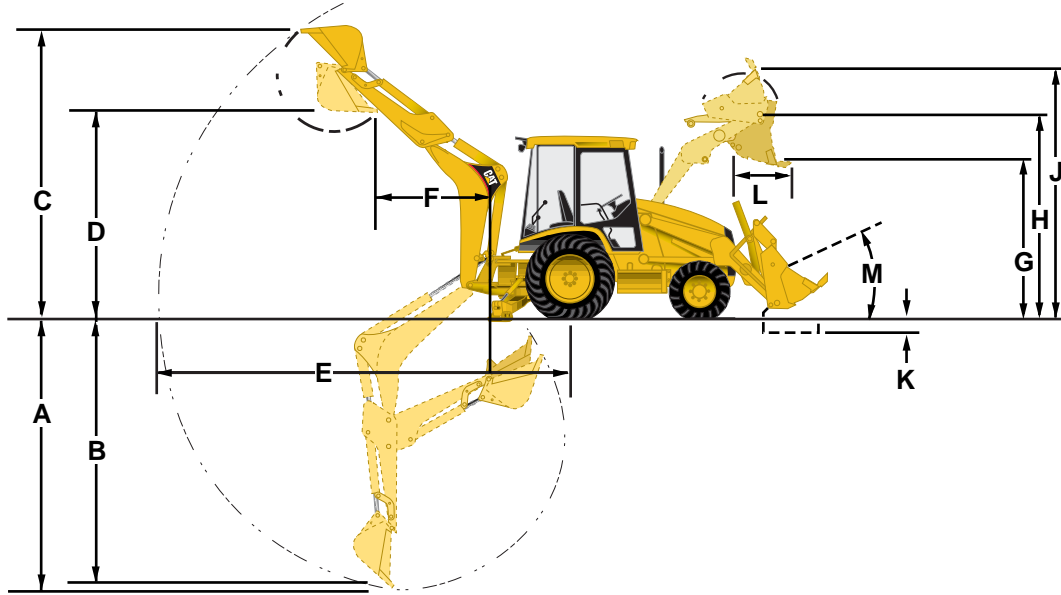

MODEL	416C*					
Backhoe	Standard Stick		Extendible Stick Retracted		Extendible Stick Extended	
A) Digging depth (SAE max.)	4420 mm	14'6"	4498 mm	14'9"	5545 mm	18'2"
B) 610 mm (2'0") flat bottom (SAE)	4379 mm	14'4"	4446 mm	14'7"	5498 mm	18'1"
C) Overall operating height — fully raised	5269 mm	17'3"	5240 mm	17'2"	5919 mm	19'5"
D) Loading height	3483 mm	11'5"	3654 mm	12'0"	4223 mm	13'10"
E) Overall reach from rear axle centerline	6729 mm	22'1"	6772 mm	22'3"	7770 mm	25'6"
Overall reach from swing pivot @ ground line	5639 mm	18'6"	5682 mm	18'8"	6680 mm	21'11"
F) Loading reach	1764 mm	5'10"	1804 mm	5'11"	2706 mm	8'11"
Swing arc	180°		180°		180°	
Bucket rotation — Vertical wall position	170°		165°		165°	
Truck loading position	170°		165°		165°	
Stabilizer spread —						
Operating position	3219 mm	10'7"	3219 mm	10'7"	3219 mm	10'7"
Transport position	2352 mm	7'9"	2352 mm	7'9"	2352 mm	7'9"
Digging force, bucket cylinder, SAE	52 kN	11,700 lb	53.7 kN	12,065 lb	53.7 kN	12,065 lb
Digging force, stick cylinder, SAE	34.3 kN	7704 lb	34.9 kN	7836 lb	25.1 kN	5635 lb
Leveling angle (maximum slope on which backhoe will make vertical cut)	14°		14°		14°	

*Equipped with 610 mm (2'0") standard duty bucket.

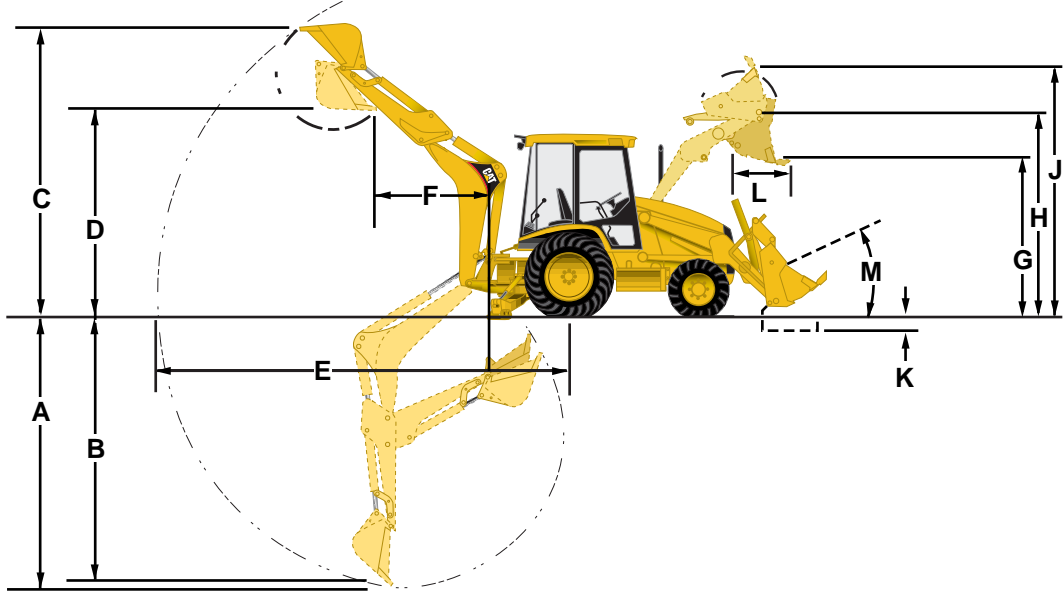

MODEL	426C*					
	Standard Stick		Extendible Stick Retracted		Extendible Stick Extended	
Backhoe						
A) Digging depth (SAE max.)	4721 mm	15'6"	4956 mm	16'3"	6169 mm	20'3"
B) 610 mm (2'0") flat bottom (SAE)	4696 mm	15'4"	4909 mm	16'1"	6129 mm	20'1"
C) Overall operating height — fully raised	5752 mm	18'11"	5832 mm	19'2"	6667 mm	21'11"
D) Loading height	3815 mm	12'6"	4096 mm	13'5"	4925 mm	16'2"
E) Overall reach from rear axle centerline	7146 mm	23'5"	7332 mm	24'1"	8485 mm	27'10"
Overall reach from swing pivot	6056 mm	19'10"	6242 mm	20'6"	7395 mm	24'3"
F) Loading reach	1711 mm	5'7"	1823 mm	6'0"	2717 mm	8'11"
Swing arc		180°		180°		180°
Bucket rotation — Vertical wall position		170°		165°		165°
Truck loading position		170°		165°		165°
Stabilizer spread —						
Operating position	3219 mm	10'7"	3219 mm	10'7"	3219 mm	10'7"
Transport position	2352 mm	7'9"	2352 mm	7'9"	2352 mm	7'9"
Digging Force; Bucket cylinder, SAE	64.3 kN	14,440 lb	64.3 kN	14,440 lb	64.3 kN	14,440 lb
Digging Force; Stick cylinder, SAE	37.9 kN	8510 lb	39.1 kN	8790 lb	28.1 kN	6310 lb
Leveling angle (maximum slope on which backhoe will make vertical cut)		14°		14°		14°

*Equipped with 610 mm (2'0") heavy duty bucket.

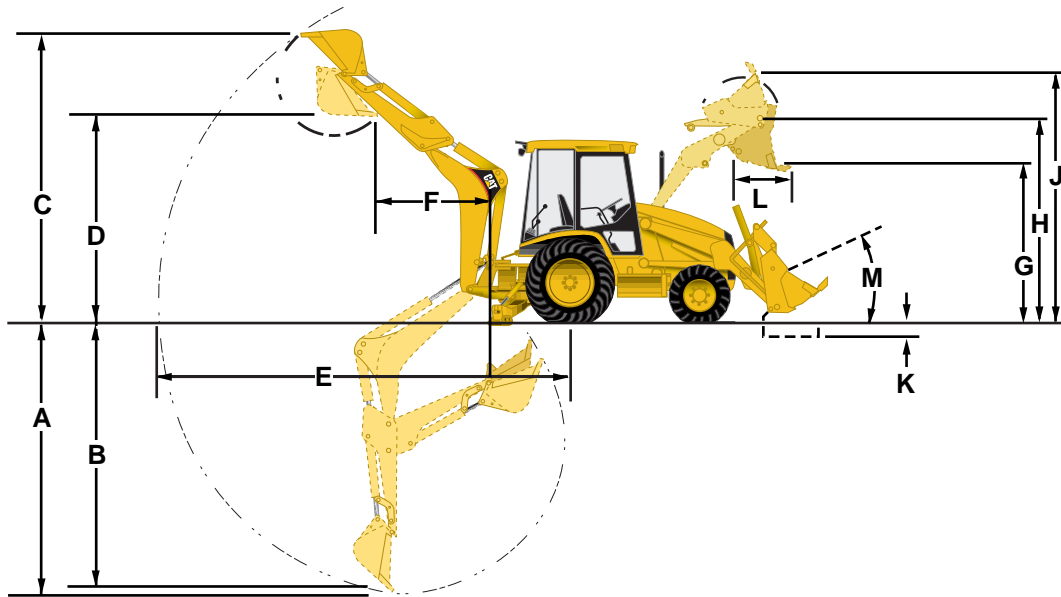

MODEL	436C*					
Backhoe	Standard Stick		Extendible Stick Retracted		Extendible Stick Extended	
A) Digging depth (SAE max.)	4953 mm	16'3"	4995 mm	16'5"	6202 mm	20'4"
B) 610 mm (2'0") flat bottom (SAE)	4926 mm	16'2"	4938 mm	16'2"	6160 mm	20'3"
C) Overall operating height — fully raised	5862 mm	19'3"	5664 mm	18'7"	6444 mm	21'2"
D) Loading height	3935 mm	12'11"	4003 mm	13'2"	4783 mm	15'8"
E) Overall reach from rear axle centerline	7358 mm	24'2"	7344 mm	24'1"	8496 mm	27'11"
Overall reach from swing pivot	6268 mm	20'7"	6254 mm	20'6"	7406 mm	24'4"
F) Loading reach	1917 mm	6'4"	2038 mm	6'8"	2717 mm	8'11"
Swing arc	180°		180°		180°	
Bucket rotation — Vertical wall position	170°		165°		165°	
Truck loading position	170°		165°		165°	
Stabilizer spread —						
Operating position	3219 mm	10'7"	3219 mm	10'7"	3219 mm	10'7"
Transport position	2352 mm	7'9"	2352 mm	7'9"	2352 mm	7'9"
Digging Force; Bucket cylinder, SAE	64.2 kN	14,440 lb	64.2 kN	14,440 lb	64.2 kN	14,440 lb
Digging Force; Stick cylinder, SAE	38.7 kN	8685 lb	40.3 kN	9060 lb	29 kN	6529 lb
Leveling angle (maximum slope on which backhoe will make vertical cut)	14°		14°		14°	

*Equipped with 610 mm (2'0") heavy duty bucket.

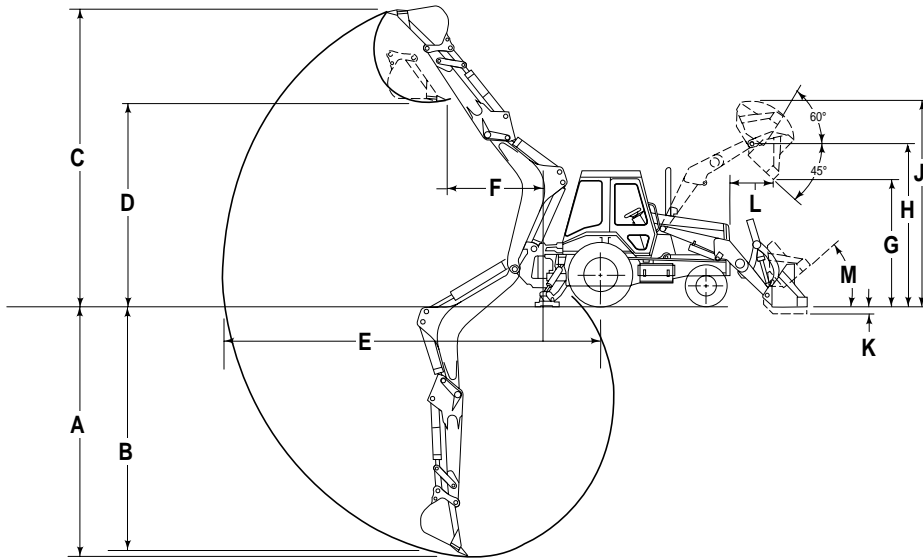

MODEL	446B*					
Backhoe	Standard Stick		Extendible Stick Retracted		Extendible Stick Extended	
A) Digging depth (SAE max.)	5219 mm	17'2"	5182 mm	17'0"	6528 mm	21'5"
B) 610 mm (2'0") flat bottom (SAE)	5173 mm	17'0"	5134 mm	16'10"	6479 mm	21'3"
C) Overall operating height — fully raised	6335 mm	20'9"	6298 mm	20'8"	7240 mm	23'9"
D) Loading height	4310 mm	14'2"	4205 mm	13'10"	4894 mm	16'1"
E) Overall reach from rear axle centerline	7866 mm	25'10"	7825 mm	25'8"	9130 mm	29'11"
Overall reach from swing pivot	6604 mm	21'8"	6563 mm	21'6"	7868 mm	25'9"
F) Loading reach	2027 mm	6'8"	2070 mm	6'9"	3261 mm	10'8"
Swing arc	180°		180°		180°	
Bucket rotation — Vertical wall position	169°		163°		163°	
Truck loading position	169°		163°		163°	
Stabilizer spread —						
Operating position	4084 mm	13'5"	4084 mm	13'5"	4084 mm	13'5"
Transport position	2405 mm	7'11"	2405 mm	7'11"	2405 mm	7'11"
Digging force, bucket cylinder, SAE	67.6 kN	15,200 lb	67.4 kN	15,150 lb	67.4 kN	15,150 lb
Digging force, stick cylinder, SAE	48 kN	10,800 lb	49.8 kN	11,200 lb	34.8 kN	7830 lb
Leveling angle (maximum slope on which backhoe will make vertical cut)	13°		13°		13°	

*Equipped with 610 mm (2'0") standard duty bucket.

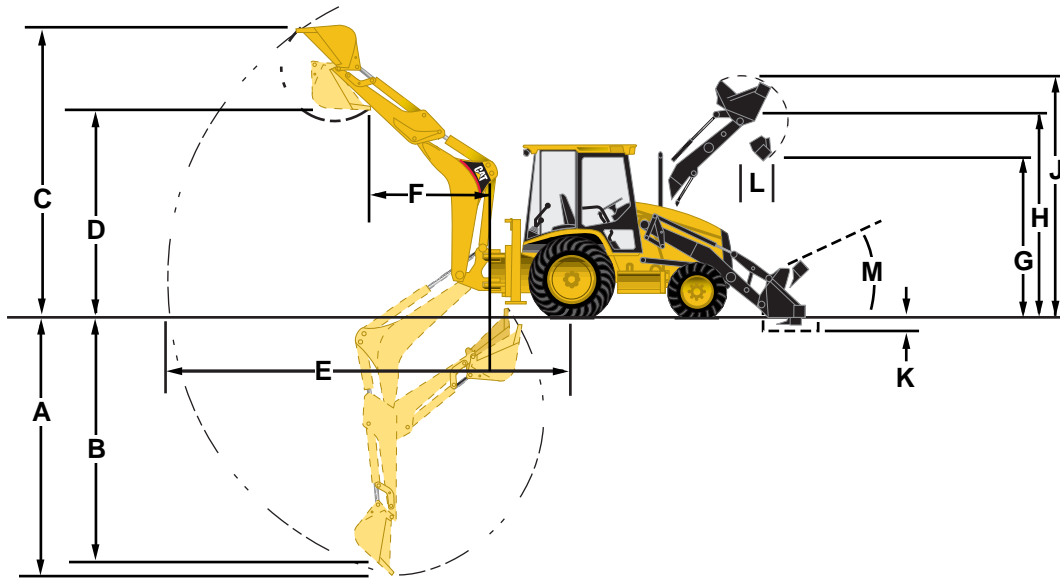

MODEL	428C*					
Backhoe	Standard Stick		Extendible Stick Retracted		Extendible Stick Extended	
A) Digging depth (SAE max.)	4153 mm	13'7"	4236 mm	13'11"	5290 mm	17'4"
B) 610 mm (2'0") flat bottom (SAE)	4120 mm	13'6"	4190 mm	13'9"	5246 mm	17'2"
C) Overall operating height — fully raised	5564 mm	18'3"	5541 mm	18'2"	6250 mm	20'6"
D) Loading height	3803 mm	12'5"	3845 mm	12'7"	4454 mm	14'7"
E) Overall reach from rear axle centerline	6903 mm	22'8"	6947 mm	22'10"	7950 mm	26'1"
Overall reach from swing pivot @ ground line	5727 mm	18'9"	5622 mm	18'5"	6625 mm	21'9"
F) Loading reach	1638 mm	5'4"	1677 mm	5'6"	2579 mm	8'6"
Swing arc	180°		180°		180°	
Sideshift from machine centerline	630 mm	2'1"	630 mm	2'1"	630 mm	2'1"
Bucket rotation — Vertical wall position	170°		170°		170°	
Truck loading position	170°		170°		170°	
Stabilizer spread	2360 mm	7'9"	2360 mm	7'9"	2360 mm	7'9"
Digging Force; Bucket cylinder	52 kN	11,693 lb	53.6 kN	12,057 lb	53.6 kN	12,056 lb
Digging Force; Stick cylinder	34 kN	7631 lb	33.6 kN	7541 lb	23.8 kN	5356 lb
Leveling angle (maximum slope on which backhoe will make vertical cut)	11°		11°		11°	

*Equipped with 610 mm (2'0") heavy duty bucket.

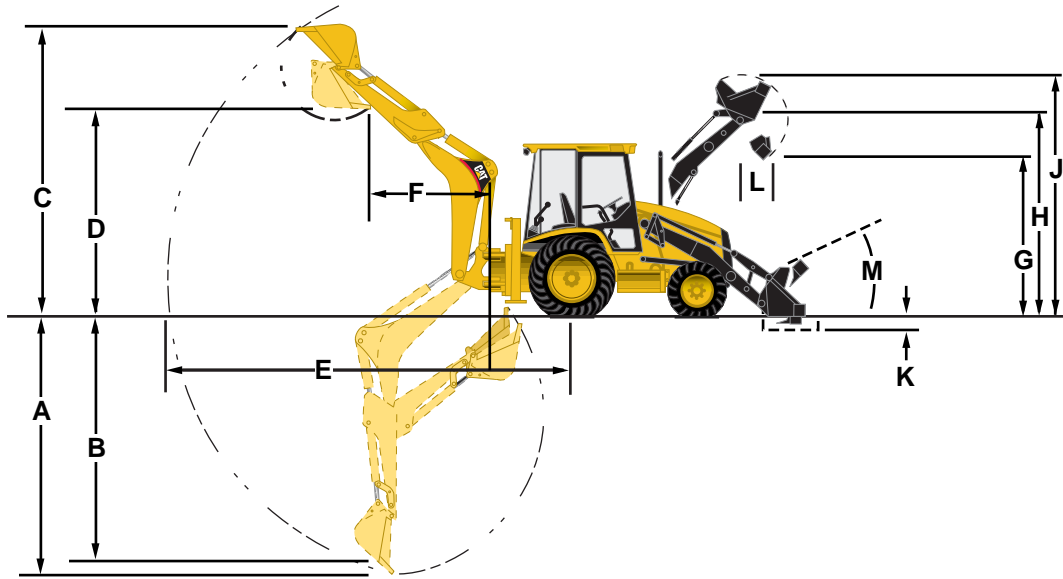

MODEL	438C*					
Backhoe	Standard Stick		Extendible Stick Retracted		Extendible Stick Extended	
A) Digging depth (SAE max.)	4326 mm	14'2"	4405 mm	14'5"	5455 mm	17'11"
B) 610 mm (2'0") flat bottom (SAE)	4288 mm	14'1"	4356 mm	14'3"	5409 mm	17'9"
C) Overall operating height — fully raised	5568 mm	18'3"	5532 mm	18'2"	6220 mm	20'5"
D) Loading height	3684 mm	12'1"	3766 mm	12'4"	4344 mm	14'3"
E) Overall reach from rear axle centerline	7036 mm	23'1"	7072 mm	23'3"	8081 mm	26'7"
Overall reach from swing pivot @ ground line	5711 mm	18'9"	5752 mm	18'10"	6756 mm	22'2"
F) Loading reach	1660 mm	5'5"	1699 mm	5'7"	2596 mm	8'6"
Swing arc	180°		180°		180°	
Sideshift from machine centerline	630 mm	2'1"	630 mm	2'1"	630 mm	2'1"
Bucket rotation — Vertical wall position	170°		165°		165°	
Truck loading position	170°		165°		165°	
Stabilizer spread	2360 mm	7'9"	2360 mm	7'9"	2360 mm	7'9"
Digging Force; Bucket cylinder	54.2 kN	12,195 lb	53.6 kN	12,060 lb	53.6 kN	12,060 lb
Digging Force; Stick cylinder	33 kN	7427 lb	33.5 kN	7531 lb	23.8 kN	5350 lb
Leveling angle (maximum slope on which backhoe will make vertical cut)	11°		11°		11°	

*Equipped with 610 mm (2'0") heavy duty backhoe bucket.

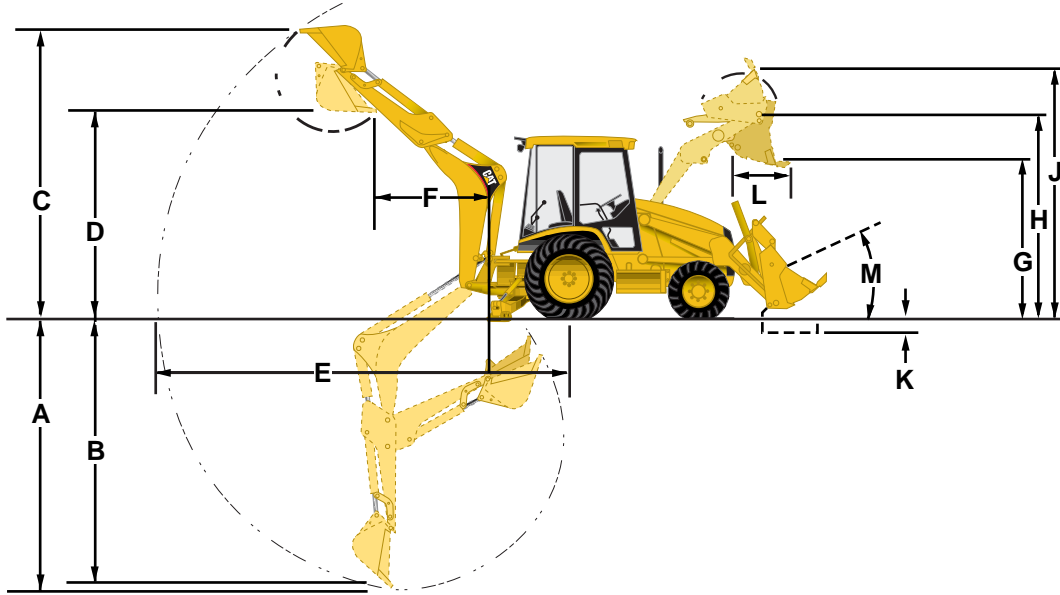

MODEL	416C									
Loader	Single Tilt					IT Loader with QC				
Bucket	General Purpose		General Purpose		Multi-Purpose		General Purpose		Multi-Purpose	
Bucket capacity	0.76 m ³	1 yd ³	0.96 m ³	1.25 yd ³	0.96 m ³	1.25 yd ³	0.96 m ³	1.25 yd ³	0.96 m ³	1.25 yd ³
Width	2262 mm	7'5"	2262 mm	7'5"	2262 mm	7'5"	2262 mm	7'5"	2262 mm	7'5"
Lift capacity at max height	2622 kg	5780 lb	2486 kg	5480 lb	2368 kg	5220 lb	3250 kg	7166 lb	2981 kg	6570 lb
Breakout force	40 kN	9030 lb	38.3 kN	8606 lb	42 kN	9490 lb	47.1 kN	10,600 lb	46.6 kN	10,485 lb
G) Dump height @ max dump angle	2650 mm	8'8"	2575 mm	8'5"	2640 mm	8'8"	2495 mm	8'2"	2560 mm	8'5"
H) Hinge pin height	3290 mm	10'10"	3290 mm	10'10"	3290 mm	10'10"	3290 mm	10'10"	3290 mm	10'10"
J) Max operating height	4020 mm	13'2"	4170 mm	13'8"	4200 mm	13'9"	4170 mm	13'8"	4200 mm	13'9"
K) Digging depth	105 mm	4"	105 mm	4"	105 mm	4"	105 mm	4"	135 mm	5"
Grading angle	110°		106°		110°		107°		111°	
Width of dozer cutting edge	—	—	—	—	2406 mm	7'11"	—	—	2262 mm	7'11"
Clam opening — maximum	—	—	—	—	790 mm	2'7"	—	—	790 mm	2'7"
L) Reach @ full height max dump angle	730 mm	2'5"	810 mm	2'8"	700 mm	2'4"	840 mm	2'9"	730 mm	2'5"
M) Maximum rollback @ groundline	40°		40°		40°		40°		41°	
Weight	380 kg	838 lb	428 kg	944 lb	659 kg	1453 lb	466 kg	983 lb	659 kg	1453 lb

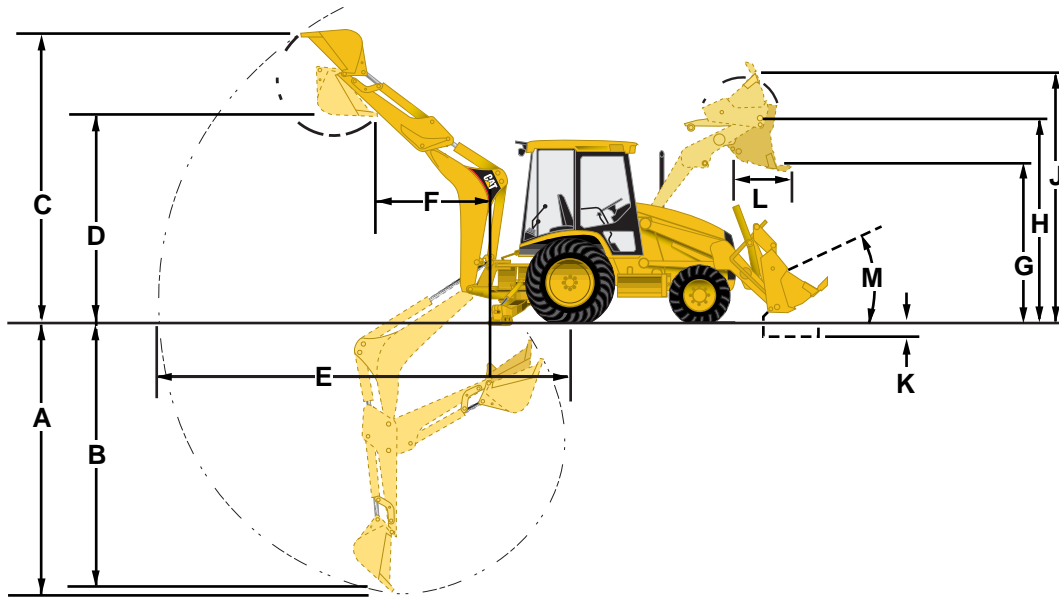

MODEL	426C									
Loader	Single Tilt									
Bucket	General Purpose		General Purpose*		General Purpose		Multi-Purpose		Multi-Purpose*	
Bucket capacity	0.96 m ³	1.25 yd ³	1 m ³	1.31 yd ³	1.07 m ³	1.40 yd ³	0.96 m ³	1.25 yd ³	1.03 m ³	1.35 yd ³
Width	2262 mm	7'5"	2406 mm	7'11"	2262 mm	7'5"	2262 mm	7'5"	2406 mm	7'11"
Lift capacity at full height	2826 kg	6230 lb	2930 kg	6460 lb	2876 kg	6340 lb	2771 kg	6110 lb	2750 kg	6064 lb
Breakout force	45.3 kN	10,181 lb	45.4 kN	10,204 lb	44.5 kN	10,000 lb	44.7 kN	10,035 lb	44.4 kN	9979 lb
G) Dump height @ max dump angle	2575 mm	8'5"	2610 mm	8'7"	2555 mm	8'5"	2640 mm	8'8"	2640 mm	8'8"
H) Hinge pin height	3290 mm	10'10"	3290 mm	10'10"	3290 mm	10'10"	3290 mm	10'10"	3290 mm	10'10"
J) Max operating height	4170 mm	13'8"	4170 mm	13'8"	4215 mm	13'10"	4200 mm	13'9"	4200 mm	13'9"
K) Digging depth	105 mm	4"	105 mm	4"	145 mm	6"	135 mm	5"	135 mm	5"
Grading angle	106°		107°		107°		110°		110°	
Width of dozer cutting edge	—	—	—	—	—	—	2406 mm	7'11"	2406 mm	7'11"
Clam opening — maximum	—	—	—	—	—	—	790 mm	2'7"	790 mm	2'7"
L) Reach @ full height max dump angle	810 mm	2'8"	780 mm	2'7"	780 mm	2'7"	700 mm	2'3"	700 mm	2'4"
M) Maximum rollback @ groundline	40°		40°		41°		41°		40°	
Weight	428 kg	944 lb	440 kg	970 lb	437 kg	964 lb	659 kg	1453 lb	682 kg	1504 lb

*Recommended for use with All Wheel Steer option.

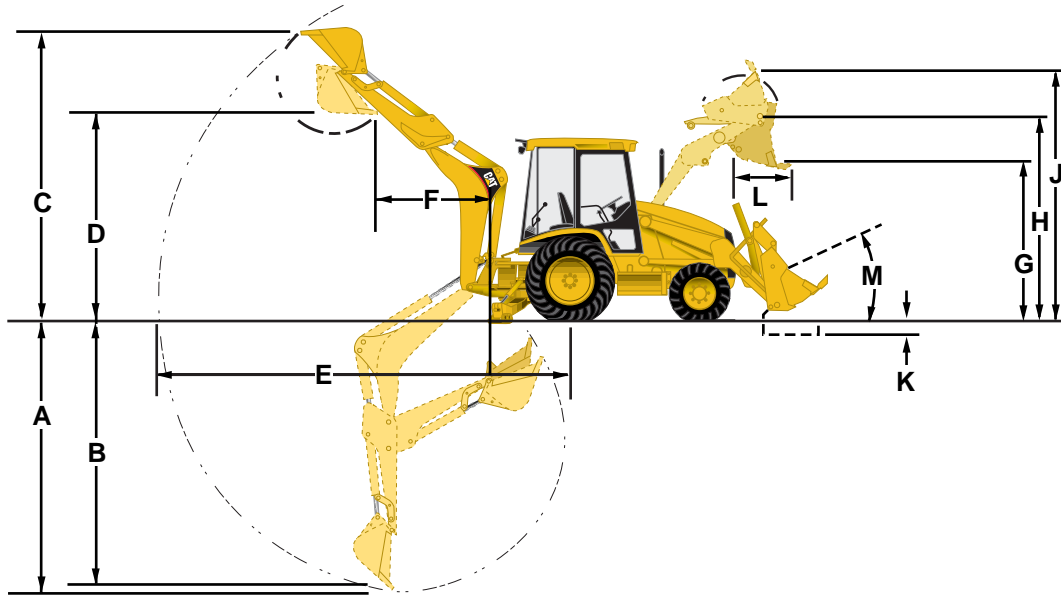

MODEL	426C							
Loader	IT Loader with QC							
Bucket	General Purpose		General Purpose*		Multi-Purpose		Multi-Purpose*	
Bucket capacity	0.96 m ³	1.25 yd³	1 m ³	1.31 yd³	0.96 m ³	1.25 yd³	1.03 m ³	1.35 yd³
Width	2262 mm	7'5"	2406 mm	7'11"	2262 mm	7'5"	2406 mm	7'11"
Lift capacity at full height	3116 kg	6871 lb	3190 kg	7034 lb	2981 kg	6573 lb	2955 kg	6516 lb
Breakout force	45.8 kN	10,300 lb	46.9 kN	10,541 lb	45.4 kN	10,200 lb	46.5 kN	10,451 lb
G) Dump height @ max dump angle	2495 mm	8'2"	2530 mm	8'4"	2560 mm	8'5"	2560 mm	8'5"
H) Hinge pin height	3290 mm	10'10"	3290 mm	10'10"	3290 mm	10'10"	3290 mm	10'10"
J) Max operating height	4170 mm	13'8"	4170 mm	13'8"	4200 mm	13'9"	4200 mm	13'9"
K) Digging depth	105 mm	4"	105 mm	4"	135 mm	5"	135 mm	5"
Grading angle	107°		108°		111°		111°	
Width of dozer cutting edge	—	—	—	—	2262 mm	7'5"	2262 mm	7'5"
Clam opening — maximum	—	—	—	—	790 mm	2'7"	790 mm	2'7"
L) Reach @ full height/max dump angle	840 mm	2'9"	810 mm	2'8"	730 mm	2'5"	730 mm	2'5"
M) Maximum rollback @ groundline	40°		40°		41°		41°	
Weight	446 kg	983 lb	459 kg	1012 lb	659 kg	1453 lb	682 kg	1504 lb

*Recommended for use with All Wheel Steer option.

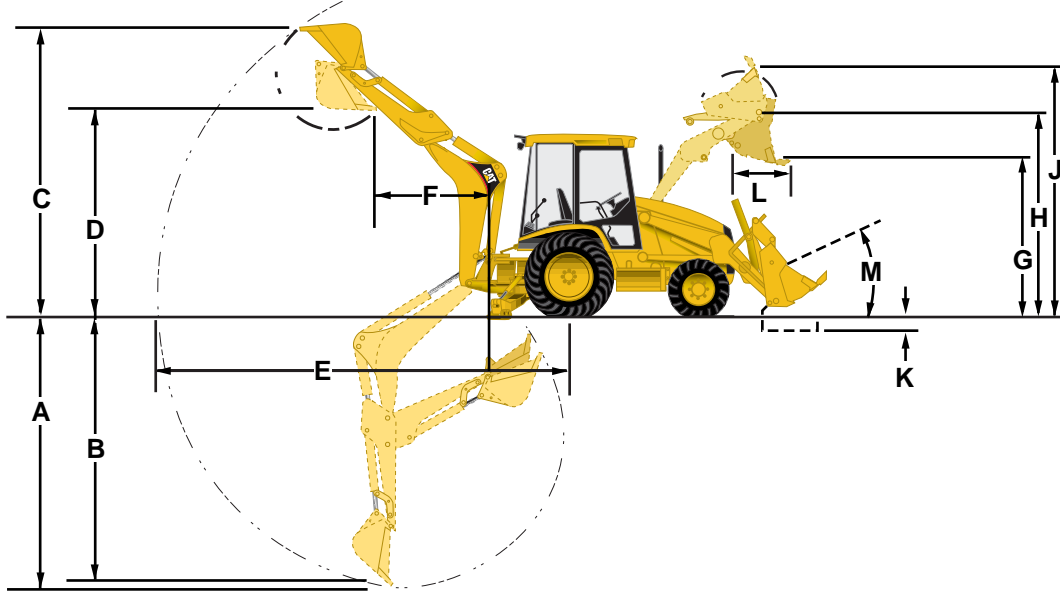

MODEL	436C									
Loader	Single Tilt									
Bucket	General Purpose*		General Purpose		General Purpose*		Multi-Purpose		Multi-Purpose*	
Bucket capacity	1 m ³	1.31 yd ³	1.07 m ³	1.40 yd ³	1.15 m ³	1.50 yd ³	0.96 m ³	1.25 yd ³	1.03 m ³	1.35 yd ³
Width	2406 mm	7'11"	2262 mm	7'5"	2406 mm	7'11"	2262 mm	7'5"	2406 mm	7'11"
Lift capacity at full height	3000 kg	6614 lb	2946 kg	6494 lb	2901 kg	6395 lb	2845 kg	6273 lb	2821 kg	6218 lb
Breakout force	45.7 kN	10,278 lb	44.9 kN	10,080 lb	44.4 kN	9990 lb	45 kN	10,125 lb	44.8 kN	10,069 lb
G) Dump height @ max dump angle	2670 mm	8'9"	2620 mm	8'7"	2590 mm	8'6"	2705 mm	8'11"	2305 mm	7'7"
H) Hinge pin height	3350 mm	11'0"	3350 mm	11'0"	3350 mm	11'0"	3350 mm	11'0"	3350 mm	11'0"
J) Max operating height	4230 mm	13'11"	4270 mm	14'0"	4270 mm	14'0"	4260 mm	14'0"	4260 mm	14'0"
K) Digging depth	43 mm	2"	85 mm	3"	85 mm	3"	75 mm	3"	75 mm	3"
Grading angle	108°		108°		108°		111°		111°	
Width of dozer cutting edge	—	—	—	—	—	—	2262 mm	7'5"	2406 mm	7'11"
Clam opening — maximum	—	—	—	—	—	—	790 mm	2'7"	790 mm	2'7"
L) Reach @ full height max dump angle	750 mm	2'6"	750 mm	2'6"	750 mm	2'6"	670 mm	2'2"	670 mm	2'2"
M) Maximum rollback @ groundline	39°		40°		40°		40°		40°	
Weight	440 kg	970 lb	437 kg	964 lb	456 kg	1003 lb	659 kg	1453 lb	682 kg	1504 lb

*Recommended for use with All Wheel Steer option.

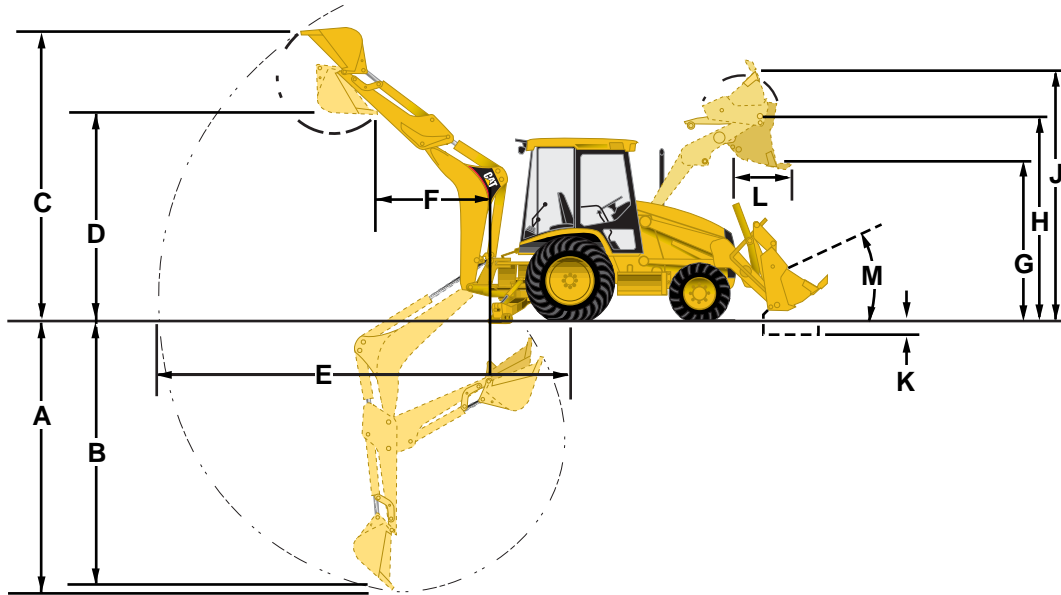

MODEL	436C							
Loader	IT Loader with QC							
Bucket	General Purpose*		General Purpose*		Multi-Purpose		Multi-Purpose*	
Bucket capacity	1 m ³	1.31 yd ³	1.15 m ³	1.50 yd ³	0.96 m ³	1.25 yd ³	1.03 m ³	1.35 yd ³
Width	2406 mm	7'11"	2406 mm	7'11"	2262 mm	7'5"	2262 mm	7'5"
Lift capacity at full height	3264 kg	7196 lb	3211 kg	7080 lb	3056 kg	6739 lb	3031 kg	6681 lb
Breakout force	46.8 kN	10,518 lb	45.9 kN	10,316 lb	46.6 kN	10,462 lb	46.4 kN	10,429 lb
G) Dump height @ max dump angle	2590 mm	8'6"	2540 mm	8'4"	2630 mm	8'8"	2630 mm	8'8"
H) Hinge pin height	3350 mm	11'0"	3350 mm	11'0"	3350 mm	11'0"	3350 mm	11'0"
J) Max operating height	4290 mm	14'1"	4330 mm	14'3"	4320 mm	14'2"	4320 mm	14'2"
K) Digging depth	42 mm	2"	80 mm	3"	75 mm	3"	75 mm	3"
Grading angle	109°		109°		112°		112°	
Width of dozer cutting edge	—	—	—	—	2262 mm	7'5"	2406 mm	7'11"
Clam opening — maximum	—	—	—	—	790 mm	2'7"	790 mm	2'7"
L) Reach @ full height/max dump angle	780 mm	2'7"	780 mm	2'7"	700 mm	2'4"	700 mm	2'4"
M) Maximum rollback @ groundline	39°		40°		40°		40°	
Weight	459 kg	1012 lb	473 kg	1043 lb	659 kg	1453 lb	682 kg	1504 lb

*Recommended for use with All Wheel Steer option.

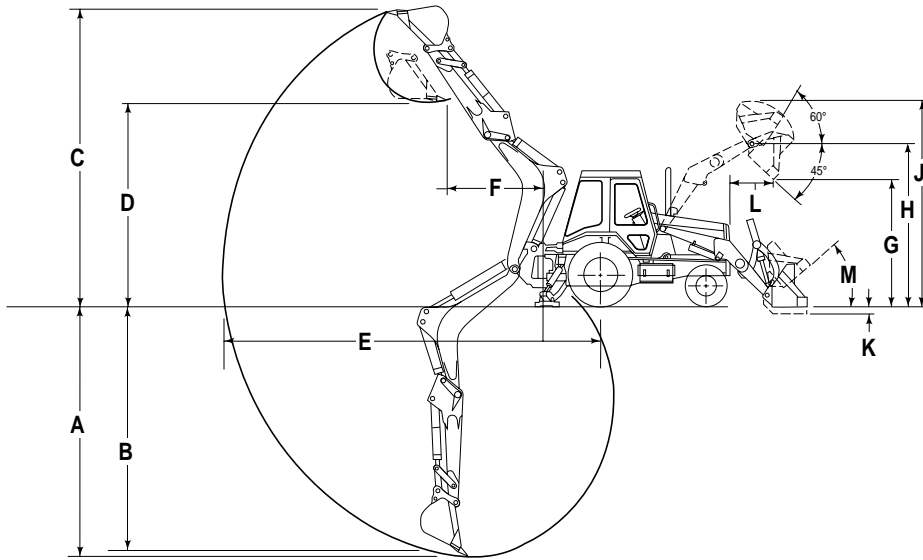

MODEL	446B					
Loader	General Purpose		General Purpose		Multi-Purpose	
Bucket capacity	1.1 m ³	1.5 yd ³	1.3 m ³	1.75 yd ³	1.05 m ³	1.375 yd ³
Width	2434 mm	8'0"	2434 mm	8'0"	2434 mm	8'0"
Lift capacity at full height	3970 kg	8760 lb	3905 kg	8610 lb	3790 kg	8350 lb
Breakout force	56 kN	12,600 lb	51.7 kN	11,610 lb	57.4 kN	12,900 lb
G) Dump height @ 45 degrees	2699 mm	8'10"	2657 mm	8'9"	2731 mm	9'0"
H) Hinge pin height	3490 mm	11'5"	3490 mm	11'5"	3490 mm	11'5"
J) Overall operating height — fully raised	4410 mm	14'3"	4198 mm	13'9"	4410 mm	14'6"
K) Digging depth	162 mm	6.4"	162 mm	6.4"	143 mm	5.6"
Grading angle	115°		115°		115°	
Width of dozer cutting edge	—	—	2434 mm	8'0"	2434 mm	8'0"
Clam opening — maximum	—	—	965 mm	3'2"	1000 mm	3'3"
L) Reach @ full height/45 degrees	868 mm	2'10"	910 mm	3'0"	868 mm	2'10"
M) Maximum rollback @ groundline	40°		40°		40°	
Weight	553 kg	1217 lb	608 kg	1338 lb	849 kg	1868 lb

NOTE: All 446B specifications are effective with S/N 5BL00500.

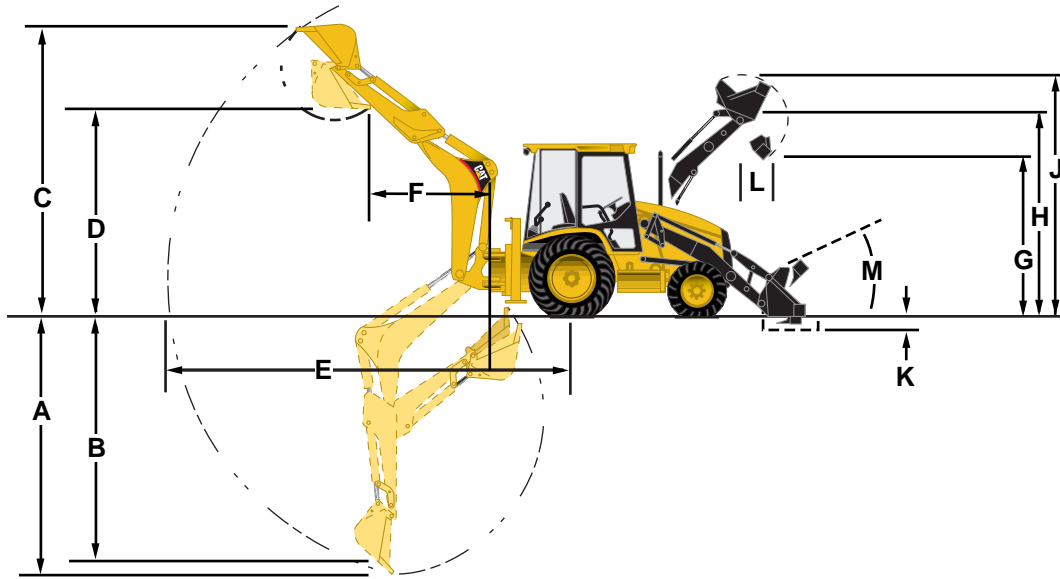

MODEL	428C							
Loader	Single Tilt				Parallel Lift			
Bucket	General Purpose		Multi-Purpose		General Purpose		Multi-Purpose	
Bucket capacity	1 m ³	1.30 yd ³	1.03 m ³	1.35 yd ³	1 m ³	1.30 yd ³	1.03 m ³	1.35 yd ³
Width	2396 mm	7'10"	2406 mm	7'11"	2396 mm	7'10"	2406 mm	7'11"
Lift capacity at full height	2340 kg	5158 lb	2145 kg	4728 lb	3295 kg	7265 lb	3060 kg	6747 lb
Breakout force	38.5 kN	8655 lb	41.1 kN	9239 lb	50.1 kN	11,262 lb	53.2 kN	11,959 lb
G) Dump height @ max dump angle	2570 mm	8'5"	2605 mm	8'6"	2565 mm	8'5"	2600 mm	8'6"
H) Hinge pin height	3270 mm	10'8"	3270 mm	10'8"	3270 mm	10'8"	3270 mm	10'8"
J) Max operating height	4150 mm	13'7"	4175 mm	13'8"	4150 mm	13'7"	4175 mm	13'8"
K) Digging depth	135 mm	5"	165 mm	7"	135 mm	5"	165 mm	7"
Grading angle	108°		111°		111°		114°	
Width of dozer cutting edge	—	—	2406 mm	7'11"	—	—	2406 mm	7'11"
Clam opening — maximum	—	—	927 mm	3'0"	—	—	927 mm	3'0"
L) Reach @ full height/max dump angle	825 mm	2'8"	745 mm	2'5"	820 mm	2'8"	735 mm	2'5"
M) Maximum rollback @ groundline	39°		40°		40°		40°	
Weight	445 kg	981 lb	700 kg	1543 lb	445 kg	981 lb	685 kg	1510 lb

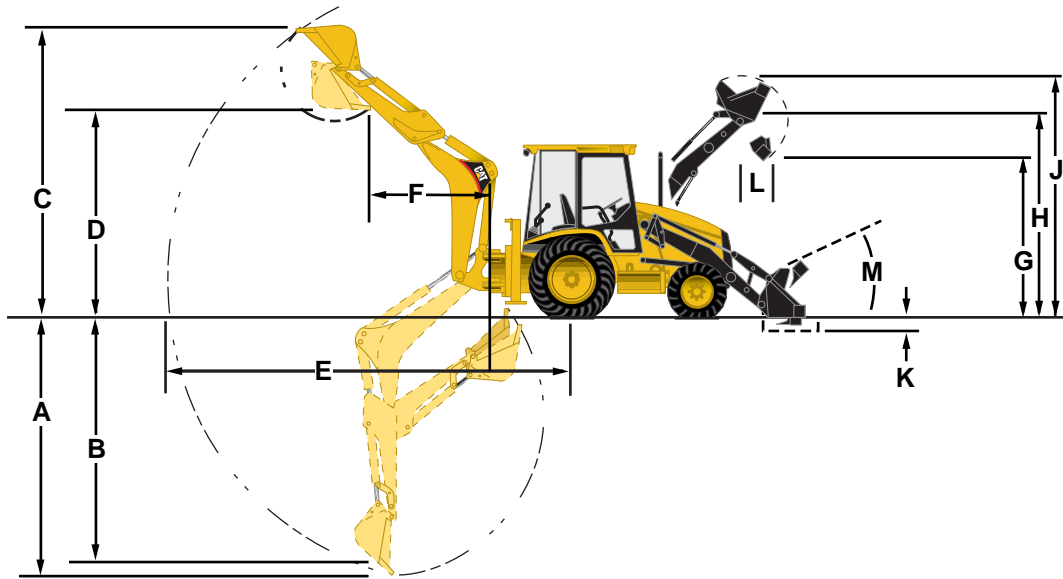

MODEL	438C					
Loader	Single Tilt					
Bucket	General Purpose		General Purpose		Multi-Purpose	
Bucket capacity	1 m ³	1.30 yd ³	1.15 m ³	1.50 yd ³	1.03 m ³	1.35 yd ³
Width	2396 mm	7'10"	2396 mm	7'10"	2406 mm	7'11"
Lift capacity at full height	2390 kg	5269 lb	2300 kg	5070 lb	2200 kg	4850 lb
Breakout force	39.3 kN	8835 lb	38 kN	8543 lb	40.4 kN	9082 lb
G) Dump height @ max dump angle	2670 mm	8'9"	2615 mm	8'7"	2700 mm	8'10"
H) Hinge pin height	3360 mm	11'0"	3360 mm	11'0"	3360 mm	11'0"
J) Max operating height	4240 mm	13'11"	4285 mm	14'1"	4270 mm	14'0"
K) Digging depth	40 mm	2"	80 mm	3"	70 mm	3"
Grading angle	110°		110°		113°	
Width of dozer cutting edge	—	—	—	—	2406 mm	7'11"
Clam opening — maximum	—	—	—	—	927 mm	3'1"
L) Reach @ full height/max dump angle	800 mm	2'7"	800 mm	2'7"	720 mm	2'4"
M) Maximum rollback @ groundline	38°		39°		38°	
Weight	445 kg	981 lb	635 kg	1400 lb	700 kg	1543 lb

Backhoe Loaders

Loader Performance Data

- General/Multi-Purpose Buckets

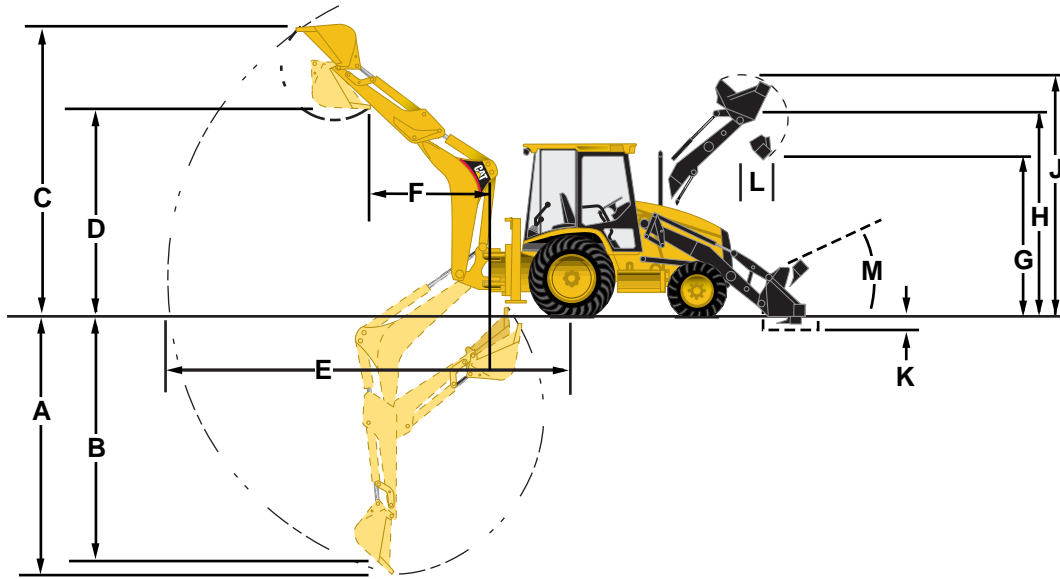

MODEL	438C					
Loader	Parallel Lift					
Bucket	General Purpose		General Purpose		Multi-Purpose*	
Bucket capacity	1 m ³	1.30 yd ³	1.15 m ³	1.50 yd ³	1.03 m ³	1.35 yd ³
Width	2396 mm	7'10"	2396 mm	7'10"	2406 mm	7'11"
Lift capacity at full height	3355 kg	7396 lb	3300 kg	7275 lb	3120 kg	6878 lb
Breakout force	50.4 kN	11,330 lb	49.4 kN	11,105 lb	53.4 kN	12,004 lb
G) Dump height @ max dump angle	2655 mm	8'9"	2600 mm	8'6"	2690 mm	8'10"
H) Hinge pin height	3360 mm	11'0"	3360 mm	11'0"	3360 mm	11'0"
J) Max operating height	4240 mm	13'11"	4285 mm	14'1"	4270 mm	14'0"
K) Digging depth	40 mm	2"	80 mm	3"	70 mm	3"
Grading angle	113°		113°		116°	
Width of dozer cutting edge	—	—	—	—	2406 mm	7'11"
Clam opening — maximum	—	—	—	—	927 mm	3'1"
L) Reach @ full height/45 degrees	780 mm	2'7"	780 mm	2'7"	700 mm	2'3"
M) Maximum rollback @ groundline	38°		39°		39°	
Weight	445 kg	981 lb	635 kg	1400 lb	685 kg	1510 lb

*Recommended for use with All Wheel Steer.

Standard Duty Buckets (SD)
416C, 428C, 438C

Width mm in	SAE Heaped Capacity		SAE Struck Capacity		Weight		No. of Teeth
	L	ft ³	L	ft ³	kg	lb	
305 12	70	2.5	60	2.0	110	243	3
457 18	127	4.5	99	3.5	130	287	4
610 24	198	7.0	156	5.5	150	331	5
762 30	255	9.5	198	7.0	165	364	5
914 36	311	11.5	227	8.0	180	397	6

Heavy Duty Buckets (HD)
416C, 426C, 436C, 428C, 438C

Width mm in	SAE Heaped Capacity		SAE Struck Capacity		Weight		* No. of Teeth
	L	ft ³	L	ft ³	kg	lb	
305 12	70	2.5	60	2.0	110	243	3
400 16	100	3.5	85	3.0	132	291	4
457 18	127	4.5	99	3.5	150	331	4
610 24	198	7.0	156	5.5	175	386	4
762 30	255	9.5	198	7.0	195	430	5
914 36	311	11.5	227	8.0	210	463	6

*Bolt-on teeth available.

High Capacity Buckets (HC)
416C, 426C, 436C, 428C, 438C

Width mm in	SAE Heaped Capacity		SAE Struck Capacity		Weight		No. of Teeth
	L	ft ³	L	ft ³	kg	lb	
457 18	184	6.5	127	4.5	155	342	4
610 24	225	9.0	184	6.5	180	397	4
762 30	311	11.0	227	8.0	200	441	5
914 36	396	14.0	283	10.0	215	474	6

Teeth Options:

Utility — Short
 Penetration — Long
 Abrasion

Extreme Service Buckets (ES)
416C, 426C, 436C, 428C, 438C

Width mm in	SAE Heaped Capacity		SAE Struck Capacity		Weight		No. of Teeth
	L	ft ³	L	ft ³	kg	lb	
457 18	99	4.0	83	3.0	145	320	4
610 24	156	6.0	140	5.0	165	364	4

Heavy Duty Buckets (HD)
446B

Width mm in	SAE Heaped Capacity		SAE Struck Capacity		Weight		No. of Teeth
	L	ft ³	L	ft ³	kg	lb	
457 18	190	6.5	170	5.9	178	392	3
610 24	280	10.0	240	8.4	216	476	4
762 30	380	13.0	300	10.5	237	523	5
914 36	480	17.0	380	13.0	267	589	6

Extreme Service Buckets (ES)
446B

Width mm in	SAE Heaped Capacity		SAE Struck Capacity		Weight		No. of Teeth
	L	ft ³	L	ft ³	kg	lb	
600 24	270	9.0	230	8.1	227	501	4
760 30	370	13.0	290	10.0	249	549	5

KEY

- A — Boom lift lb kg
- B — Stick lift lb kg

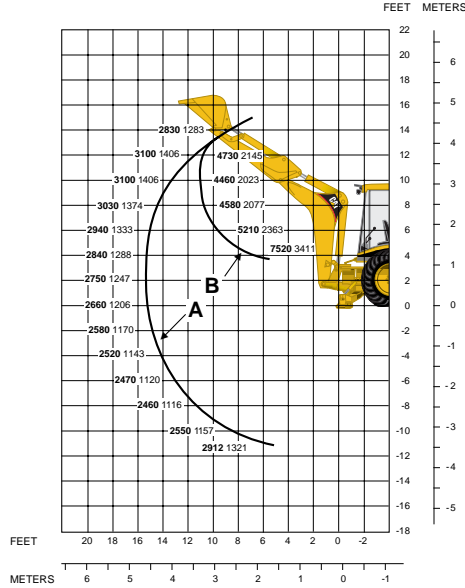

Standard Stick

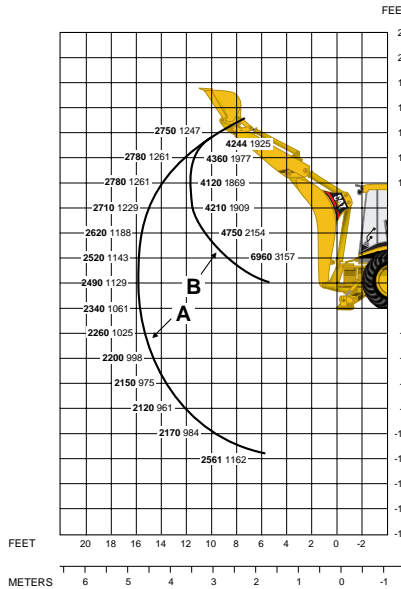

Extendible Stick —
Retracted

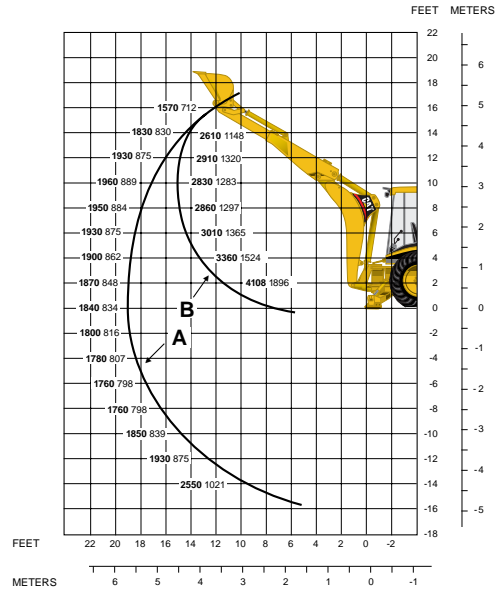

Extendible Stick —
Extended

NOTE: Boom at 65°.

Machine configuration includes 16.9X24, 8PR, R4 rear and 11LX16, 10PR, F3 front tires, open ROPS, two wheel drive, single tilt loader, 0.76 m³ (1 yd³) GP bucket, 610 mm (2'0") standard duty bucket, base counterweight 145 kg (320 lb).

KEY

- A — Boom lift lb kg
- B — Stick lift lb kg

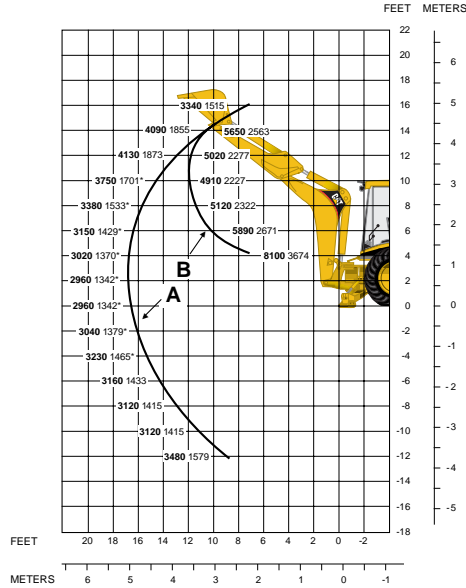

Standard Stick

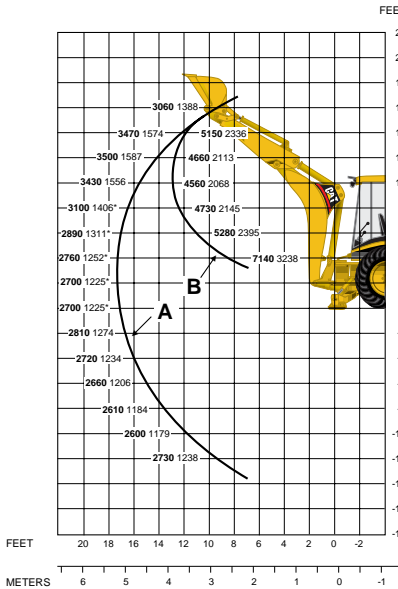

Extendible Stick — Retracted

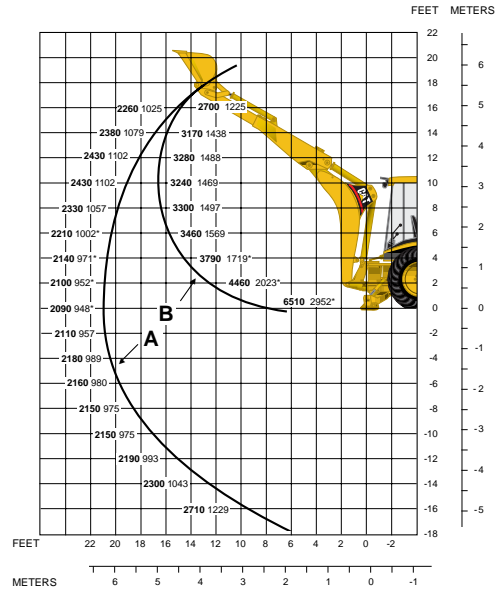

Extendible Stick — Extended

NOTE: Boom at 65°.

Machine configuration includes 16.9X24, 8PR, R4 rear and 11LX16, 12PR, F3 front tires, open ROPS, two wheel drive, single tilt loader, 0.96 m³ (1.25 yd³) GP bucket, 610 mm (2'0") heavy duty bucket, base counterweight 145 kg (320 lb) plus 1 add on 105 kg (231 lb).

KEY

- A — Boom lift **lb** kg
- B — Stick lift **lb** kg

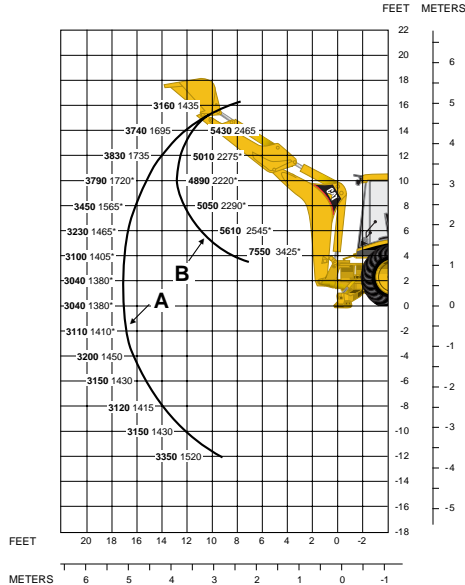

Standard Stick

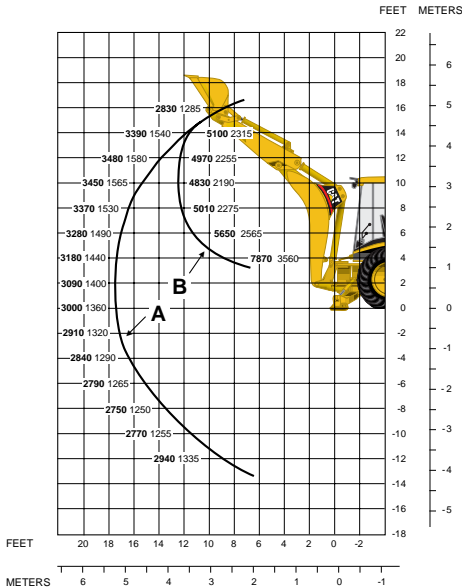

Extendible Stick —
Retracted

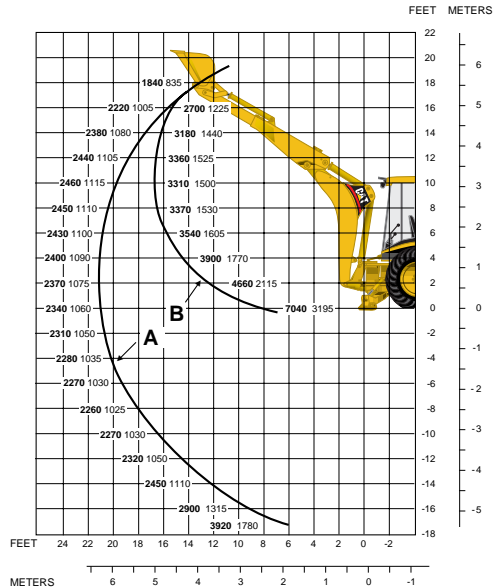

Extendible Stick —
Extended

NOTE: Boom at 65°.

Machine configuration includes 11L-16, 12PR, F3 front and 19.5LX24, 10PR, IT525 rear tires, open ROPS, two wheel drive, single tilt loader, 1.07 m³ (1.4 yd³) GP bucket, 610 mm (2'0") high capacity bucket, base counterweight 145 kg (320 lb) plus 1 add on 105 kg (231 lb).

*Indicates lift capacity is stability limited.

KEY

- A — Boom lift **lb kg**
- B — Stick lift **lb kg**

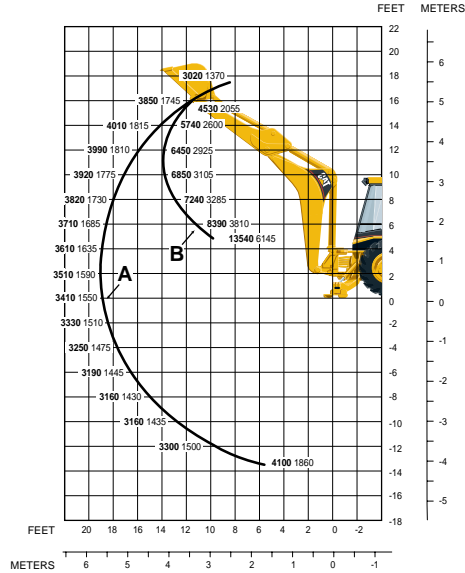

Standard Stick*

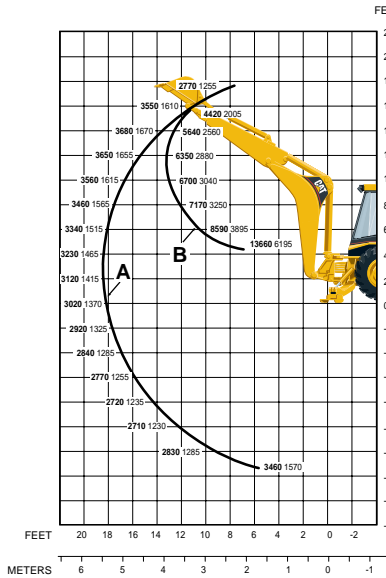

Extensible Stick** — Retracted

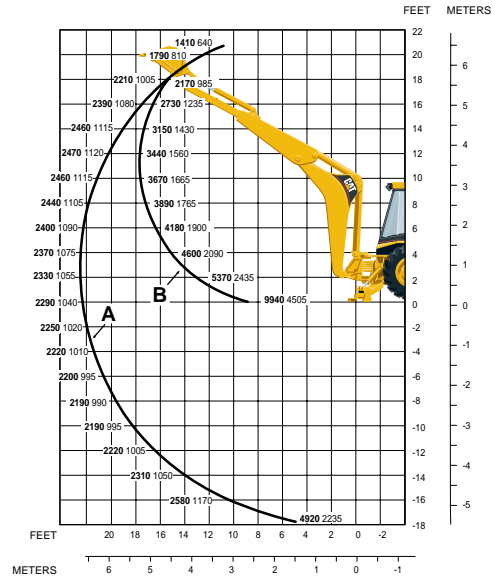

Extensible Stick** — Extended

NOTE: Boom at 65°.

*With 455 kg (1000 lb) counterweight.

**With 680 kg (1500 lb) counterweight.

KEY

- A — Boom lift lb kg
- B — Stick lift lb kg

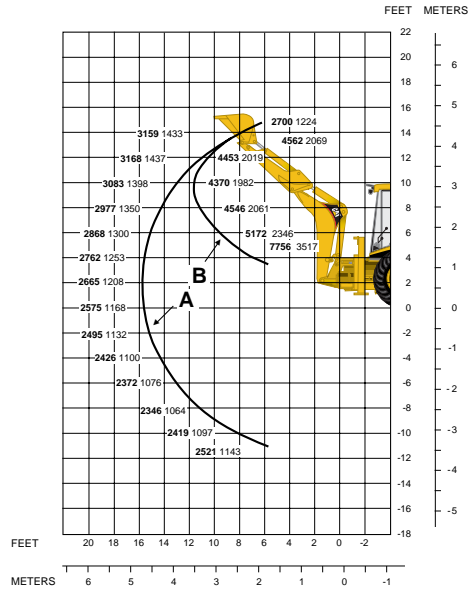

Standard Stick

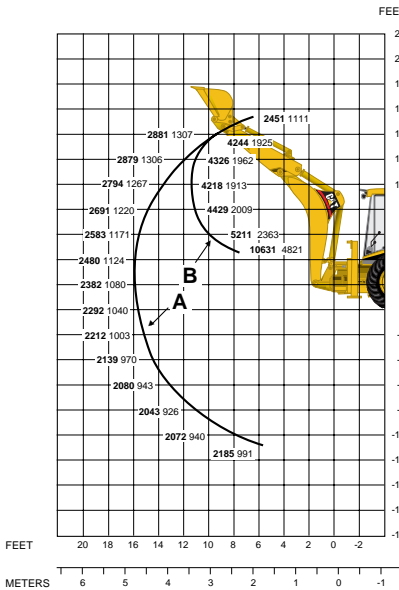

Extendible Stick —
Retracted

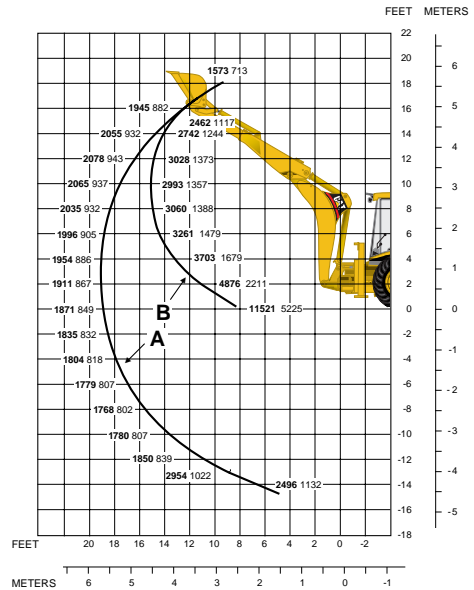

Extendible Stick —
Extended

NOTE: Boom at 65°.

Machine configuration includes 11LX16 12PR, F-3 laborer front and 16.9X28, 10PR, R4 rear tires, cab, two wheel drive, parallel lift loader, 1 m³ (1.3 yd³) GP bucket, 610 mm (2'0") heavy duty bucket, base counterweight 16 kg (35 lb).

KEY

- A — Boom lift **lb kg**
- B — Stick lift **lb kg**

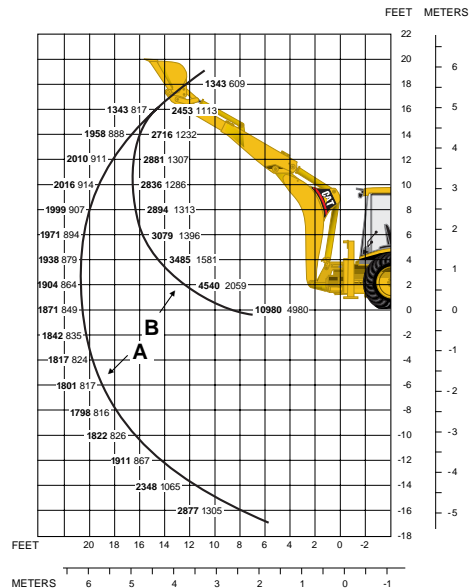
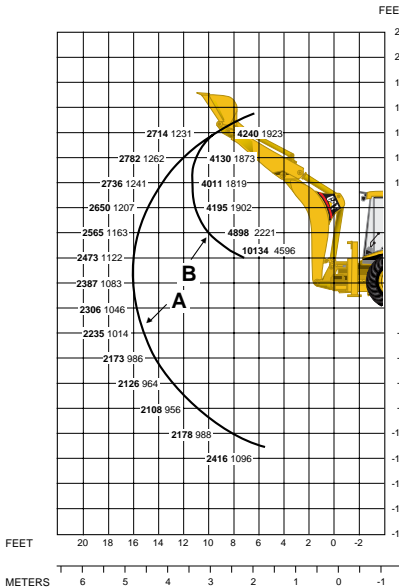
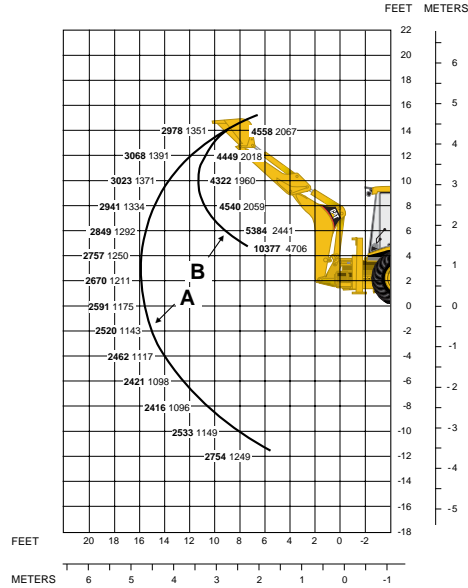

NOTE: Boom at 65°. Machine configuration includes 12.5/80X18 10PR, I-3 implement front and 18.4/15X26, 12PR, R4 rear tires, cab, all wheel drive, parallel lift loader, 1 m³ (1.3 yd³) GP bucket, 610 mm (2'0") heavy duty bucket, base counterweight 16 kg (35 lb).

Dimensions	Centerpivot					
	416C		426C		436C	
Overall transport length	6890 mm	22'7"	7260 mm	23'10"	7300 mm	23'11"
Overall length (loader on ground)	6870 mm	22'6"	7280 mm	23'11"	7295 mm	23'11"
Overall transport height	3585 mm	11'9"	3770 mm	12'4"	3750 mm	12'4"
Overall width, without bucket	2235 mm	7'4"	2235 mm	7'4"	2235 mm	7'4"
Height to top of cab	2850 mm	9'4"	2850 mm	9'4"	2870 mm	9'5"
Height to top of stack	2670 mm	8'9"	2670 mm	8'9"	2710 mm	8'11"
Height to top of steering wheel	1940 mm	6'4"	1940 mm	6'4"	1965 mm	6'5"
Ground clearance (minimum)	297 mm	12"	291 mm	12"	352 mm	14"
Rear axle centerline to front grill	2660 mm	8'9"	2660 mm	8'9"	2660 mm	8'9"
Front wheel tread	1780 mm	5'10"	1977 mm	6'4"	1828 mm	6'0"
Rear wheel tread	1714 mm	5'8"	1714 mm	5'8"	1714 mm	5'8"
Wheel base: (2WD)	2100 mm	6'11"	2100 mm	6'11"	2100 mm	6'11"
(4WD)	2100 mm	6'11"	2100 mm	6'11"	2100 mm	6'11"

Dimensions	Centerpivot		Sideshift			
	446B		428C		438C	
Overall transport length	7954 mm	26'1"	5760 mm	18'11"	5740 mm	18'10"
Overall length (loader on ground)	7922 mm	26'0"	5710 mm	18'9"	5665 mm	18'7"
Overall transport height	4193 mm	13'9"	3740 mm	12'3"	3765 mm	12'4"
Overall width, without bucket	2434 mm	8'0"	2392 mm	7'10"	2392 mm	7'10"
Height to top of cab	2864 mm	9'5"	2900 mm	9'6"	2900 mm	9'6"
Height to top of stack	2960 mm	9'9"	2700 mm	8'10"	2750 mm	9'0"
Height to top of steering wheel	2111 mm	6'11"	1940 mm	6'4"	1940 mm	6'4"
Ground clearance (machine main frame)	332 mm	13"	320 mm	13"	335 mm	13"
Rear axle centerline to front grill	2752 mm	9'0"	2613 mm	8'7"	2620 mm	8'7"
Front wheel tread	1970 mm	6'6"	1780 mm	5'10"	1780 mm	5'10"
Rear wheel tread	1800 mm	5'11"	1714 mm	5'7"	1714 mm	5'7"
Wheel base: (2WD)	2233 mm	7'4"	2100 mm	6'11"	2100 mm	6'11"
(4WD)	2233 mm	7'4"	2100 mm	6'11"	2100 mm	6'11"

Loader End Work Tools	446B	436C	428C	426C	416C
Quick coupler	X	X	X	X	X
General purpose bucket	X	X	X	X	X
Light material bucket	X	X	X	X	X
Multi-purpose bucket	X	X	X	X	X
Pallet fork	X	X	X	X	X
Hydraulic angle blade	X	X	X	X	X
Hydraulic broom	X	X	X	X	X
Asphalt cutter	X	X	X	X	X
Loader rake	X	X	X	X	X
Side dump bucket	X	X	X	X	X

Stick End Work Tools	446B	436C	428C	426C	416C
Ditch cleaning bucket	X	X	X	X	X
Heavy duty bucket	X	X	X	X	X
Extreme service bucket	X	X	X	X	X
Hydraulic hammer	X	X	X	X	X
Vibratory plate compactor	X	X	X	X	X

This list is not all-inclusive. Contact Caterpillar Special Attachments for special attachment needs.

WHEEL SKIDDERS TRACK SKIDDERS

CONTENTS

WHEEL SKIDDERS

Features	.6-1
Specifications	.6-2
Rimpull and speed	.6-3
Grapple Information:	
SAE specification definition	.6-5
Single-function grapples	.6-6
Dual-function grapples	.6-7
Swing-boom	.6-8

TRACK SKIDDERS

Features	.6-9
Specifications	.6-10
Drawbar pull and speeds	.6-11
Grapples	.6-13
Swing-boom	.6-14

525/515 Features:

- **Proven Cat 3304 diesel engine.** 515 is turbocharged; 525 is turbocharged and aftercooled.
- **4 speed powershift transmission** ... provides better match of engine power to skidding requirements.
- **Long wheelbase** for stability with large grapple loads and uphill skidding.
- **Front Axle Cradle oscillation** — helps improve tractor stability with grapples and provides excellent ride for operator.
- **Enclosed oil disk brakes**, sealed, adjustment free, and fade resistant.

- **Load Sensing Hydraulic System** — variable displacement pressure compensating hydraulic system provides reduced power requirements when there is no hydraulic demand, significantly reduced heat generation.
- **Single, dual-function arch, swing-boom (525) and cable skidder** options available to meet various logging requirements.
- **Outstanding operator environment** superior visibility, logical control placement, and significantly reduced hydraulic, steering and transmission control efforts. ROPS structures meets OSHA regulations for roll-over and falling object.
- **Easy servicing** — minimal daily requirements, grouped and accessible grease fittings, accessible hydraulic oil sight gauges, engine oil dipstick and fuel cap.

528B Features:

- **Proven Cat 3306 Turbocharged diesel engine** provides power and outstanding durability and reliability.
- **Frame oscillation** for excellent side hill stability.
- **Caliper disk brakes** — reliable and easy to service.
- **Protection for operator and machine** — ROPS structures and guarding provide operator and machine protection in the most severe logging environments.



MODEL	515		525		528B	
Flywheel Power	104 kW	140 hp	118 kW	160 hp	138/145 kW	185/195 hp
Operating Weight	12 700 kg	27,940 lb	15 200 kg	33,500 lb	15 550 kg	34,210 lb
Engine Model	3304		3304		3306	
Rated Engine RPM	2200		2200		2200	
No. Cylinders	4		4		6	
Displacement	7 L	425 in ³	7 L	425 in ³	10.5 L	638 in ³
Oscillation, Type	front axle cradle		front axle cradle		frame (center hitch)	
Oscillation, degrees	±15°		±15°		±14°	
Tires, standard	23.1-26		23.1-26		24.5-32	
optional	28L-26 67/34-25 66/43-25		28L-26 67/34-25 66/43-25 73/44-32		30.5-32	
Turning Diameter (outside rear wheel)*	5.532 m	36'6"	11.4 m	37'5"	11.86 m	38'10"
Heavy Duty Winch Line Pull, max. at stall, bare drum	13 608 kg	30,000 lb	19 500 kg	43,000 lb	18 140 kg	40,000 lb
Line Speed at Rated Engine RPM, full drum	97.5 m/min	300 fpm	101 m/min	333 fpm	113 m/min	370 fpm
Winch Weight	522 kg	1150 lb	522 kg	1150 lb	522 kg	1150 lb
Drum Capacity,						
Standard — 5/8 (16 mm)	96 m	315'0"	96 m	315'0"	66 m	216'0"
Optional — 3/4 (19 mm)	66 m	216'0"	65 m	213'0"	96 m	315'0"
Flange Diameter	495 mm	1'7.5"	495 mm	1'7.5"	495 mm	1'7.5"
Drum Width	200 mm	7.88"	200 mm	7.88"	200 mm	7.88"
Drum Diameter	305 mm	12"	305 mm	12"	305 mm	12"
Fuel Tank Refill Capacity	185 L	48 U.S. gal	258 L	68 U.S. gal	208 L	55 U.S. gal
Hydraulic Retrieval Device						
Line Pull, max at stall, bare drum	88 kN	19,800 lb	88 kN	19,800 lb		—
Line Speed at Rated Engine RPM, bare drum	29.25 m/min	96 fpm	29.25 m/min	96 fpm		—
HRD Weight	499 kg	1100 lb	499 kg	1100 lb		—
Drum Capacity — 5/8 (16 mm)	67 m	18'4"	67 m	18'4"		—
Drum Diameter	254 mm	10"	254 mm	10"		—
Hydraulic System Refill Capacity	75 L	19.5 U.S. gal	74 L	19.5 U.S. gal	75 L	19.5 U.S. gal
GENERAL DIMENSIONS*						
Length with Dozer @ ground	5.8 m	19'0"	6.00 m	19'8"	6.76 m	22'2"
Wheelbase	3.30 m	10'10"	3.50 m	11'6"	3.25 m	10'8"
Width over Tires*	2.72 m	9'0"	3.13 m	10'3"	2.96 m	9'9"
Height to Top of ROPS	3.03 m	9'11.5"	3.05 m	10'0"	3.07 m	10'1"
Height to Exhaust	3.07 m	10'1"	3.09 m	10'1.5"	3.13 m	10'3"
Ground Clearance*	457 mm	18"	527 mm	1'8.7"	610 mm	2'0"
Tread Width*	2.10 m	6'11"	2.39 m	7'10"	2.34 m	7'8"
Dozer Width	2.16 m	7'1"	2.16 m	7'1"	2.29 m	7'6"

*With standard tires.

515 Skidder

kg x 1000 lb x 1000

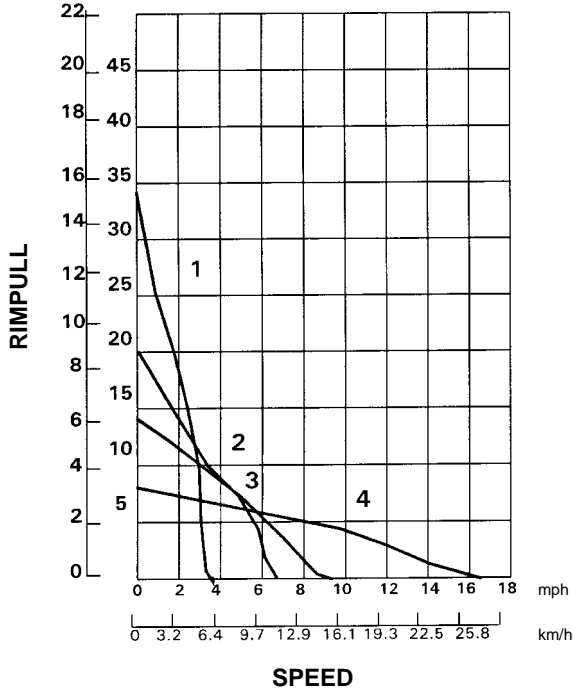

525 Skidder

kg x 1000 lb x 1000

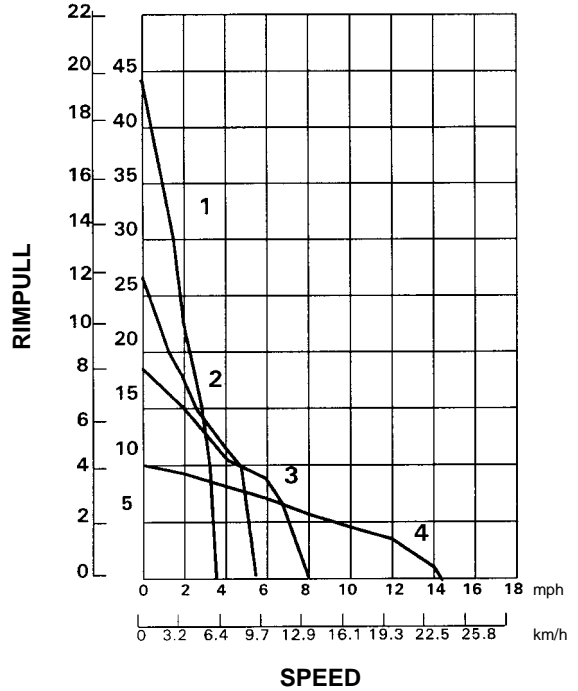

6

KEY
 1 — 1st Gear
 2 — 2nd Gear
 3 — 3rd Gear
 4 — 4th Gear

	1st	2nd	3rd	4th
Forward, km/h	6.21	10.63	15.00	27.15
mph	3.86	6.61	9.32	16.87
Reverse, km/h	6.21	10.63	19.22	—
mph	3.86	6.61	11.95	—

	1st	2nd	3rd	4th
Forward, km/h	5.37	9.2	12.97	23.5
mph	3.34	5.72	8.06	14.6
Reverse, km/h	5.37	9.2	16.64	—
mph	3.34	5.72	10.34	—

Usable rimpull depends on traction, tire size and equipped weight of loaded machines. Grapple weights may vary.
NOTE: Rimpull shown with 28L-26 tires. Consult your Caterpillar Dealer for further information.

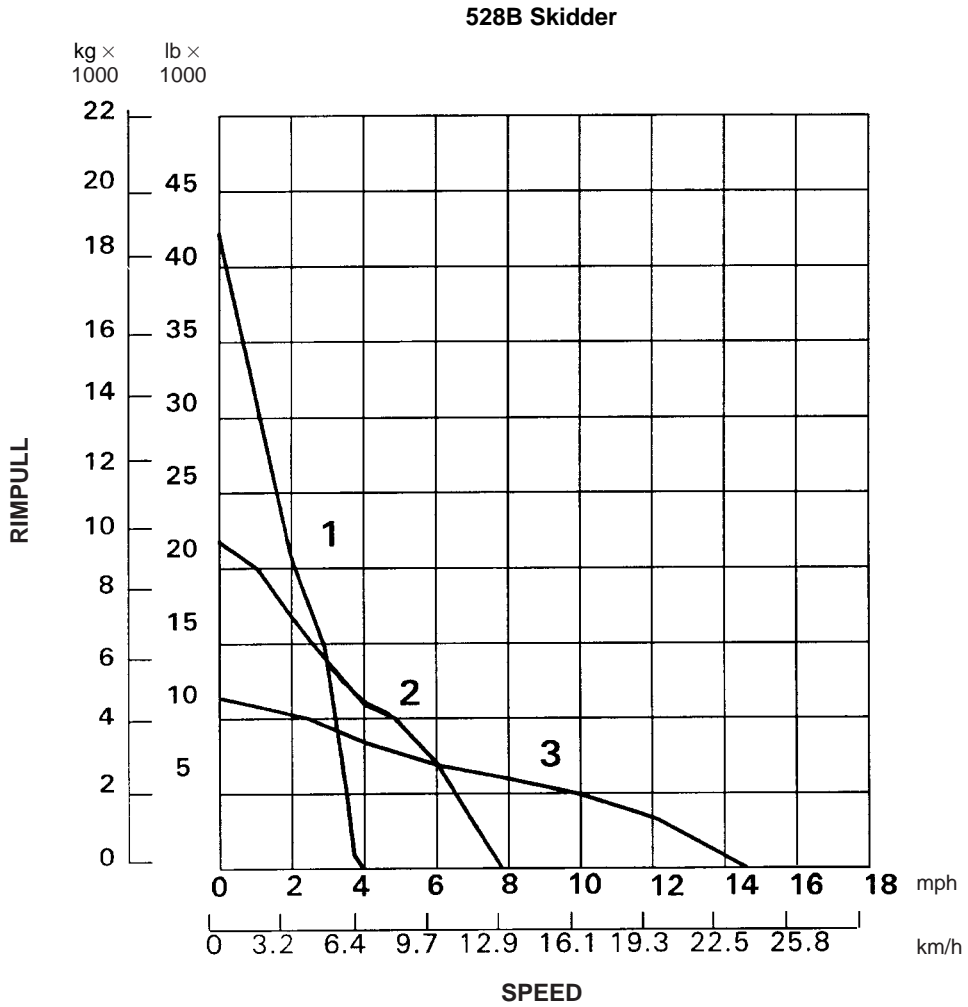

- KEY**
- 1 — 1st Gear
 - 2 — 2nd Gear
 - 3 — 3rd Gear

NOTE: Usable pull will depend upon weight and traction of equipped tractor.

GRAPPLES

Grapples for Cat 515 and 525 Skidders are built by independent manufacturers of auxiliary equipment (AEMS) to Caterpillar specifications. All fixed and swing grapples are factory installed and supplied by Caterpillar. The following pages contain information on the available models, which are presented here to suggest a range of grapple possibilities. The specifications were supplied by the manufacturer and follow the SAE definitions listed below.

SAE specification definition

Reach (A, B, C, D) — The horizontal distance from the vertical center of the rear axle to the vertical center of the grapple fore and aft pivot.

- A) With the grapple in its highest farthest position
- B) With the grapple in its lowest farthest position
- C) With the grapple in its highest fully retracted position
- D) With the grapple in its lowest fully retracted position

Lift (E, F, G, H) — The vertical distance from the horizontal center of the rear axle to the horizontal center of the grapple fore and aft pivot.

- E) With the grapple in its highest farthest position
- F) With the grapple in its lowest farthest position
- G) With the grapple in its highest fully retracted position
- H) With the grapple in its lowest fully retracted position

Loaded Tire Radius (J) — Vertical distance from horizontal center of axle to horizontal reference plane.

Maximum Grapple Opening (K) — The horizontal distance between the tips of the grapple arms when grapple is fully open.

Area of Opening (L) — The available area with grapple in tips together position.

Minimum Log Size (M) — The smallest diameter which the grapple can close on.

Grapple Length (N, O, P) — The distance from the grapple fore and aft pivot to tips of grapple arms.

- N) With grapple fully open
- O) With grapple in tips together position
- P) With grapple fully closed

Single-function arch

- Versatile attachment suitable for selection or clear cut applications. Reach consists of one vertical arc and typical application is short cycles and/or larger diameter timber.

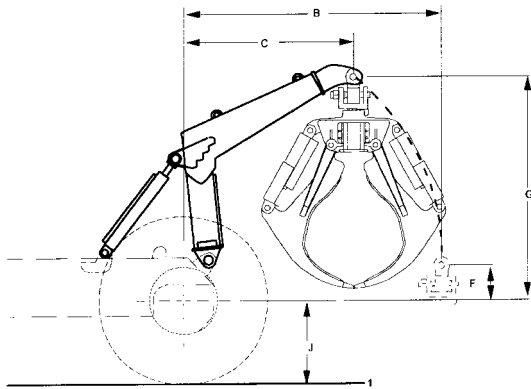

- KEY**
- 1 — Horizontal Reference Plane
 - 2 — Fully Open
 - 3 — Tip to Tip
 - 4 — Fully Closed

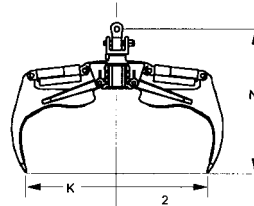

Sorting grapple is designed to pick up individual or several stems for quick cycles of 305 mm (12") or larger diameter trees.

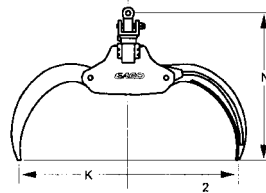
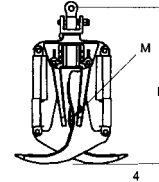
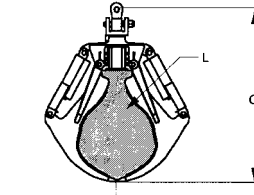

Bunching grapple is designed to gather bundled stems and maximize grapple loads of 305 mm (12") or smaller diameter trees.

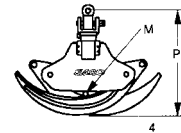
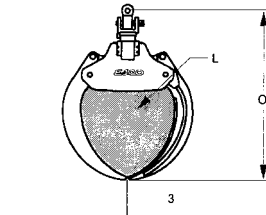

Grapples for 515		B	C	F	G	J	K	M	N	O	P	L
84" Sorting	mm	2140	1323	515	223	724	2130	76	1680	1980	1740	0.74 m ²
	in	84.3	52.0	20	8	28.5	84	3	66	78	68.5	8 ft ²
90" Bunching	mm	2140	1323	515	223	724	2290	102	1640	1920	1310	0.74 m ²
	in	84.3	52.0	20	8	28.5	90	4	64	75	51	8 ft ²
Grapples for 525		B	C	F	G	J	K	M	N	O	P	L
100" Sorting	mm	2517.1	1662.2	342.9	2169.2	737	2540.0	76.2	1562.1	2044.7	1828.8	0.84 m ²
	in	99.1	65.4	13.5	85.4	29	100.0	3.0	61.5	80.5	72.0	9 ft ²
110" Bunching	mm	2517.1	1662.2	342.9	2169.2	737	2794.0	76.2	1879.6	2171.7	1358.9	1.04 m ²
	in	99.1	65.4	13.5	85.4	29	110.0	3.0	74.0	85.5	53.5	11.2 ft ²

Dual-function arch

- Extended range provides extra reach for grabbing large bundles of feller bunched, small diameter logs.
- Ability to position load closer to tractor for improved stability and traction.
- Typical applications include longer cycles and smaller diameter bunched timber.

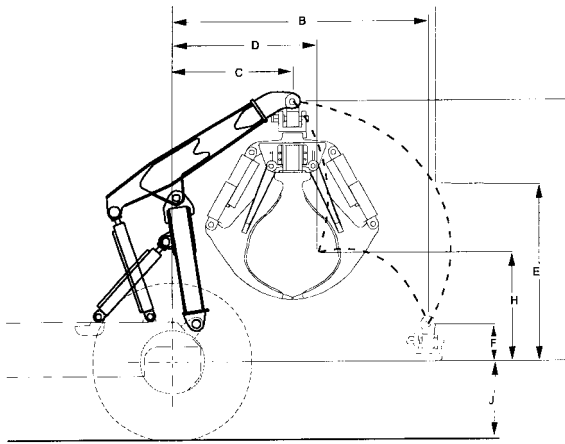

- KEY**
- 1 — Horizontal Reference Plane
 - 2 — Fully Open
 - 3 — Tip to Tip
 - 4 — Fully Closed

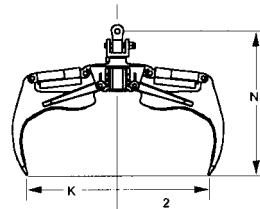

Sorting grapple is designed to pick up individual or several stems for quick cycles of 305 mm (12") or larger diameter trees.

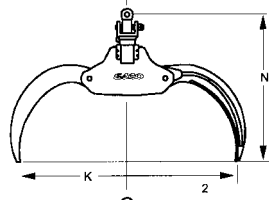
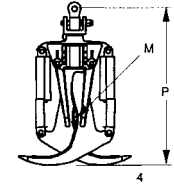
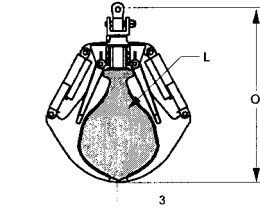

Bunching grapple is designed to gather bundled stems and maximize grapple loads of 305 mm (12") or smaller diameter trees.

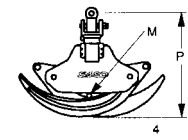
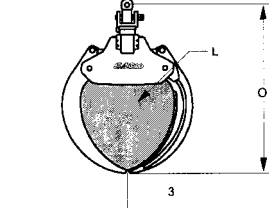

Grapples for 525

		A	B	C	D	E	F	G	H	J	K	M	N	O	P	L
100" Sorting	mm	2725.4	2654.3	1242.1	1491.0	1828.8	378.5	2694.9	1125.2	731.5	2540.0	76.2	1562.1	2044.7	1828.8	0.84 m ²
	in	107.3	104.5	48.9	58.7	72.0	14.9	106.1	44.3	28.8	100.0	3.0	61.5	80.5	72.0	9 ft ²
110" Bunching	mm	2725.4	2654.3	1242.1	1491.0	1828.8	378.5	2694.9	1125.2	731.5	2794.0	76.2	1879.6	2171.7	1358.9	1.04 m ²
	in	107.3	104.5	48.9	58.7	72.0	14.9	106.1	44.3	28.8	110.0	3.0	74.0	85.5	53.5	11.2 ft ²
120" Bunching	mm	2725.4	2654.3	1242.1	1491.0	1828.8	378.5	2694.9	1125.2	731.5	3048.0	203.2	1778.0	2235.2	1574.8	1.16 m ²
	in	107.3	104.5	48.9	58.7	72.0	14.9	106.1	44.3	28.8	120.0	8.0	70.0	88.0	62.0	12.5 ft ²

Swing-boom

- Ability to reach and lift over the side to collect scattered logs.
- Has decking and loading capability.
- Excellent reach to the rear and side for maximum skidder versatility.

- Suitable for hard to reach timber on steep slopes, soft ground, or selection harvest and thinning.
- Reduces cycle times by reducing the amount of maneuvering of the skidder to reach logs.

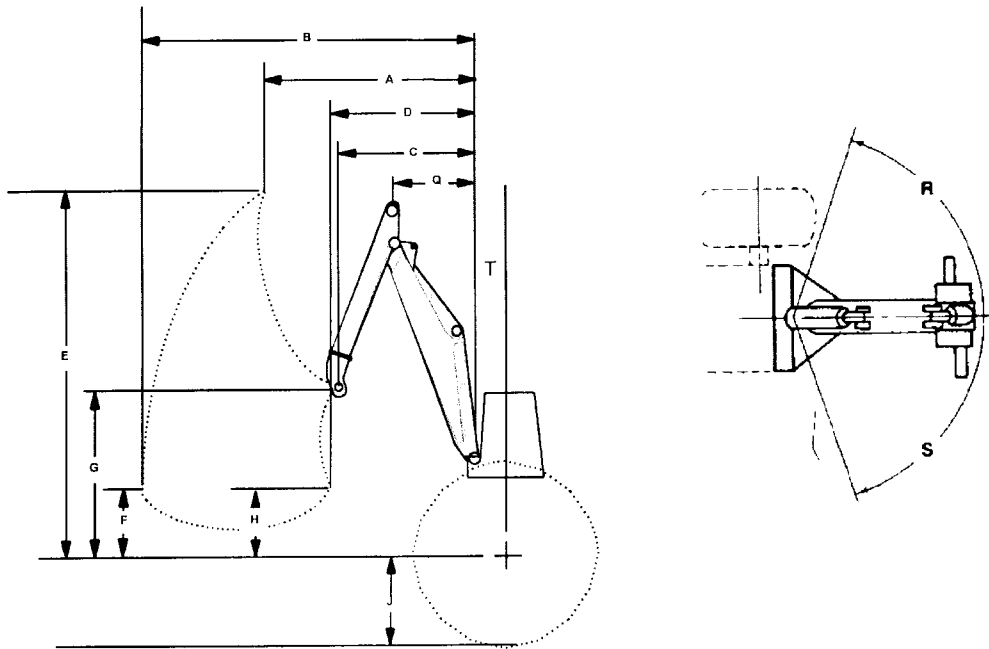

Grapples for 525 with Swing-boom

		A	B	C	D	E	F	G	H	J	Q	R	S	T
100" Sorting	mm	2257	3705	1365	1410	3818	500	1671	127	737	904	70°	70°	207
	in	89	146	54	56	150	20	66	5	29	35.6			8

TRACK SKIDDERS

CONTENTS

Features	6-9
Specifications	6-10
Power shift drawbar pull vs. ground speed charts	6-11
Grapple information	6-13

Features 517 and 527:

- **Exceptional balance** — roller frames extended to rear significantly improves traction capability under heavy loads and uphill skidding applications.
- **Excellent ground clearance** — no diagonal braces allow tractor to pass over stumps and debris, reduces maneuvering for reduced cycle times and minimizes soil impact. Smooth belly pans are also less likely to hang up in mud or debris in soft ground or swamp logging applications.
- **Outstanding sidehill stability** — wide gauge and long track roller frames provide excellent sidehill capability.
- **Improved flotation** — more track on ground distributes tractor weight and propulsion forces over a much larger area than conventional track skidders or wheel skidders. This improves flotation capabilities, gradeability and significantly reduces soil impact.
- **Superior component durability** — final drives are raised above the work area, isolating the powertrain from ground impact shock loads and abrasive materials.
- **Outstanding reliability and durability** — built to handle the toughest logging conditions.



MODEL	517 Cable		517 Grapple		527 Cable		527 Grapple	
Flywheel Power	89 kW	120 hp	89 kW	120 hp	112 kW	150 hp	112 kW	150 hp
Operating Weight*	17 330 kg	38,200 lb	18 350 kg	40,450 lb	17 236 kg	38,000 lb	21 380 kg	47,140 lb
Engine Model	3304 DIT		3304 DIT		3304		3304	
Rated Engine RPM	2200		2200		2200		2200	
No. of Cylinders	4		4		4		4	
Bore	121 mm	4.75"	121 mm	4.75"	121 mm	4.75"	121 mm	4.75"
Stroke	152 mm	6"	152 mm	6"	152 mm	6"	152 mm	6"
Displacement	7 L	425 in³	7 L	425 in³	7 L	425 in³	7 L	425 in³
Track Rollers (Each Side)	8		8		7		7	
Width of Standard Track Shoe	660 mm	2'2"	660 mm	2'2"	560 mm	1'10"	560 mm	1'10"
Length of Track on Ground	2.91 m	9'7"	2.91 m	9'7"	2.85 m	9'4"	2.85 m	9'4"
Ground Contact Area (W/Std. Shoe)	3.52 m ²	5458 in²	3.52 m ²	5458 in²	3.19 m ²	4940 in²	3.19 m ²	4940 in²
Track Gauge	2 m	6'7"	2 m	6'7"	2.16 m	7'1"	2.16 m	7'1"
GENERAL DIMENSIONS:								
Height (To Top of ROPS)	2.48 m	8'1"	2.48 m	8'1"	3.30 m	10'10"	3.30 m	10'10"
Overall Length (With Blade)	4.97 m	16'4"	5.75 m	18'10"	4.94 m	16'3"	6.07 m	19'11"
(Without Blade)	4.10 m	13'5"	4.87 m	16'0"	4.35 m	14'3"	5.6 m	18'5"
Width (W/O Trunnion)	2.91 m	9'7"	2.91 m	9'7"	2.72 m	8'11"	2.72 m	8'11"
Ground Clearance	635 mm	2'1"	635 mm	2'1"	531.8 mm	1'8.9"	531.8 mm	1'8.9"
PAT Blade Widths:								
Straight	2.74 m	9'0"	2.74 m	9'0"	3.35 m	11'0"	3.17 m	10'5"
Angle	2.48 m	8'1"	2.48 m	8'1"	3.10 m	10'2"	2.92 m	9'7"
Fuel Tank Capacity	260 L	69 U.S. gal	260 L	69 U.S. gal	256 L	67 U.S. gal	256 L	67 U.S. gal
Winch								
Line Pull, max at stall, bare drum**	31 260 kg	68,780 lb	31 260 kg	68,780 lb	31 389 kg	69,200 lb	31 389 kg	69,200 lb
Line Speed at Rated Engine RPM, bare drum**	40.5 m/min	133 fpm	40.5 m/min	133 fpm	44 m/min	143 fpm	44 m/min	143 fpm
Winch Weight	1500 kg	3300 lb	1500 kg	3300 lb	1500 kg	3300 lb	1500 kg	3300 lb
Drum Capacity: Recommended	122 m	400'0"	122 m	400'0"	122 m	400'0"	122 m	400'0"
Optional	88 m	290'0"	88 m	290'0"	88 m	290'0"	88 m	290'0"
Cable Size: Recommended	19 mm	0.75"	19 mm	0.75"	19 mm	0.75"	19 mm	0.75"
Optional	22 mm	0.88"	22 mm	0.88"	22 mm	0.88"	22 mm	0.88"
Drum Diameter	254 mm	10"	254 mm	10"	254 mm	10"	254 mm	10"

*All models include coolant, lubricants, full fuel tank, and operator.

517 Cable includes enclosed cab and 4PAT blade.

517 Grapple includes enclosed cab, 4PAT blade, swing boom, and 0.74 m² (8 ft²) grapple.

527 Cable includes lubricants, coolant, ROPS Canopy, 100% Fuel, operator, 5A blade, open cab, and towing winch.

527 Grapple includes lubricants, coolant, ROPS Canopy, 100% Fuel, operator, 5P blade, track roller guard, 660 mm (2'2") tri-link track, Swing Grapple, 100° Sorting head, and enclosed cab.

**With 22 mm (0.88") cable.

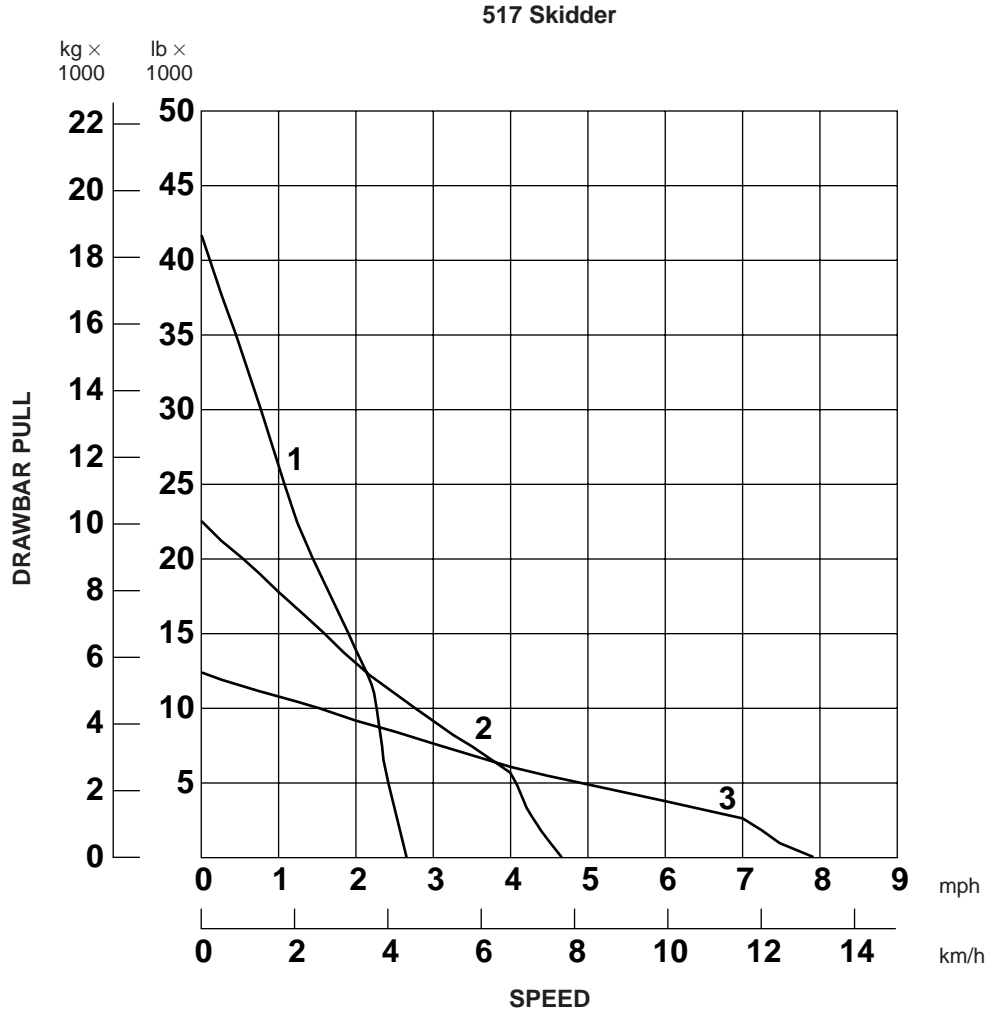

- KEY**
- 1 — 1st Gear
 - 2 — 2nd Gear
 - 3 — 3rd Gear

NOTE: Usable pull will depend upon weight and traction of equipped tractor.

527 Skidder

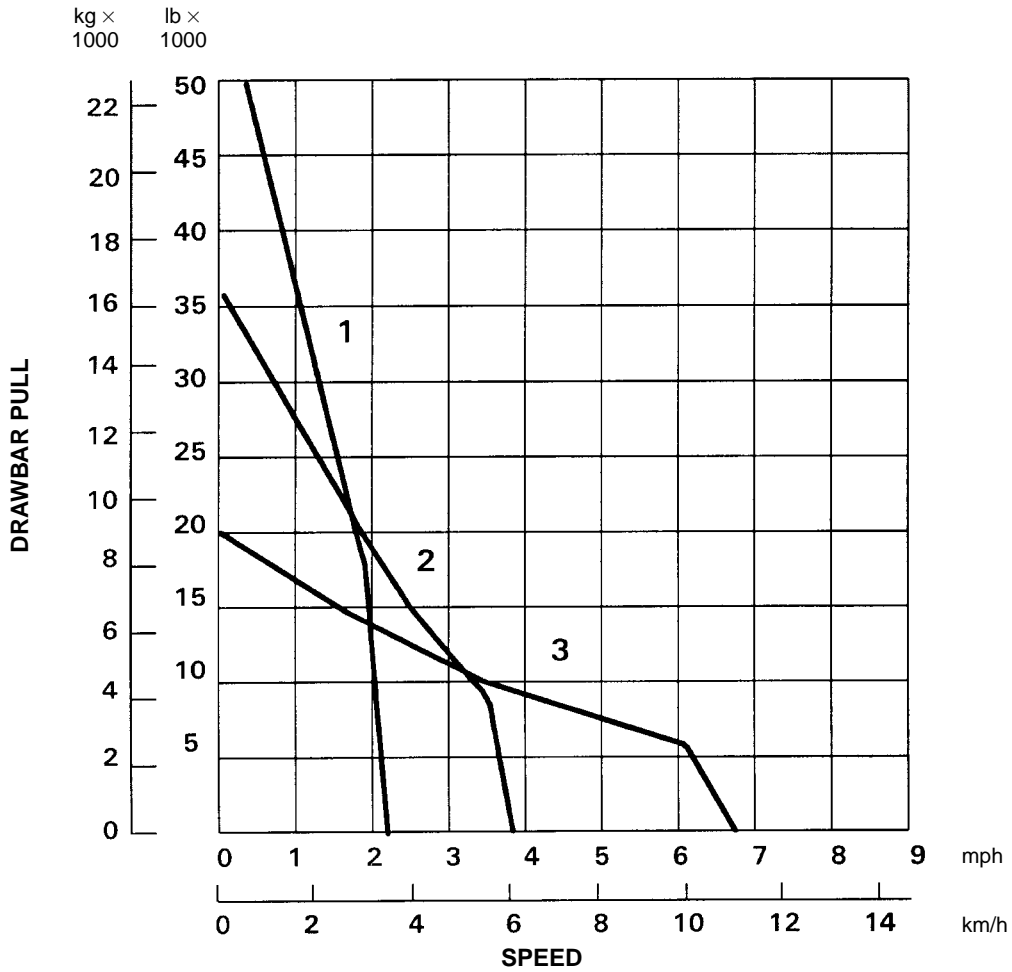

- KEY
- 1 — 1st Gear
 - 2 — 2nd Gear
 - 3 — 3rd Gear

NOTE: Usable pull will depend upon weight and traction of equipped tractor.

GRAPPLES

Fixed boom Grapples for Cat 517 and 527 Skidders are built and supplied by Caterpillar. Swing boom grapples are built by independent manufacturers of auxiliary equipment (AEMS) to Caterpillar specifications. The following contains information on some of the available models, which are presented here to suggest a range of grapple possibilities.

Reach (A, B) — The horizontal distance from the vertical center of the rear idler to the vertical center of the grapple fore and aft pivot.

- A) With the grapple in its lowest fully extended position.
- B) With the grapple in its highest fully retracted position.

Lift (C, E) — The vertical distance from the ground to the center of the grapple fore and aft pivot.

- C) With the grapple in its lowest fully extended position.
- E) With the grapple in its highest fully retracted position.

Maximum Grapple Opening (K) — The horizontal distance between the tips of the grapple arms when grapple is fully open.

Area of Opening (L) — The available area with grapple in tips together position.

Minimum Log Size (M) — The smallest diameter which the grapple can close.

Grapple Length (N, O, P) — The distance from the grapple fore and aft pivot to tips of grapple arms.

- N) With grapple fully open.
- O) With grapple in tips together position.
- P) With grapple fully closed.

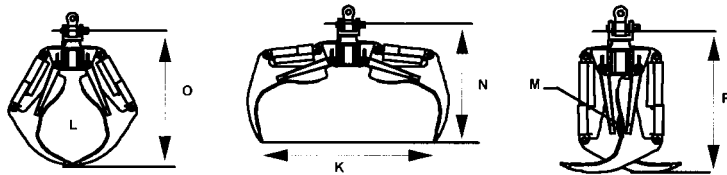

Sorting Grapple

- Used for 305 mm (12") or larger diameter trees.
- Designed to pick up individual or several stems for quick cycles.

Bunching Grapple

- Used for 305 mm (12") or smaller diameter trees.
- Designed to gather bundle of stems and maximize grapple loads.

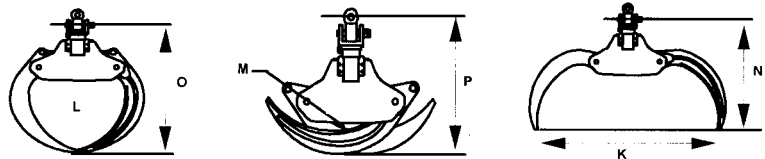

Grapples for 517		K	M	N	O	P	L
84" Sorting	mm	2130	76	1680	1980	1740	0.74 m ²
	in	84	3	66	78	68.5	8 ft ²
90" Sorting	mm	2290	102	1640	1920	1310	0.74 m ²
	in	90	4	64	75	51	8 ft ²
Grapples for 527		K	M	N	O	P	L
100" Sorting	mm	2540	76	1560	2040	1830	0.84 m ²
	in	100	3	61.5	80.5	72	9 ft ²
102" Bunching	mm	2590	76	1780	2020	136	0.93 m ²
	in	102	3	70	79.5	53.5	10 ft ²

Swing-boom

- Ability to reach and lift over the side to collect scattered logs.
- Has decking and loading capability.
- Excellent reach to the rear and side for maximum skidder versatility.

- Suitable for hard to reach timber on steep slopes, soft ground, or selection harvest and thinning.
- Reduces cycle times by reducing the amount of maneuvering of the skidder to reach logs.

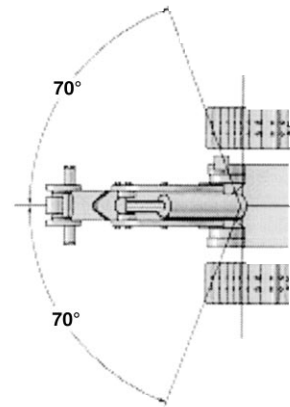
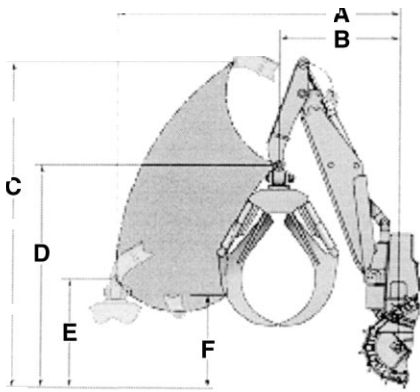

Swing-boom		A	B	C	D	E	F
517	mm	3269	1241	4092	2800	1366	1166
	in	129	49	161	110	54	46
527	mm	3544	1515	4048	2792	1358	1158
	in	139	60	160	110	53	46

Single-function arch

- Versatile attachment suitable for selection and clear cut applications.
- Reach consists of one vertical arc.
- Typical application includes short cycles and/or larger diameter timber.

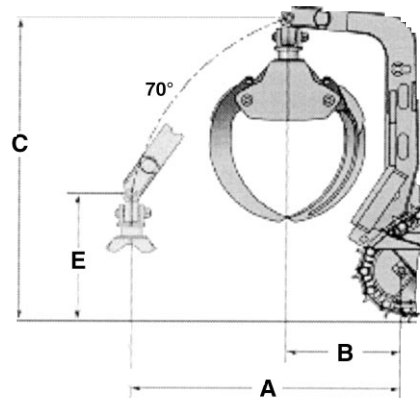

Single-function		A	B	C	D	E	F
517	mm	2465	909	2974	—	1000	—
	in	96	36	117	—	39	—
527	mm	2619	1105	2970	—	1231	—
	in	103	44	117	—	49	—

PIPELAYERS

CONTENTS

Features	7-1
Specifications	7-2
Lifting capacities	7-3
Drawbar Pull Charts	7-5
Travel and hook speeds	7-6

Features:

- **Planetary power shift** transmission on all models.
- **Kick-out helps prevent boom bending** as boom approaches near-vertical.
- **Sealed and Lubricated Track.**
- **Simplified Controls**, two levers control all functions including raise, lower, quick-drop and power down, high and low range and speed adjustments.
- **Modular design of major components and accessory drive system** for simplified repair.
- **Separate, self-energizing brakes** for boom and hook winches.
- **Positive track pin retention** (572R, 583R and 589).
- **Hydraulic Drawworks** with two independently driven hydraulic motors for boom and hook winches.
- **Suspended Undercarriage** for improved ride and greater operator comfort (583R and 589).



MODEL	561M		572R		583R		589		
Flywheel Power	82 kW	110 hp	171 kW	230 hp	228 kW	305 hp	313 kW	420 hp	
Operating Weight (with full fuel tank and operator)	16 240 kg	35,800 lb	30 110 kg	66,250 lb	44 750 kg	98,650 lb	65 366 kg	151,212 lb	
Engine Model	3116T		3306TA		3406C TA		3408TA		
Rated Engine RPM	2100		2100		2100		1900		
No. of Cylinders	6		6		6		8		
Displacement	6.6 L	403 in³	10.5 L	638 in³	14.6 L	893 in³	18 L	1099 in³	
Lift Capacity at 1.22 m (4'0") Overhang	18 145 kg	40,000 lb	40 910 kg	90,000 lb	63 500 kg	140,000 lb	104 330 kg	230,000 lb	
Standard Boom Length	5.49 m	18'0"	6.1 m	20'0"	6.1 m	20'0"	8.8 m	28'10"	
Width of Standard Shoe	510 mm	1'8"	660 mm	2'2"	710 mm	2'4"	914 mm	3'0"	
Length of Track on Ground	2.619 m	8'7"	3.167 m	10'5"	3.586 m	11'9"	4.29 m	14'1"	
Ground Contact Area (with standard shoes)	2.67 m ²	4120 in²	4.18 m ²	3250 in²	5.1 m ²	7896 in²	6.96 m ²	12,148 in²	
Track Gauge	2.0 m	6'7"	2.235 m	7'4"	2.34 m	7'8"	2.9 m	9'6"	
Fuel Tank Refill Capacity	218 L	57.6 U.S. gal	479 L	127 U.S. gal	416 L	110 U.S. gal	776 L	205 U.S. gal	
GENERAL DIMENSIONS:									
Height to Top of Stack	3.12 m	10'3"	3.45 m	11'4"	3.51 m	11'6"	3.92 m	12'10"	
Height to Top of Counterweight	1.68 m	5'6"	2.90 m	9'6"	3.41 m	11'2"	2.88 m	9'5"	
Width, Weights Retracted	3.19 m	10'5"	3.66 m	12'0"	3.63 m	11'11"	4.63 m	15'2"	
Minimum Shipping Width (both side frames removed)	2.90 m	9'6"	3.0 m	9'10"	3.48 m	11'5"	3.55 m	11'8"	
Shipping Width (left frame removed)	3.05 m	10'0"	3.66 m	12'0"	3.51 m*	11'6"*	—		
Overall Length	3.73 m	12'3"	4.74 m	15'6"	5.48 m	18'0"	5.94 m	19'6"	
Ground Clearance	438 mm	17.2"	414 mm	16.3"	537 mm	1'9.1"	625 mm	2'0.6"	
DRUMS and CABLES:									
Drum Capacity	Load	73 m	239'	80 m	263'	126 m	415'	152 m	500'
	Boom	49.4 m	162'	52 m	170'	126 m	415'	93 m	305'
Cable Diameter	Load	16 mm	0.62"	19 mm	0.75"	19 mm	0.75"	22 mm	0.88"
	Boom	16 mm	0.62"	19 mm	0.75"	19 mm	0.75"	22 mm	0.88"
Drum Diameter	Load	216 mm	8.5"	254 mm	10"	343 mm	13.5"	343 mm	13.5"
	Boom	245 mm	9.63"	224 mm	8.5"	343 mm	13.5"	343 mm	13.5"
Adjustable Counterweights		14 @ 177 kg ea	391 lb ea	9 @ 216 kg ea	475 lb ea	2 @ 299 kg ea	658 lb ea	7 @ 1315 kg ea	2900 lb ea
Total Weight Extendable						6 @ 535 kg ea	1180 lb ea		
						5 @ 432 kg ea	952 lb ea		
	3270 kg	7208 lb	4320 kg	9524 lb	9016 kg	19,880 lb	11 854 kg	26,134 lb	

*Boom and counterweight only removed.

561M

LIFTING CAPACITY* 5.49 m (18'0") BOOM

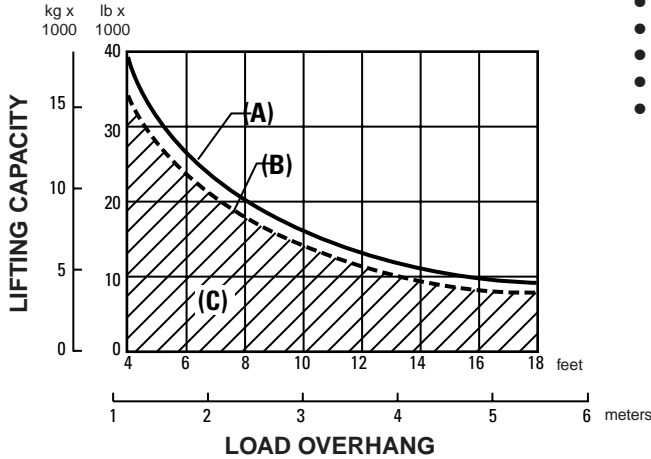

***Specified Equipment:**

- 16 mm (5/8") diameter wire rope.
- 18 688 kph (41,200 lb) minimum breaking strength.
- 3 part load line.
- 3 part boom line.
- 3270 kg (7208 lb) counterweight extended.
- Total operating weight 16 240 kg (35,804 lb).

KEY

- A — Max lift capacity per ANSI/SAE J743 MAR92
- B — Rated load capacity per ANSI/ASME B30.14
- C — Working range per ANSI/ASME B30.14

572R

LIFTING CAPACITY* 6.10 m (20'0") BOOM

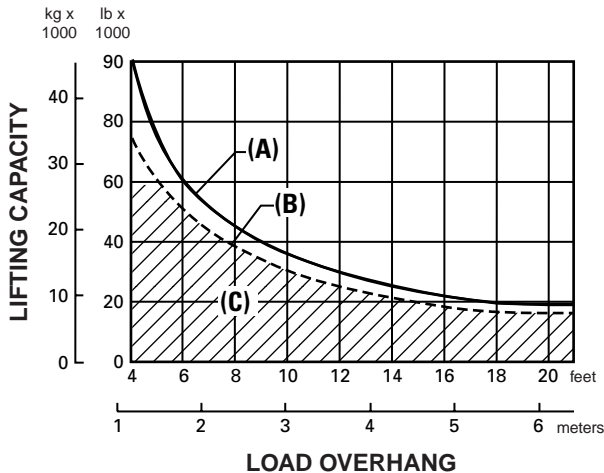

***Specified Equipment:**

- 19 mm (3/4") dia. wire rope 26 670 kg (58,800 lb) minimum breaking strength.
- 4 part load line.
- 4 part boom line.
- 4330 kg (9525 lb) of counterweights extended.
- 6.10 m (20'0") Boom.

KEY

- A — Max lift capacity per ANSI/SAE J743 MAR92
- B — Rated load capacity per ANSI/ASME B30.14
- C — Working range per ANSI/ASME B30.14

NOTE: SAE stands for the Society of Automotive Engineers. ANSI stands for American National Standard Institute.

583R

LIFTING CAPACITY* 6.10 m (20'0") BOOM

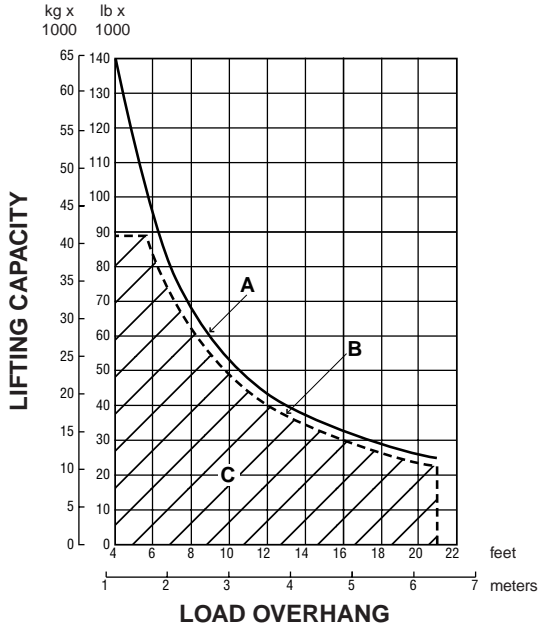

***Specified Equipment:**

- 19 mm (3/4") diameter wire rope.
- 26 672 kg (58,800 lb) minimum breaking strength.
- 6 part load line.
- 5 part boom line.
- 9036 kg (19,920 lb) counterweight extended.
- boom 6.10 m (20 ft) standard.
- total operating weight 44 748 kg (98,650 lb).

KEY

- A — Max lift capacity per SAE J743 MAR92
- B — Rated load capacity per ANSI/ASME B30.14
- C — Working range per ANSI/ASME B30.14

589

LIFTING CAPACITY* 8.53 m (28'0") BOOM

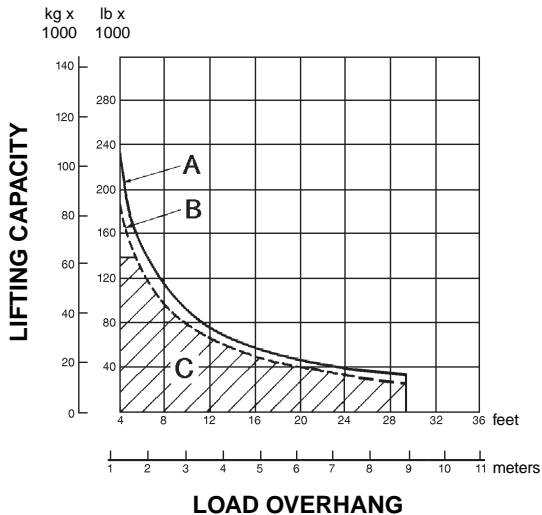

***Specified Equipment:**

- Load: 22 mm (7/8") dia. wire rope 31 389 kg (69,200 lb) minimum breaking strength.
- Boom: 22 mm (7/8") dia. wire rope 31 389 kg (69,200 lb) minimum breaking strength.
- 8 part load line.
- 8 part boom line.
- 14 633 kg (32,260 lb) of counterweights extended.
- 8.53 m (28'0") Boom.

KEY

- A — Max lift capacity per SAE J743b
- B — Max load capacity per ANSI B30.14
- C — Working range per ANSI B30.14

NOTE: SAE stands for the Society of Automotive Engineers. ANSI stands for American National Standard Institute.

561M

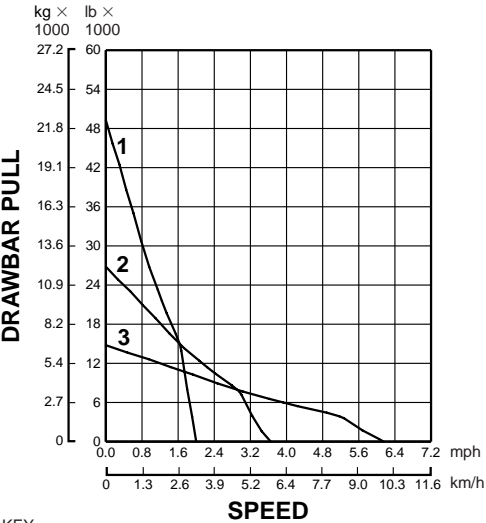

KEY

- 1 — 1st Gear
- 2 — 2nd Gear
- 3 — 3rd Gear

NOTE: Usable pull will depend upon weight and traction of equipped tractor.

572R

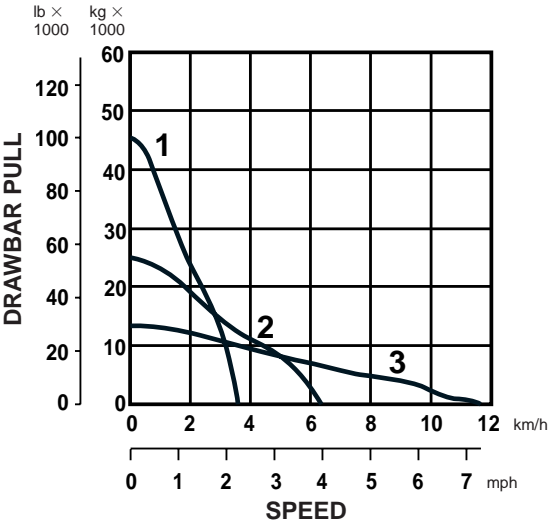

7

583R

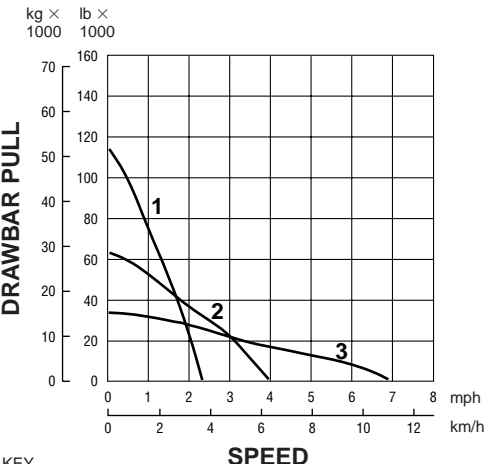

KEY

- 1 — 1st Gear
- 2 — 2nd Gear
- 3 — 3rd Gear

589

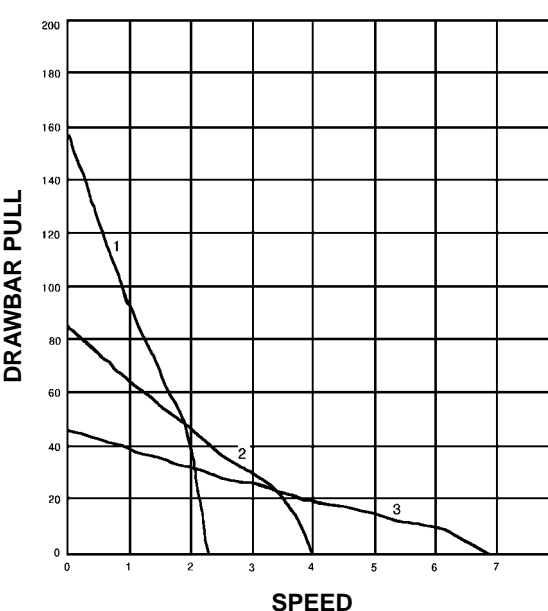

MODEL	561M				572R			
	Forward		Reverse		Forward		Reverse	
Travel Speeds (at rated RPM)	km/h	mph	km/h	mph	km/h	mph	km/h	mph
1st Gear	3.27	2.03	4.01	2.49	3.5	2.3	4.7	2.9
2nd Gear	5.81	3.61	7.09	4.41	6.4	4.0	8.1	5.0
3rd Gear	9.93	6.17	12.06	7.49	10.8	6.8	13.8	8.6

Pipelayer Hook Speeds per minute, Bare drum at rated engine RPM	m/min	ft/min	m/min	ft/min
First (Lo)	(33)	(108)	(11)	(37)
Second	—	—	—	—
Third (High)	(69.5)	(228)	(37)	(75)
Lower	—	—	16.3	53.4
Boom Line Speed	46	151	73	241

MODEL	583R				589			
	Forward		Reverse		Forward		Reverse	
Travel Speeds (at rated RPM)	km/h	mph	km/h	mph	km/h	mph	km/h	mph
1st Gear	3.5	2.3	4.7	2.9	3.5	2.2	4.3	2.7
2nd Gear	6.4	4.0	8.1	5.0	6.3	3.9	7.9	4.9
3rd Gear	10.8	6.8	13.8	8.6	10.9	6.8	13.7	8.5

Pipelayer Hook Speeds per minute, Bare drum at rated engine RPM	m/min	ft/min	m/min	ft/min
Low Raise	7.5	24	5.8	19
High Raise	22.0	73	17.4	57
Lower (Powered)	30.0	98	23.5	77

WHEEL TRACTOR-SCRAPERS

CONTENTS

Features	8-1
Specifications:	
Standard Scrapers	8-2
Tandem Powered and Push-Pull Scrapers ..	8-3
Elevating Scrapers	8-4
Auger Scrapers	8-5
Tire Options, all models	8-7
Use of Rimpull-Speed-Gradeability curves ..	8-8
Use of Travel Time charts	8-10
Fixed Times for Scrapers	8-11
Use of Retarder curves	8-11
Curves/charts:	
613C Series II Rimpull, Travel Times	8-13
615C Series II Rimpull, Travel Times	8-16
621F Rimpull, Retarding, Travel Times ..	8-19
623F Rimpull, Retarding, Travel Times ..	8-25
627F Rimpull, Retarding, Travel Times ..	8-29
631E Series II Rimpull, Retarding, Travel Times	8-35
633E Series II Rimpull, Retarding, Travel Times	8-41
637E Series II Rimpull, Retarding, Travel Times	8-45
651E Rimpull, Retarding, Travel Times ..	8-51
657E Rimpull, Retarding, Travel Times ..	8-55
Distance vs. Production Bm ³ (BCY)/hr, All models	8-61
Hourly Production vs. Cycle Time Bm ³ (BCY)/hr, All models	8-73

Features:

- **Hydraulic Electronic Unit Injector (HEUI)** fuel system used in 631E Series II thru 657E.
- **Semi-automatic power shift transmissions.** Eight speed used in 621F thru 657E.

- **Power shift transmissions** with six speeds used in 613C Series II and 615C Series II.
- **Differential lock ...** operator controlled, rigidly connects both tractor drive wheels for positive traction.
- **Cushion Hitch** on 621F through 657E (optional axle suspension on 615C Series II) absorbs haul road shocks, stabilizes machine travel, substantially increases usable working speeds.
- **Double-acting hydraulics** supply positive cutting edge penetration, apron closure and material ejection. Positive bulldozer-type ejection. Automatic ejector return kickout.
- **Quick-drop valves** for pump loading (except 613C Series II, 615C Series II, 623F, 633E). Carry check valves isolate bowl cylinders to carry load rather than hydraulic lines.
- **Hydraulic retarder** standard on 651E/657E, optional on 621F through 637E Series II. Not available on 613C Series II or 615C Series II.

Tandem Powered:

- **Push-Pull arrangement** allows two 627F, 637E Series II or 657E scrapers to assist one another in loading eliminating the push tractor.

Elevating:

- **Uninterrupted elevator reverse** allows sticky material to be ejected more easily.
- **Two-speed elevator** on 613C Series II and 615C Series II allows operator to match elevator speed to material conditions.
- **Infinitely variable elevator speed** on 623F and 633E allows operator to match elevator speed to material conditions.

Auger:

- **Factory installed attachment** provides self loading capability in standard and tandem powered scrapers.

Wheel Tractor-Scrapers

Specifications

- Standard Scrapers



MODEL	621F		631E Series II		651E	
Flywheel Power	246 kW	330 hp	335/365 kW	450/490 hp	410/452 kW	550/605 hp
Approx. Operating Weight (Empty) ◀	32 070 kg	70,700 lb	45 400 kg	100,000 lb	61 120 kg	134,760 lb
Scraper Capacity —						
Struck	10.7 m ³	14 yd³	16.1 m ³	21 yd³	24.5 m ³	32 yd³
Heaped	15.3 m ³	20 yd³	23.7 m ³	31 yd³	33.6 m ³	44 yd³
Rated Load	21 775 kg	48,000 lb	34 020 kg	75,000 lb	47 175 kg	104,000 lb
Weight Distribution — Empty						
Drive		68%		67%		66%
Rear		32%		33%		34%
Weight Distribution — Loaded						
Drive		53%		53%		53%
Rear		47%		47%		47%
Engine Model		3406C		3408		3412
Rated Engine RPM		1900		2000		1900
Displacement	14.6 L	893 in³	18 L	1099 in³	27 L	1649 in³
Top Speed (Loaded)	51 km/h	32 mph	53 km/h	33 mph	53 km/h	33 mph
Non-Stop Turning Circle	10.9 m	35'8"	12.2 m	40'1"	13.6 m	44'7"
With ROPS Restriction		—		—		47'7"
Tires — Tractor Drive		33.25R29**E2/E3		37.25R35**E2/E3		40.5/75R39
Scraper		33.25R29**E2/E3		37.25R35**E2/E3		40.5/75R39
Width of Cut	3.02 m	9'11"	3.49 m	11'6"	3.85 m	12'8"
Maximum Depth of Cut	333 mm	13.1"	437 mm	17.2"	470 mm	18.5"
Maximum Depth of Spread	522 mm	1'8.6"	480 mm	18.9"	533 mm	1'9"
Fuel Tank Refill Capacity	530 L	140 U.S. gal	806 L	213 U.S. gal	954 L	252 U.S. gal
GENERAL DIMENSIONS:						
Height to Top of Scraper	3.71 m	12'2"	4.29 m	14'1"	4.71 m	15'5"
Wheelbase	7.72 m	25'4"	8.77 m	28'9"	9.97 m	32'9"
Overall Length	12.93 m	42'5"	14.56 m	47'9"	16.18 m	53'1"
Overall Width	3.47 m	11'4"	3.94 m	12'11"	4.35 m	14'4"
Shipping Width (Draft Arm on Inside of Bowl)		—	3.64 m	11'11"	3.91 m	12'10"
Scraper Tread	2.18 m	7'2"	2.46 m	8'1"	2.81 m	9'3"
Tractor Tread	2.20 m	7'3"	2.46 m	8'1"	2.64 m	8'8"

◀ Operating weight includes standard machine, coolant, lubricants, full fuel tank, and operator.

- Specifications
- Tandem Powered
- Push-Pull

Wheel Tractor-Scrapers



MODEL	627F		637E Series II		657E	
Flywheel Power: Tractor	246.2 kW	330 hp	335/365 kW	450/490 hp	410/452 kW	550/605 hp
Scraper	168 kW	225 hp	187 kW	250 hp	298/328 kW	400/440 hp
Approx. Operating Weight (Empty)◀	37 060 kg	81,640 lb	50 990 kg	112,320 lb	70 670 kg	155,650 lb
Scraper Capacity: Struck	10.7 m ³	14 yd³	16.1 m ³	21 yd³	24.5 m ³	32 yd³
Heaped	15.3 m ³	20 yd³	23.7 m ³	31 yd³	33.6 m ³	44 yd³
Rated Load	21 775 kg	48,000 lb	34 020 kg	75,000 lb	47 175 kg	104,000 lb
Weight Distribution — Empty: Front		60%		59%		60%
Rear		40%		41%		40%
Weight Distribution — Loaded: Front		49%		49%		51%
Rear		51%		51%		49%
Engine Model: Tractor		3406C		3408		3412
Scraper		3306		3306		3408
Rated Engine RPM: Tractor		1900		2000		1900
Scraper		2200		2200		1900
Displacement: Tractor	14.6 L	893 in³	18 L	1099 in³	27 L	1649 in³
Scraper	10.5 L	638 in³	10.5 L	638 in³	18 L	1099 in³
Top Speed (Loaded)	51.3 km/h	32 mph	53 km/h	33 mph	53 km/h	33 mph
Non-Stop Turning Circle	10.9 m	35'9"	12.2 m	40'1"	13.6 m	44'8"
With ROPS Restriction		—		—	14.5 m	47'7"
Tires — Tractor Drive		33.25R29**E2/E3		37.25R35**E2/E3		40.5/75R39
Scraper		33.25R29**E2/E3		37.25R35**E2/E3		40.5/75R39
Width of Cut	3.02 m	9'11"	3.51 m	11'6"	3.85 m	12'8"
Maximum Depth of Cut	333 mm	13.1"	437 mm	17"	470 mm	18.5"
Maximum Depth of Spread	522 mm	1'8.6"	480 mm	18.9"	533 mm	1'9"
Fuel Tank Refill Capacity: Tractor		—		—		—
Scraper	992 L	262 U.S. gal	1272 L	336 U.S. gal	1772 L	468 U.S. gal
GENERAL DIMENSIONS:						
Height to Top of Scraper	3.81 m	12'2"	4.29 m	14'1"	4.71 m	15'5"
Wheelbase	7.72 m	25'4"	8.77 m	28'9"	9.97 m	32'9"
Overall Length	12.93 m	42'5"	14.56 m	47'9"	16.2 m	53'0"
Overall Width	3.47 m	11'4"	3.94 m	12'11"	4.35 m	14'4"
Shipping Width (Draft Arm on Inside of Bowl)		—	3.64 m	11'11"	3.91 m	12'10"
Scraper Tread	2.18 m	7'2"	2.46 m	8'1"	2.81 m	9'3"
Tractor Tread	2.21 m	7'3"	2.46 m	8'1"	2.64 m	8'8"
PUSH-PULL GENERAL DIMENSIONS:						
Operating Weight (Empty)◀	38 103 kg	84,000 lb	52 385 kg	115,490 lb	72 640 kg	160,140 lb
Overall Length	15.2 m	49'7"	16.49 m	54'1"	18.01 m	59'1"
Weight Distribution — Empty: Front		60%		60%		60%
Rear		40%		40%		40%
Weight Distribution — Loaded: Front		49%		50%		51%
Rear		51%		50%		49%

◀ Operating weight includes standard machine, coolant, lubricants, full fuel tank, and operator.

Wheel Tractor-Scrapers

Specifications ● Elevating Scrapers



MODEL	613C Series II		615C Series II		623F		633E Series II	
Flywheel Power	131 kW	175 hp	197.5 kW	265 hp	272 kW	365 hp	335/365 kW* 450/490 hp*	
Approx. Operating Weight (Empty)◀	15 264 kg	33,650 lb	25 605 kg	56,450 lb	35 290 kg	77,800 lb	51 110 kg	112,670 lb
Scraper Capacity — Heaped	8.4 m ³	11 yd³	13 m ³	17 yd³	17.6 m ³	23 yd³	26 m ³	34 yd³
Rated Load	11 975 kg	26,400 lb	18 506 kg	40,800 lb	24 950 kg	55,000 lb	37 200 kg	82,000 lb
Weight Distribution — Empty								
Drive		63%		66%		65%		64%
Rear		37%		34%		35%		36%
Weight Distribution — Loaded								
Drive		49%		51%		52%		51%
Rear		51%		49%		48%		49%
Engine Model		3116		3306		3406C		3408
Rated Engine RPM		2300		2200		1900		2000
Displacement	6.6 L	403 in³	10.5 L	638 in³	14.6 L	893 in³	18 L	1099 in³
Top Speed (Loaded)	35.1 km/h	21.8 mph	44.4 km/h	27.6 mph	48 km/h	30 mph	53 km/h	32.9 mph
Non-Stop Turning Circle	8.9 m	29'4"	9.63 m	31'7"	10.9 m	35'8"	13.16 m	43'2"
Tires — Standard								
Tractor		23.5R25*		29.5R25*		33.25R29**E2		37.25R35**E2
Scraper		23.5R25*		29.5R25*		33.25R29**E2		37.25R35**E2
Width of Cut	2.35 m	7'8.5"	2.89 m	9'6"	3.5 m	11'6"	3.5 m	11'6"
Maximum Depth of Cut	160 mm	6.3"	414 mm	16.3"	330 mm	13"	431 mm	17"
Elevator Flight Spacing	419 mm	16.5"	419 mm	16.5"	520 mm	1'8.5"	610 mm	2'0"
Number of Flights		15		18		15		14
Maximum Floor Opening	1.14 m	3'9"	1.181 m	3'10.5"	1.53 m	5'	1.22 m	4'0"
Maximum Depth of Spread	370 mm	14.6"	399 mm	15.7"	390 mm	15.4"	578 mm	1'10.7"
Fuel Tank Refill Capacity	250 L	66 U.S. gal	399 L	105 U.S. gal	606 L	160 U.S. gal	807 L	213 U.S. gal
GENERAL DIMENSIONS:								
Height to Top of Scraper	3.06 m	10'0"	3.589 m	11'9"	3.58 m	11'9"	4.24 m	13'11"
Wheelbase	6.26 m	20'6.5"	6.995 m	22'11"	7.98 m	26'2"	9.02 m	29'7"
Overall Length	10 m	32'9"	11.6 m	38'1"	13.21 m	43'4"	14.81 m	48'7"
Overall Width	2.44 m	8'0"	3.05 m	10'0"	3.55 m	11'8"	3.96 m	13'0"
Shipping Width (Draft Arm on Inside of Bowl)	2.44 m	8'0"	3.05 m	10'0"	3.55 m	11'8"	3.64 m	11'11"
Scraper Tread	1.80 m	5'11"	2.12 m	6'9"	2.20 m	7'3"	2.5 m	8'1"
Tractor Tread	1.80 m	5'11"	2.12 m	6'9"	2.20 m	7'3"	2.5 m	8'1"

◀ Operating weight includes coolants, lubricants, ROPS canopy, full fuel tank and operator.

* Elevator on.



MODEL	621F		631E Series II		651E	
Flywheel Power: Tractor	272 kW	365 hp	335/365 kW	450/490 hp	410/452 kW	550/605 hp
Approx. Operating Weight (Empty)◀	37 762 kg	83,250 lb	45 980 kg	101,370 lb	66 575 kg	146,770 lb
Scraper Capacity (Heaped)	15.96 m ³	21 yd ³	23.7 m ³	31 yd ³	33.6 m ³	44 yd ³
Rated Load	21 775 kg	48,000 lb	34 020 kg	75,000 lb	47 175 kg	104,000 lb
Approx. Operating Weight (Loaded)	57 950 kg	127,750 lb	80 000 kg	176,370 lb	113 750 kg	250,770 lb
AUGER ATTACHMENT						
Auger Diameter	1320 mm	4'4"	1524 mm	5'0"	1676 mm	5'6"
Auger RPM	Variable 55 to 35 RPM		Variable 55 to 35 RPM		Variable 55 to 35 RPM	
Auger Power	149 kW	200 hp	201 kW	270 hp	354 kW	475 hp
Hydraulic Flow	273 L/min	72 gpm	378 L/min	100 gpm	549 L/min	145 gpm
Cooling Flow	—	—	—	—	132 L/min	35 gpm
System Pressure	41 370 kPa	6000 psi	37 895 kPa	5500 psi	41 370 kPa	5700 psi
Auger Control	electronic		electronic		electronic	

◀Operating weight includes standard machine, coolant, lubricants, full fuel tank and operator.

The auger scraper is a self-loading system that offers an alternative to conventional, push-pull or elevating scrapers. An independent hydrostatic system powers the auger which is located near the center of the bowl. The rotating auger lifts and evenly distributes over 50% of the material that flows over the scraper cutting edge. This action reduces the cutting edge resistance allowing the wheel tractor-scraper to continue moving through the cut and quickly obtain full rated loads.

Advantages:

- Self-load in equal or less time
- Requires shorter cut distance
- Complete material ejection (angled ejector pushes material)
- Significantly reduces dust problems in dry material
- Increased tire life
- Broader material appetite
- Better material retention on haul road (closed apron instead of open elevator)

● Tandem Powered Auger



MODEL	627F		637E Series II		657E	
Flywheel Power: Tractor	246 kW	330 hp	335/365 kW	450/490 hp	410/452 kW	550/605 hp
Scraper	168 kW	225 hp	187 kW	250 hp	298 kW	400 hp
Approx. Operating Weight (Empty)◀	42 230 kg	93,100 lb	54 540 kg	120,235 lb	75 875 kg	167,270 lb
Scraper Capacity (Heaped)	15.96 m ³	21 yd³	23.7 m ³	31 yd³	33.6 m ³	44 yd³
Rated Load	21 775 kg	48,000 lb	34 020 kg	75,000 lb	47 175 kg	104,000 lb
Approx. Operating Weight (Loaded)	62 160 kg	137,035 lb	88 560 kg	195,235 lb	123 050 kg	271,270 lb
AUGER ATTACHMENT						
Auger Diameter	1320 mm	4'4"	1524 mm	5'0"	1676 mm	5'6"
Auger RPM	Variable 55 to 35 RPM		Variable 55 to 35 RPM		Variable 55 to 35 RPM	
Auger Power	149 kW	200 hp	201 kW	270 hp	354 kW	475 hp
Hydraulic Flow	273 L/min	72 gpm	378 L/min	100 gpm	549 L/min	145 gpm
Cooling Flow	—	—	—	—	132 L/min	35 gpm
System Pressure	41 370 kPa	6000 psi	37 923 kPa	5500 psi	41 340 kPa	5700 psi
Auger Control	electronic		electronic		electronic	

◀ Operating weight includes standard machine, coolant, lubricants, full fuel tank and operator.

The auger scraper is a self-loading system that offers an alternative to conventional, push-pull or elevating scrapers. An independent hydrostatic system powers the auger which is located near the center of the bowl. The rotating auger lifts and evenly distributes over 50% of the material that flows over the scraper cutting edge. This action reduces the cutting edge resistance allowing the wheel tractor-scraper to continue moving through the cut and quickly obtain full rated loads.

Advantages:

- Self-load in equal or less time
- Requires shorter cut distance
- Complete material ejection (angled ejector pushes material)
- Significantly reduces dust problems in dry material
- Increased tire life
- Broader material appetite
- Better material retention on haul road (closed apron instead of open elevator)

TIRE OPTIONS			613C Series II		615C Series II		621F 623F 627F		631E Series II 633E Series II 637E Series II		651E 657E	
			Tr.	Sc.	Tr.	Sc.	Tr.	Sc.	Tr.	Sc.	Tr.	Sc.
23.5-25	20 PR	E2	●	●								
"	"	E3	●	●								
23.5R25	★		●	1 ●								
26.5R25	★★	E2			●	●						
29.5-25	28 PR	E2			●	●						
"	"	E3			●	●						
29.5R25	★	E2			●	2 ●						
29.5-25	34 PR	E3			●	●						
29.5-29	34 PR	E2					●	●				
"	"	E3					●	●				
29.5R29	★★	E2					●	●				
"	"	E3					●	●				
33.25-29	32 PR	E3					●	●				
33.25R29	★★	E2					●	3 ●				
"	"	E3					●	●				
37.25-35	42 PR	E3							●	●		
37.25R35	★★	E2/E3							●	4 & 5 ●		
37.5-39	52 PR	E3									●	●
37.5R39	★★	E3									●	●
40.5/75R39	★★	E3									●	6 ●

KEY

1. Standard on 613C Series II.
2. Standard on 615C Series II.
3. Standard on 621F, 623F and 627F.
4. Standard on 631E Series II and 637E Series II.
5. Standard on 633E Series II.
6. Standard on 651E and 657E.

USE OF RIMPULL-SPEED-GRADEABILITY CURVES

The following explanation applies to Rimpull-Speed-Gradeability curves for Wheel Tractor-Scrapers, Construction & Mining Trucks/Tractors and Articulated Trucks.

Maximum speed attainable, gear range and available rimpull can be determined from curves on the following pages when machine weight and total effective grade (or total resistance) are known.

Rimpull is the force (in kg, lb or kN) available between the tire and the ground to propel the machine (limited by traction).

Weight is defined as Gross Machine Weight (kg or lb) = Machine + Payload.

Total Effective Grade (or Total Resistance) is grade resistance plus rolling resistance expressed as percent grade.

Grade is measured or estimated.

Rolling resistance is estimated (see Tables section for typical values.)

10 kg/metric ton (20 lb/U.S. ton) = 1% adverse grade.

Example

With a 6% grade and a rolling resistance of 40 kg/metric ton (80 lb/U.S. ton), find total resistance.

Rolling resistance = $40 \text{ kg/t} \div 10 = 4\%$ Effective Grade

(English: $80 \text{ lb} \div 20 = 4\%$)

Total resistance = 4% rolling + 6% grade = 10%

Altitude Derating

Rimpull force and speed must be derated for altitude similar to flywheel horsepower. The percentage loss in rimpull force approximately corresponds to the percentage loss in flywheel horsepower. See Tables Section for altitude derations.

Rimpull-Speed-Gradeability

To determine gradeability performance: Read from gross weight down to the % of total resistance. (Total resistance equals actual % grade *plus* 1% for each 10 kg/metric ton (20 lb./U.S. ton) of rolling resistance.) From this weight-resistance point, read horizontally to the curve with the highest obtainable speed range, then down to the maximum speed. Usable rimpull depends upon traction and weight on drive wheels.

Example problem:

A 631E Series II with an estimated payload of 34 020 kg (75,000 lb) is operating on a total effective grade of 10%. Find the available rimpull and maximum attainable speed.

Empty weight payload = Gross Weight
 $43\,945 \text{ kg} + 34\,020 \text{ kg} = 77\,965 \text{ kg}$
 $(96,880 \text{ lb} + 75,000 \text{ lb} = 171,880 \text{ lb})$

Solution: Using graph on the next page, read from 77 965 kg (171,880 lb) (point A) on top of gross weight scale down the line to the intersection of the 10% total resistance line (point B).

Go across horizontally from B to the Rimpull Scale on the left (point D). This gives the required rimpull: 7756 kg (17,100 lb).

Where the line cuts the speed curve (point C), read down vertically (point E) to obtain the maximum speed attainable for the 10% effective grade: 12.9 km/h (8 mph).

ANSWER: The machine will climb the 10% effective grade at a maximum speed of 12.9 km/h (8 mph) in 4th gear. Available rimpull is 7756 kg (17,100 lb).



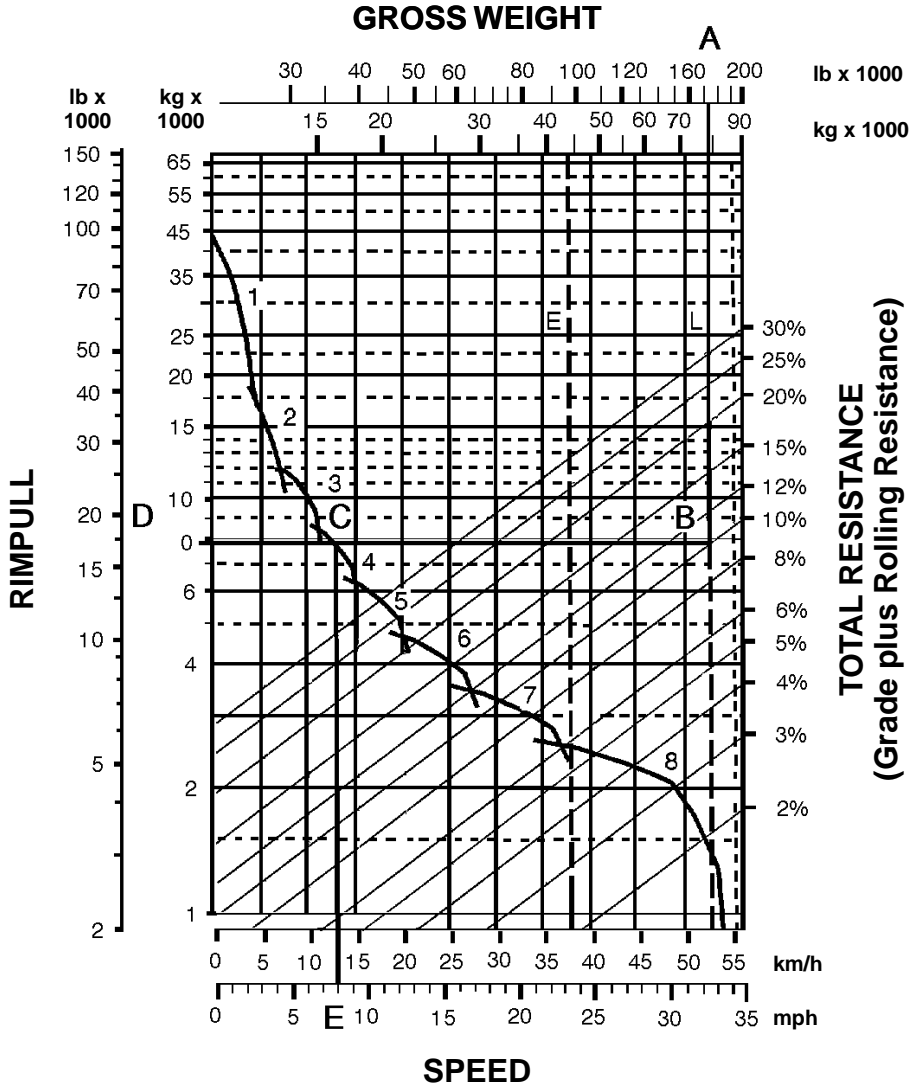

KEY

- 1 — 1st Gear Torque Converter Drive
- 2 — 2nd Gear Torque Converter Drive
- 3 — 3rd Gear Direct Drive
- 4 — 4th Gear Direct Drive
- 5 — 5th Gear Direct Drive
- 6 — 6th Gear Direct Drive
- 7 — 7th Gear Direct Drive
- 8 — 8th Gear Direct Drive

KEY

- A — Loaded 77 965 kg (171,880 lb)
- B — Intersection with 10% total resistance line
- C — Intersection with rimpull curve (4th gear)
- D — Required rimpull 7756 kg (17,100 lb)
- E — Speed 12.9 km/h (8 mph)

USE OF TRAVEL TIME CHARTS

The following explanation applies to travel time charts for Wheel Tractor-Scrapers, Construction & Mining Trucks and Articulated Trucks.

One-way travel time can be determined from graphs on the following pages when one-way travel distance and total resistance (expressed in percent) are known. 10 kg/metric ton (20 lb/U.S. ton) equals 1% equivalent grade.

If total resistance is negative (grade assistance greater than rolling resistance) machine may accelerate downhill requiring the use of retarder or brakes. Travel time charts cannot be used in these cases. Consult respective machine retarder curve to establish maximum safe downhill speed.

Two graphs are given for each hauling unit: one for the machine carrying its rated payload and one for the empty machine.

Travel times were derived using Caterpillar Machine Simulation Program and standard tire inputs. Travel times for machines equipped with (larger) optional tires vary slightly.

Example problem:

631E Series II hauls its rated payload 34 020 kg — 19.1 bank cubic meters (75,000 lb — 25 bank cubic yards) on a 4% road for 610 m (2000 feet) and returns on a 0% road for 760 m (2500 feet). Find the cycle time.

Haul —

Using the graph for the Loaded machine, read from the Travel Distance (one way) scale at 610 m (2000 feet) across to the 4% total resistance line (point A). From (point A) read down to the Travel Time (one way) scale to determine haul time = 1.4 minutes.

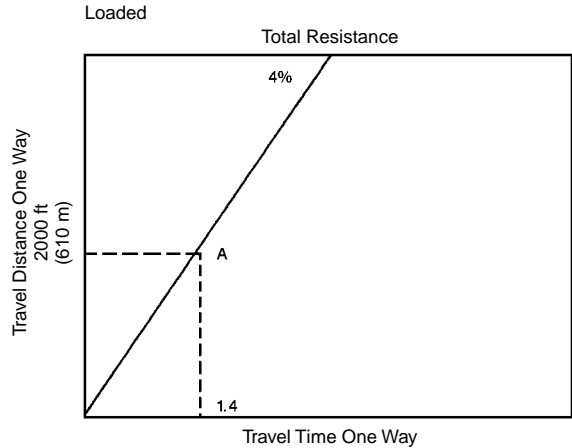

Return —

Using the graph for the Empty machine, read from the Travel Distance (one way) scale at 760 m (2500 feet) across to the 0% total resistance line (point A). From (point A) read down to the Travel Time (one way) scale to determine return time = 1 min.

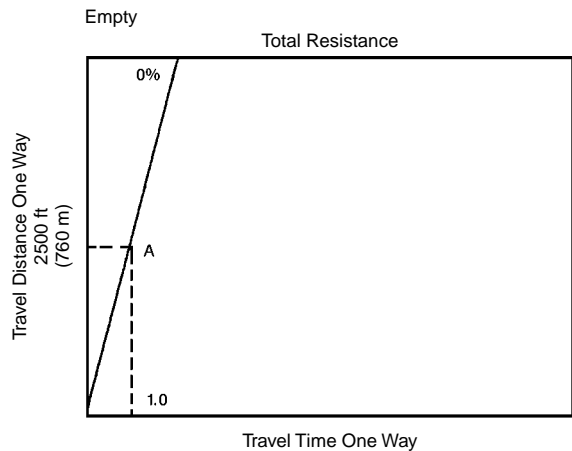

Cycle Time —

$$= \text{load}^* + \text{haul} + \text{maneuver \& spread}^* + \text{return}$$

$$= 0.6 + 1.4 + 0.7 + 1.0$$

$$= 3.7 \text{ min.}$$

*For fixed time (load, maneuver and spread) see the table below.

When cycle time and payload are known, productivity can be calculated. For a more complex example see the Earthmoving Section.



TYPICAL FIXED TIMES FOR SCRAPERS
(Times may vary depending on job conditions)

Model	Loaded By	Load Time (Min.)	Maneuver and Spread or Maneuver and Dump (Min.)
613C Series II	Self	0.9	0.7
615C Series II	Self	0.9	0.7
623F	Self	0.9	0.7
633E Series II	Self	0.9	0.7
621F	One D8R	0.5	0.7
627F	One D8R	0.5	0.6
621F	One D9R	0.4	0.7
627F	One D9R	0.4	0.6
627F PP	Self	0.9*	0.6
631E Series II	One D9R	0.6	0.7
637E Series II	One D9R	0.6	0.6
631E Series II	One D10R	0.5	0.7
637E Series II	One D10R	0.5	0.6
637E/PP Series II	Self	1.0*	0.6
651E	One D11R	0.6	0.7
657E	One D11R	0.6	0.6
657E	Push Pull	1.1*	0.6
	Self		
621F	Auger	0.9	0.7
627F	Auger	0.7	0.7
631E Series II	Auger	0.9	0.7
637E Series II	Auger	0.8	0.7
651E	Auger	1.3	0.7
657E	Auger	1.0	0.7

*Load time per pair, including transfer time.

NOTE: Empty Weights shown on the Wheel Tractor-Scraper charts includes ROPS Canopy. The travel times will remain within acceptable limits when applied to a non-ROPS equipped machine. When calculating TMPH loadings any additional weight must be considered in establishing mean tire loads.

USE OF RETARDER CURVES

The following explanation applies to retarder curves for Wheel Tractor-Scrapers and Articulated Trucks.

The speed that can be maintained (without use of service brake) when the machine is descending a grade with retarder fully on can be determined from the retarder curves in this section if gross machine weight and total effective grade are known.

Total Effective Grade (or Total Resistance) is grade assistance *minus* rolling resistance.

10 kg/metric ton (20 lb/U.S. ton) = 1% adverse grade.

Example

15% favorable grade with 5% rolling resistance. Find Total Effective Grade.

$$\text{Total Effective Grade} = 15\% \text{ Grade Assistance} - 5\%$$

$$\text{Rolling Resistance} = 10\% \text{ Total Effective Grade Assistance.}$$

Example problem:

A 651E with an estimated payload of 47 175 kg (104,000 lb) descends a 10% total effective grade. Find constant speed and gear range with maximum retarder effort. Find travel time if the slope is 610 m (2000 ft) long.

$$\begin{aligned} \text{Empty Weight} + \text{Payload} &= \text{Gross Weight} \\ &= 60\,950 \text{ kg} + 47\,175 \text{ kg} = 108\,125 \text{ kg} \\ &= (134,370 \text{ lb} + 104,000 \text{ lb} = 238,370 \text{ lb}) \end{aligned}$$

Solution: Using the retarder curve below, read from 108 125 kg (238,370 lb) (point A) on top of gross weight scale down the line to the intersection of the 10% effective grade line (point B).

Go across horizontally from point B to the intersection of the retarder curve (point C). Point C intersects at the 5 (5th gear) range.

Where point C intersects the retarder curve, read down vertically to point D on the bottom scale to obtain the constant speed: 21.7 km/h (13.5 mph).

ANSWER: The 651E will descend the slope at 21.7 km/h (13.5 mph) in 5th gear. Travel time is 1.68 minutes.

$$\frac{610 \text{ m}}{363 \text{ m/min}} = 1.68 \text{ min}$$

*(mph × 88 = F.P.M.)

$$\frac{2000 \text{ ft}}{13.5 \text{ mph} \times 88^*} = 1.68 \text{ min}$$

NOTE: The basic Distance-Speed-Time formula is $60 D \div S = T$ (or "60 D Street"), where 60 is minutes, D is distance, S is speed and T is time. In the above problem, $60 \times 610 \text{ m} \div 21.7 \text{ km/h} \times 1000 = T$.

$$\frac{60 \times 610}{21.7 \times 1000} = T = (1.68)$$

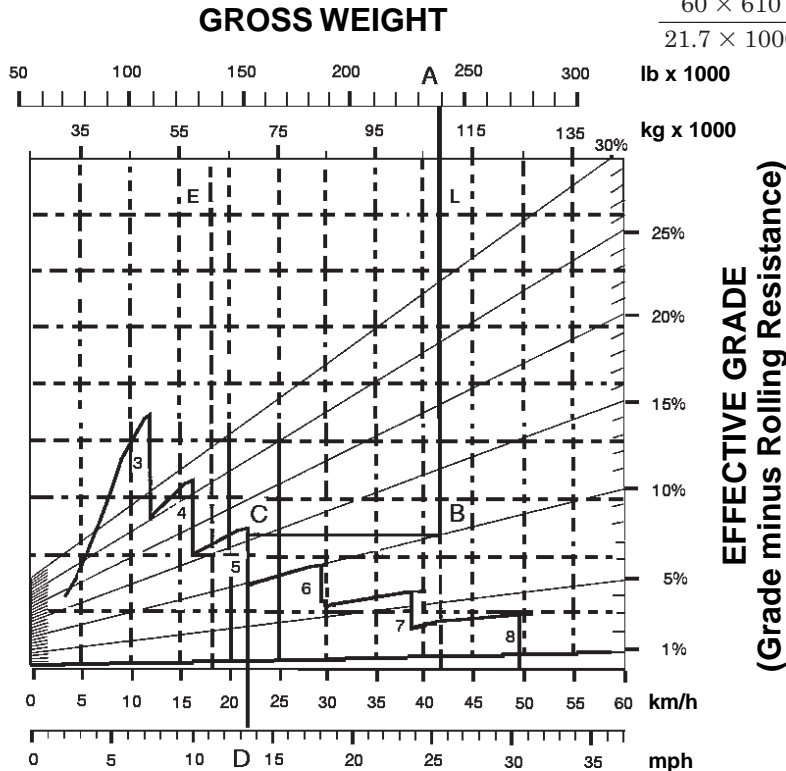

KEY

- 3 — 3rd Gear Direct Drive
- 4 — 4th Gear Direct Drive
- 5 — 5th Gear Direct Drive
- 6 — 6th Gear Direct Drive
- 7 — 7th Gear Direct Drive
- 8 — 8th Gear Direct Drive

KEY

- A — Loaded 108 125 kg (238,370 lb)
- B — Intersection with 10% effective grade line
- C — Intersection with retarder curve (5th gear)
- D — Constant speed 21.7 km/h (13.5 mph)

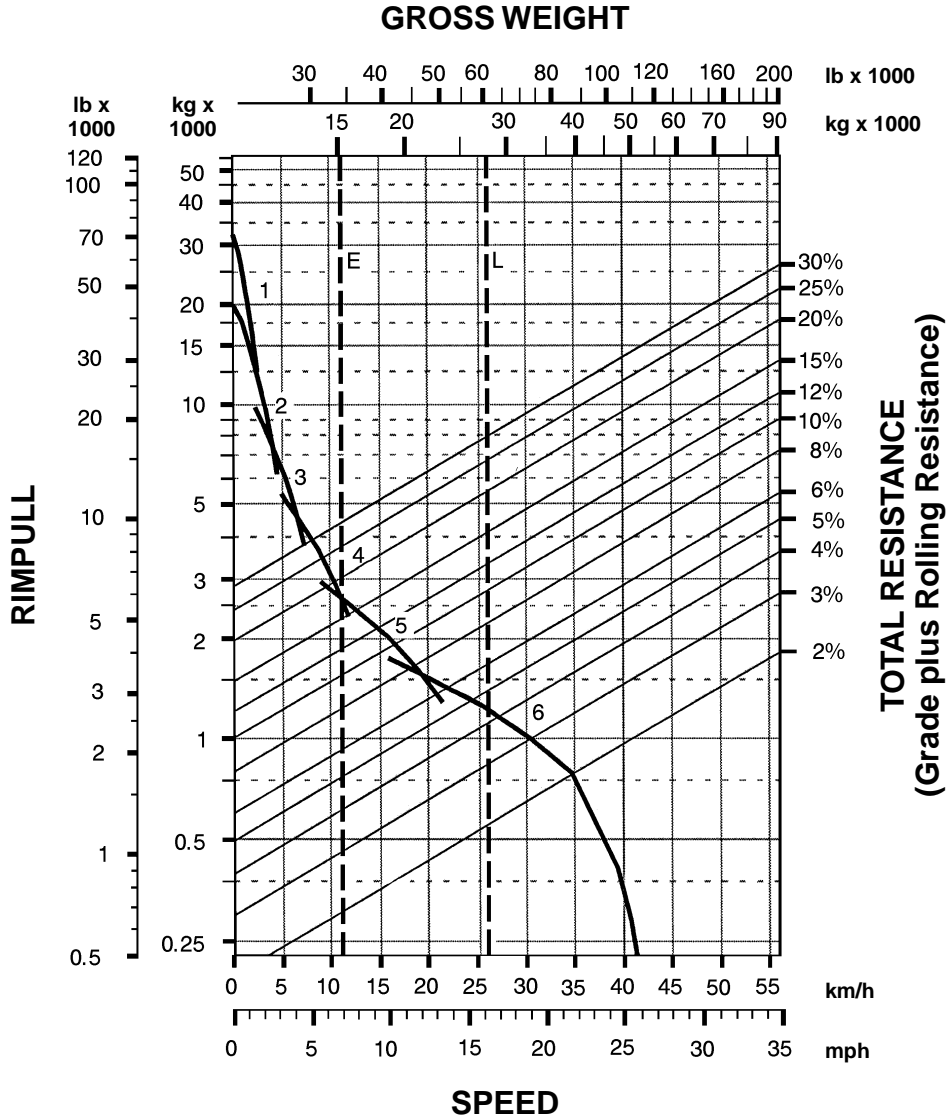

KEY

- 1 — 1st Torque Converter Drive
- 2 — 2nd Torque Converter Drive
- 3 — 3rd Torque Converter Drive
- 4 — 4th Torque Converter Drive
- 5 — 5th Torque Converter Drive
- 6 — 6th Torque Converter Drive

KEY

- E — Empty 15 265 kg (33,650 lb)
- L — Loaded 27 240 kg (60,050 lb)

LOADED

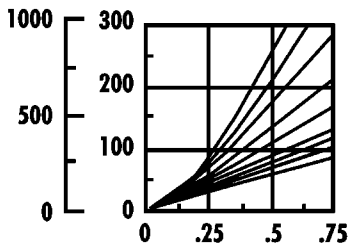
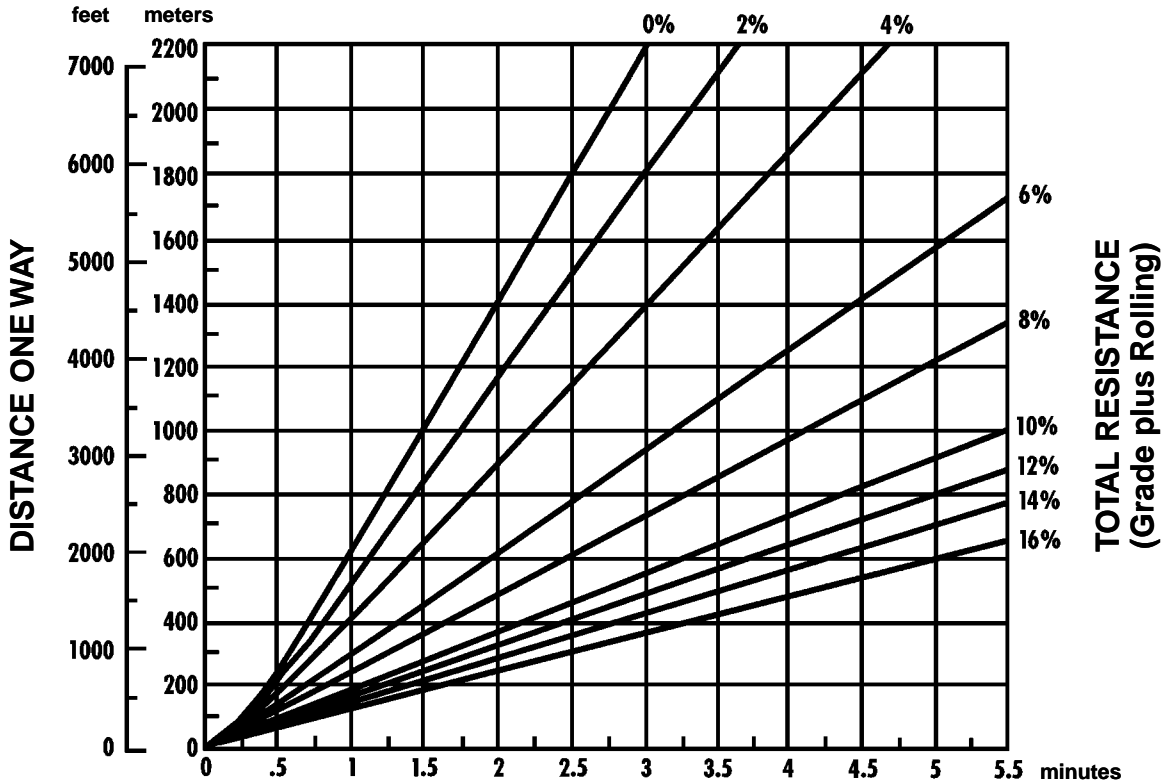

TIME

Empty weight: 15 264 kg (33,650 lb)
 Payload: 11 975 kg (26,400 lb)

EMPTY

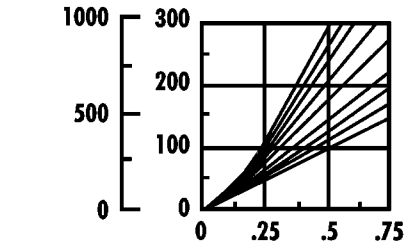
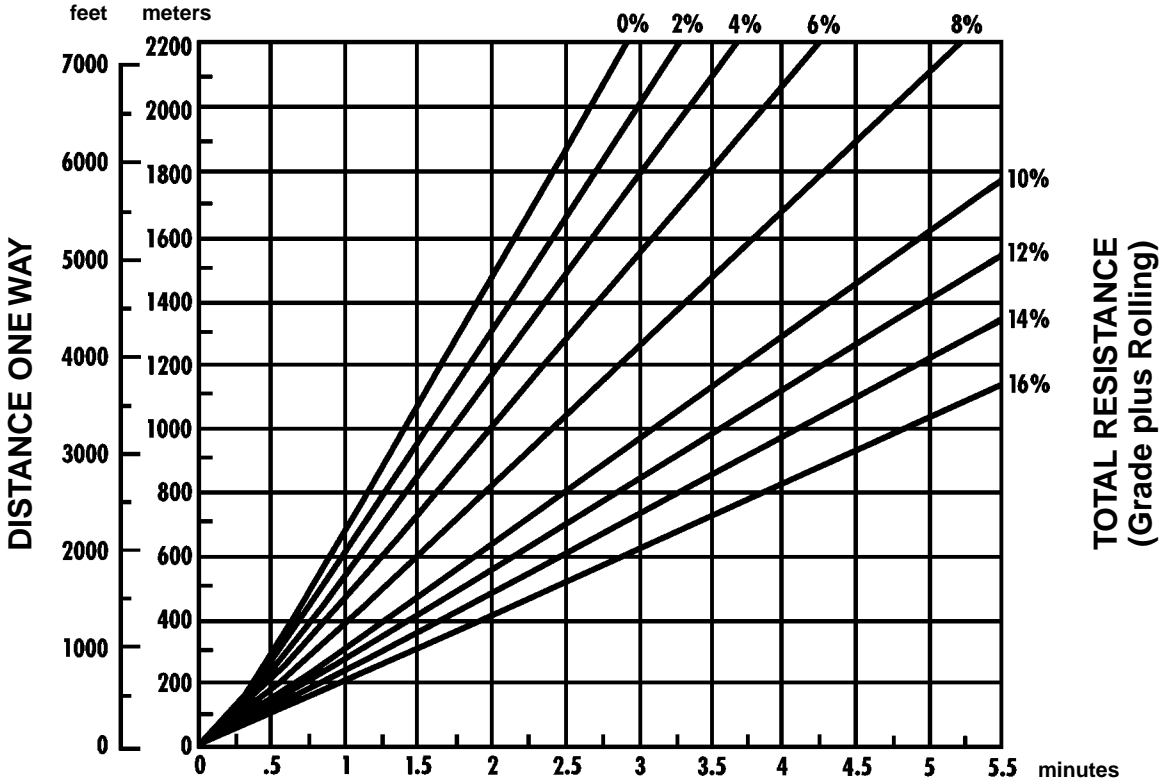

Empty weight: 15 264 kg (33,650 lb)

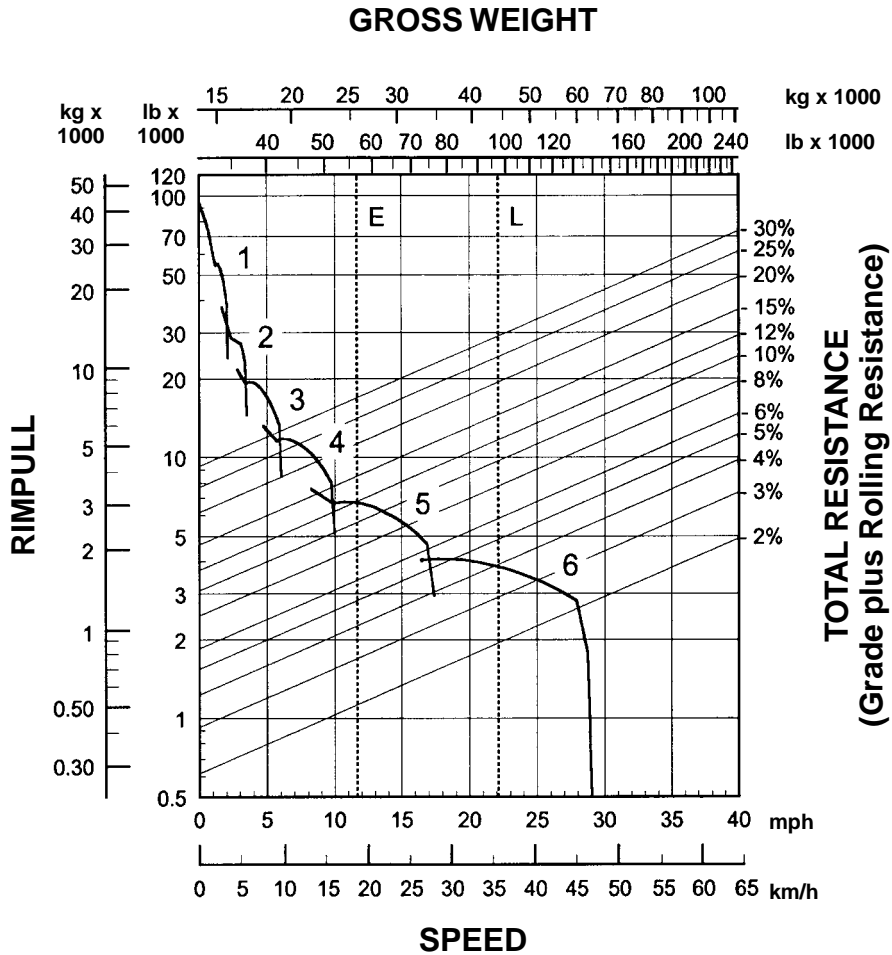

KEY

- 1 — 1st Gear Direct Drive
- 2 — 2nd Gear Direct Drive
- 3 — 3rd Gear Direct Drive
- 4 — 4th Gear Direct Drive
- 5 — 5th Gear Direct Drive
- 6 — 6th Gear Direct Drive

KEY

- E — Empty 25 605 kg (56,450 lb)
- L — Loaded 44 113 kg (97,250 lb)

LOADED

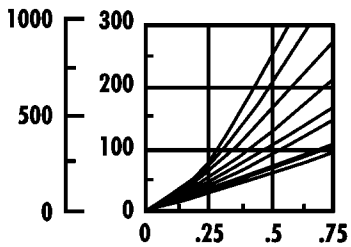
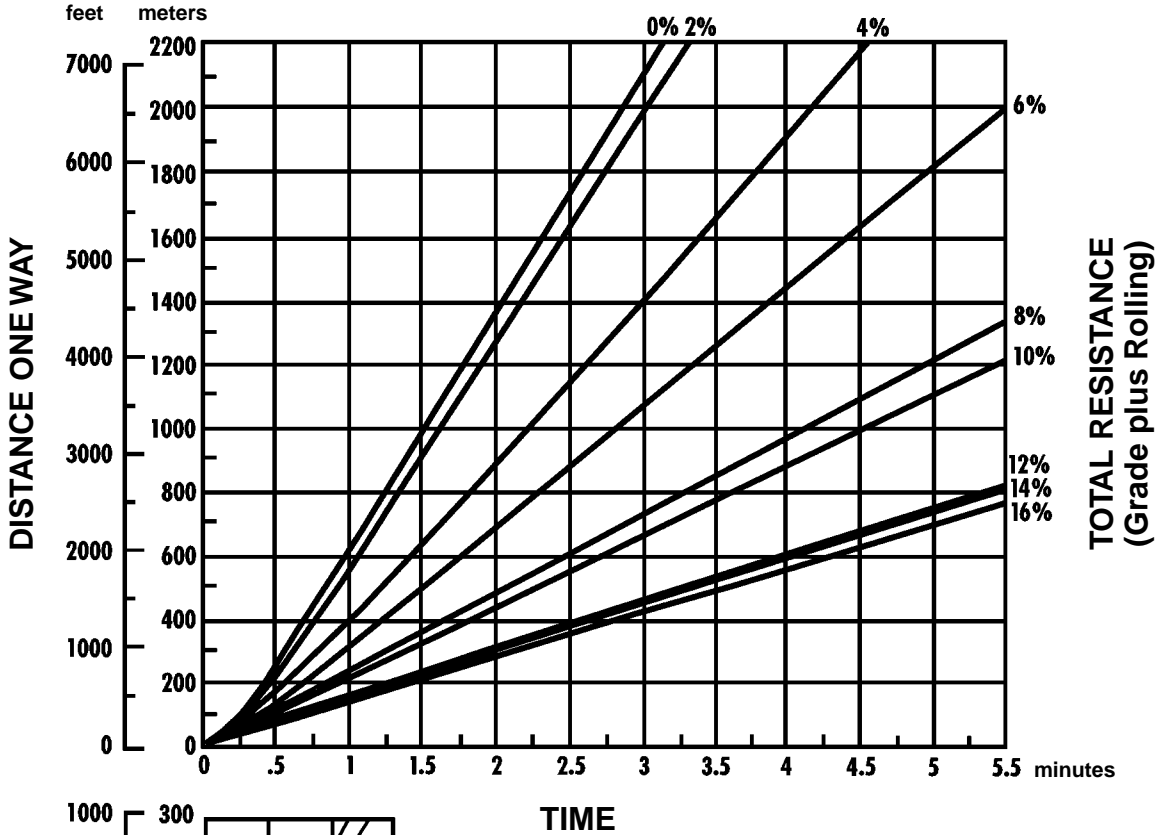

Empty weight: 25 605 kg (56,450 lb)
 Payload: 18 506 kg (40,800 lb)

EMPTY

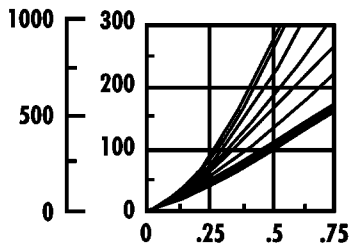
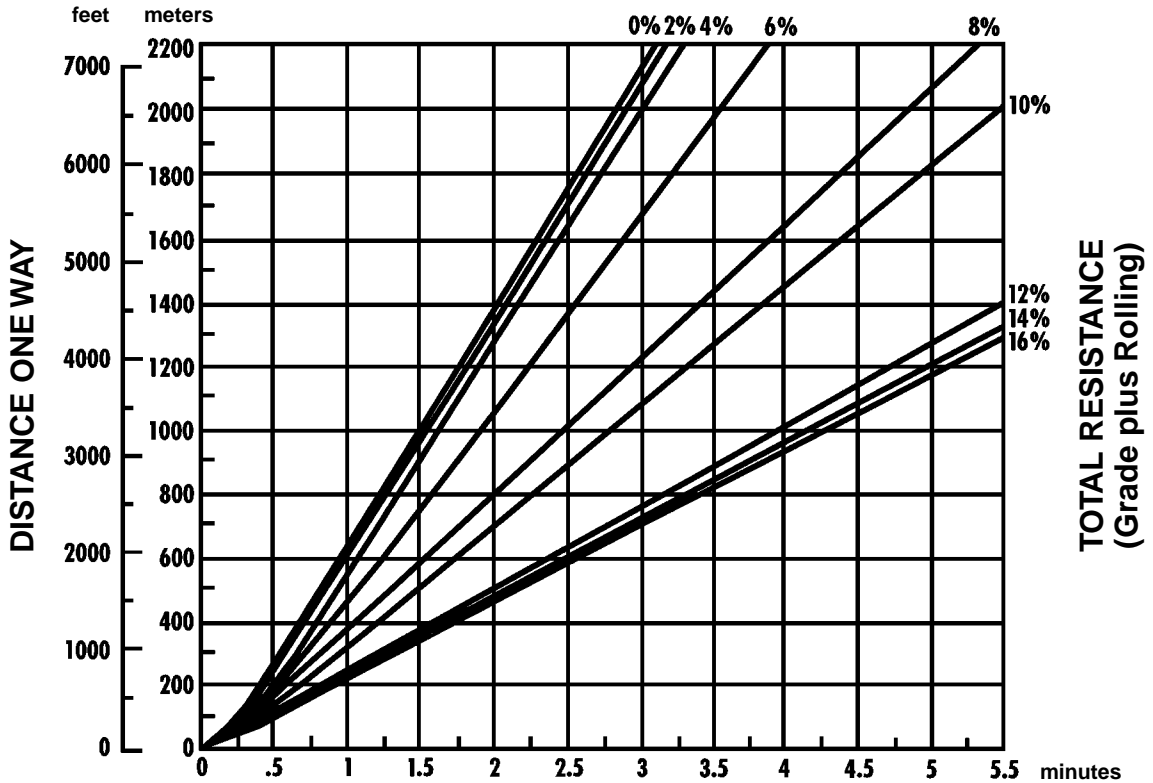

Empty weight: 25 605 kg (56,450 lb)

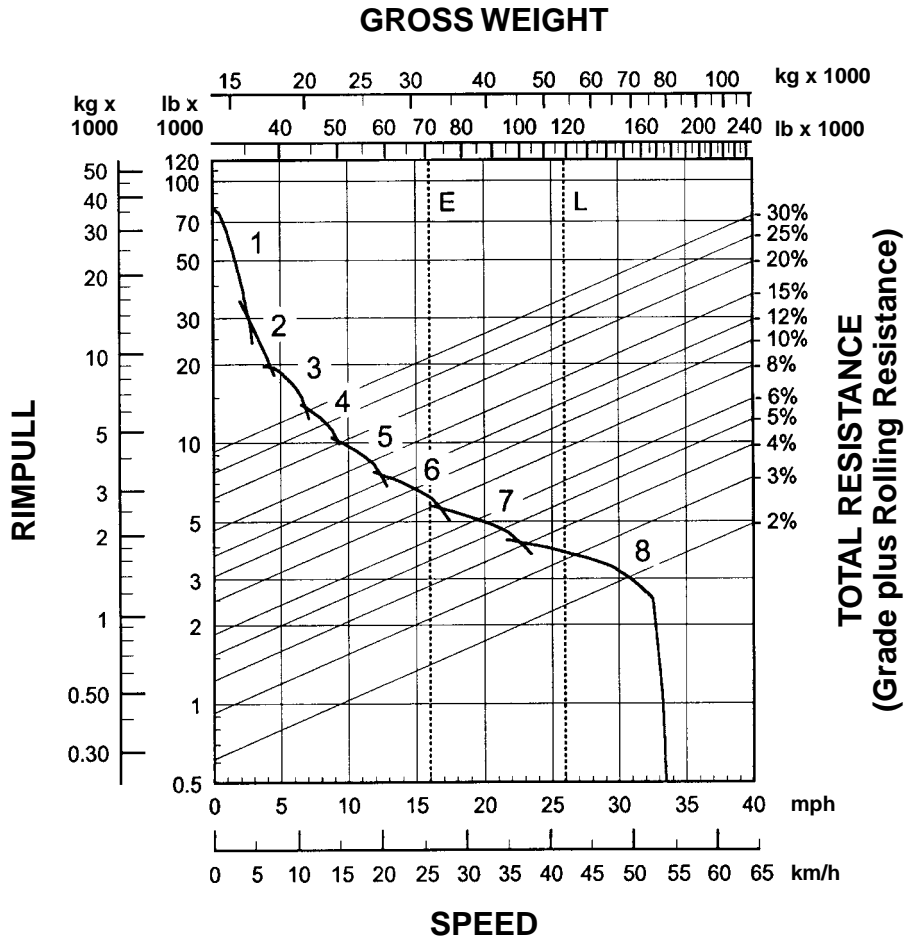

8

KEY

- 1 — 1st Gear Torque Converter Drive
- 2 — 2nd Gear Torque Converter Drive
- 3 — 3rd Gear Direct Drive
- 4 — 4th Gear Direct Drive
- 5 — 5th Gear Direct Drive
- 6 — 6th Gear Direct Drive
- 7 — 7th Gear Direct Drive
- 8 — 8th Gear Direct Drive

KEY

- E — Empty 32 070 kg (70,700 lb)
- L — Loaded 53 843 kg (118,700 lb)

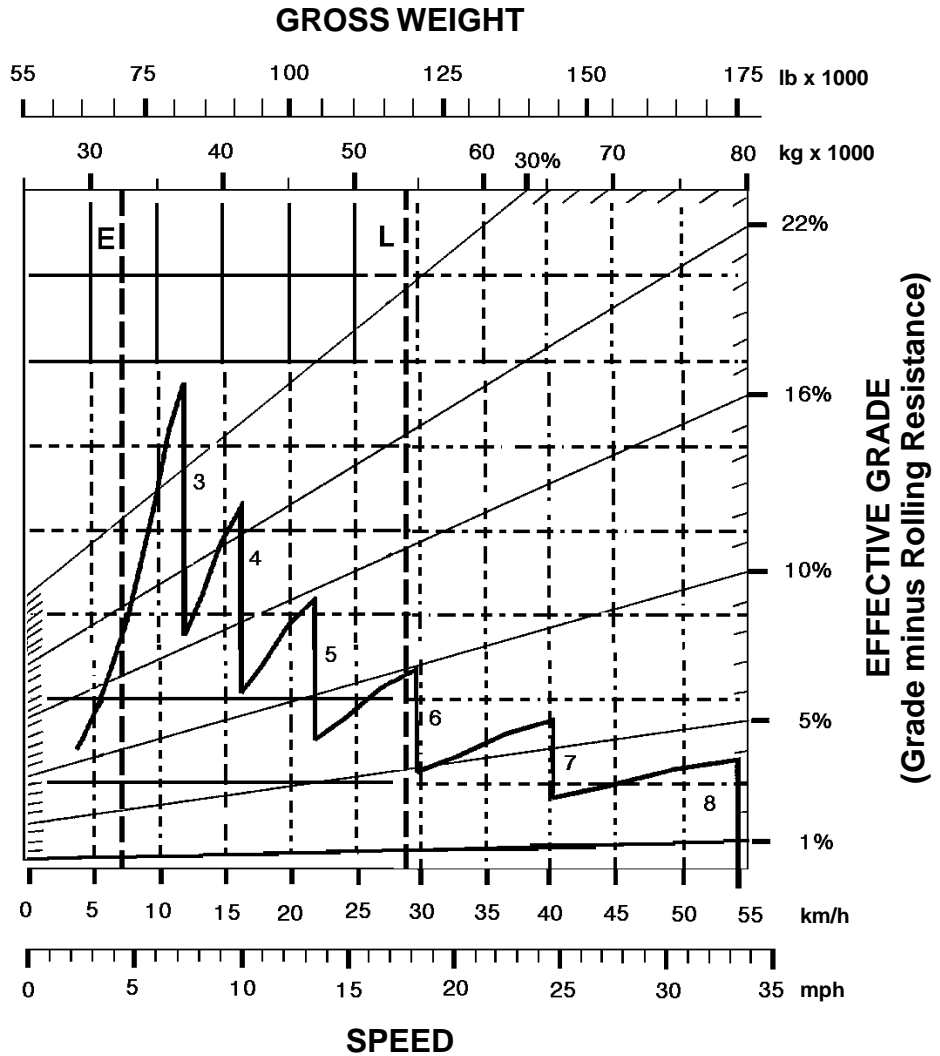

KEY

- 3 — 3rd Gear Direct Drive
- 4 — 4th Gear Direct Drive
- 5 — 5th Gear Direct Drive
- 6 — 6th Gear Direct Drive
- 7 — 7th Gear Direct Drive
- 8 — 8th Gear Direct Drive

KEY

- E — Empty 32 070 kg (70,700 lb)
- L — Loaded 53 843 kg (118,700 lb)

LOADED

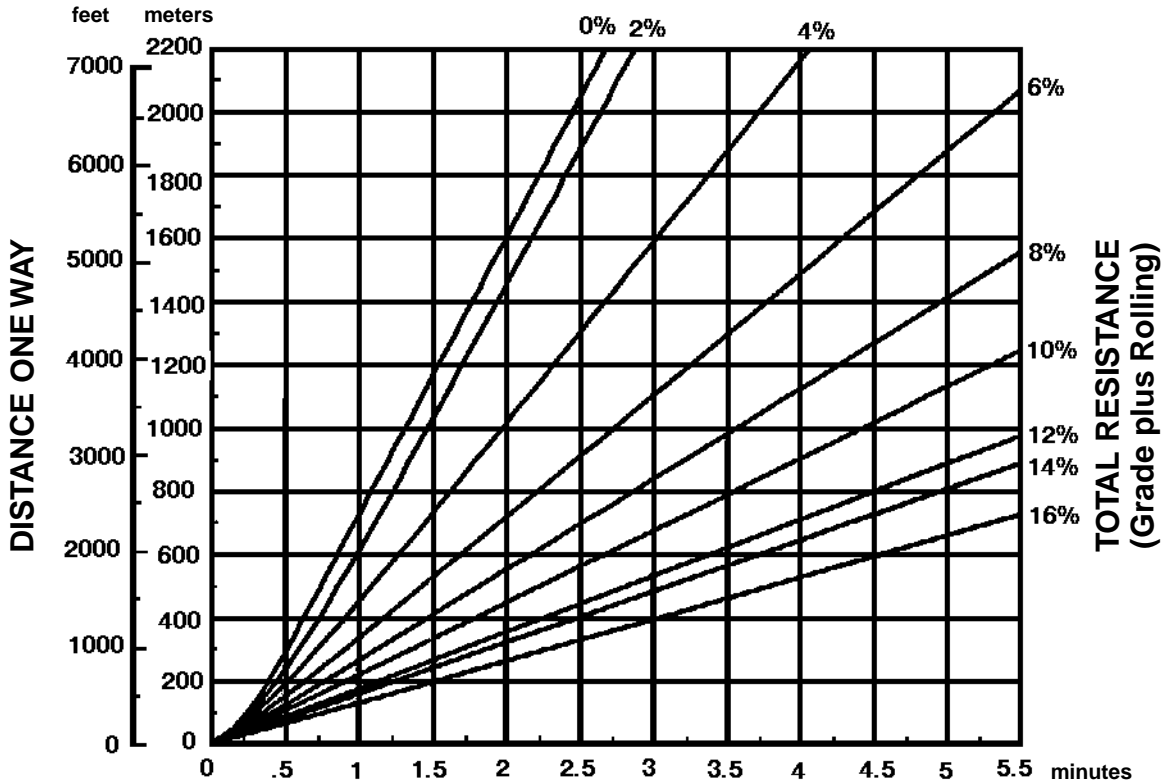

8

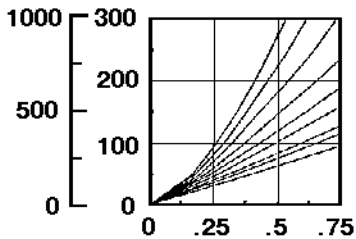

TIME

Empty weight: 32 070 kg (70,700 lb)
 Payload: 21 775 kg (48,000 lb)

EMPTY

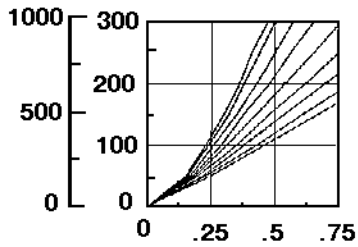
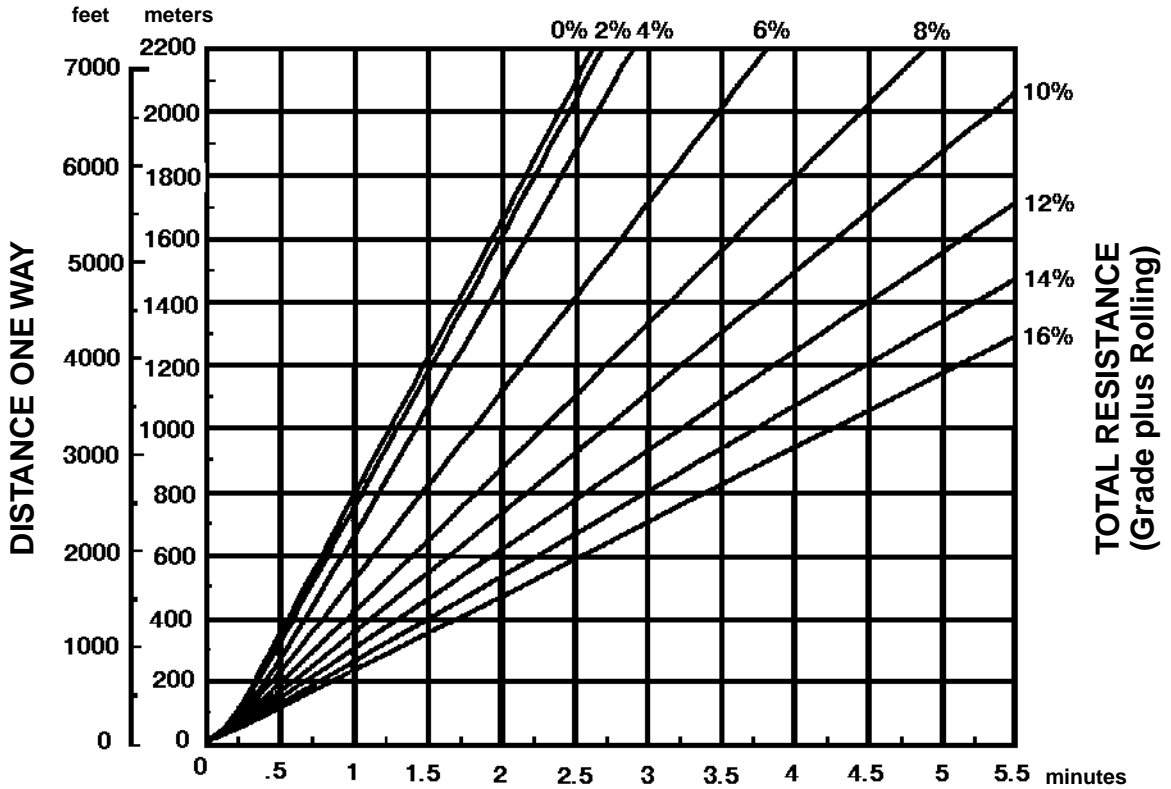

Empty weight: 32 070 kg (70,700 lb)

LOADED

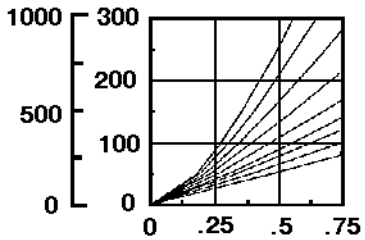
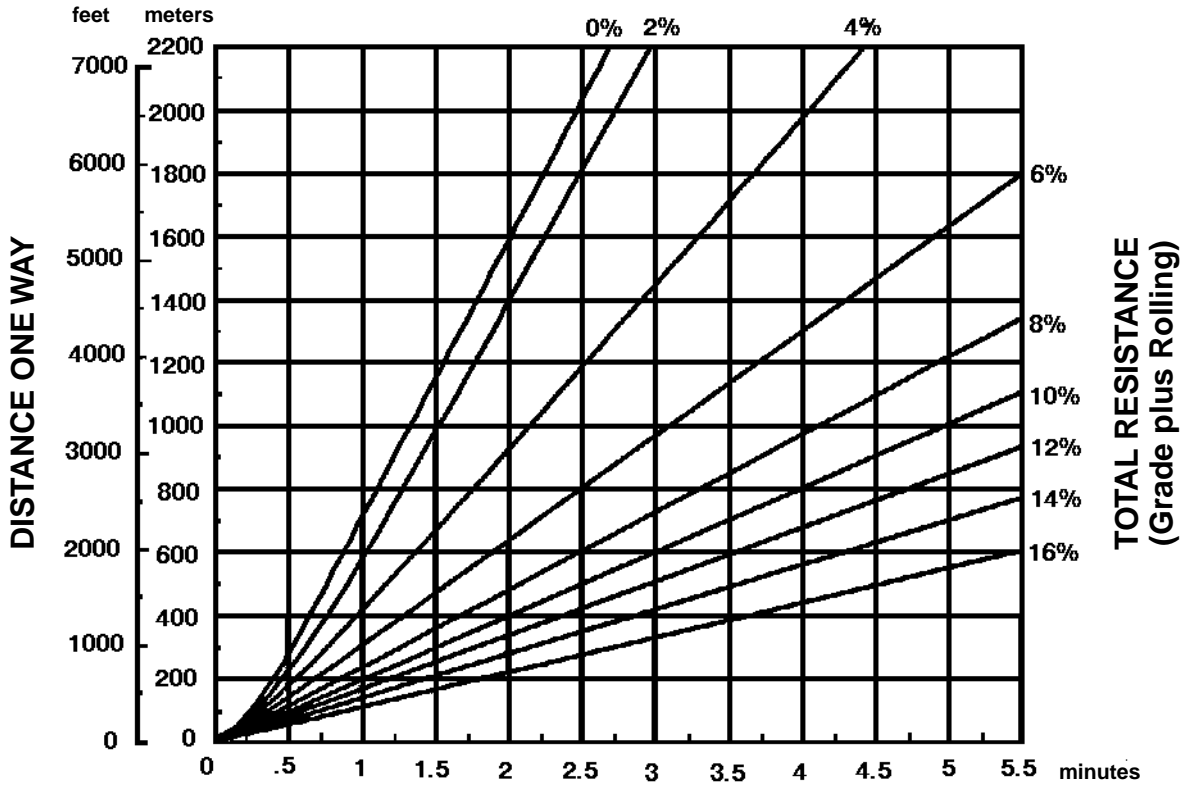

Empty weight: 37 762 kg (83,250 lb)
 Payload: 21 775 kg (48,000 lb)

EMPTY

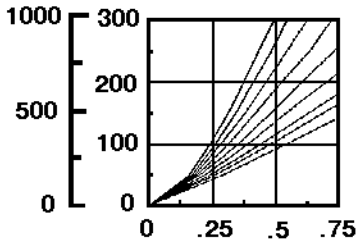
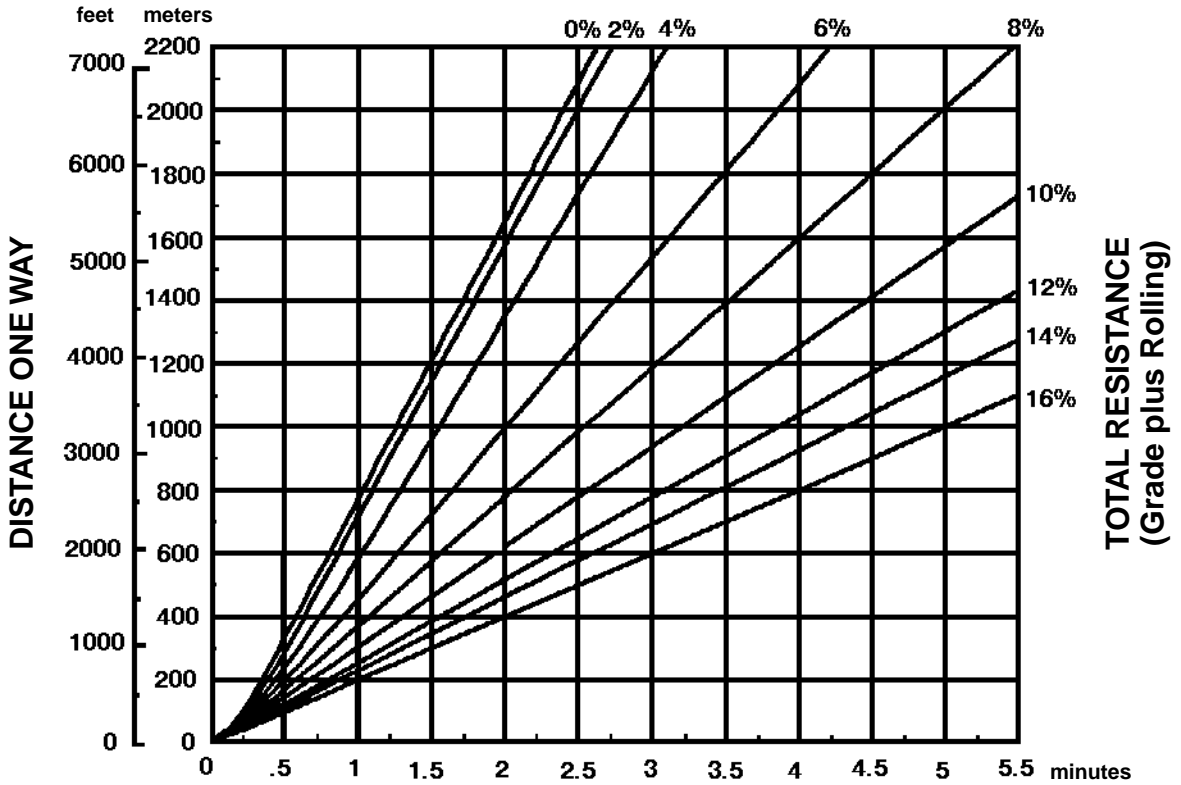

TIME

Empty weight: 37 762 kg (83,250 lb)

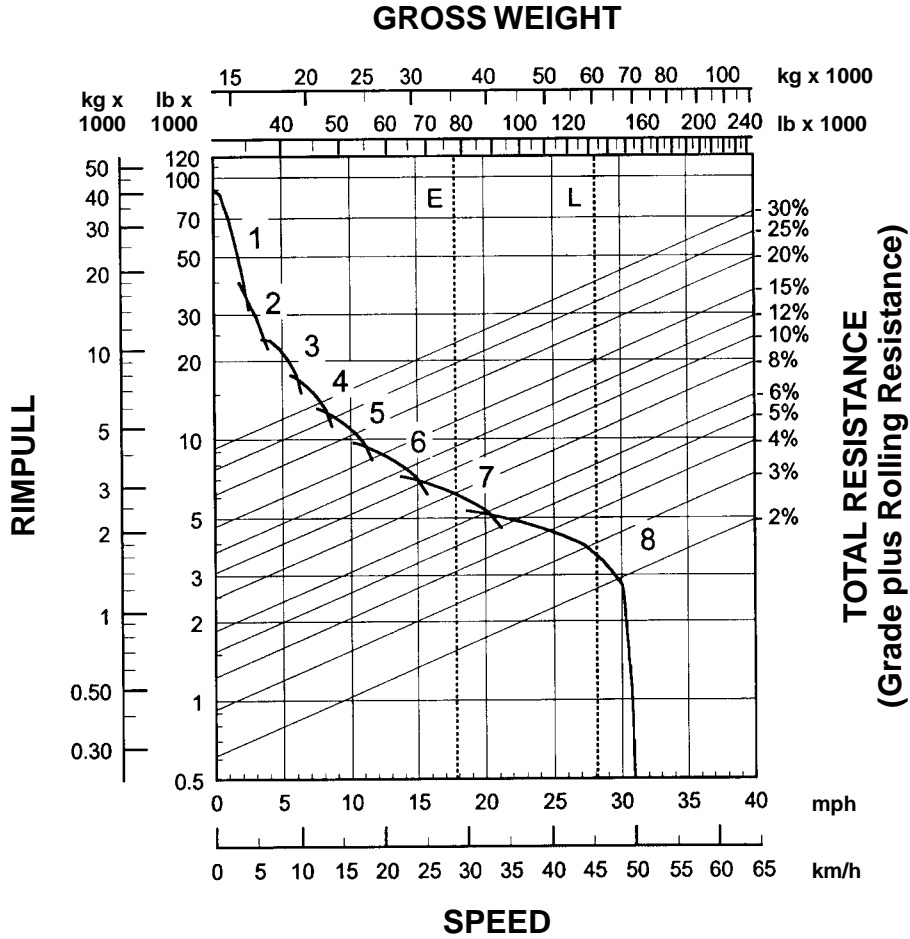

8

KEY

- 1 — 1st Gear Torque Converter Drive
- 2 — 2nd Gear Torque Converter Drive
- 3 — 3rd Gear Direct Drive
- 4 — 4th Gear Direct Drive
- 5 — 5th Gear Direct Drive
- 6 — 6th Gear Direct Drive
- 7 — 7th Gear Direct Drive
- 8 — 8th Gear Direct Drive

KEY

- E — Empty 35 290 kg (77,800 lb)
- L — Loaded 60 238 kg (132,800 lb)

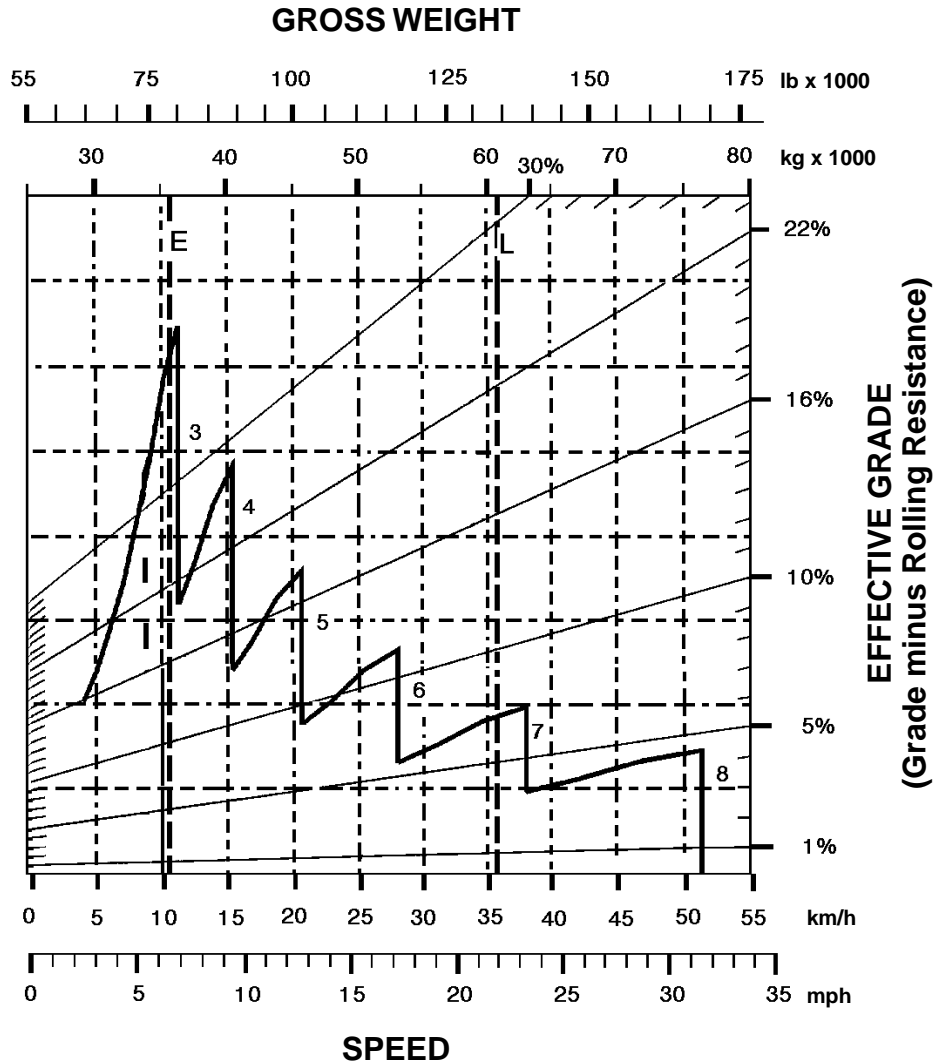

KEY

- 3 — 3rd Gear Direct Drive
- 4 — 4th Gear Direct Drive
- 5 — 5th Gear Direct Drive
- 6 — 6th Gear Direct Drive
- 7 — 7th Gear Direct Drive
- 8 — 8th Gear Direct Drive

KEY

- E — Empty 35 290 kg (77,800 lb)
- L — Loaded 60 238 kg (132,800 lb)

LOADED

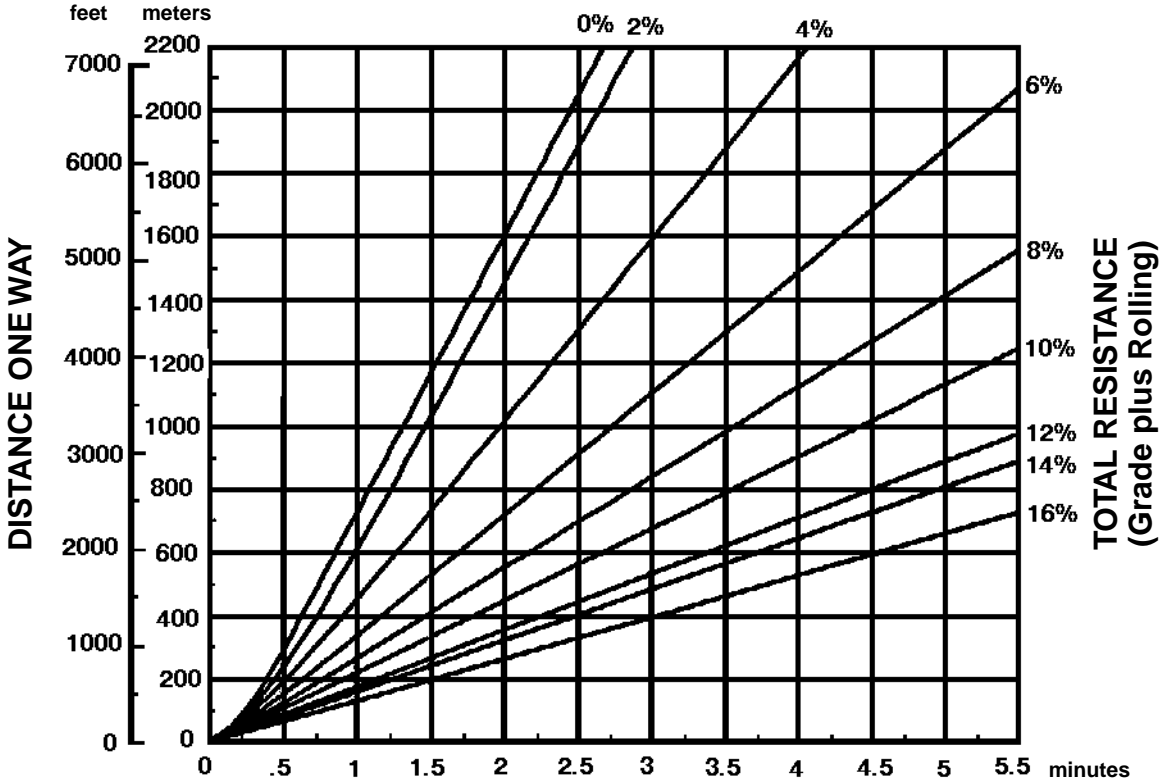

8

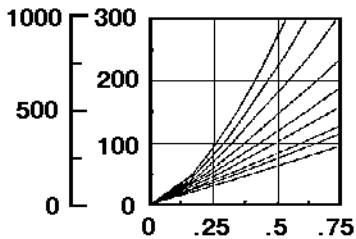

TIME

Empty weight: 32 070 kg (70,700 lb)
 Payload: 21 775 kg (48,000 lb)

EMPTY

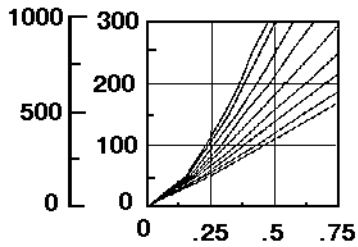
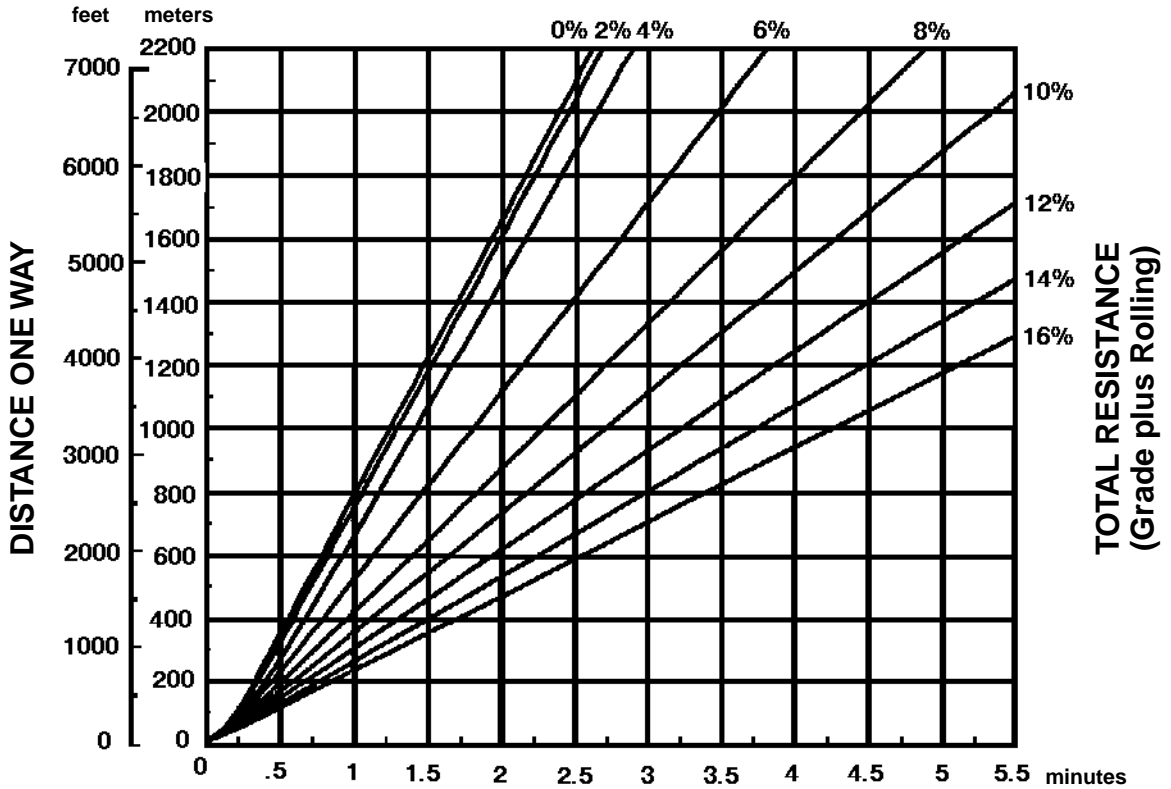

Empty weight: 32 070 kg (70,700 lb)

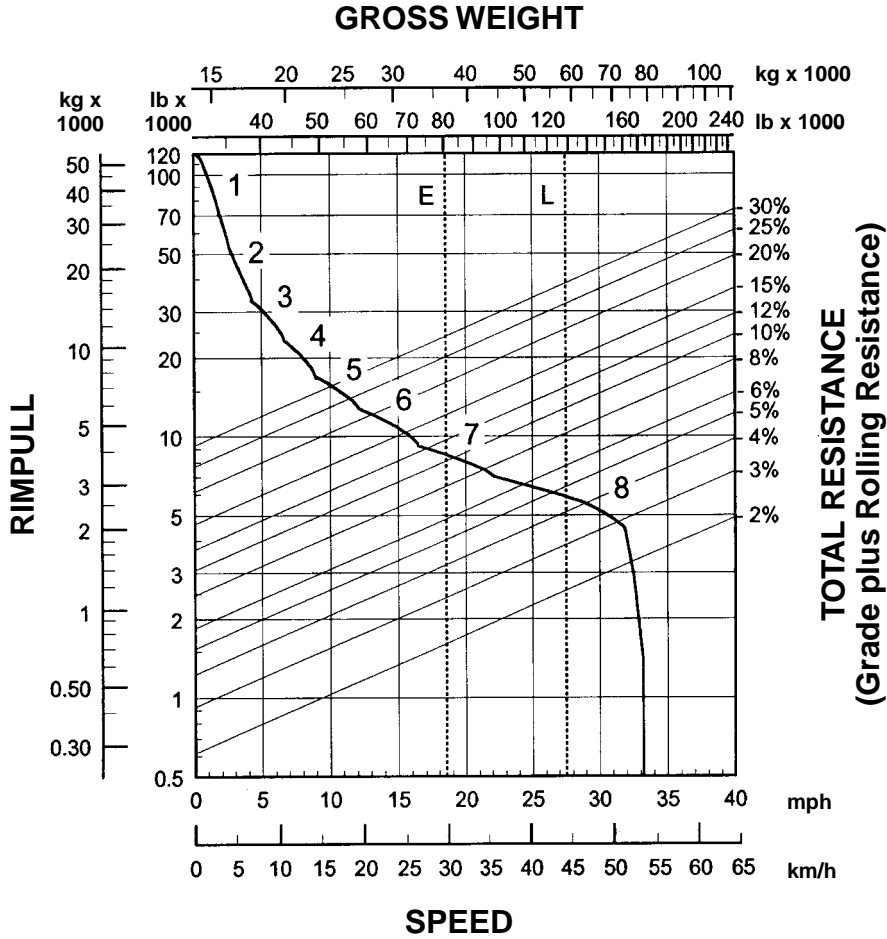

KEY

- 1 — 1st Gear Torque Converter Drive
- 2 — 2nd Gear Torque Converter Drive
- 3 — 3rd Gear Direct Drive
- 4 — 4th Gear Direct Drive
- 5 — 5th Gear Direct Drive
- 6 — 6th Gear Direct Drive
- 7 — 7th Gear Direct Drive
- 8 — 8th Gear Direct Drive

KEY

- E — Empty 36 538 kg (80,550 lb)
- L — Loaded 58 311 kg (128,550 lb)

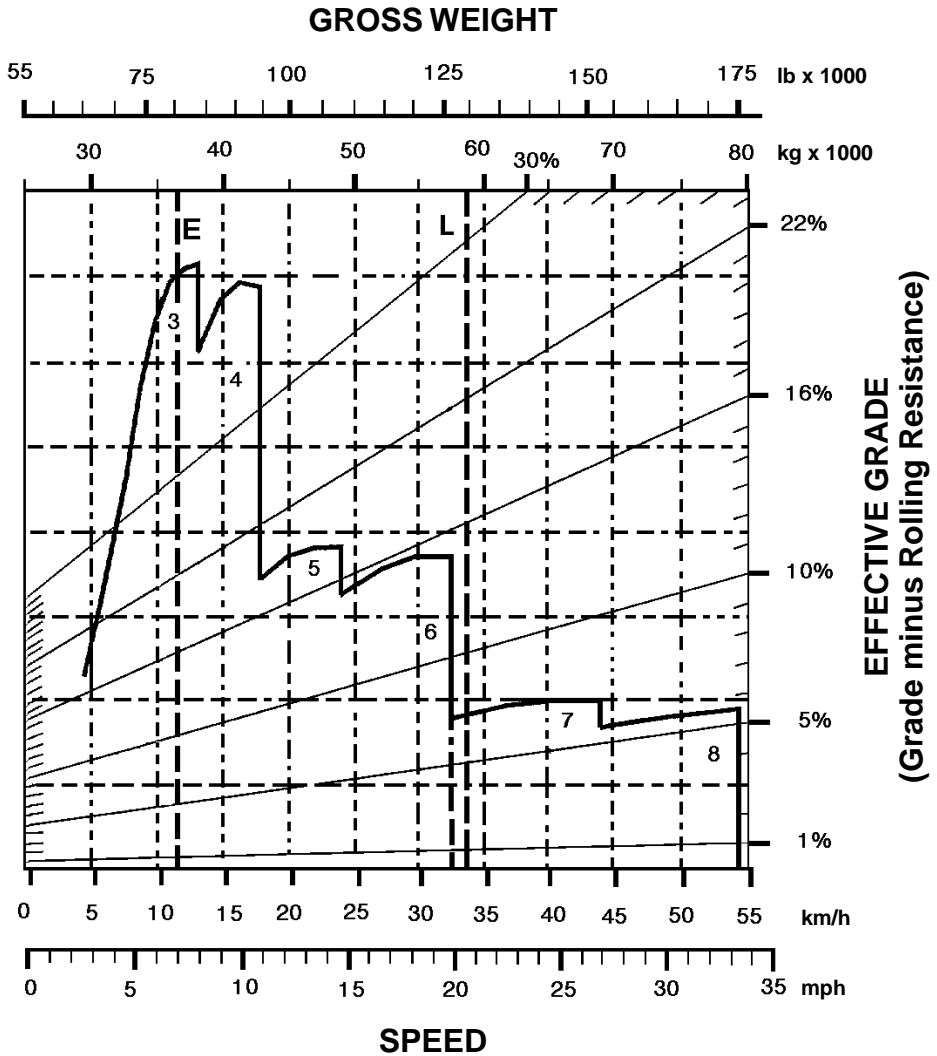

KEY

- 3 — 3rd Gear Direct Drive
- 4 — 4th Gear Direct Drive
- 5 — 5th Gear Direct Drive
- 6 — 6th Gear Direct Drive
- 7 — 7th Gear Direct Drive
- 8 — 8th Gear Direct Drive

KEY

- E — Empty 36 538 kg (80,550 lb)
- L — Loaded 58 311 kg (128,550 lb)

627F Travel Time — Loaded
 • 33.25R29 Tires
 • Standard and Push-Pull

Wheel Tractor-Scrapers

LOADED

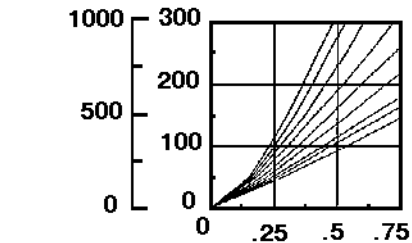
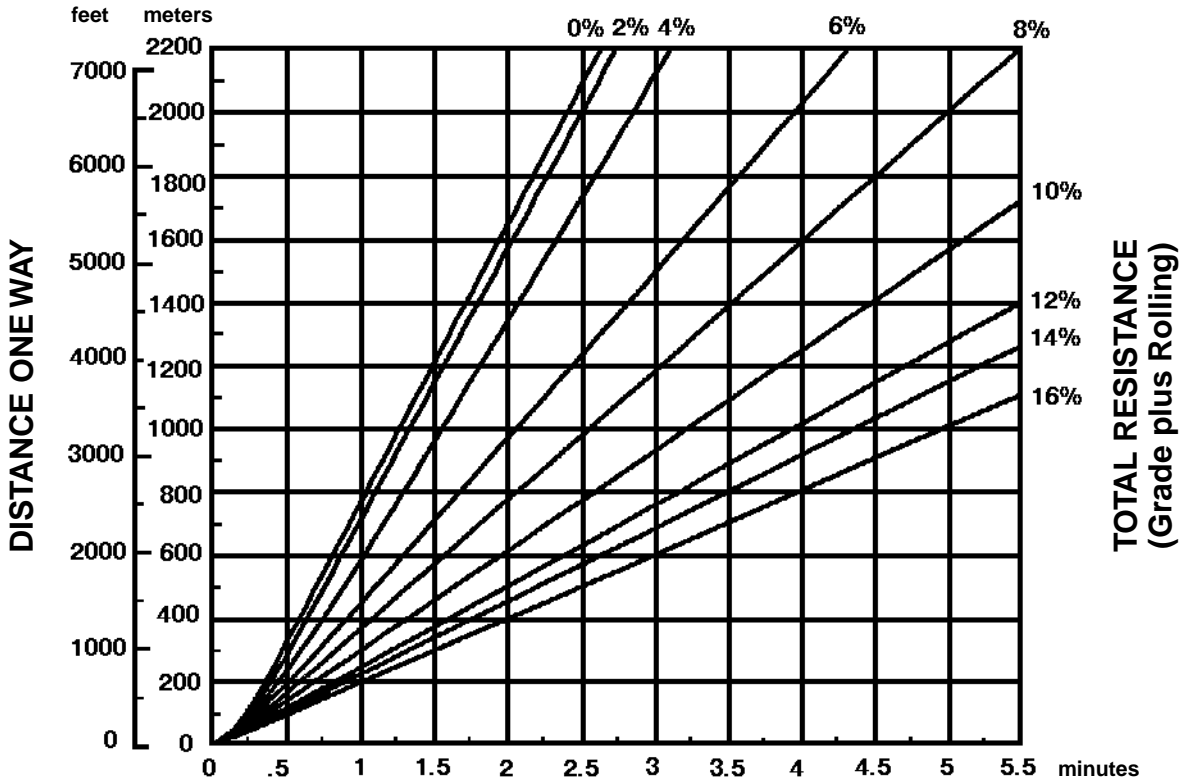

TIME

Empty weight: 36 538 kg (80,550 lb)
 Payload: 21 775 kg (48,000 lb)

Wheel Tractor-Scrapers

627F Travel Time — Empty

- 33.25R29 Tires
- Standard and Push-Pull

EMPTY

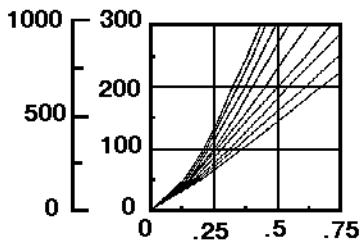
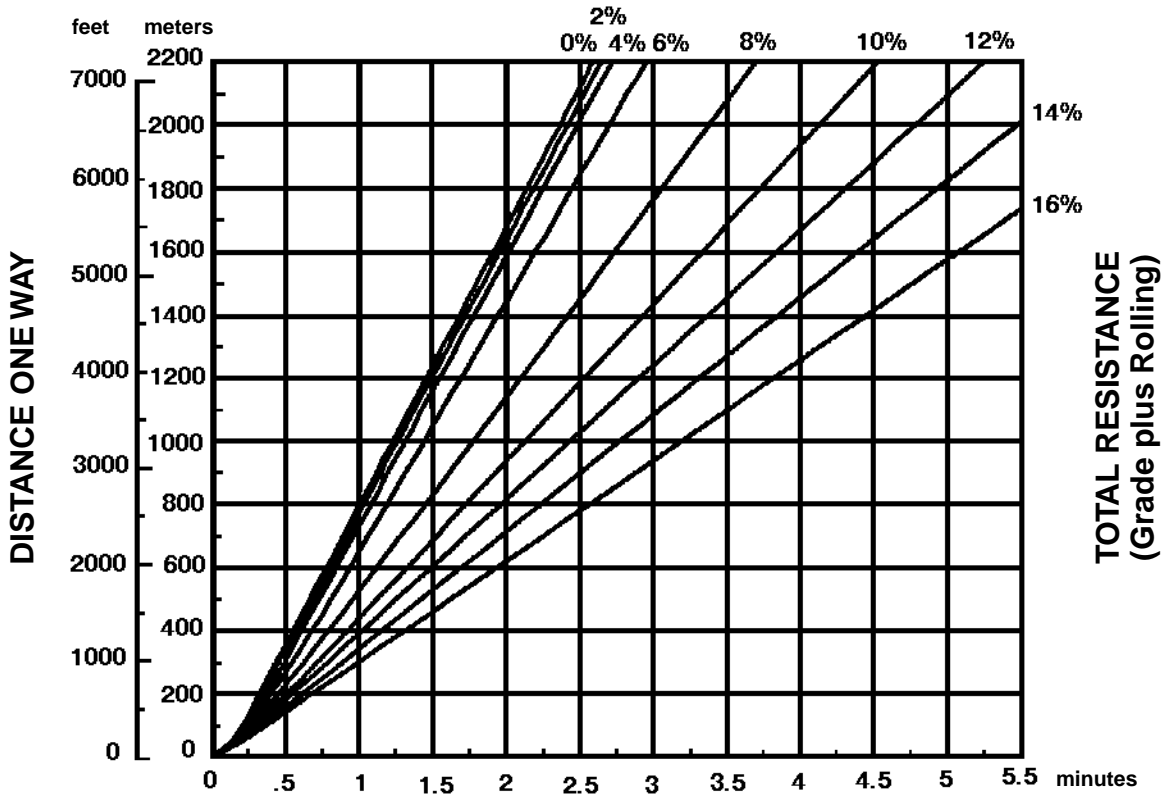

Empty weight: 36 538 kg (80,550 lb)

LOADED

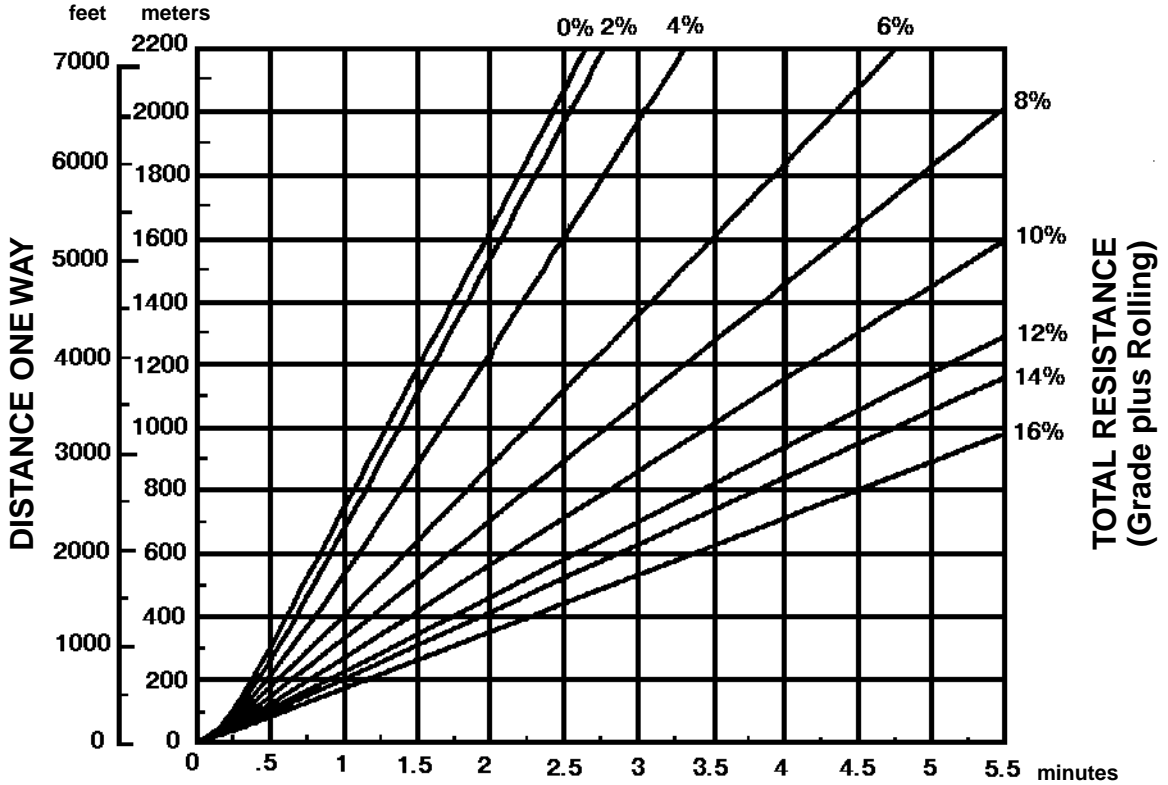

8

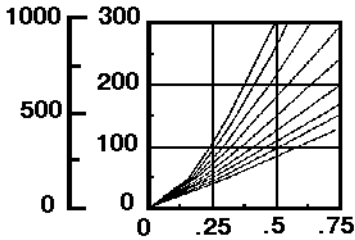

TIME

Empty weight: 42 230 kg (93,100 lb)
 Payload: 21 775 kg (48,000 lb)

EMPTY

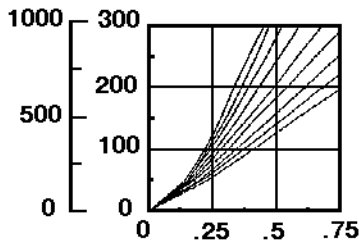
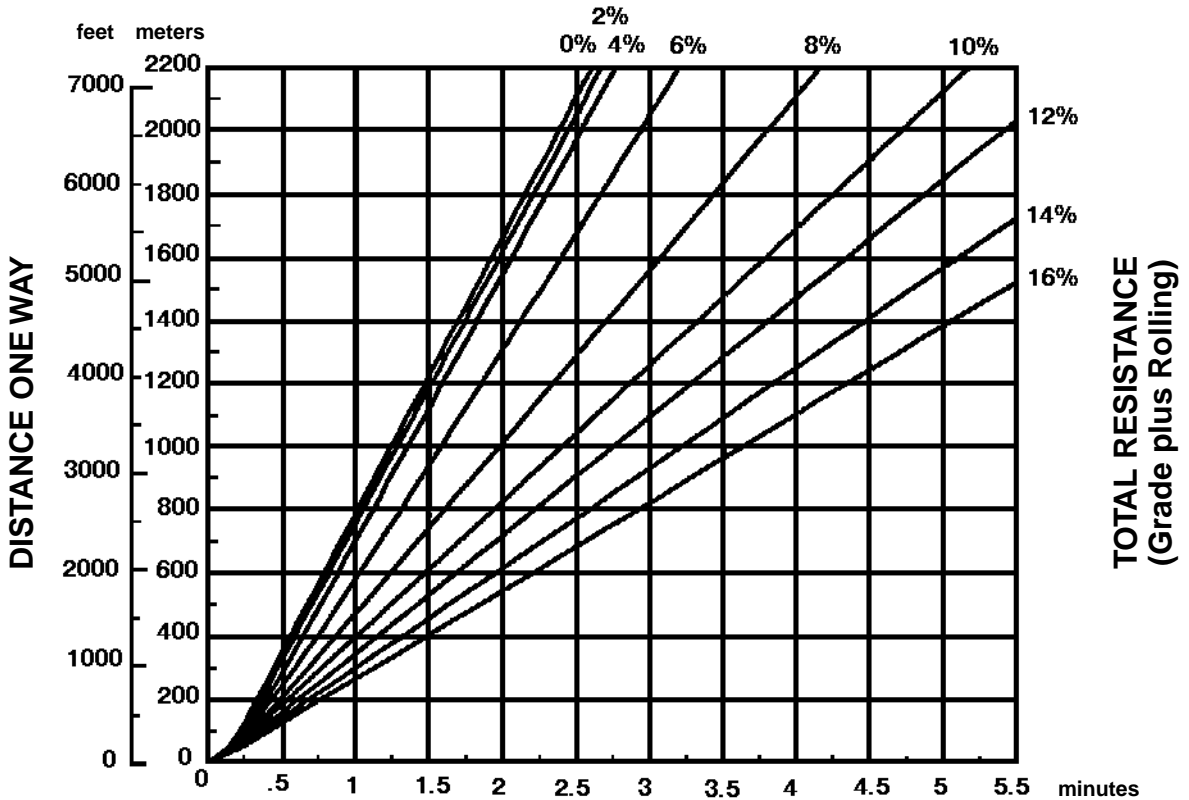

Empty weight: 42 230 kg (93,100 lb)

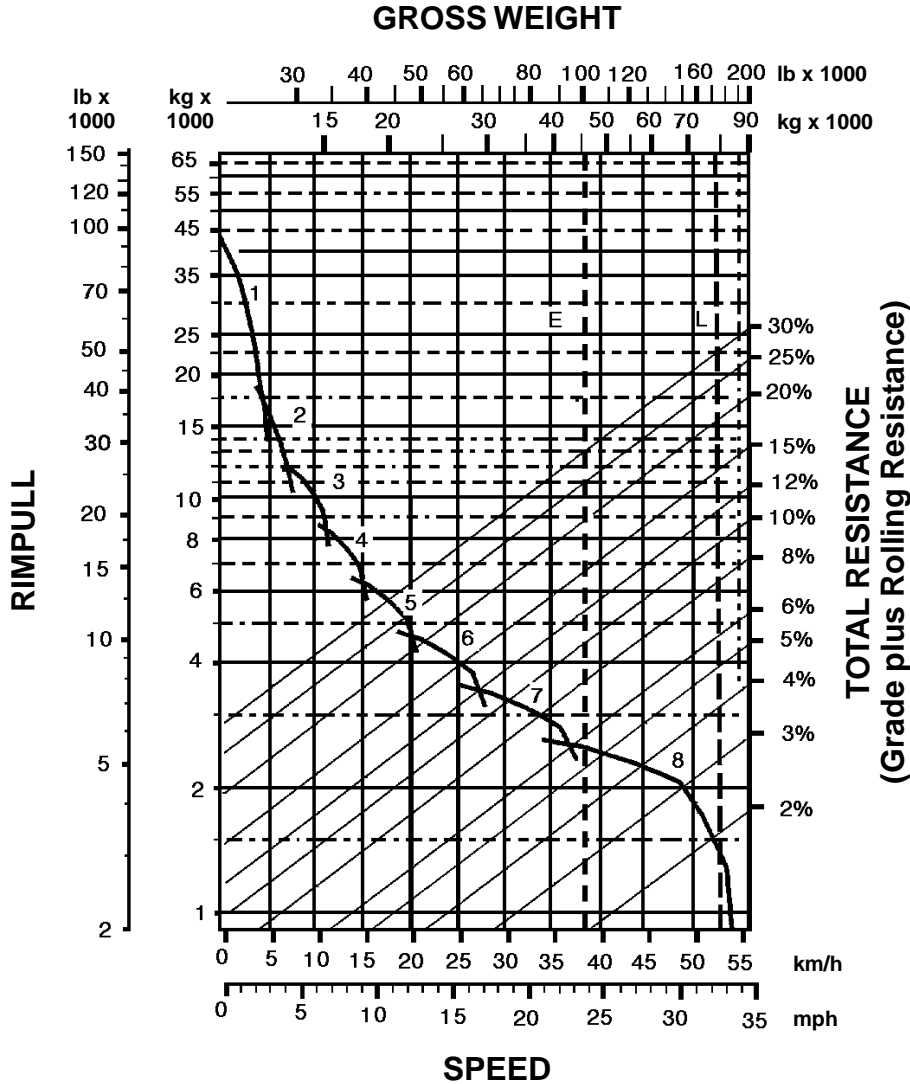

KEY

- 1 — 1st Gear Torque Converter Drive
- 2 — 2nd Gear Torque Converter Drive
- 3 — 3rd Gear Direct Drive
- 4 — 4th Gear Direct Drive
- 5 — 5th Gear Direct Drive
- 6 — 6th Gear Direct Drive
- 7 — 7th Gear Direct Drive
- 8 — 8th Gear Direct Drive

KEY

- E — Empty 45 400 kg (100,000 lb)
- L — Loaded 79 420 kg (175,000 lb)

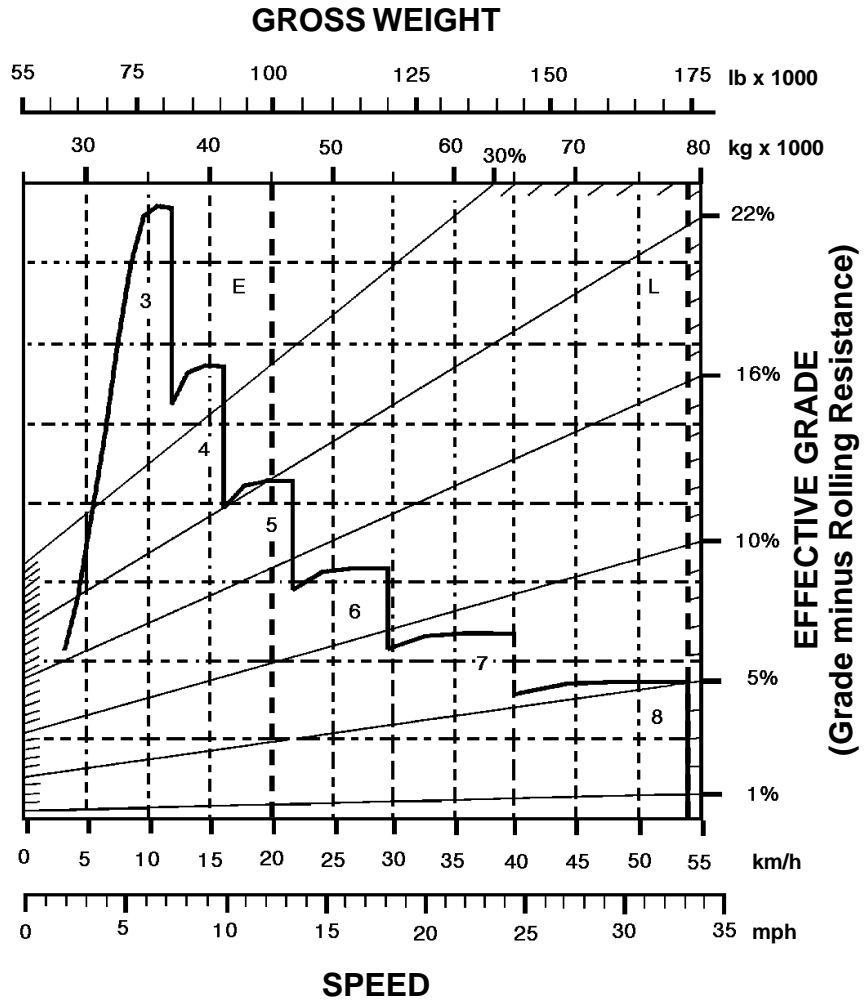

KEY

- 3 — 3rd Gear Direct Drive
- 4 — 4th Gear Direct Drive
- 5 — 5th Gear Direct Drive
- 6 — 6th Gear Direct Drive
- 7 — 7th Gear Direct Drive
- 8 — 8th Gear Direct Drive

KEY

- E — Empty 45 400 kg (100,000 lb)
- L — Loaded 79 420 kg (175,000 lb)

LOADED

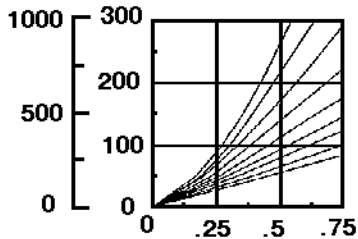
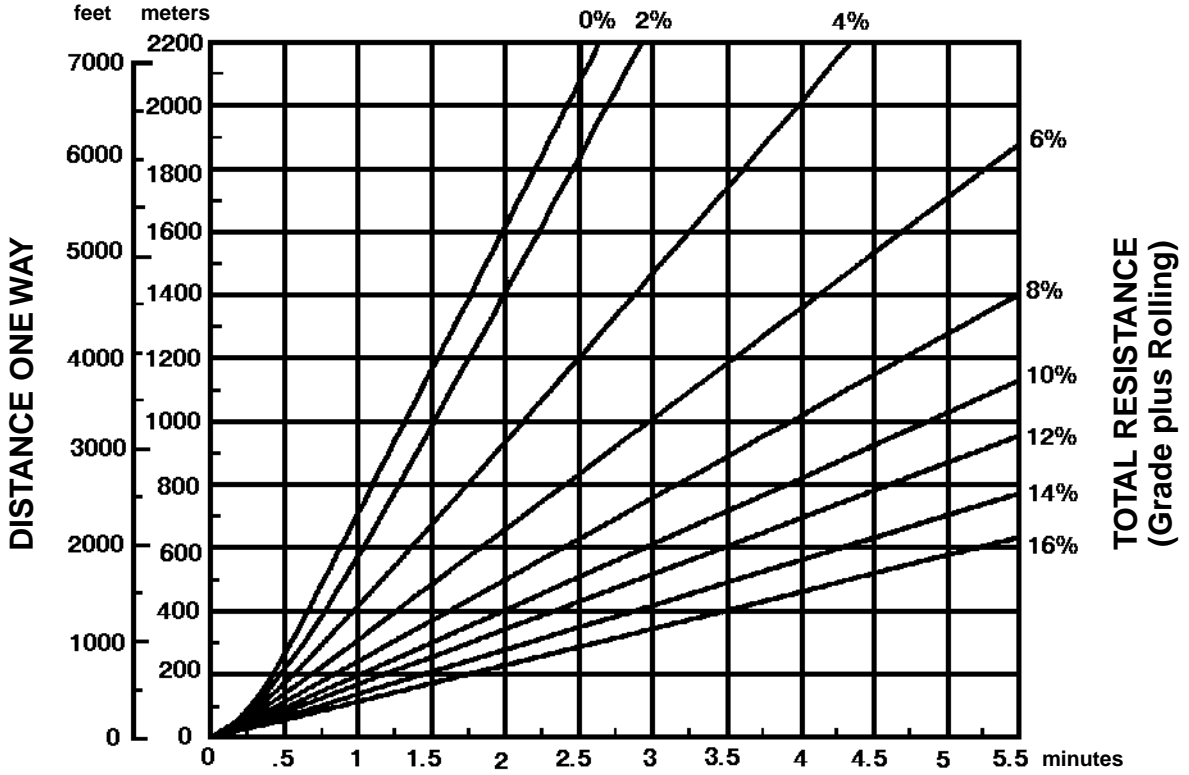

Empty weight: 45 400 kg (100,000 lb)
 Payload: 34 020 kg (75,000 lb)

EMPTY

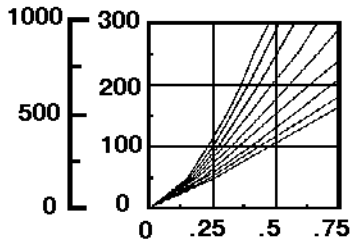
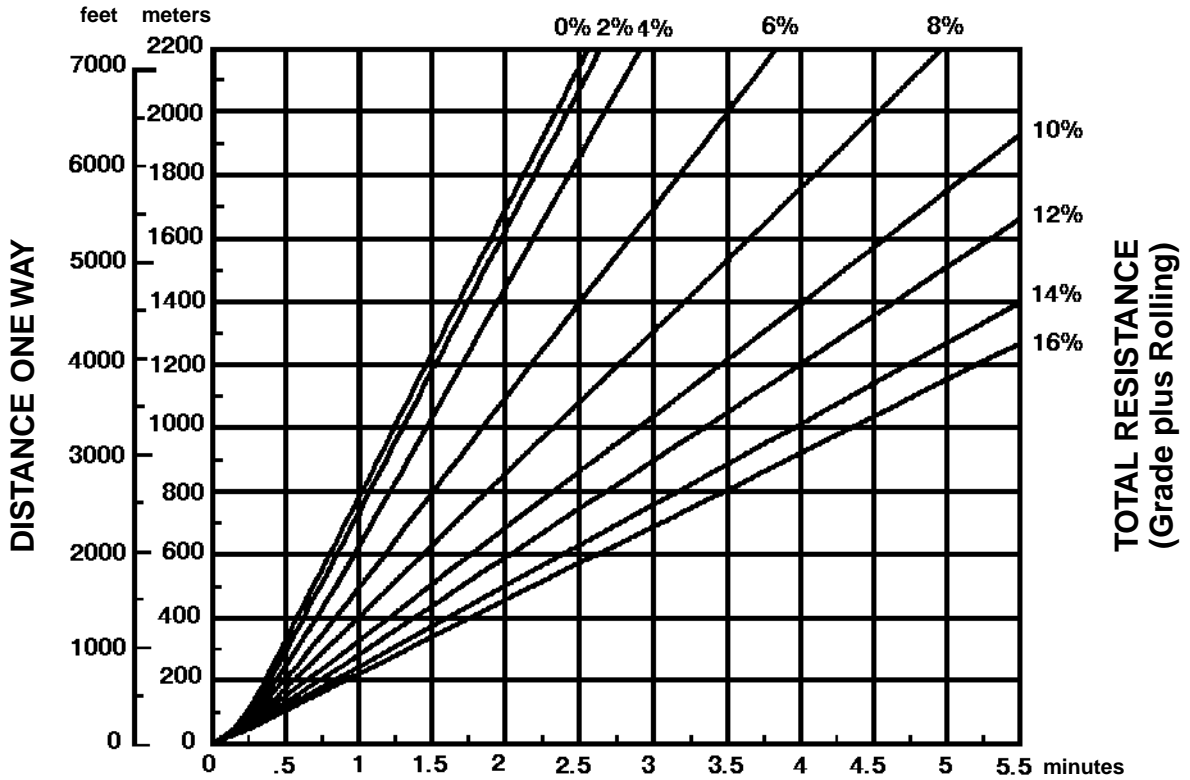

TIME

Empty weight: 45 400 kg (100,000 lb)

LOADED

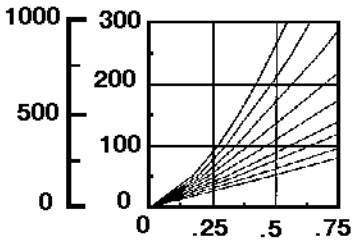
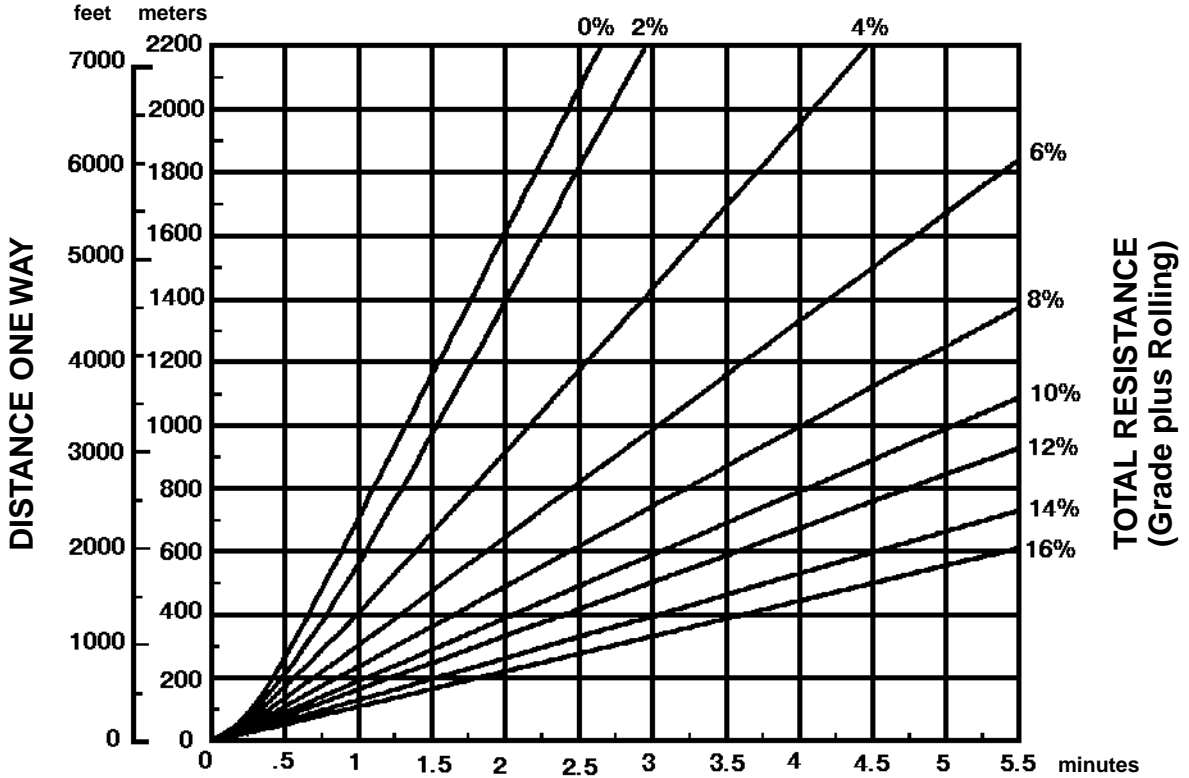

TIME

Empty weight: 45 980 kg (101,370 lb)
 Payload: 34 020 kg (75,000 lb)

EMPTY

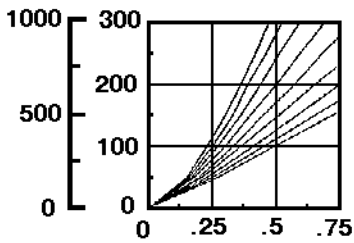
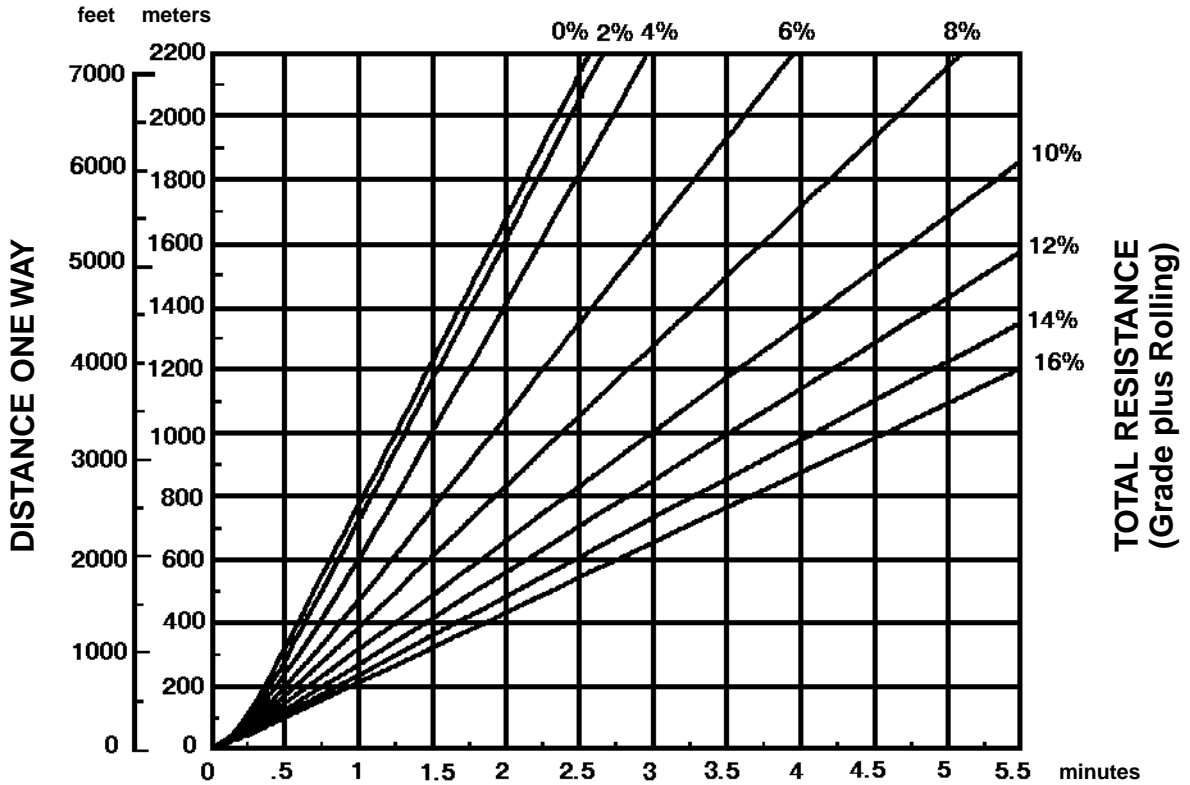

Empty weight: 45 980 kg (101,370 lb)

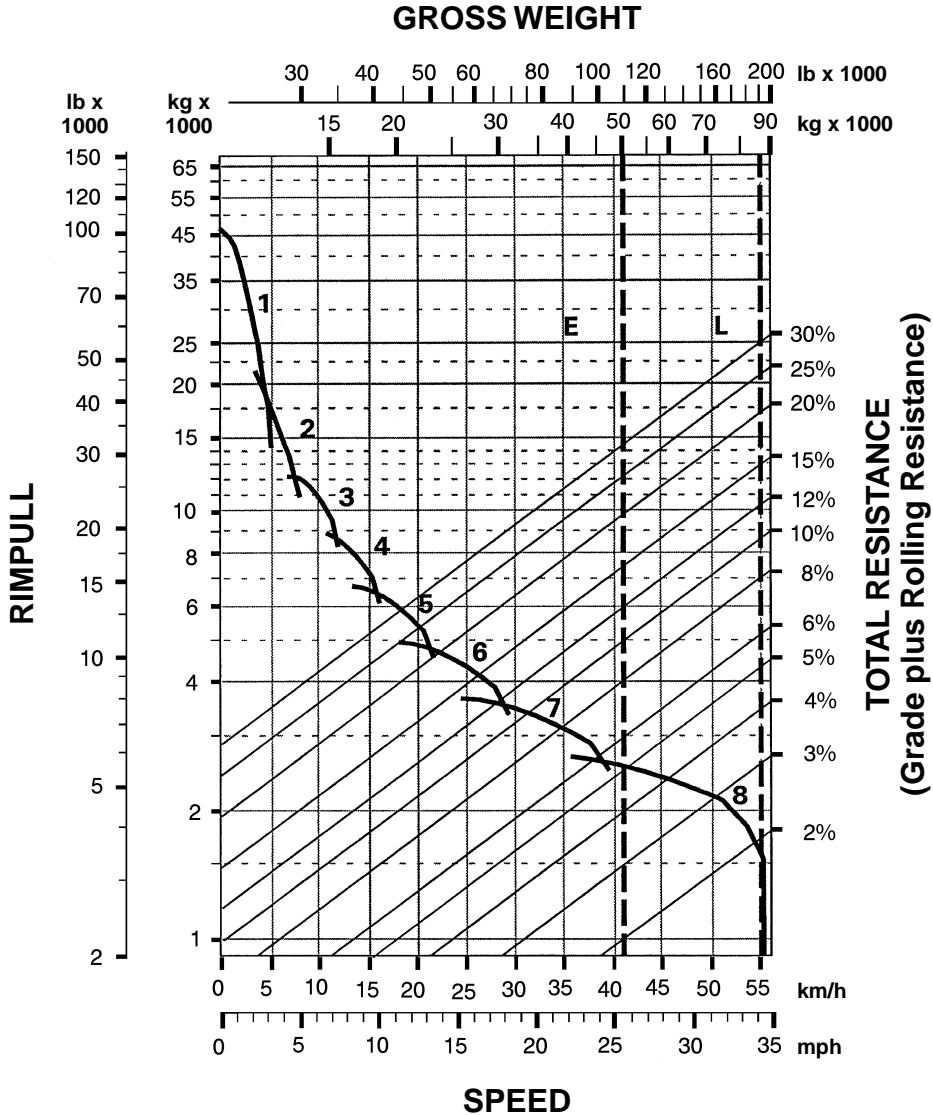

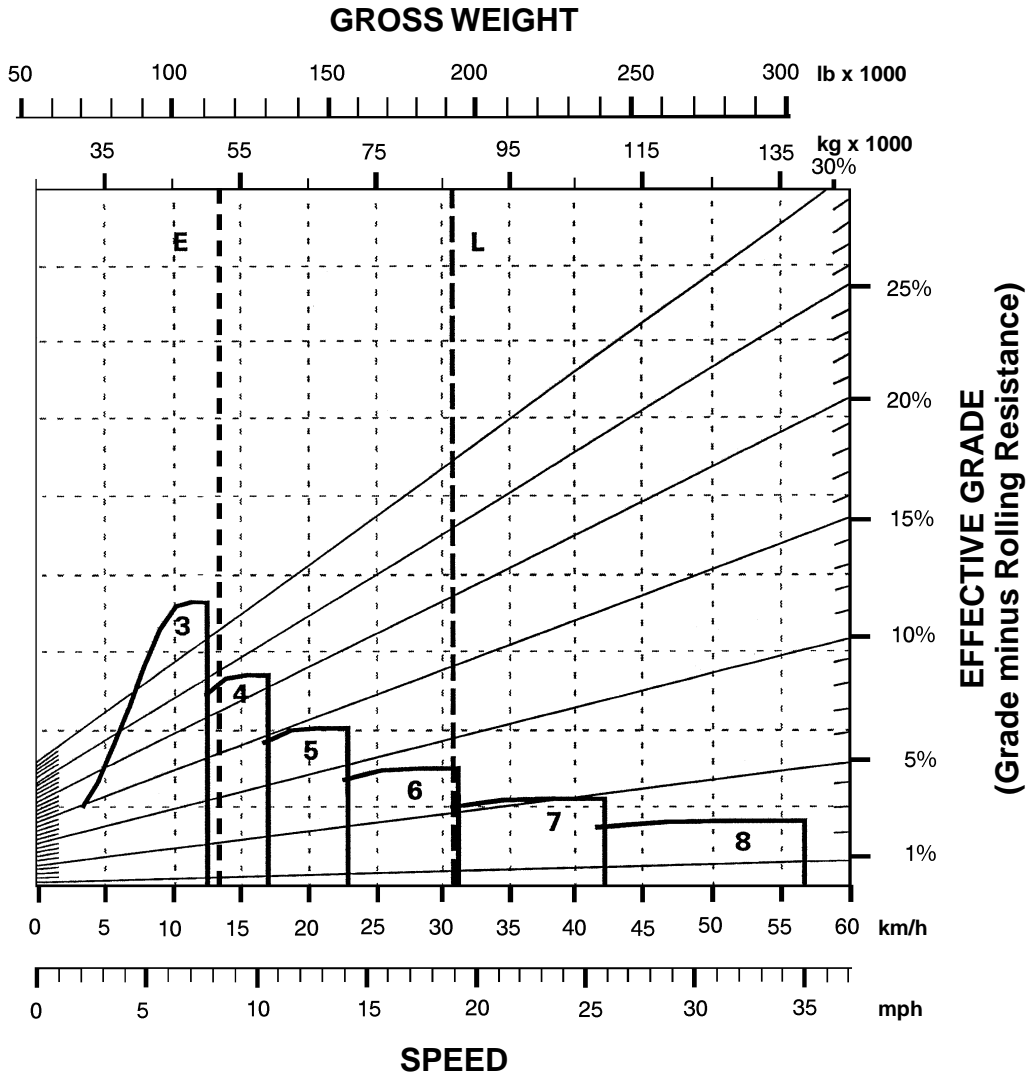

KEY

- 3 — 3rd Gear Direct Drive
- 4 — 4th Gear Direct Drive
- 5 — 5th Gear Direct Drive
- 6 — 6th Gear Direct Drive
- 7 — 7th Gear Direct Drive
- 8 — 8th Gear Direct Drive

KEY

- E — Empty 51 100 kg (112,670 lb)
- L — Loaded 88 300 kg (194,670 lb)

LOADED

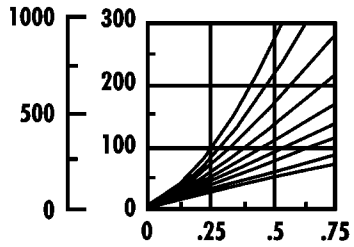
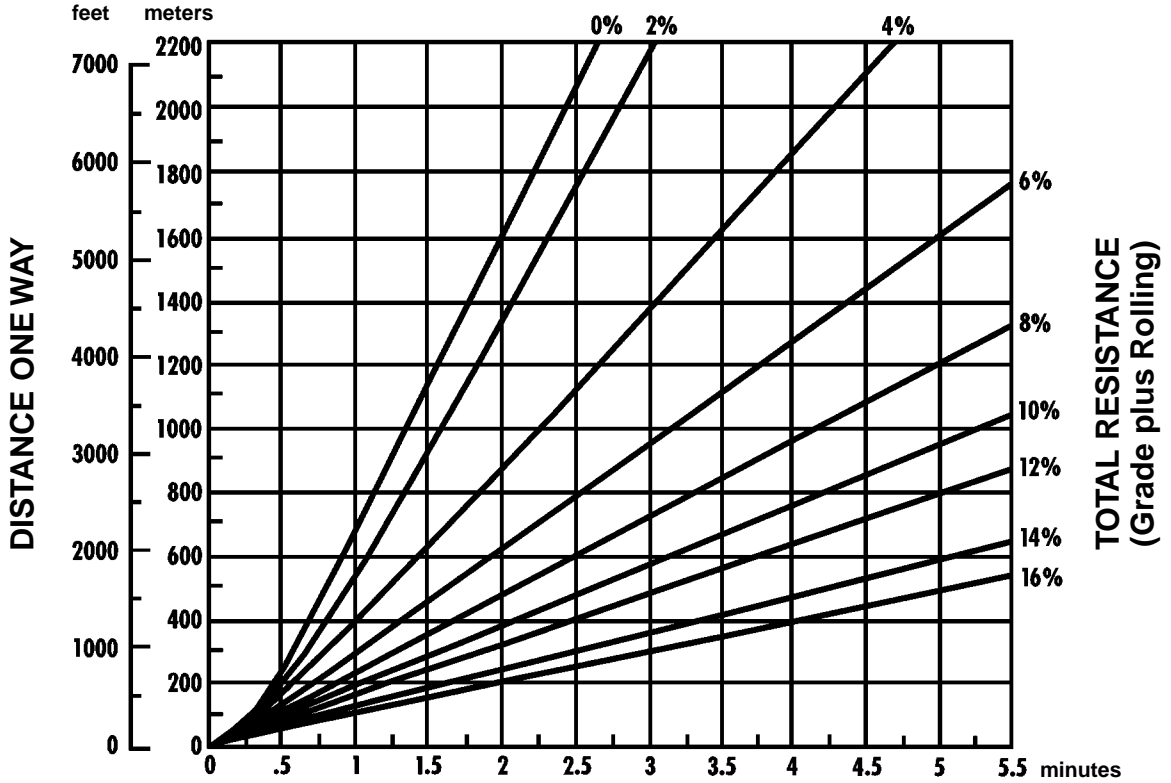

Empty weight: 51 100 kg (112,670 lb)
 Payload: 37 200 kg (82,000 lb)

EMPTY

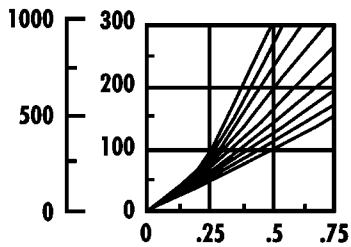
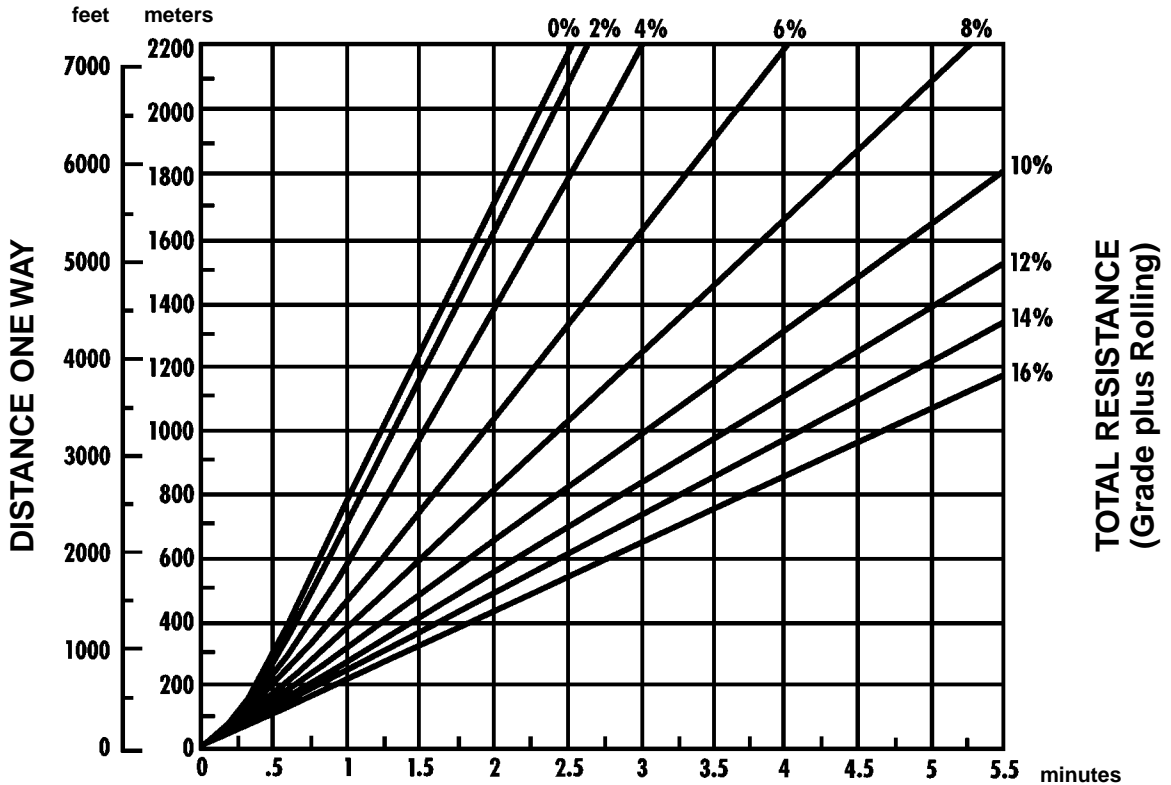

Empty weight: 51 100 kg (112,670 lb)

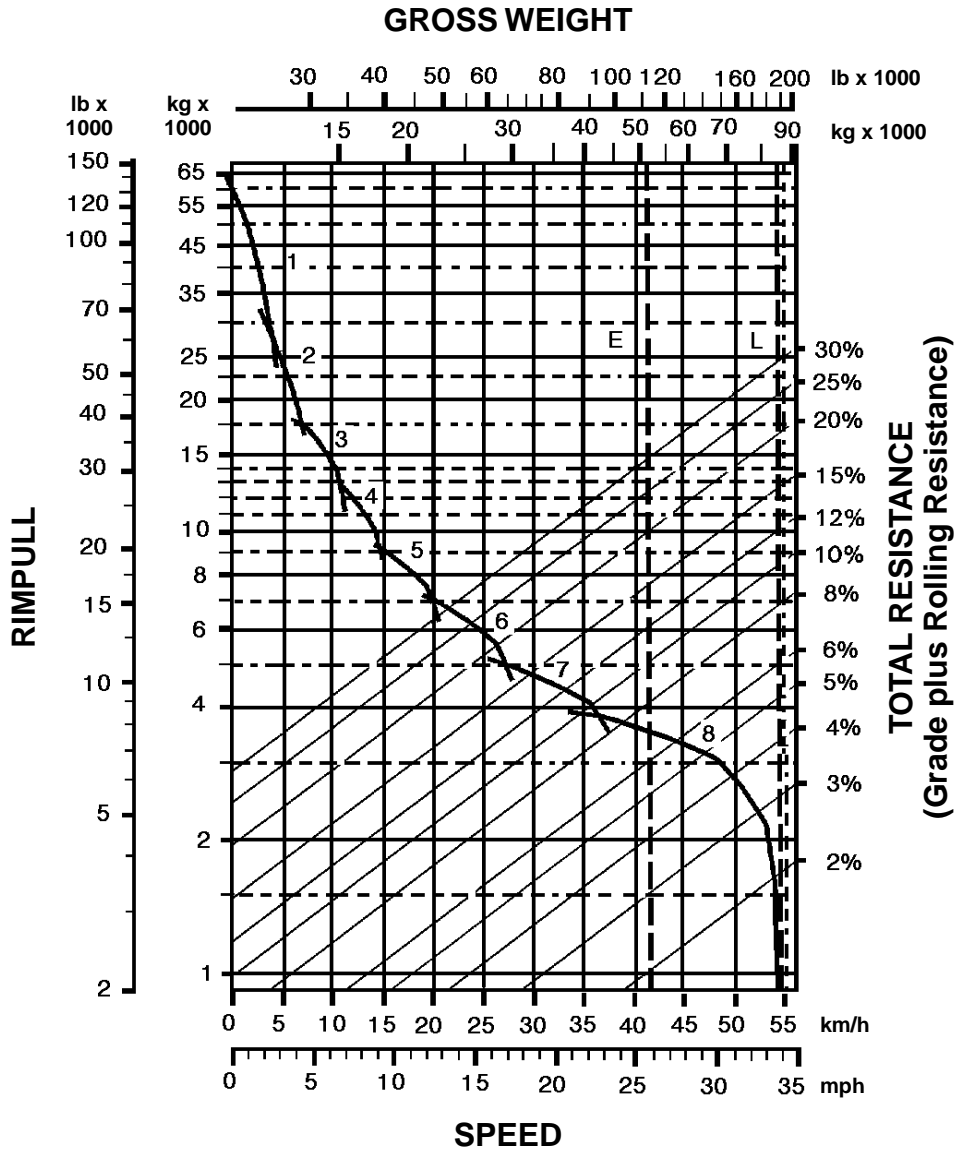

KEY

- 1 — 1st Gear Torque Converter Drive
- 2 — 2nd Gear Torque Converter Drive
- 3 — 3rd Gear Direct Drive
- 4 — 4th Gear Direct Drive
- 5 — 5th Gear Direct Drive
- 6 — 6th Gear Direct Drive
- 7 — 7th Gear Direct Drive
- 8 — 8th Gear Direct Drive

KEY

- E — Empty 51 000 kg (112,320 lb)
- L — Loaded 85 020 kg (187,320 lb)

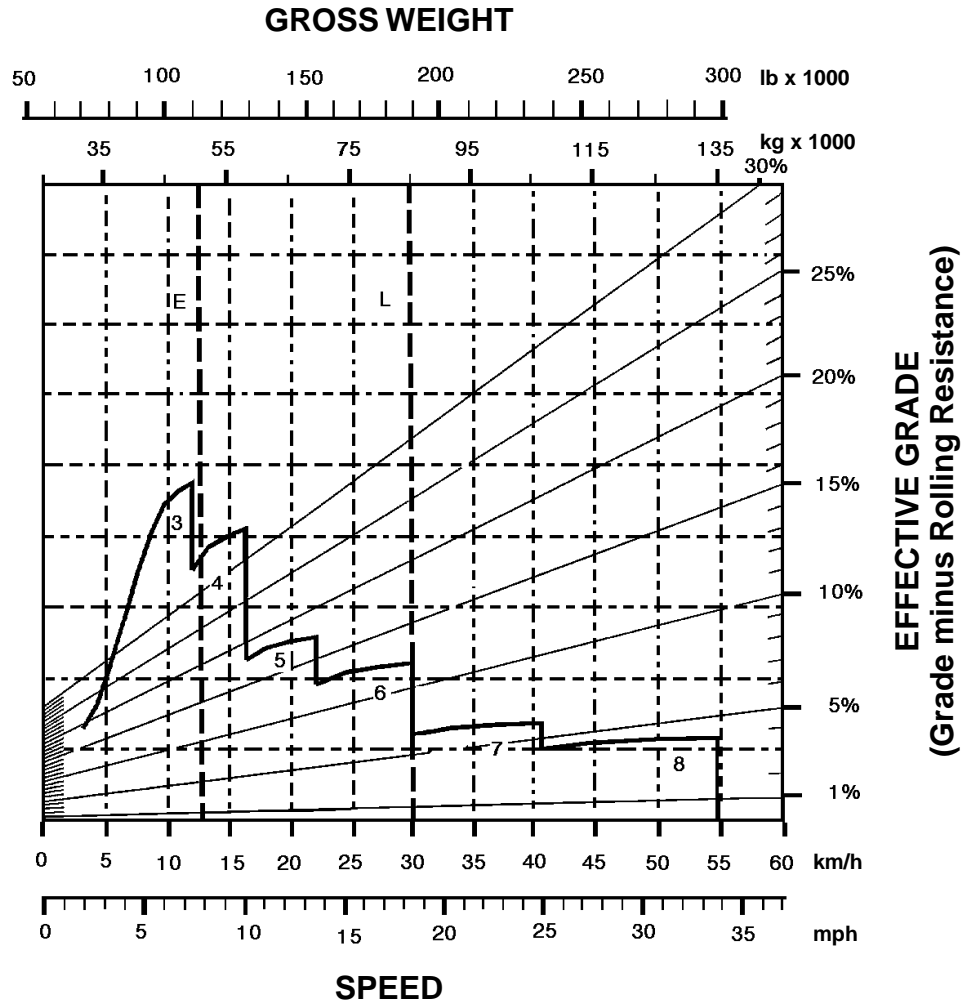

KEY

- 3 — 3rd Gear Direct Drive
- 4 — 4th Gear Direct Drive
- 5 — 5th Gear Direct Drive
- 6 — 6th Gear Direct Drive
- 7 — 7th Gear Direct Drive
- 8 — 8th Gear Direct Drive

KEY

- E — Empty 51 000 kg (112,320 lb)
- L — Loaded 85 020 kg (187,320 lb)

LOADED

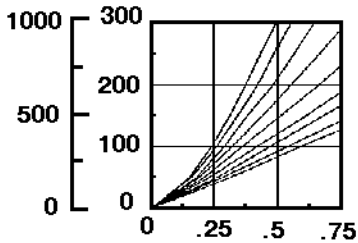
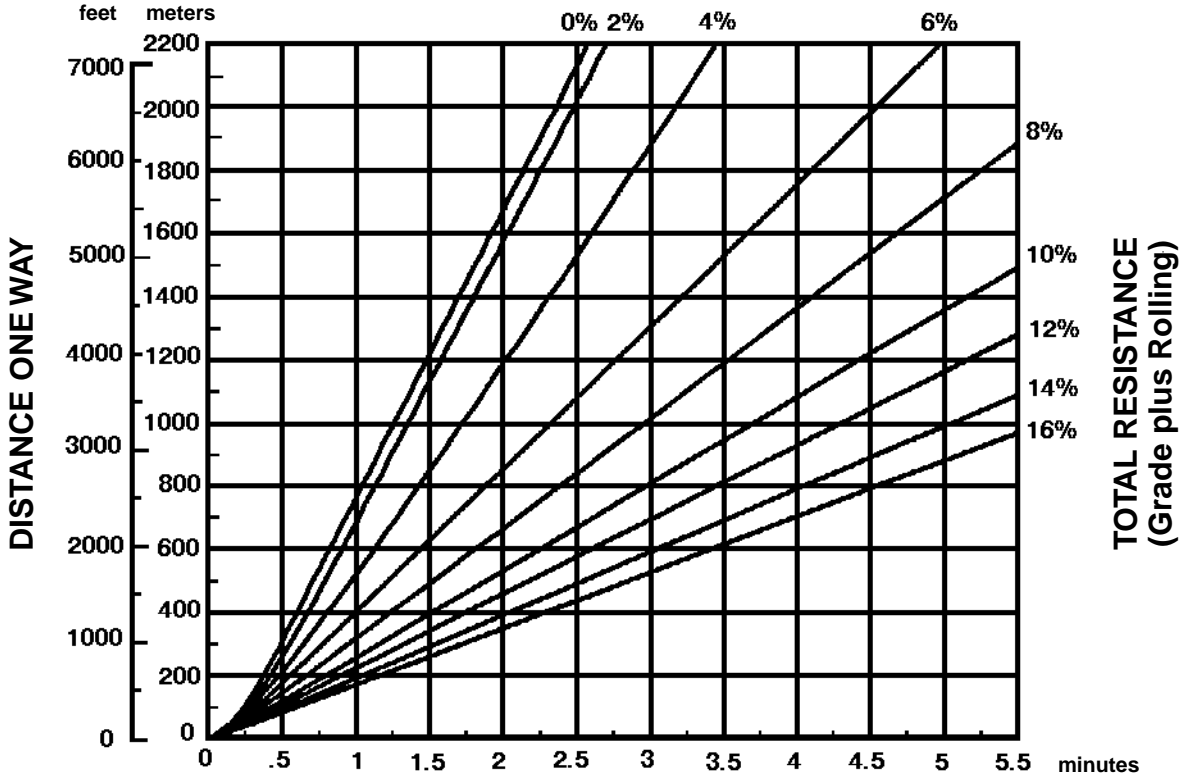

TIME

Empty weight: 51 000 kg (112,320 lb)
 Payload: 34 020 kg (75,000 lb)

Wheel Tractor-Scrapers

637E Series II Travel Time — Empty

- 37.25R35 Tires
- Standard and Push-Pull

EMPTY

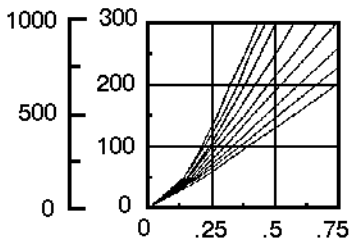
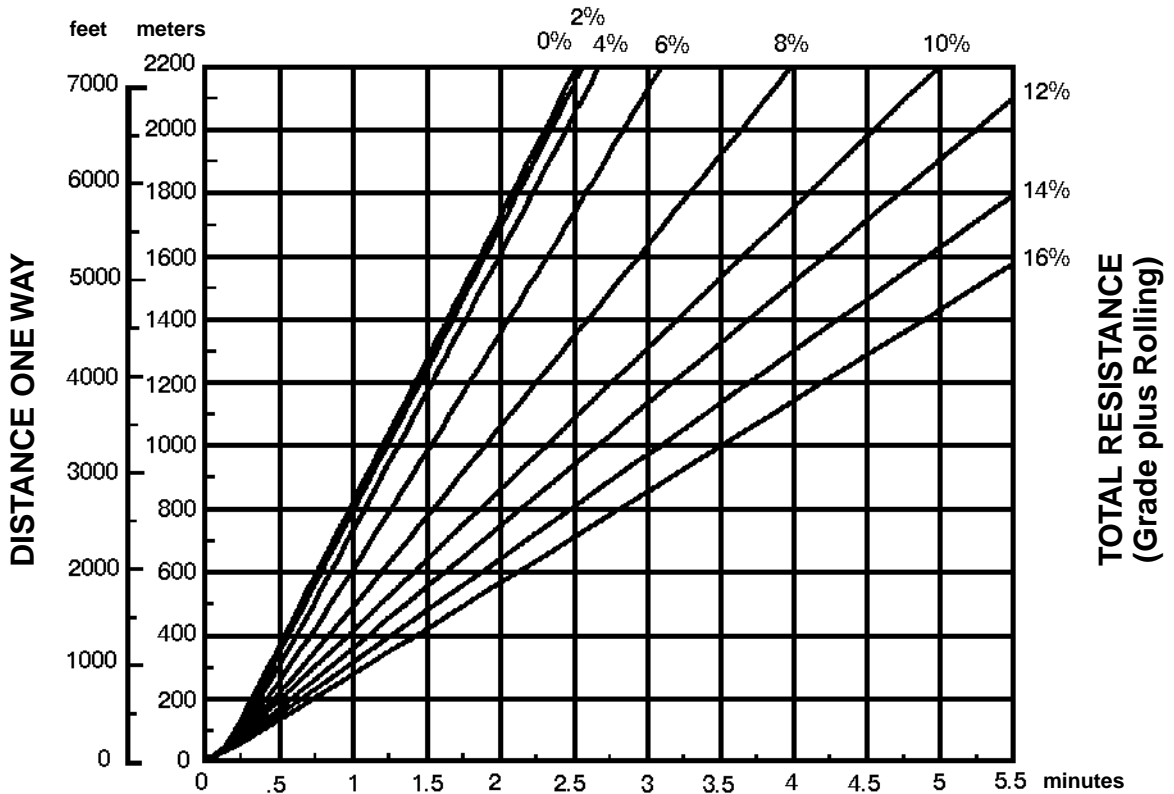

Empty weight: 51 000 kg (112,320 lb)

LOADED

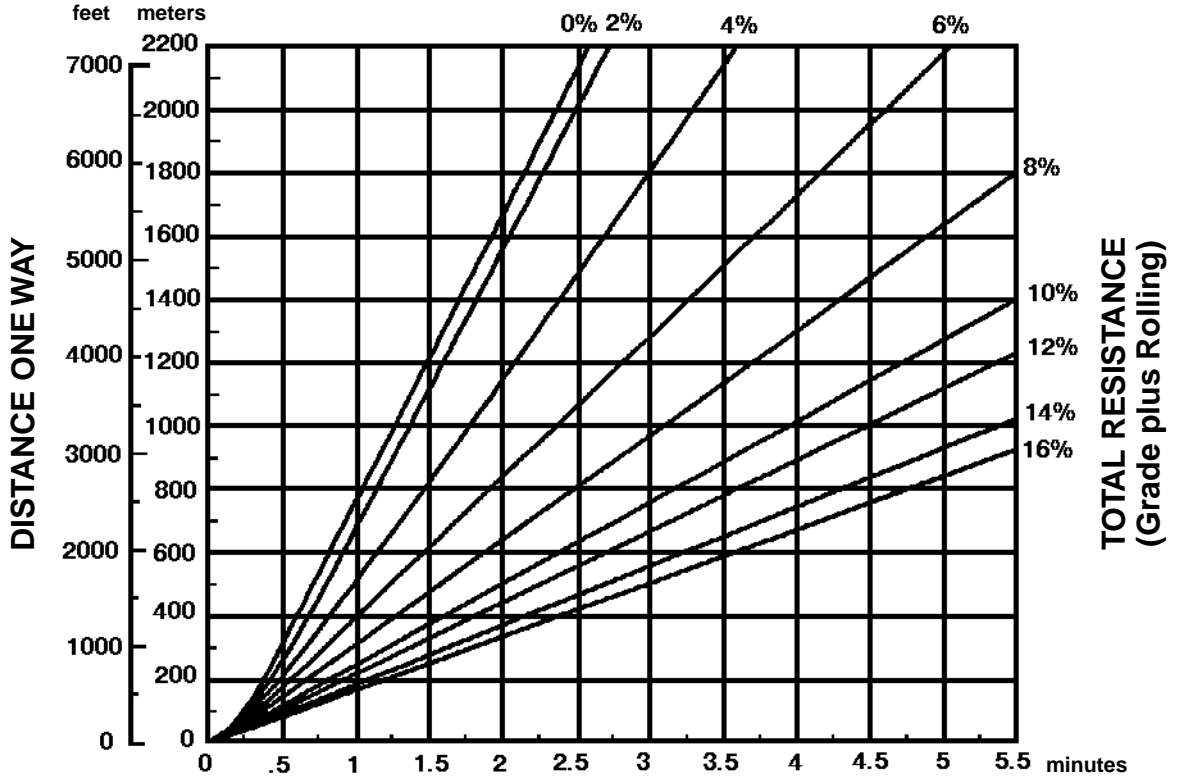

DISTANCE ONE WAY

**TOTAL RESISTANCE
(Grade plus Rolling)**

TIME

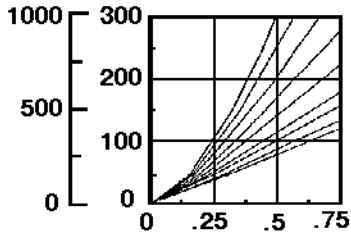

Empty weight: 54 540 kg (120,235 lb)
 Payload: 34 020 kg (75,000 lb)

EMPTY

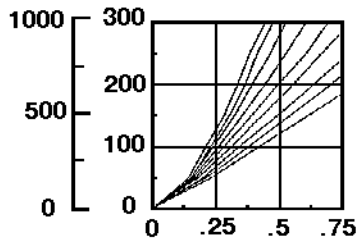
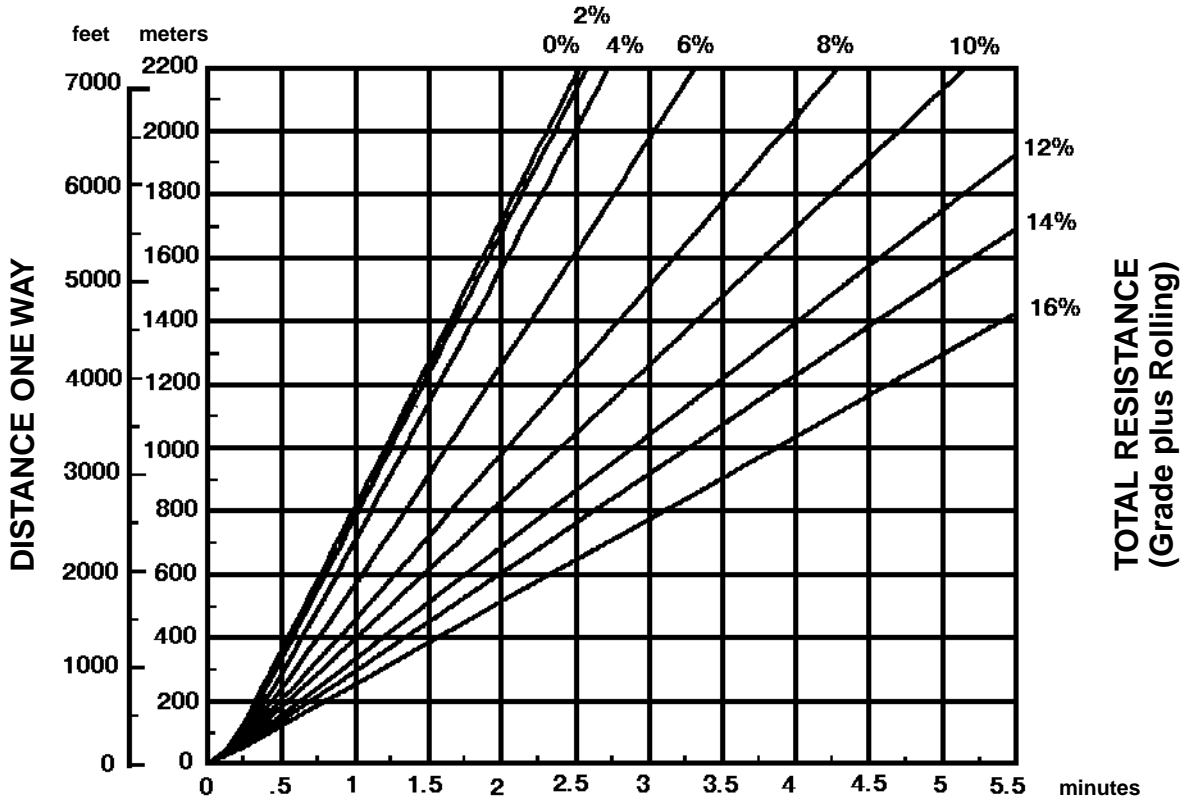

TIME

Empty weight: 54 540 kg (120,235 lb)

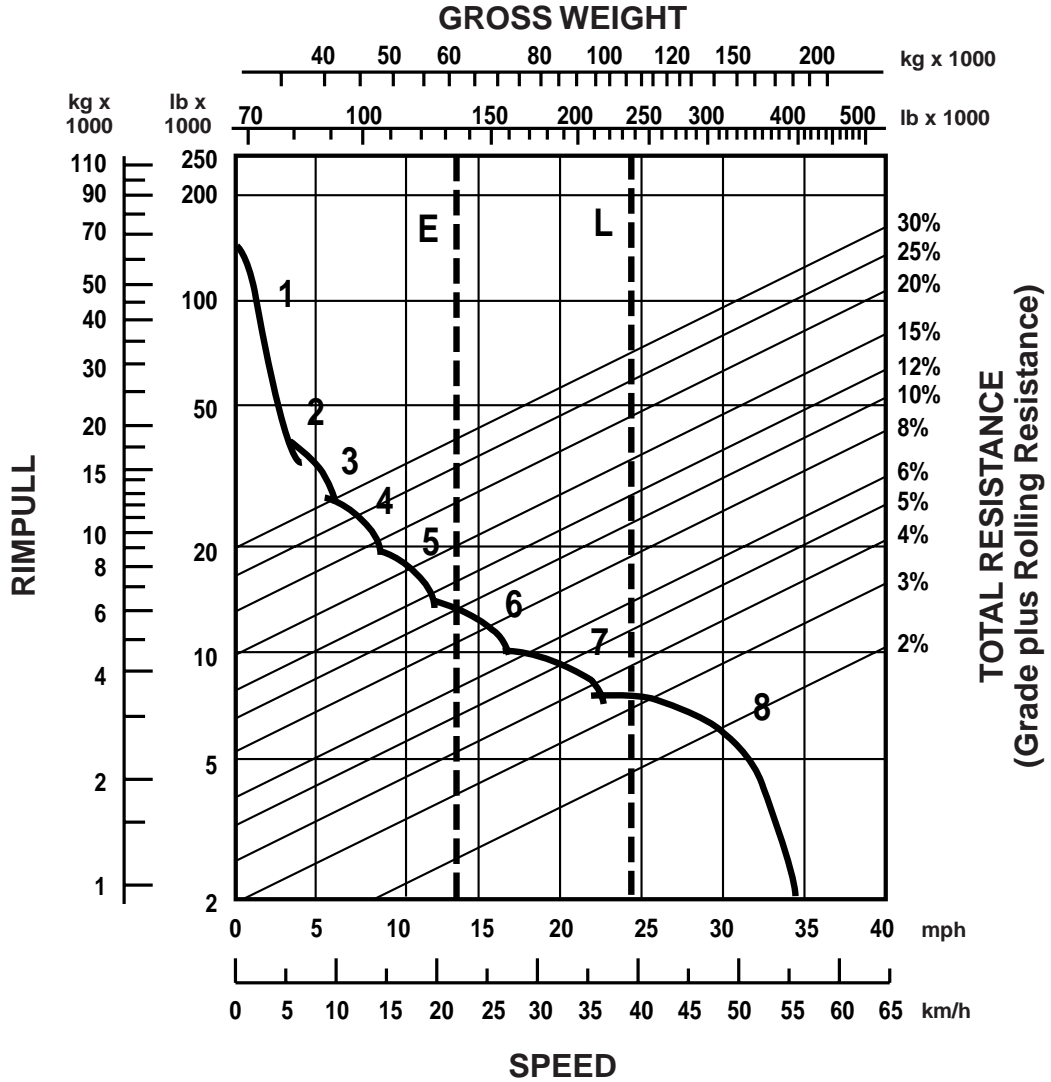

KEY

- 1 — 1st Gear Torque Converter Drive
- 2 — 2nd Gear Torque Converter Drive
- 3 — 3rd Gear Direct Drive
- 4 — 4th Gear Direct Drive
- 5 — 5th Gear Direct Drive
- 6 — 6th Gear Direct Drive
- 7 — 7th Gear Direct Drive
- 8 — 8th Gear Direct Drive

KEY

- E — Empty 61 120 kg (134,760 lb)
- L — Loaded 108 295 kg (238,760 lb)

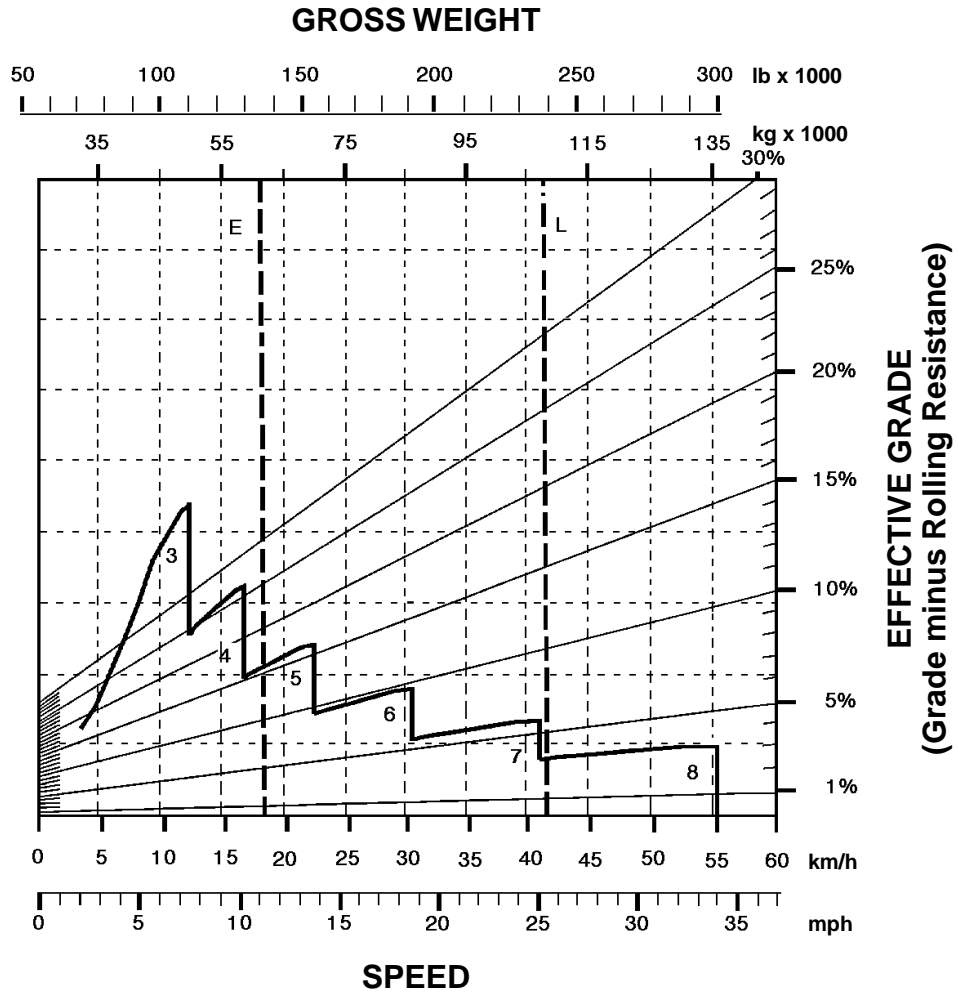

KEY

- 3 — 3rd Gear Direct Drive
- 4 — 4th Gear Direct Drive
- 5 — 5th Gear Direct Drive
- 6 — 6th Gear Direct Drive
- 7 — 7th Gear Direct Drive
- 8 — 8th Gear Direct Drive

KEY

- E — Empty 61 120 kg (134,760 lb)
- L — Loaded 108 295 kg (238,760 lb)

LOADED

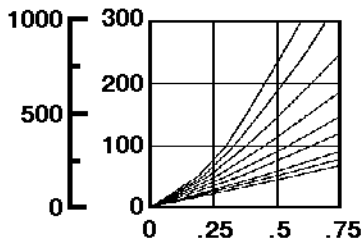
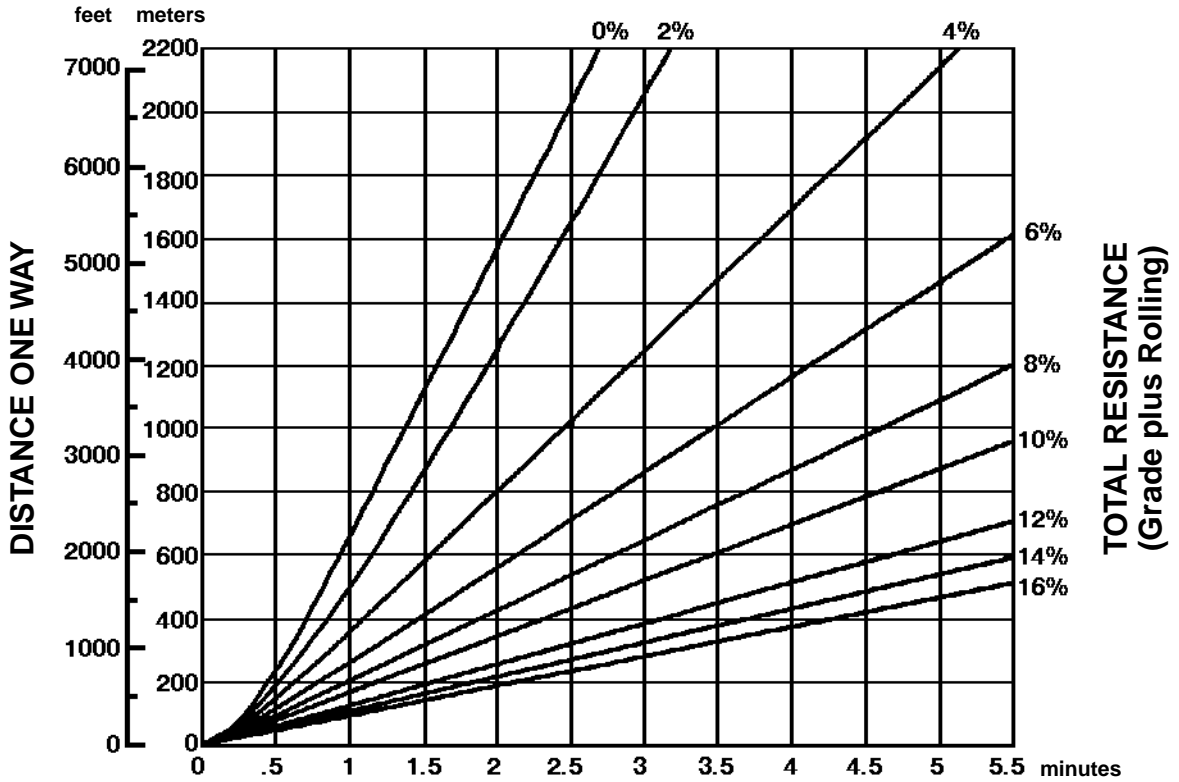

TIME

Empty weight: 66 575 kg (146,770 lb)
 Payload: 47 175 kg (104,000 lb)

EMPTY

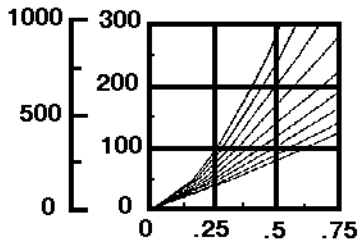
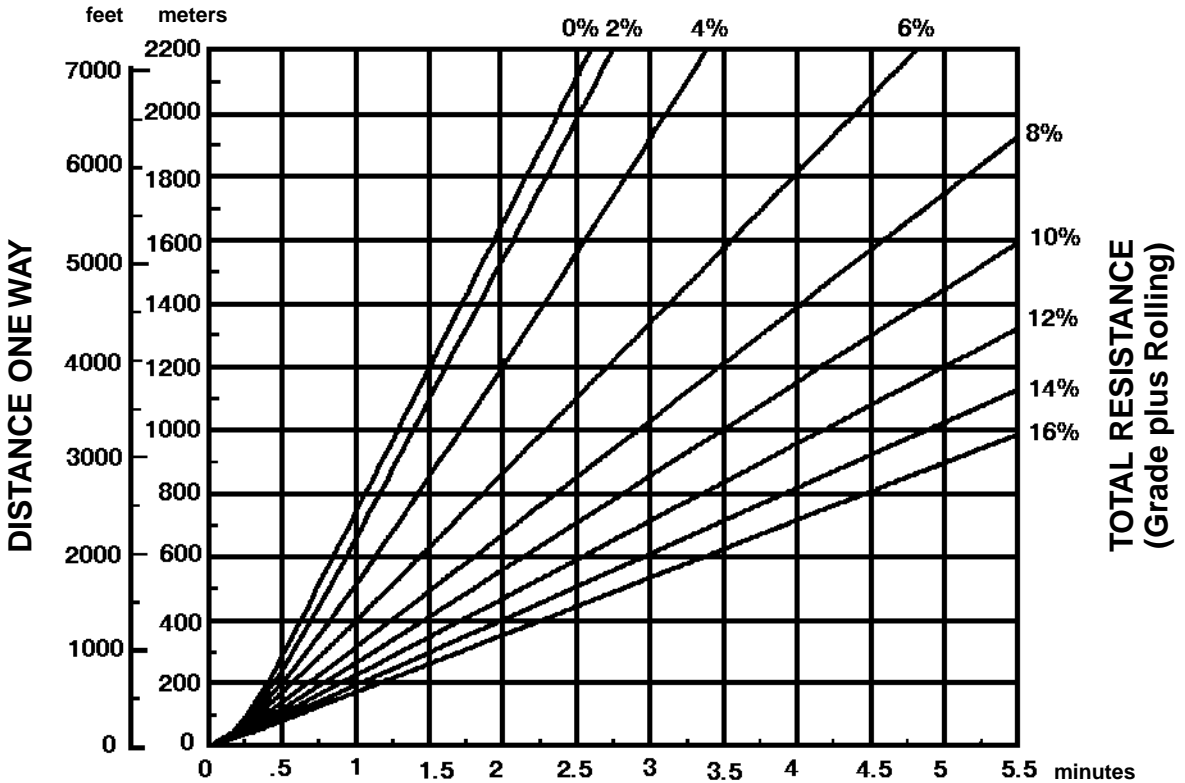

TIME

Empty weight: 66 575 kg (146,770 lb)

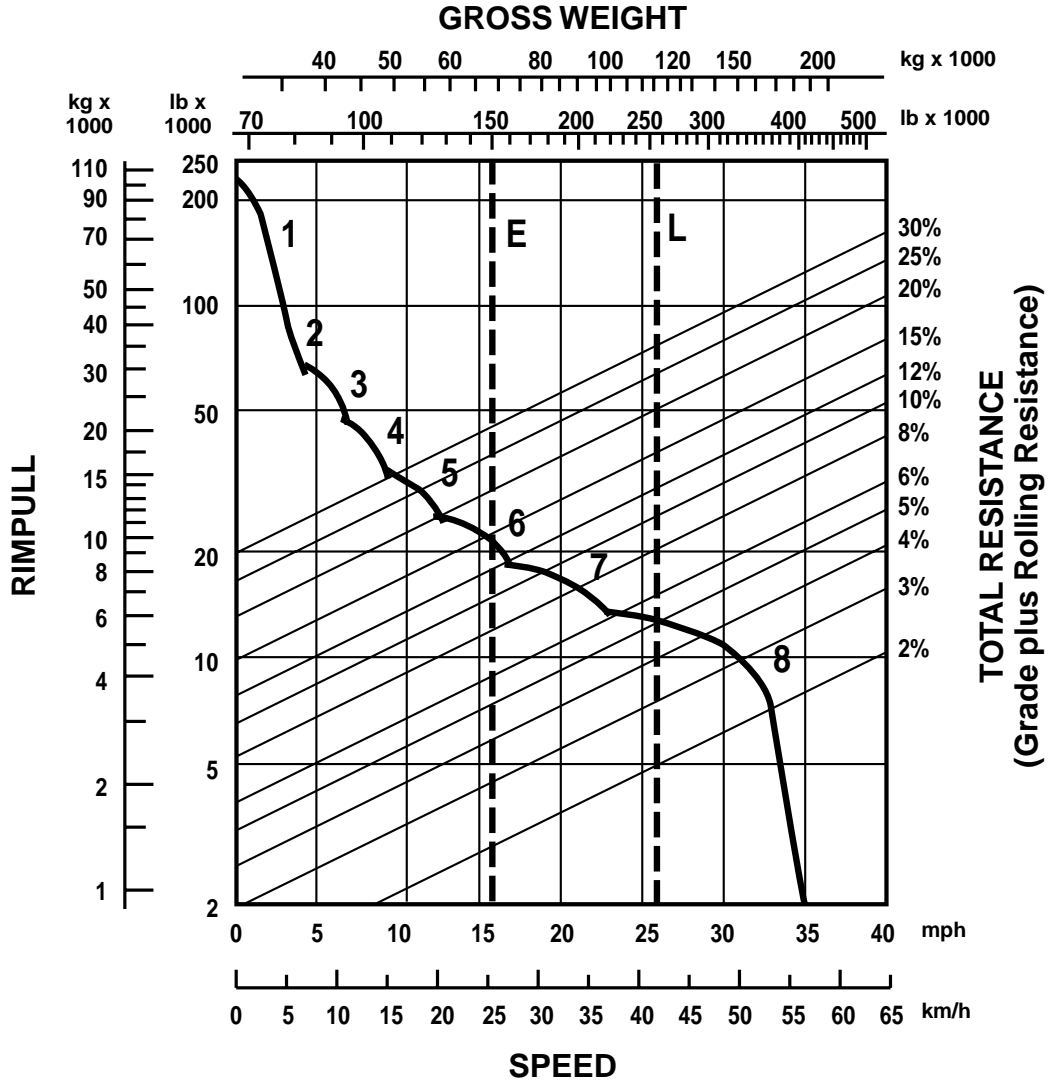

KEY

- 1 — 1st Gear Torque Converter Drive
- 2 — 2nd Gear Torque Converter Drive
- 3 — 3rd Gear Direct Drive
- 4 — 4th Gear Direct Drive
- 5 — 5th Gear Direct Drive
- 6 — 6th Gear Direct Drive
- 7 — 7th Gear Direct Drive
- 8 — 8th Gear Direct Drive

KEY

- E — Empty 69 080 kg (152,290 lb)
- L — Loaded 116 250 kg (256,290 lb)

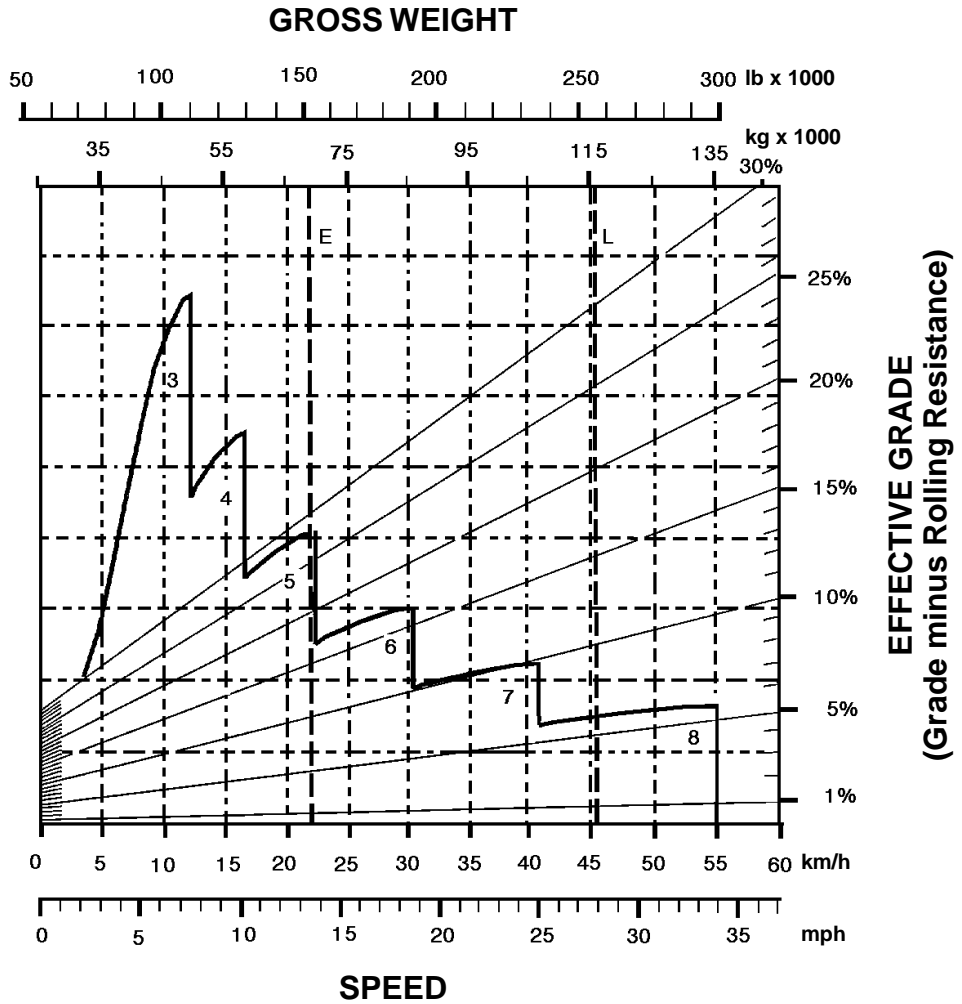

KEY

- 3 — 3rd Gear Direct Drive
- 4 — 4th Gear Direct Drive
- 5 — 5th Gear Direct Drive
- 6 — 6th Gear Direct Drive
- 7 — 7th Gear Direct Drive
- 8 — 8th Gear Direct Drive

KEY

- E — Empty 70 670 kg (155,650 lb)
- L — Loaded 117 935 kg (259,650 lb)

657E Travel Time — Loaded
 • 40.5/75R39 Tires
 • Standard and Push-Pull

Wheel Tractor-Scrapers

LOADED

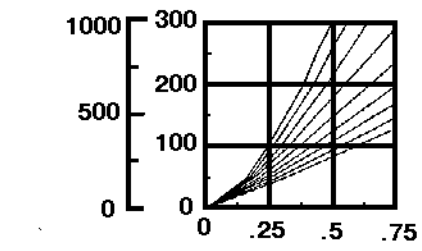
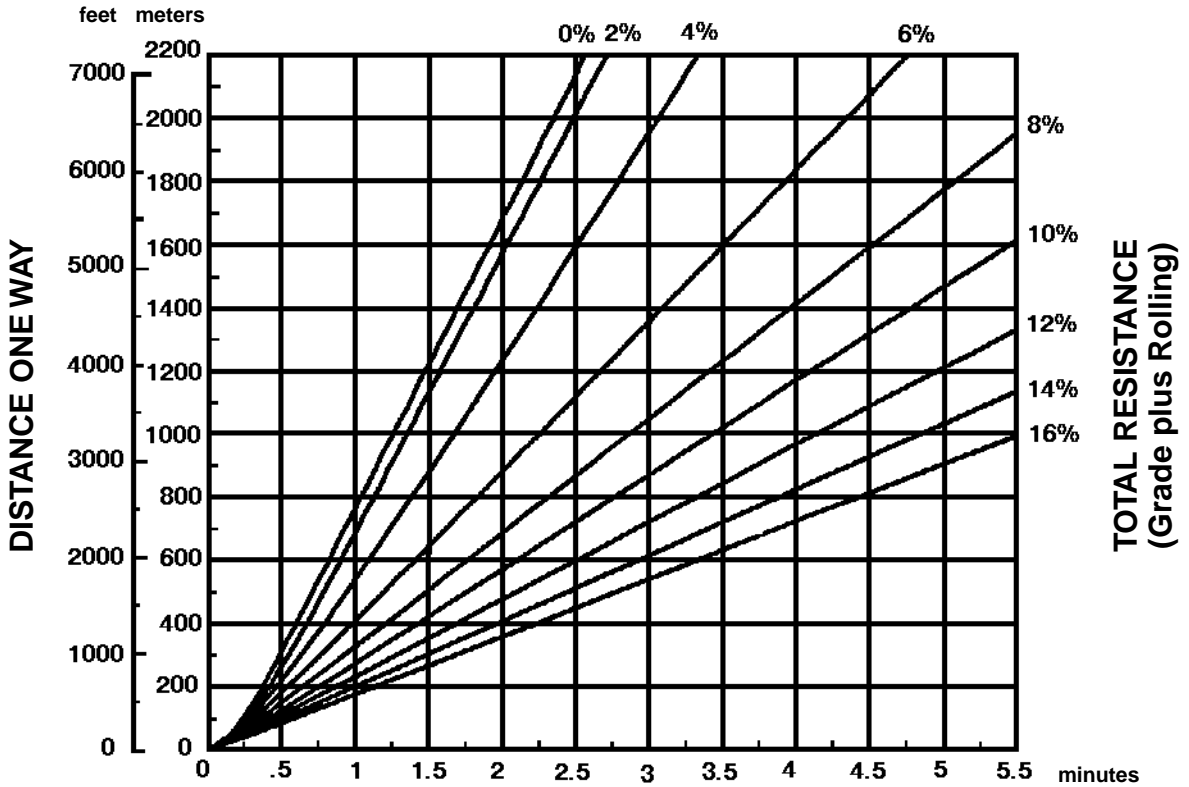

Empty weight: 70 670 kg (155,650 lb)
 Payload: 47 175 kg (104,000 lb)

Wheel Tractor-Scrapers

657E Travel Time — Empty

- 40.5/75R39 Tires
- Standard and Push-Pull

EMPTY

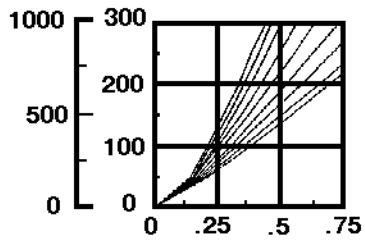
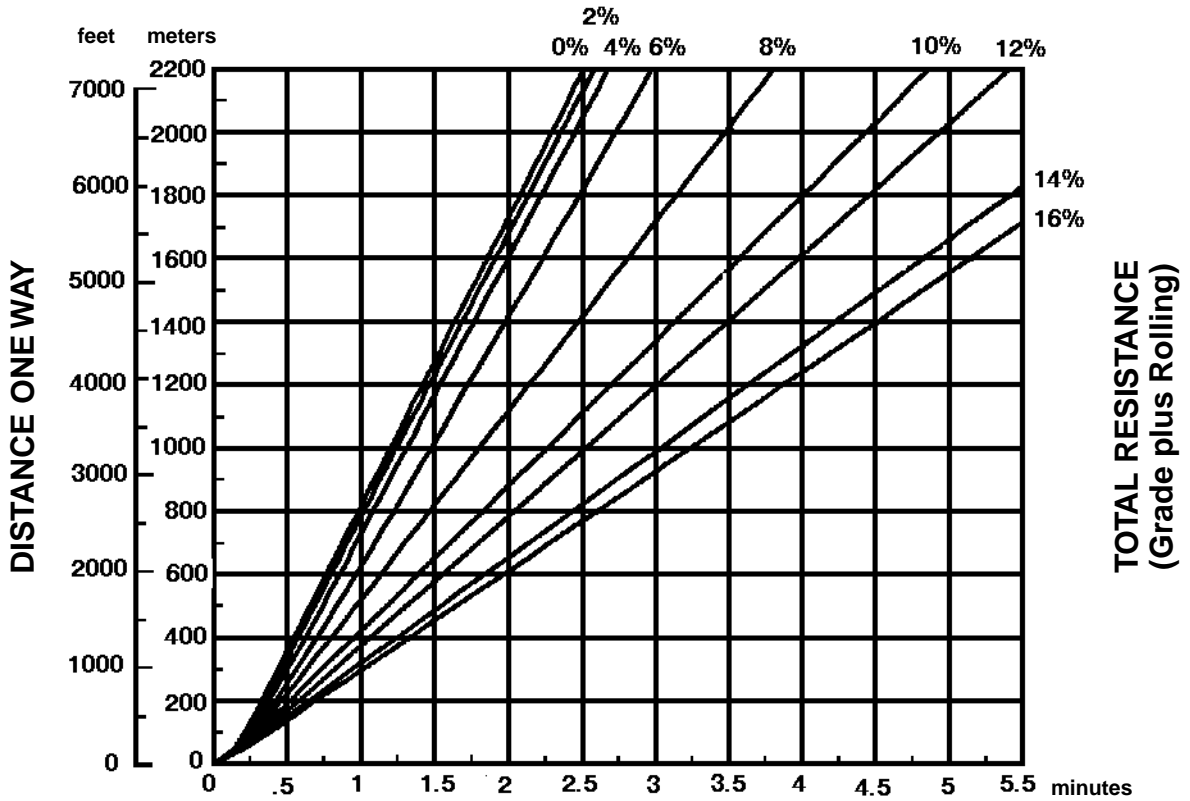

TIME

Empty weight: 70 670 kg (155,650 lb)

LOADED

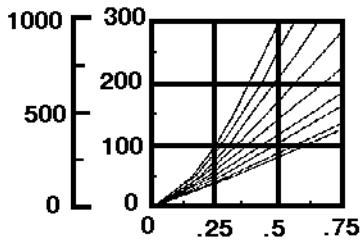
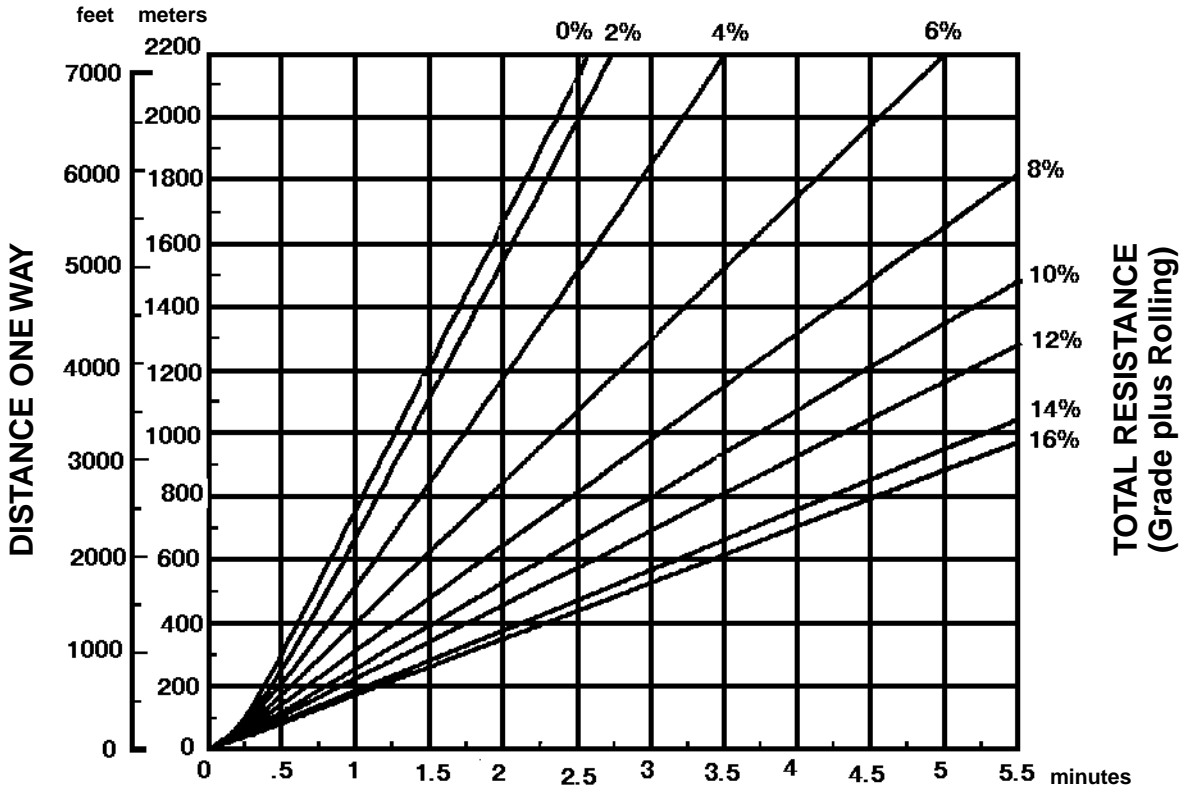

Empty weight: 75 875 kg (167,270 lb)
 Payload: 47 175 kg (104,000 lb)

EMPTY

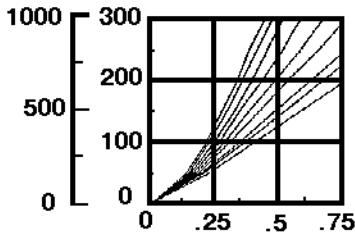
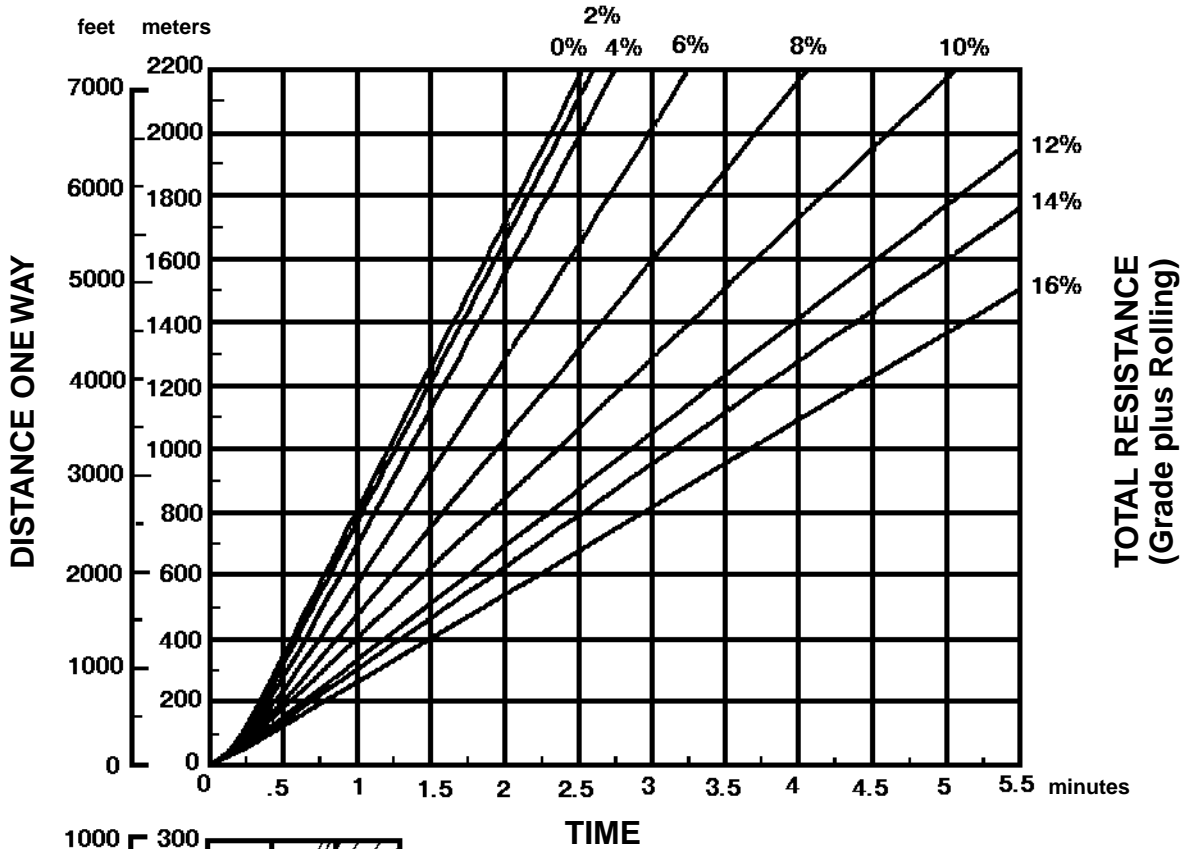

Empty weight: 75 875 kg (167,270 lb)

DISTANCE vs. PRODUCTION

CONDITIONS: Flat haul. Percentages shown are rolling resistance only. 100% efficiency (60 min hour).

- Material: 1780 kg/m³ (3000 lb/yd³).
- Payload: 11 975 kg, 6.7 Bm³ (26,400 lb, 8.8 BCY).
- Empty weight: 15 264 kg (33,650 lb).
- Fixed time: 1.6 min.

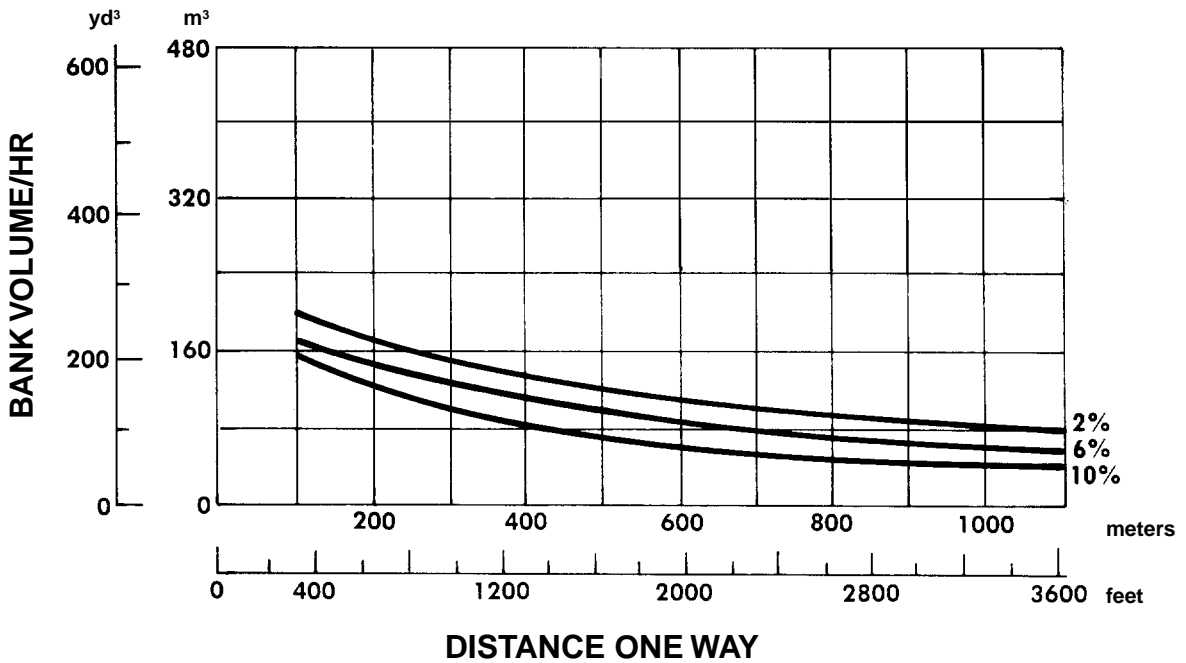

DISTANCE vs. PRODUCTION

CONDITIONS: Flat haul. Percentages shown are rolling resistance only.

100% efficiency (60 min hour).

- Material: 1780 kg/m³ (3000 lb/yd³).
- Payload: 18 506 kg, 10.4 Bm³ (40,800 lb, 13.6 BCY).
- Empty weight: 44 113 kg (97,250 lb).
- Fixed time: 1.6 min.

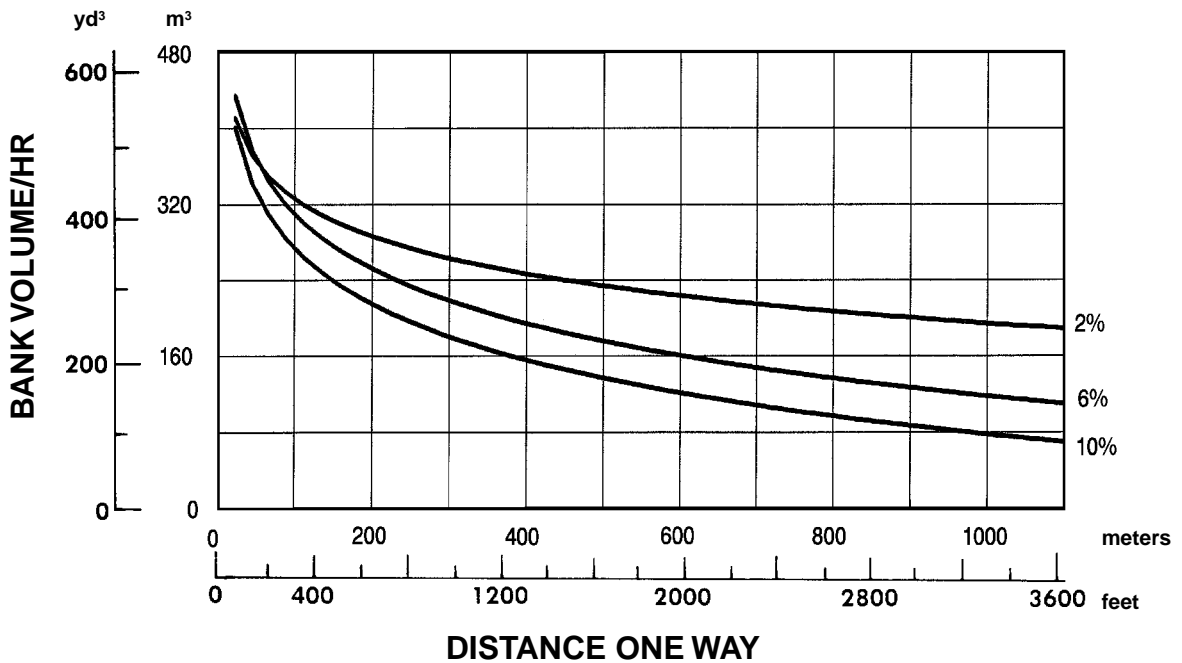

DISTANCE vs. PRODUCTION

CONDITIONS: Flat haul. Percentages shown are rolling resistance only. 100% efficiency (60 min hour).

- Material: 1780 kg/m³ (3000 lb/yd³).
- Payload: 21 770 kg, 12.2 Bm³ (48,000 lb, 16 BCY).
- Empty weight: 32 070 kg (70,700 lb).
- Fixed time: 1.4 min.

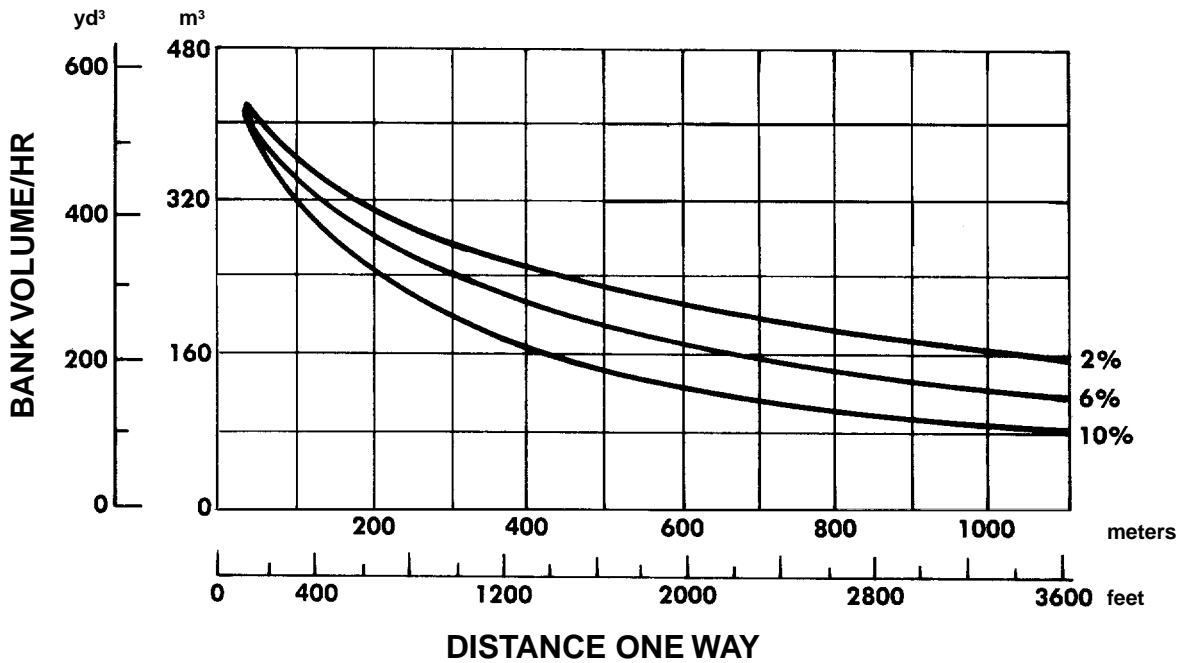

Wheel Tractor-Scrapers

623F Bm³ (BCY)/hr
● 33.25R29 Tires

DISTANCE vs. PRODUCTION

CONDITIONS: Flat haul. Percentages shown are rolling resistance only.
100% efficiency (60 min hour).

- Material: 1780 kg/m³ (3000 lb/yd³).
- Payload: 24 950 kg, 12.2 Bm³ (55,000 lb, 16 BCY).
- Empty weight: 35 290 kg (77,800 lb).
- Fixed time: 1.6 min.

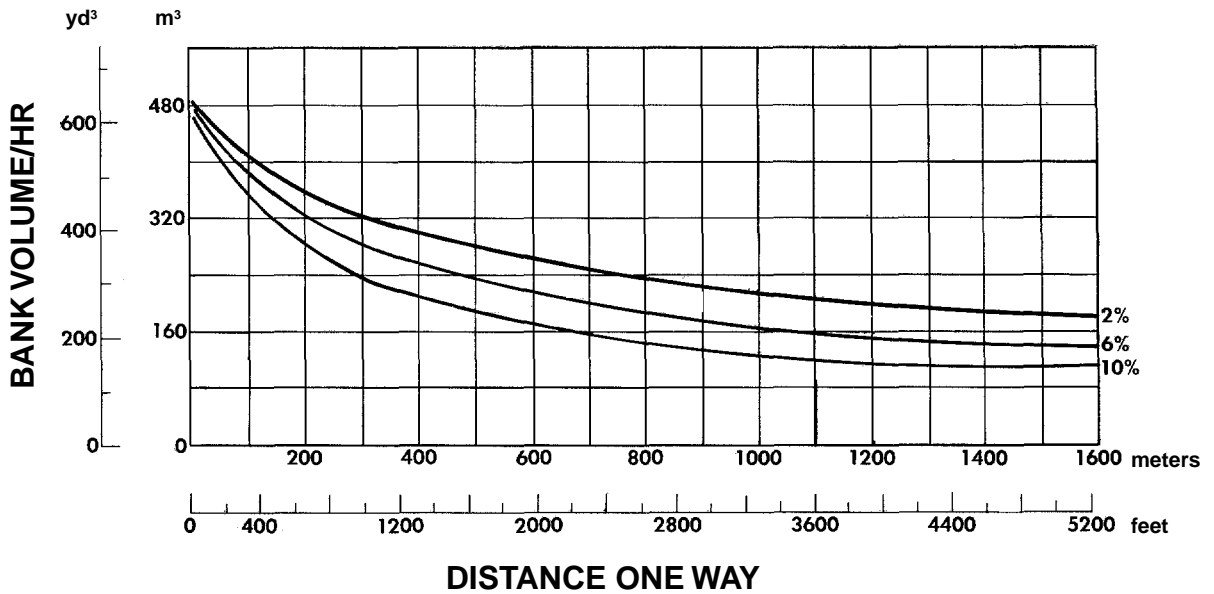

DISTANCE vs. PRODUCTION

CONDITIONS: Flat haul. Percentages shown are rolling resistance only. 100% efficiency (60 min hour).

- Material: 1780 kg/m³ (3000 lb/yd³).
- Payload: 21 770 kg, 12.2 Bm³ (48,000 lb, 16 BCY).
- Empty weight: 37 060 kg (81,640 lb).
- Fixed time: 1.2 min.

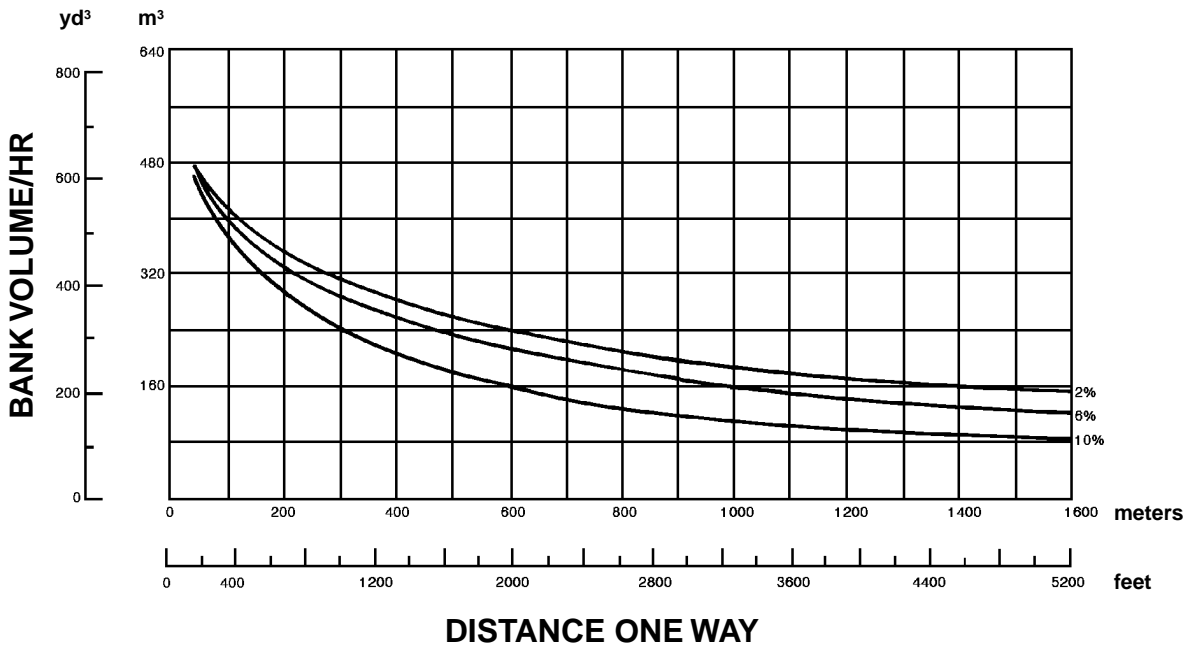

DISTANCE vs. PRODUCTION

CONDITIONS: Flat haul. Percentages shown are rolling resistance only. 100% efficiency (60 min hour).

- Material: 1780 kg/m³ (3000 lb/yd³).
- Payload: 21 770 kg, 12.2 Bm³ (48,000 lb, 16 BCY).
- Empty weight: 38 103 kg (84,000 lb).
- Fixed time: 1.5 min. (includes loading both units and transfer time).

NOTE: Production estimates apply to one unit. Double these figures for a push-pull pair.

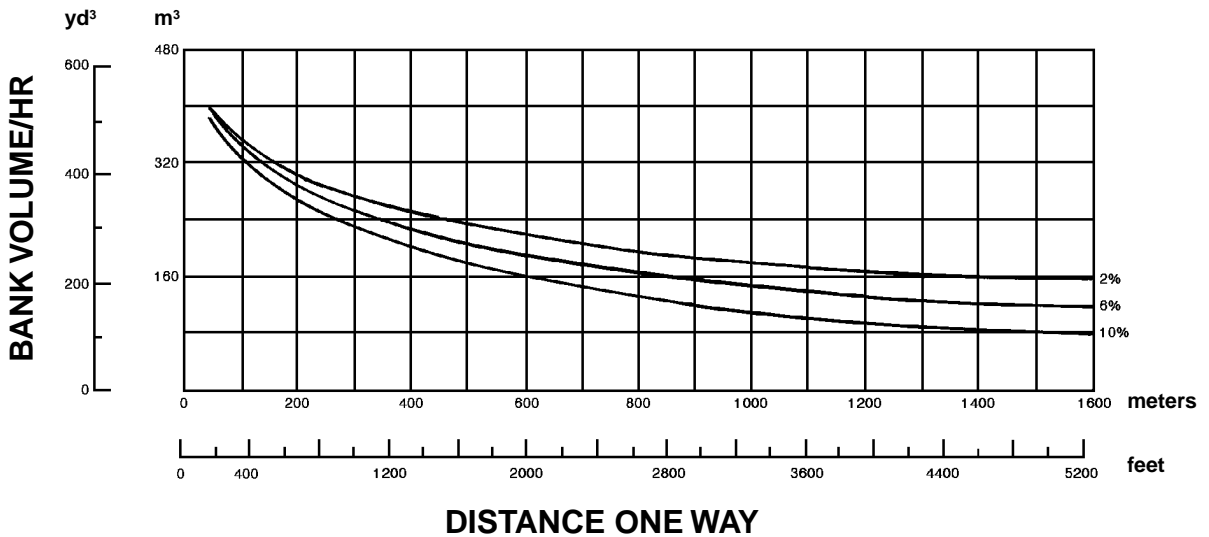

DISTANCE vs. PRODUCTION

CONDITIONS: Flat haul. Percentages shown are rolling resistance only. 100% efficiency (60 min hour).

- Material: 1780 kg/m³ (3000 lb/yd³).
- Payload: 34 020 kg, 19.1 Bm³ (75,000 lb, 25 BCY).
- Empty weight: 45 400 kg (100,000 lb).
- Fixed time: 1.3 min.

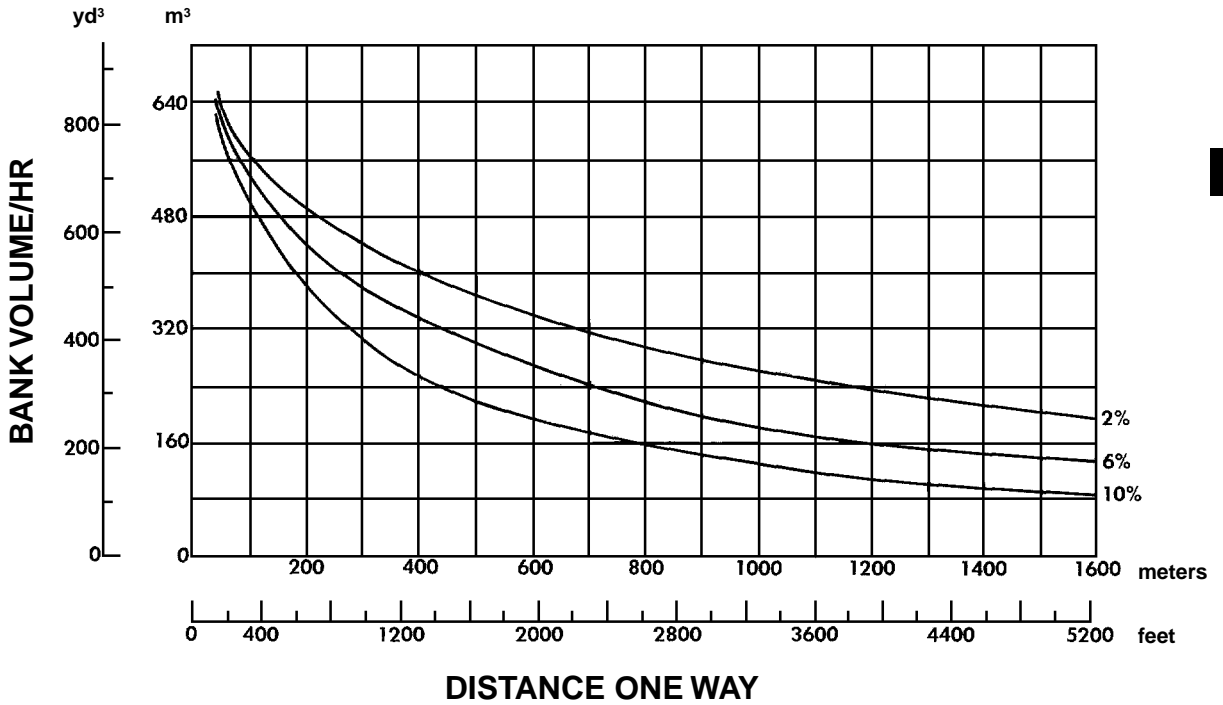

DISTANCE vs. PRODUCTION

CONDITIONS: Flat haul. Percentages shown are rolling resistance only. 100% efficiency (60 min hour).

- Material: 1780 kg/m³ (3000 lb/yd³).
- Payload: 34 020 kg, 19.1 Bm³ (75,000 lb, 25 BCY).
- Empty weight: 50 990 kg (112,320 lb).
- Fixed time: 1.1 min.

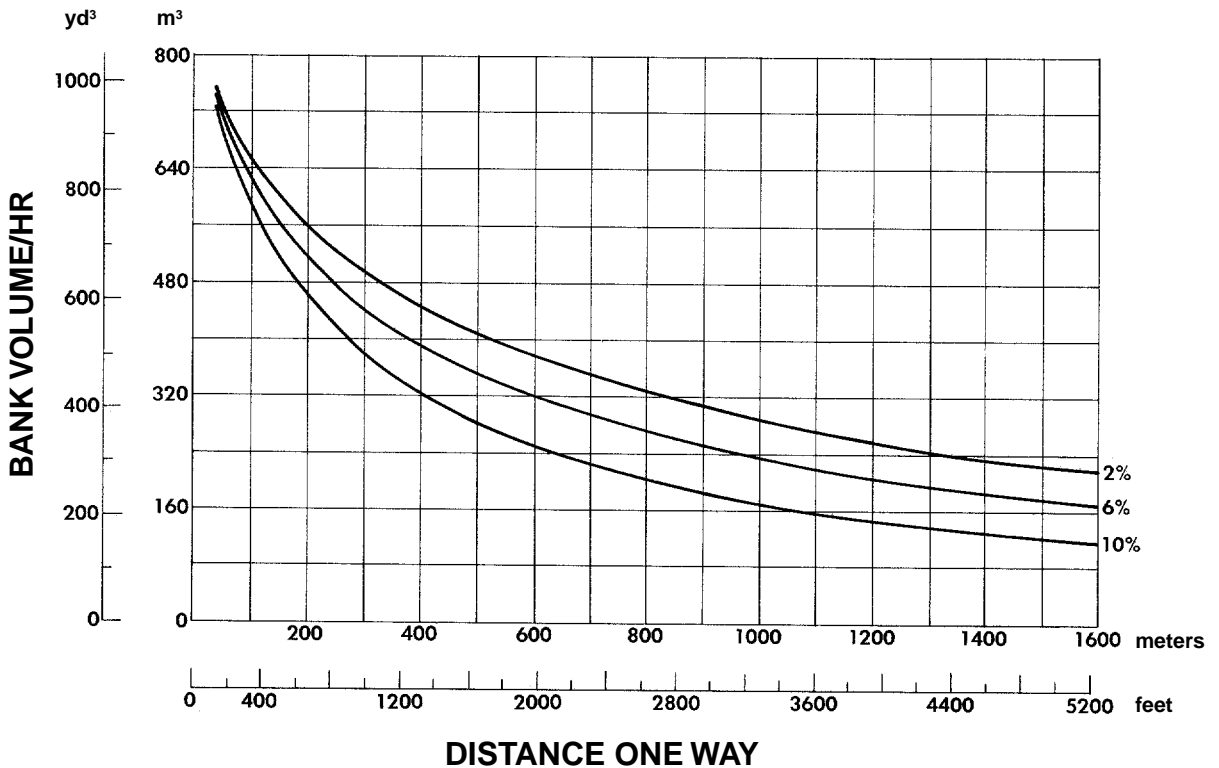

DISTANCE vs. PRODUCTION

CONDITIONS: Flat haul. Percentages shown are rolling resistance only. 100% efficiency (60 min hour).

- Material: 1780 kg/m³ (3000 lb/yd³).
- Payload: 34 020 kg, 19.1 Bm³ (75,000 lb, 25 BCY).
- Empty weight: 52 385 kg (115,490 lb).
- Fixed time: 1.6 min. (includes loading both units and transfer time).

NOTE: Production estimates apply to one unit. Double these figures for a push-pull pair.

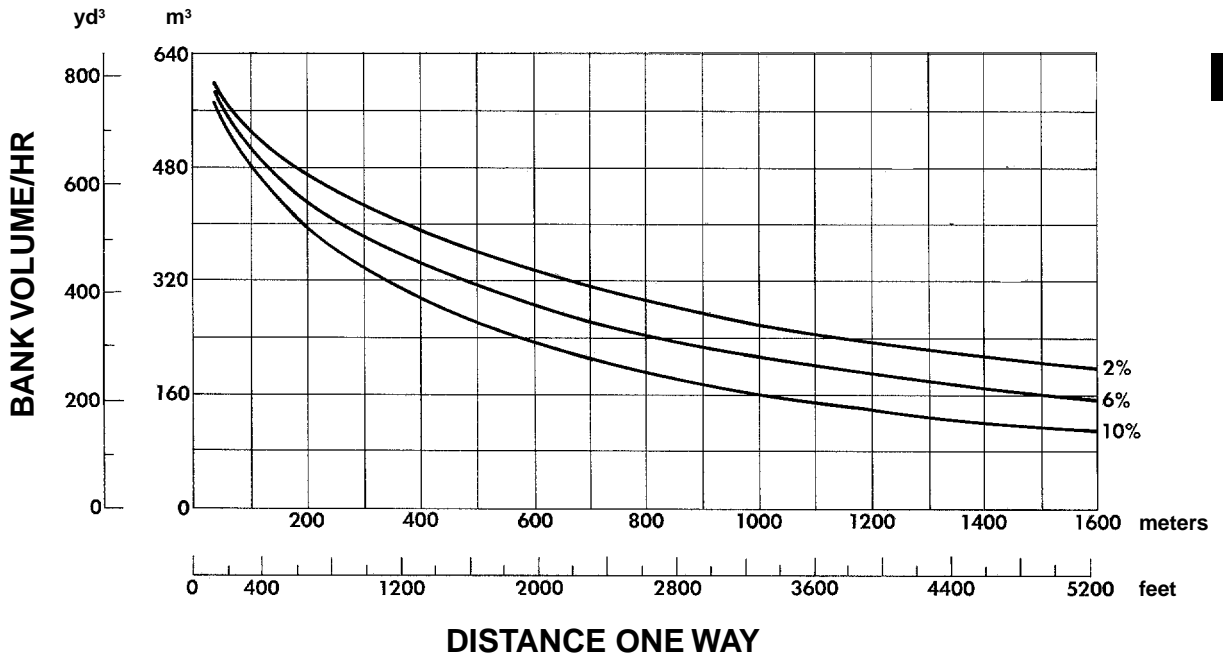

Wheel Tractor-Scrapers

651E Bm³ (BCY)/hr
● 40.5/75R39 Tires

DISTANCE vs. PRODUCTION

CONDITIONS: Flat haul. Percentages shown are rolling resistance only.

100% efficiency (60 min hour).

- Material: 1780 kg/m³ (3000 lb/yd³).
- Payload: 47 200 kg, 26.5 Bm³ (104,056 lb, 34.6 BCY).
- Empty weight: 61 120 kg (134,760 lb).
- Fixed time: 1.3 min.

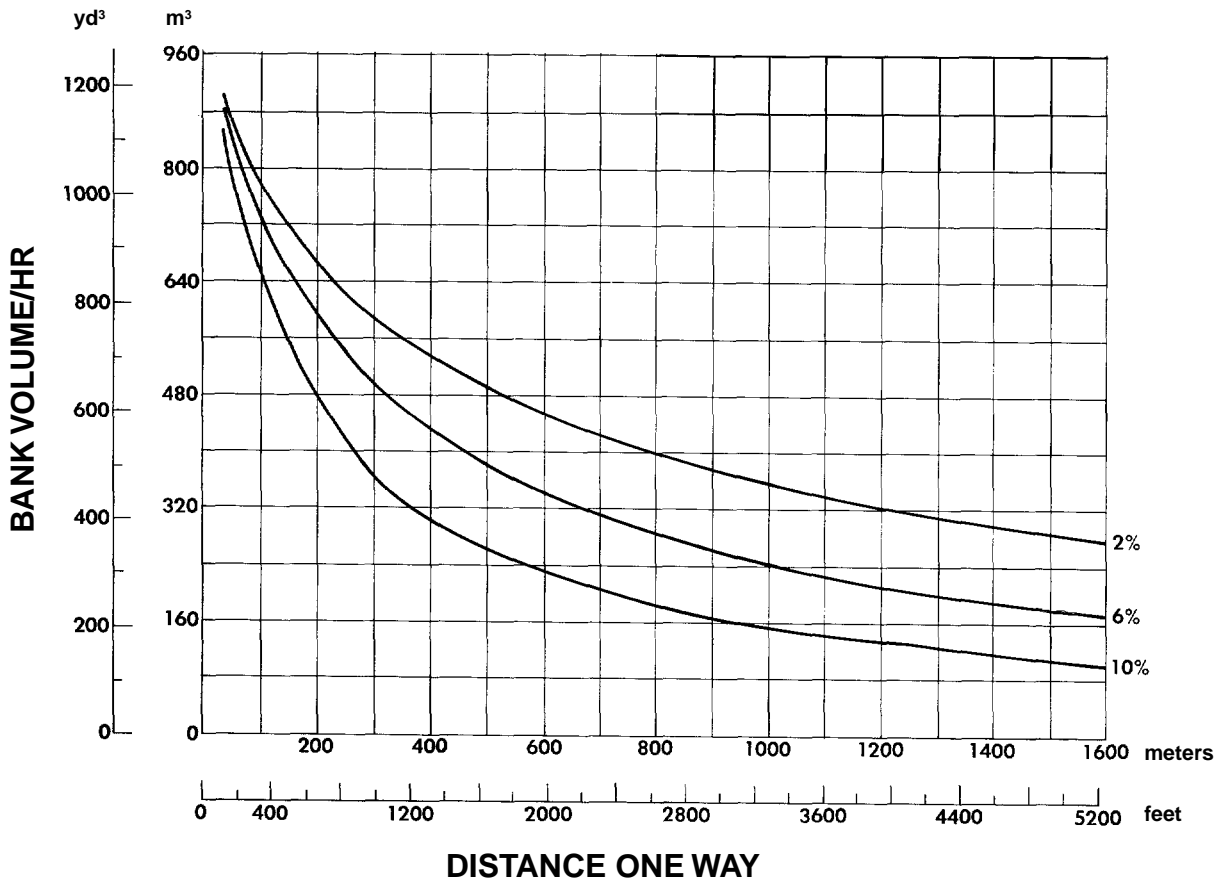

DISTANCE vs. PRODUCTION

CONDITIONS: Flat haul. Percentages shown are rolling resistance only. 100% efficiency (60 min hour).

- Material: 1780 kg/m³ (3000 lb/yd³).
- Payload: 47 200 kg, 26.5 Bm³ (104,000 lb, 34.6 BCY).
- Empty weight: 70 670 kg (155,650 lb).
- Fixed time: 1 min.

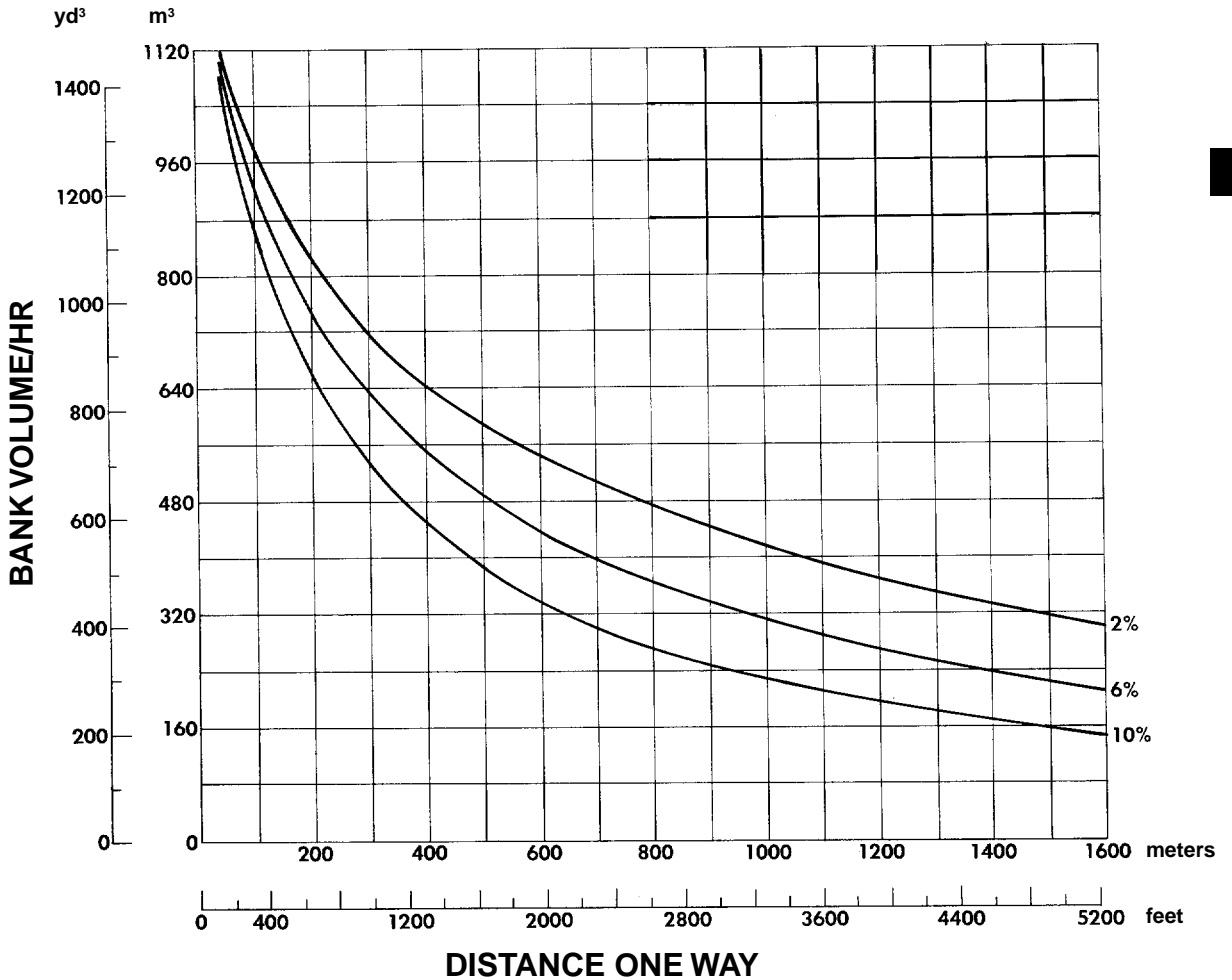

DISTANCE vs. PRODUCTION

CONDITIONS: Flat haul. Percentages shown are rolling resistance only. 100% efficiency (60 min hour).

- Material: 1780 kg/m³ (3000 lb/yd³).
- Payload: 47 200 kg, 26.5 Bm³ (104,000 lb, 34.6 BCY).
- Empty weight: 72 640 kg (160,140 lb).
- Fixed time: 1.7 min. (includes loading both units and transfer time).

NOTE: Production estimates apply to one unit. Double these figures for a push-pull pair.

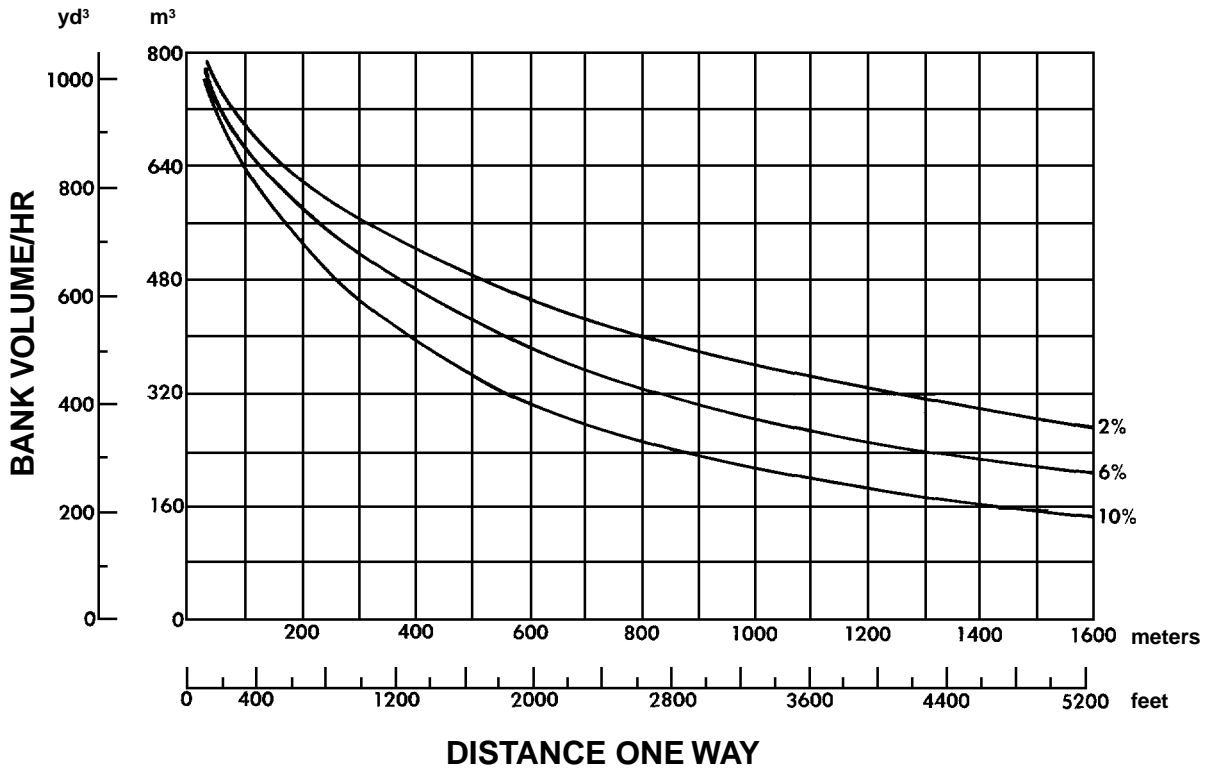

- Bm³ (BCY)/hr
- All Models
- 100% Efficiency

HOURLY PRODUCTION vs. CYCLE TIME

VEHICLE CAPACITY:

- 613C Series II @ 6.7 Bm³/trip (8.8 BCY)
- 615C Series II @ 9.7 Bm³/trip (12.8 BCY)
- 621F, 623F, 627F @ 12.2 Bm³/trip (16 BCY)
- 631E Series II, 633E Series II, 637E Series II @ 19.1 Bm³/trip (25 BCY)
- 651E, 657E @ 26.5 Bm³/trip (34.6 BCY)

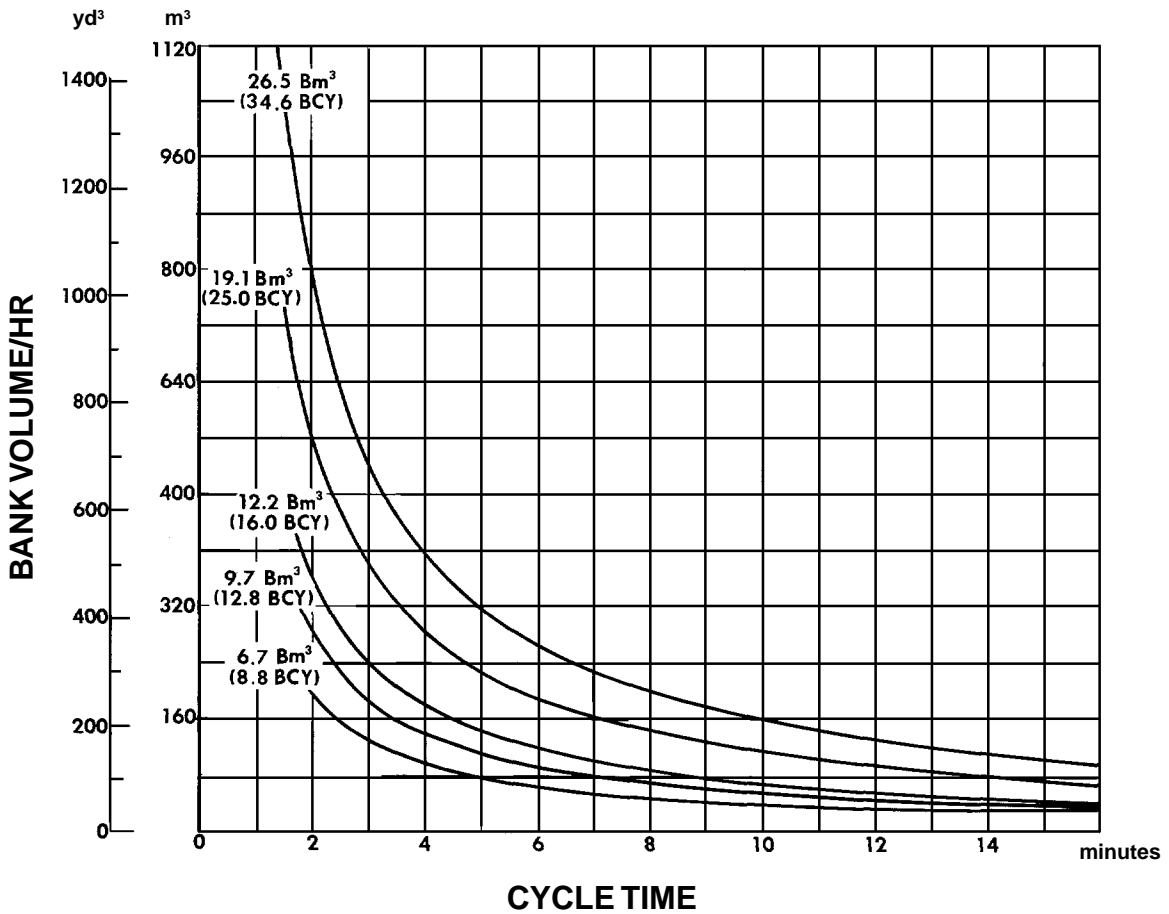

CONSTRUCTION & MINING TRUCKS CONSTRUCTION & MINING TRACTORS

CONTENTS

Features	9-1
Truck Specifications	9-2
Tractor Specifications	9-4
Tire Specifications	9-7
Use of Brake Performance curves	9-8
Fixed times for hauling units	9-8
Mechanical Power Train Efficiencies	9-9
Curves:	
769D Rimpull-Speed-Gradeability, Brake Performance, Travel Time	9-10
771D Rimpull-Speed-Gradeability, Brake Performance, Travel Time	9-14
773D Rimpull-Speed-Gradeability, Brake Performance, Travel Time	9-18
775D Rimpull-Speed-Gradeability, Brake Performance, Travel Time	9-23
776D, 777D Rimpull-Speed-Gradeability, Brake Performance, Travel Time	9-27
784C, 785C Rimpull-Speed-Gradeability, Brake Performance, Travel Time	9-31
789C Rimpull-Speed-Gradeability, Brake Performance, Travel Time	9-36
793C Rimpull-Speed-Gradeability, Brake Performance, Travel Time	9-40

Features:

- **Caterpillar four-stroke-cycle diesels** ... turbo-charged, aftercooled, adjustment-free fuel system (direct injection).
- **Electronically-controlled automatic transmission** ... speed sensing device automatically shifts transmission between 1st and gear selected by operator.
- **Truck Production Management System (TPMS)** utilizes strut pressure sensors and an on-board microprocessor to determine payload weight, cycle segment times, delay times, actual clock time and date of each cycle.
- **Vital Information Management System (VIMS)** Monitors all vital machine functions. Keeps operator informed of current machine operating conditions, helps reduce downtime and allows service personnel easy access to data for fast accurate diagnosis. VIMS includes Production Management System.

- **Electronic Unit Injection (EUI)** in the 776D-793C and **Hydraulic Electronic Unit Injection (HEUI)** on 769D-775D electronically maintains fuel settings, provides automatic altitude and air filter restriction compensation, automatic variable timing, improved diagnostics and increased fuel efficiency.
- **Oil cooled disc brakes** provide retarding, service, parking, and secondary braking in one sealed, fade-resistant, maintenance-free unit. 769D-777D front brakes are caliper disc, can be switched out of the service system when not needed but activate as part of the secondary system. (Front oil-cooled brakes optional on 777D.) 784C-793C front brakes are oil-cooled disc.
- **Automatic Retarder Control (ARC)** electronically controls braking on grade to maintain faster downhill speeds and consistently higher engine speed.
- **Full hydraulic steering**, with front suspension cylinders serving as kingpins.
- **Four independent**, self-contained, oil-pneumatic suspension cylinders absorb loading and road shocks. Wide spacing for stability.
- **Dual slope body** has V-bottom for load balance and retention. Low loading height and center of gravity.
- **Quarry trucks** have single-slope flat floor for smooth, metered dumping into crushers or hoppers. Optional flat floor body available for 769D, 773D.
- **Integral Roll Over Protective Structure (ROPS)** cab standard on all models.
- **Separate hydraulic systems** prevents cross contamination.

Tractor Features:

- **Yoke type hitch** oscillates four ways to reduce frame stresses. Rugged turn stops prevent excessive wagon rotation either direction.
- **Rear platform** functions as a power train guard and provides safe, stable work area. Fenders and mud flaps protect from material thrown by tires.

NOTE: Listed features may be standard on some models. Optional on others. Contact your Caterpillar Dealer for specific information.



MODEL	769D		769D		771D	
	Flat Floor		Dual Slope		Quarry	
Body Type						
Gross Vehicle Weight	68 180 kg	150,000 lb	68 180 kg	150,000 lb	73 970 kg	163,100 lb
Chassis Weight*	22 950 kg	50,600 lb	22 950 kg	50,600 lb	22 950 kg	50,600 lb
Body Weight	7800 kg	17,200 lb	7330 kg	16,170 lb	10 350 kg	22,820 lb
Maximum Payload**	37 430 kg	82,533 lb	37 900 kg	83,570 lb	40 670 kg	89,680 lb
Standard Liner Weight	3300 kg	7280 lb	3160 kg	6970 lb	—	—
Payload with Standard Liner	34 130 kg	75,250 lb	34 740 kg	76,600 lb	—	—
Capacity:						
Struck (SAE)	16.5 m ³	21.6 yd³	17 m ³	22.2 yd³	20.2 m ³	26.4 yd³
Heaped (2:1) (SAE)	24.2 m ³	31.7 yd³	24.2 m ³	31.7 yd³	27.5 m ³	36 yd³
Distribution Empty:						
Front	49.7%		49.8%		46.3%	
Rear	50.3%		50.2%		53.7%	
Distribution Loaded:						
Front	33.2%		33.3%		32.9%	
Rear	66.8%		66.7%		67.1%	
Engine Model	3408E		3408E		3408E	
Number of Cylinders	8		8		8	
Bore	137 mm	5.4"	137 mm	5.4"	137 mm	5.4"
Stroke	152 mm	6"	152 mm	6"	152 mm	6"
Displacement	18 L	1099 in³	18 L	1099 in³	18 L	1099 in³
Flywheel Power	362 kW	485 hp	362 kW	485 hp	362 kW	485 hp
Gross Power	380 kW	510 hp	380 kW	510 hp	380 kW	510 hp
Standard Tires	18.00R33(E-4)		18.00R33(E-4)		18.00R33(E-4)	
Machine Clearance Turning Circle	19.8 m	65'0"	19.8 m	65'0"	19.8 m	65'0"
Fuel Tank Refill Capacity	530 L	140 U.S. gal	530 L	140 U.S. gal	530 L	140 U.S. gal
Top Speed (Loaded)	75 km/h	47 mph	75 km/h	47 mph	56 km/h	35 mph
GENERAL DIMENSIONS						
(Empty):						
Height to Canopy Rock Guard Rail	4.07 m	13'4"	4.03 m	13'3"	4.02 m	13'2"
Wheelbase	3.71 m	12'2"	3.71 m	12'2"	3.71 m	12'2"
Overall Length	8.73 m	28'7"	8.57 m	28'1"	8.73 m	28'7"
Loading Height (Empty)	3.19 m	10'6"	3.14 m	10'4"	3.40 m	11'2"
Height at Full Dump	7.75 m	25'5"	7.71 m	25'3"	7.74 m	25'5"
Body Length (Target Length)	5.43 m	17'10"	5.28 m	17'4"	5.52 m	18'1"
Width (Operating)	5.01 m	16'5"	5.01 m	16'5"	5.01 m	16'5"
Width (Shipping)***	3.95 m	12'11"	3.95 m	12'11"	3.95 m	12'11"
Front Tire Tread	3.10 m	10'2"	3.10 m	10'2"	3.10 m	10'2"

*Weights include lubricants, coolants, and 10% fuel.

**Maximum rating requires selection of proper tires and is dependent on selection of optional equipment. Gross vehicle weight should not be exceeded.

***Disassembled.



MODEL	773D		773D		775D		775D	
	Flat Floor		Dual Slope		Quarry		Lined Quarry	
Body Type	Flat Floor		Dual Slope		Quarry		Lined Quarry	
Gross Vehicle Weight	92 530 kg	204,000 lb	92 530 kg	204,000 lb	106 590 kg	235,000 lb	106 590 kg	235,000 lb
Chassis Weight*	30 165 kg	66,500 lb	30 165 kg	66,500 lb	30 390 kg	67,000 lb	30 390 kg	67,000 lb
Body Weight	9375 kg	20,670 lb	9030 kg	19,910 lb	12 830 kg	28,230 lb	14 140 kg	31,170 lb
Maximum Payload**	52 990 kg	116,840 lb	53 340 kg	117,610 lb	63 370 kg	139,730 lb	62 070 kg	136,860 lb
Standard Liner Weight	3981 kg	8778 lb	3920 kg	8640 lb	—	—	—	—
Payload with Standard Liner	49 010 kg	108,065 lb	49 420 kg	108,970 lb	—	—	62 070 kg	136,860 lb
Capacity:								
Struck (SAE)	26.6 m ³	34.8 yd³	26.6 m ³	34.8 yd³	31.4 m ³	41.1 yd³	31.2 m ³	40.8 yd³
Heaped (2:1) (SAE)	35.5 m ³	46.4 yd³	35.2 m ³	46 yd³	41.5 m ³	54.3 yd³	41.2 m ³	53.9 yd³
Distribution Empty:								
Front		47.3%		47.3%		44.3%		44.3%
Rear		52.7%		52.7%		55.7%		55.7%
Distribution Loaded:								
Front		33.3%		33.3%		31.2%		31.2%
Rear		66.7%		66.7%		68.8%		68.8%
Engine Model	3412E		3412E		3412E		3412E	
Number of Cylinders	12		12		12		12	
Bore	137 mm	5.4"	137 mm	5.4"	137 mm	5.4"	137 mm	5.4"
Stroke	152 mm	6"	152 mm	6"	152 mm	6"	152 mm	6"
Displacement	27 L	1649 in³	27 L	1649 in³	27 L	1649 in³	27 L	1649 in³
Flywheel Power	485 kW	650 hp	485 kW	650 hp	517 kW	693 hp	517 kW	693 hp
Gross Power	509 kW	682 hp	509 kW	682 hp	541 kW	725 hp	541 kW	725 hp
Standard Tires	24.00R35(E-4)		24.00R35(E-4)		24.00R35(E-4)		24.00R35(E-4)	
Machine Clearance								
Turning Circle	24 m	78'9"	24 m	78'9"	24 m	78'9"	24 m	78'9"
Fuel Tank Refill Capacity	700 L	185 U.S. gal	700 L	185 U.S. gal	700 L	185 U.S. gal	700 L	185 U.S. gal
Top Speed (Loaded)	66 km/h	41 mph	66 km/h	41 mph	66 km/h	41 mph	66 km/h	41 mph
GENERAL DIMENSIONS (Empty):								
Height to Canopy Rock Guard Rail	4.42 m	14'6"	4.39 m	14'5"	4.41 m	14'5"	4.41 m	14'5"
Wheelbase	4.19 m	13'9"	4.19 m	13'9"	4.19 m	13'9"	4.19 m	13'9"
Overall Length	9.70 m	31'10"	9.61 m	31'6"	9.70 m	31'10"	9.70 m	31'10"
Loading Height (Empty)	3.79 m	12'5"	3.77 m	12'5"	3.91 m	12'10"	3.91 m	12'10"
Height at Full Dump	8.82 m	28'11"	8.79 m	28'10"	8.80 m	28'10"	8.80 m	28'10"
Body Length (Target Length)	6.49 m	21'3"	6.40 m	21'0"	6.54 m	21'5"	6.51 m	21'4"
Width (Operating)	5.08 m	16'8"	5.08 m	16'8"	5.21 m	17'1"	5.21 m	17'1"
Width (Shipping)***	3.97 m	13'0"	3.97 m	13'0"	3.97 m	13'0"	3.97 m	13'0"
Front Tire Tread	3.28 m	10'9"	3.28 m	10'9"	3.28 m	10'9"	3.28 m	10'9"

*Weights include lubricants, coolants, and 10% fuel.

**Maximum rating requires selection of proper tires and is dependent on selection of optional equipment. Gross vehicle weight should not be exceeded.

***Disassembled.



MODEL	777D		777D		785C		785C	
	Flat Floor		Dual Slope		Flat Floor		Dual Slope	
Body Type								
Gross Vehicle Weight	161 030 kg	355,000 lb	161 030 kg	355,000 lb	249 480 kg	550,000 lb	249 480 kg	550,000 lb
Chassis Weight*	48 580 kg	107,100 lb	48 580 kg	107,100 lb	74 450 kg	164,170 lb	74 450 kg	164,170 lb
Body Weight	16 430 kg	36,185 lb	15 780 kg	34,785 lb	24 610 kg	54,200 lb	21 280 kg	46,870 lb
Maximum Payload**	96 020 kg	211,710 lb	96 670 kg	213,110 lb	150 560 kg	331,630 lb	153 890 kg	338,970 lb
Standard Liner Weight	5675 kg	12,500 lb	5460 kg	12,040 lb	1090 kg	2400 lb	7640 kg	16,840 lb
Payload with Standard Liner	90 340 kg	199,210 lb	91 210 kg	201,070 lb	149 470 kg	329,230 lb	146 250 kg	322,130 lb
Capacity:								
Struck (SAE)	42.0 m ³	54.6 yd³	42.1 m ³	55 yd³	74 m ³	96 yd³	57 m ³	74 yd³
Heaped (2:1) (SAE)	60.5 m ³	79.1 yd³	60.1 m ³	78.6 yd³	91 m ³	119 yd³	78 m ³	102 yd³
Distribution Empty:								
Front	47%		47%		47%		47%	
Rear	53%		53%		53%		53%	
Distribution Loaded:								
Front	47%		33%		32%		33%	
Rear	53%		67%		68%		67%	
Engine Model	3508B		3508B		3512		3512	
Number of Cylinders	8		8		12		12	
Bore	170 mm	6.7"	170 mm	6.7"	170 mm	6.7"	170 mm	6.7"
Stroke	190 mm	7.5"	190 mm	7.5"	190 mm	7.5"	190 mm	7.5"
Displacement	34.5 L	2105 in³	34.5 L	2105 in³	51.8 L	3158 in³	51.8 L	3158 in³
Flywheel Power	699 kW	938 hp	699 kW	938 hp	962 kW	1290 hp	962 kW	1290 hp
Gross Power	746 kW	1000 hp	746 kW	1000 hp	1029 kW	1380 hp	1029 kW	1380 hp
Standard Tires	27.00R49		27.00R49		33.00R51		33.00R51	
Machine Clearance								
Turning Circle	26.1 m	85'6"	26.1 m	85'6"	30.2 m	99'2"	30.2 m	99'2"
Fuel Tank Refill Capacity	1137 L	300 U.S. gal	1137 L	300 U.S. gal	1893 L	500 U.S. gal	1893 L	500 U.S. gal
Top Speed (Loaded)	60 km/h	38 mph	60 km/h	38 mph	56 km/h	35 mph	56 km/h	35 mph
GENERAL DIMENSIONS (Empty):								
Height to Canopy Rock Guard Rail	5.00 m	16'5"	4.95 m	16'3"	5.93 m	19'6"	5.77 m	18'11"
Wheelbase	4.57 m	15'0"	4.57 m	15'0"	5.18 m	17'0"	5.18 m	17'0"
Overall Length	9.78 m	32'1"	9.78 m	32'1"	11.02 m	36'2"	11.02 m	36'2"
Loading Height (Empty)	4.34 m	14'3"	4.29 m	14'1"	5.55 m	18'3"	4.98 m	16'4"
Height at Full Dump	9.97 m	32'9"	9.95 m	32'8"	11.12 m	36'6"	11.20 m	36'9"
Body Length (Target Length)	9.60 m	31'6"	6.95 m	22'10"	10.46 m	34'4"	7.65 m	25'1"
Width (Operating)	5.53 m	18'2"	6.10 m	20'0"	6.79 m	22'3"	6.64 m	21'9"
Width (Shipping)***	3.51 m	11'6"	3.51 m	11'6"	3.84 m	12'6"	3.84 m	12'6"
Front Tire Tread	4.17 m	13'8"	4.17 m	13'8"	4.85 m	15'11"	4.85 m	15'11"

*Weights include lubricants, coolants, and 10% fuel.

**Maximum rating requires selection of proper tires and is dependent on selection of optional equipment. Gross vehicle weight should not be exceeded.

***Disassembled.

Specifications

Construction & Mining Trucks



MODEL	789C		789C		793C		793C	
	Flat Floor		Dual Slope		Flat Floor		Dual Slope	
Body Type	Flat Floor		Dual Slope		Flat Floor		Dual Slope	
Gross Vehicle Weight	317 520 kg	700,000 lb	317 520 kg	700,000 lb	376 820 kg	830,000 lb	376 820 kg	830,000 lb
Chassis Weight*	95 220 kg	209,930 lb	95 220 kg	209,930 lb	113 510 kg	250,250 lb	113 510 kg	250,250 lb
Body Weight	30 220 kg	66,570 lb	26 305 kg	57,940 lb	32 980 kg	72,650 lb	31 200 kg	68,800 lb
Maximum Payload**	192 270 kg	423,500 lb	196 190 kg	432,130 lb	230 320 kg	507,100 lb	232 105 kg	510,950 lb
Standard Liner Weight	1360 kg	3000 lb	9440 kg	20,790 lb	1360 kg	3000 lb	11 070 kg	24,420 lb
Payload with Standard Liner	190 910 kg	420,500 lb	186 750 kg	411,340 lb	228 860 kg	504,100 lb	221 030 kg	486,530 lb
Capacity:								
Struck (SAE)	94 m ³	123 yd³	73 m ³	96 yd³	120 m ³	157 yd³	96 m ³	126 yd³
Heaped (2:1) (SAE)	121.5 m ³	158 yd³	105 m ³	137 yd³	147.5 m ³	193 yd³	129 m ³	169 yd³
Distribution Empty:								
Front		47%		47%		47%		47%
Rear		53%		53%		53%		53%
Distribution Loaded:								
Front		32%		33%		32%		33%
Rear		68%		67%		68%		67%
Engine Model	3516		3516		3516B		3516B	
Number of Cylinders	16		16		16		16	
Bore	170 mm	6.7"	170 mm	6.7"	170 mm	6.7"	170 mm	6.7"
Stroke	190 mm	7.5"	190 mm	7.5"	190 mm	7.5"	190 mm	7.5"
Displacement	69 L	4211 in³	69 L	4211 in³	69 L	4211 in³	69 L	4211 in³
Flywheel Power	1272 kW	1705 hp	1272 kW	1705 hp	1616 kW	2166 hp	1616 kW	2166 hp
Gross Power	1342 kW	1800 hp	1342 kW	1800 hp	1716 kW	2300 hp	1716 kW	2300 hp
Standard Tires	37.00R57		37.00R57		40.00R57		40.00R57	
Machine Clearance								
Turning Circle	30.2 m	99'2"	30.2 m	99'2"	30.2 m	99'2"	30.2 m	99'2"
Fuel Tank Refill Capacity	3222 L	851 U.S. gal	3222 L	851 U.S. gal	3861 L	1020 U.S. gal	3861 L	1020 U.S. gal
Top Speed (Loaded)	54 km/h	34 mph	54 km/h	34 mph	55 km/h	34 mph	55 km/h	34 mph
GENERAL DIMENSIONS (Empty):								
Height to Canopy Rock Guard Rail	6.16 m	20'3"	6.15 m	20'2"	6.56 m	21'6"	6.43 m	21'1"
Wheelbase	5.70 m	18'8"	5.90 m	18'8"	5.90 m	19'4"	5.90 m	19'4"
Overall Length	12.13 m	39'9"	12.18 m	39'11"	13.23 m	43'4"	12.86 m	42'3"
Loading Height (Empty)	5.69 m	18'8"	5.21 m	17'1"	6.40 m	20'11"	5.86 m	19'3"
Height at Full Dump	11.93 m	39'2"	11.91 m	39'1"	13.14 m	43'1"	13.21 m	43'4"
Body Length (Target Length)	11.62 m	38'2"	8.15 m	26'9"	12.67 m	41'7"	8.94 m	29'4"
Width (Operating)	7.97 m	26'2"	7.67 m	25'2"	8.02 m	26'8"	7.42 m	24'4"
Width (Shipping)***	3.84 m	12'6"	3.84 m	12'6"	3.84 m	12'6"	3.84 m	12'6"
Front Tire Tread	5.43 m	17'10"	5.43 m	17'10"	5.61 m	18'5"	5.61 m	18'5"

*Weights include lubricants, coolants, and 10% fuel.

**Maximum rating requires selection of proper tires and is dependent on selection of optional equipment. Gross vehicle weight should not be exceeded.

***Disassembled.



MODEL	776D		784C	
Flywheel Power	699 kW	938 hp	962 kW	1290 hp
Gross Power	746 kW	1000 hp	1029 kW	1380 hp
Operating Weight*	55 480 kg	122,311 lb	89 280 kg	196,825 lb
Engine Model	3508B (EUI)		3512 (EUI)	
No. Cylinders	8		12	
Bore	170 mm	6.7"	170 mm	6.7"
Stroke	190 mm	7.5"	190 mm	7.5"
Displacement	34.5 L	2105 in³	51.8 L	3158 in³
Standard Tires, Front & Dual Rear	27.00R49 (E-4)		36.00R51 (E-3)	
Machine Clearance				
Turning Circle	26.1 m	85'6"	33.5 m	109'10"
Fuel Tank Refill Capacity	1137 L	300 U.S. gal	3222 L	851 U.S. gal
GENERAL DIMENSIONS				
(Empty):				
Height to Top of Cab	4.57 m	15'0"	5468 mm	17'1"
Wheelbase	4.57 m	15'0"	5180 mm	17'
Overall Length	8.06 m	26'5.5"	9343 mm	30'8"
Ground Clearance	200 mm	2'4"	1027 mm	3'4"
Width, shipping (Disassembled)	3.51 m	11'6"	3810 mm	12'6"
Height to Yoke Seat	3.40 m	11'2"	4048 mm	13'4"
Rear axle to Hitch Pin	762 mm	2'6"	850 mm	2'9"
Front Tire Tread	4.17 m	13'8"	4935 mm	16'2"

*Operating Weights include coolant, lubricants, hitch, full fuel tank and operator.

MODEL TIRE SIZE	PLY RATING/ STAR RATING*	TYPE
769D		
18.00-33	32	E-4
18.00R33	★★	E-3
18.00R33◀	★★	E-4
771D		
18.00R33◀	★★	E-4
773D		
24.00-35	36	E-4
24.00-35	42	E-4
24.00R35	★★	E-3
24.00R35◀	★★	E-4
775D		
24.00R35◀	★★	E-4
24.00R35	★★	E-3
24.00-35	42	E-4
777D		
27.00R49	★★	E-3
27.00R49◀	★★	E-4
785C		
33.00R51	★★	E-3
33.00R51	★★	E-4

MODEL TIRE SIZE	PLY RATING/ STAR RATING*	TYPE
789C		
37.00R57	★★	E-4
793C		
40.00R57	★★	E-4
776D		
27.00R49	★★	E-3
27.00R49◀	★★	E-4
784C		
36.00R51	★★	E-3

*Manufacturer uses star (★) rating system instead of ply rating.

◀Standard Tire.

USE OF BRAKE PERFORMANCE CURVES

The speed that can be maintained when the machine is descending a grade with retarder applied can be determined from the retarder curves in this section when gross machine weight and total effective grade are known.

Select appropriate grade distance chart that covers total downhill haul; don't break haul into individual segments.

To determine brake performance: Read from gross weight down to the percent effective grade. (Effective grade equals actual % grade *minus* 1% for each 10 kg/metric ton (20 lb./U.S. ton) of rolling resistance.) From this weight-effective grade point, read horizontally to the curve with the highest obtainable speed range, then down to maximum descent speed brakes can safely handle without exceeding cooling capacity. When braking, engine RPM should be maintained at the highest possible level without overspeeding. If cooling oil overheats, reduce ground speed to allow transmission to shift to next lower speed range.

USE OF RIMPULL-SPEED-GRADEABILITY CURVES

(See Wheel Tractor Scraper Section)

Total Effective Grade (or Total Resistance) is grade assistance *minus* rolling resistance.

10 kg/metric ton (20 lb./U.S. ton) = 1% adverse grade.

Example —

With a favorable grade of 20% and rolling resistance of 50 kg/metric ton (100 lb./U.S. ton), find Total Effective Grade.

$$\begin{aligned} (50 \text{ kg/metric ton}) &= 50 \div 10 = 5\% \text{ Effective Grade} \\ &\text{(from Rolling Resistance)} \\ 100 \text{ lb/ton} &= 100 \div 20 = 5\% \text{ Effective Grade} \\ 20\% \text{ (grade)} - 5\% \text{ (resistance)} &= \\ 15\% \text{ Total Effective Grade} \end{aligned}$$

TYPICAL FIXED TIMES FOR HAULING UNITS

Wait time, delays and operator efficiency all impact cycle time. Minimizing truck exchange time can have a significant effect on productivity.

Fixed time for hauling units include:

1. Truck load time (various with loading tool)
2. Truck maneuver in load area (Truck exchange) (Typically 0.6-0.8 min.)
3. Maneuver and dump time at dump point (Typically 1.0-1.2 min.)

Total cycle time is the combination of:

1. The above fixed time
2. Hauling time (Loaded)
3. Return time (Empty)

Example — assume load tool spots hauler with full bucket

	988F	5130B
cycle times60	.45
First pass (dump time)10 min.	.05 min.
2 passes (full cycle)70	.50
3 passes "	1.30	.95
4 passes "	1.90	1.40
5 passes "	2.50	1.85
6 passes "	3.10	2.30
7 passes "	3.70	2.75
8 passes "	4.30	3.20
9 passes "	4.90	3.65
10 passes "	5.40	4.10

NOTE: Other sizes of loading tools will have different cycle times. See Wheel Loader section for **average** cycle times for truck loading.

MECHANICAL POWER TRAIN EFFICIENCIES

In selling against electric drive trucks, power train efficiency is an important consideration. To better illustrate the advantages of mechanical drive performance, grade horsepower, power train efficiency, and retarding horsepower should be compared to electric drive trucks.

Grade horsepower can be calculated by the following formula:

Metric

$$\text{grade HP} = \frac{\text{GMW (kg)} \times \text{TR} \times \text{Speed (km/h)}}{273.75}$$

English

$$= \frac{\text{GMW (lb)} \times \text{TR} \times \text{Speed (mph)}}{375}$$

where TR
(total
resistance) = Rolling resistance + Grade resistance
(expressed as a decimal)

English example

700,000 lb GMW, 2% rolling resistance, +8% actual grade at 8.2 mph would require 1530 HP

$$\frac{700,000 \times (.02 + .08) \times 8.2}{375} = 1530 \text{ HP}$$

Metric example

317 520 kg GMW, 2% rolling resistance, +8% actual grade at 13.2 km/h would require 1530 HP

$$\frac{317\,520 \times (.02 + .08) \times 13.2}{273.75} = 1530 \text{ HP}$$

We then calculate power train efficiency by dividing grade horsepower by the gross horsepower produced by the engine. Most electric drive trucks run at constant maximum horsepower while under load. Mechanical drive trucks, however, lug the engine and may produce somewhat less than maximum horsepower. Engine power curves must be utilized to determine exact horsepower produced.

Example

$$\frac{1530 \text{ grade horsepower}}{1800 \text{ gross engine HP}} \times 100 = 85\% \text{ power train efficiency}$$

This exercise illustrates the effect of an efficient mechanical drive power train and should yield results in the 80-85% efficiency range. The same calculation for electric drive trucks would be lower (70-78% range) with a maximum efficiency of about 78% for the most common systems.

Likewise, retarding horsepower being consumed by the retarding system can be calculated by the following formula:

Metric

$$\text{retarding HP} = \frac{\text{GMW (kg)} \times \text{TR} \times \text{Speed (km/h)}}{273.75}$$

English

$$= \frac{\text{GMW (lb)} \times \text{TR} \times \text{Speed (mph)}}{375}$$

where TR
(total
resistance) = Rolling resistance + Grade resistance
(expressed as a decimal)

English example

700,000 lb GMW, 2% rolling resistance, -8% actual grade at 14.7 mph would equate to -1646 HP

$$\frac{700,000 \times (.02 - .08) \times 14.7}{375} = 1646 \text{ HP}$$

Metric example

317 520 kg GMW, 2% rolling resistance, -8% actual grade at 23.6 km/h would equate to -1646 HP

$$\frac{317\,520 \times (.02 - .08) \times 23.6}{273.75} = 1646 \text{ HP}$$

This formula is intended for use in determining horsepower being consumed in the field based on field measurements. It is not intended to indicate how fast trucks should be operated on grade. Only job conditions, proper operating procedure, and good judgement should determine safe operating speeds during retarder use.

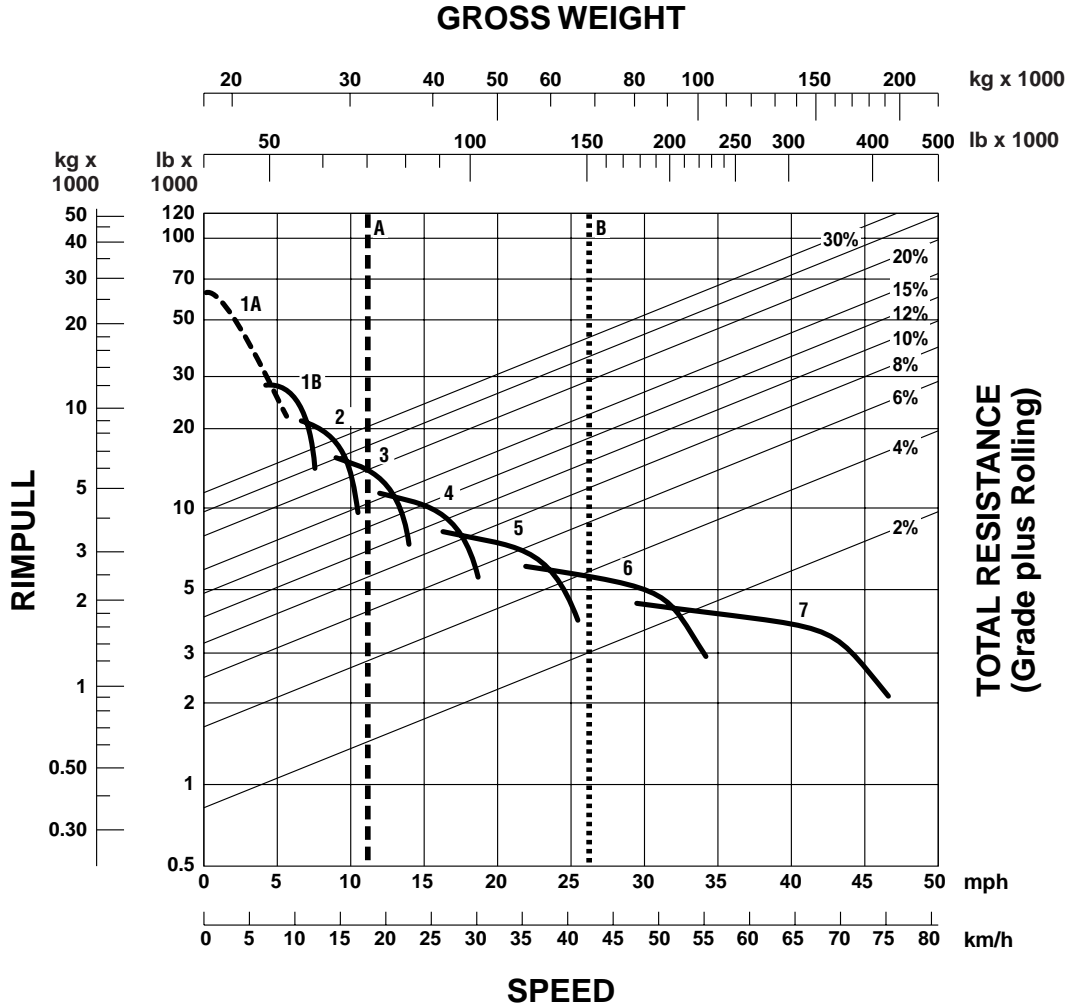

- KEY**
- 1A — 1st Gear (Torque Converter)
 - 1B — 1st Gear
 - 2 — 2nd Gear
 - 3 — 3rd Gear
 - 4 — 4th Gear
 - 5 — 5th Gear
 - 6 — 6th Gear
 - 7 — 7th Gear

- KEY**
- A — Empty 31 250 kg (68,900 lb)
 - B — Max GMW 68 182 kg (150,000 lb)

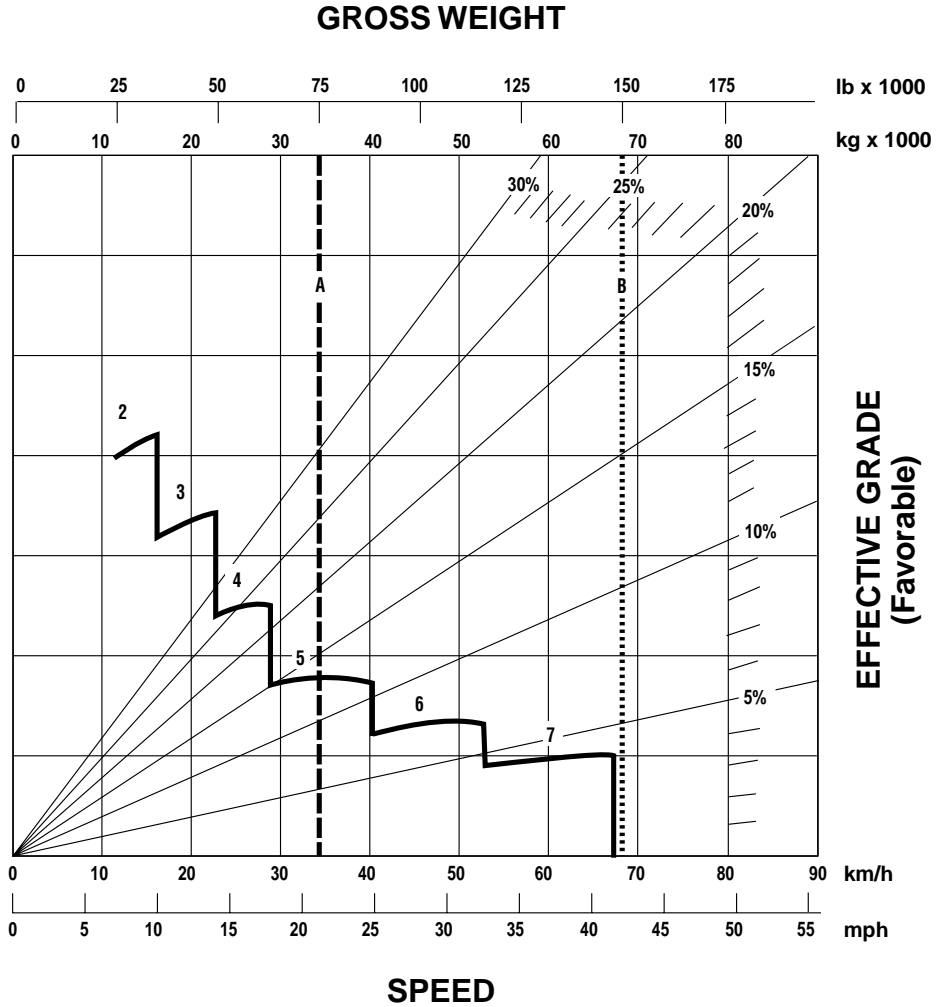

CONTINUOUS GRADE LENGTH

- KEY**
- 2 — 2nd Gear
 - 3 — 3rd Gear
 - 4 — 4th Gear
 - 5 — 5th Gear
 - 6 — 6th Gear
 - 7 — 7th Gear

- KEY**
- A — Empty 31 250 kg (68,900 lb)
 - B — Max GMW 68 182 kg (150,000 lb)

Construction & Mining Trucks

769D Brake Performance

- 450 m (1500 ft)
- 600 m (2000 ft)
- 900 m (3000 ft)
- 1500 m (5000 ft)

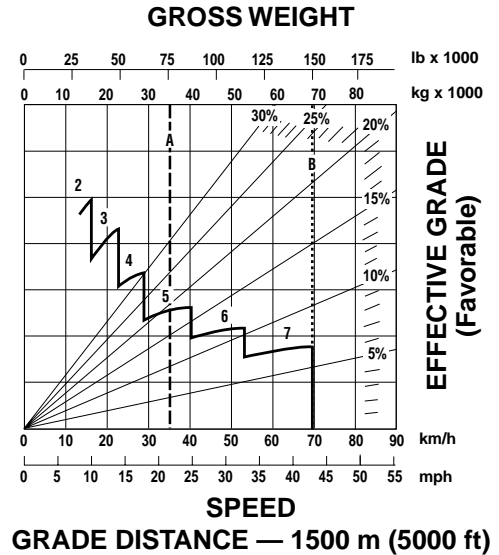
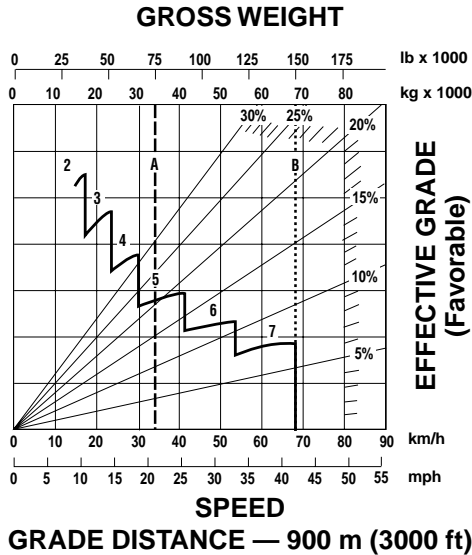
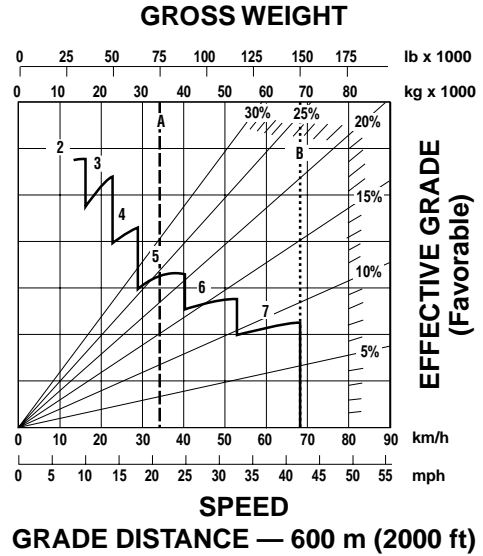
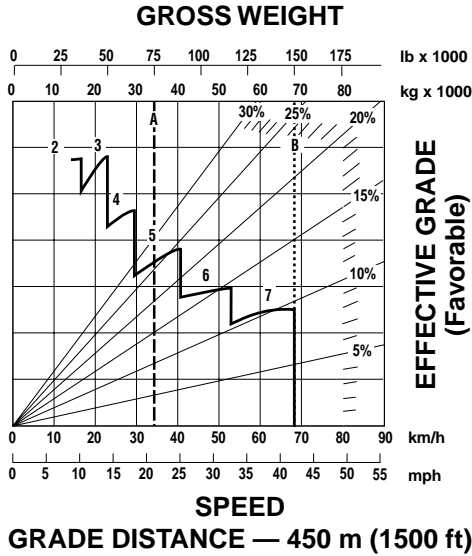

KEY

- 2 — 2nd Gear
- 3 — 3rd Gear
- 4 — 4th Gear
- 5 — 5th Gear
- 6 — 6th Gear
- 7 — 7th Gear

KEY

- A — Empty 31 250 kg (68,900 lb)
- B — Max GMW 68 182 kg (150,000 lb)

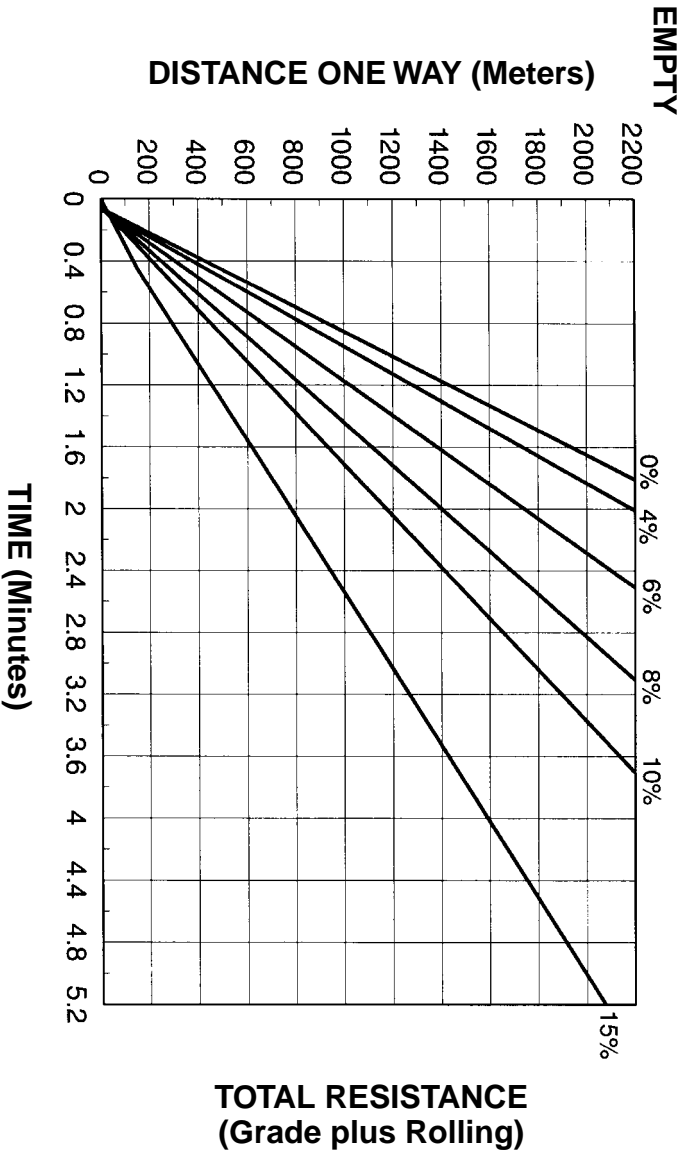
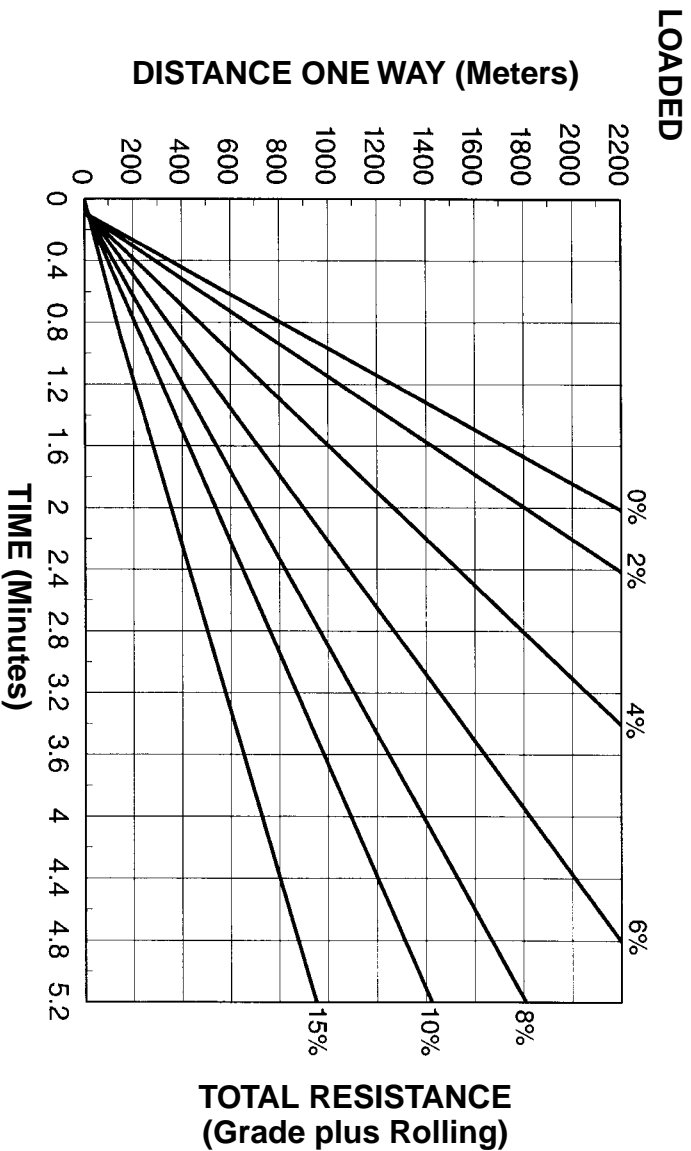

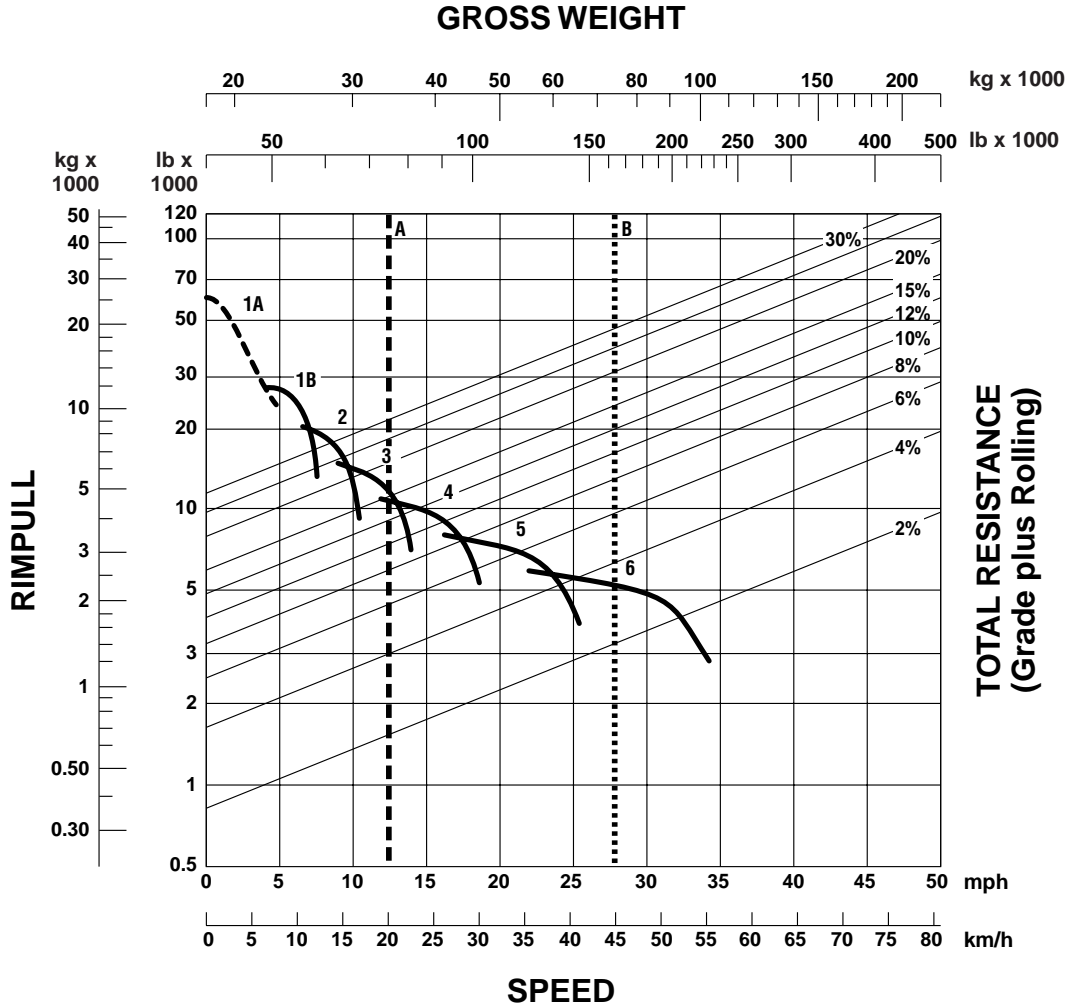

- KEY**
- 1A — 1st Gear (Torque Converter)
 - 1B — 1st Gear
 - 2 — 2nd Gear
 - 3 — 3rd Gear
 - 4 — 4th Gear
 - 5 — 5th Gear
 - 6 — 6th Gear

- KEY**
- A — Empty 33 975 kg (74,900 lb)
 - B — Max GMW 73 970 kg (163,100 lb)

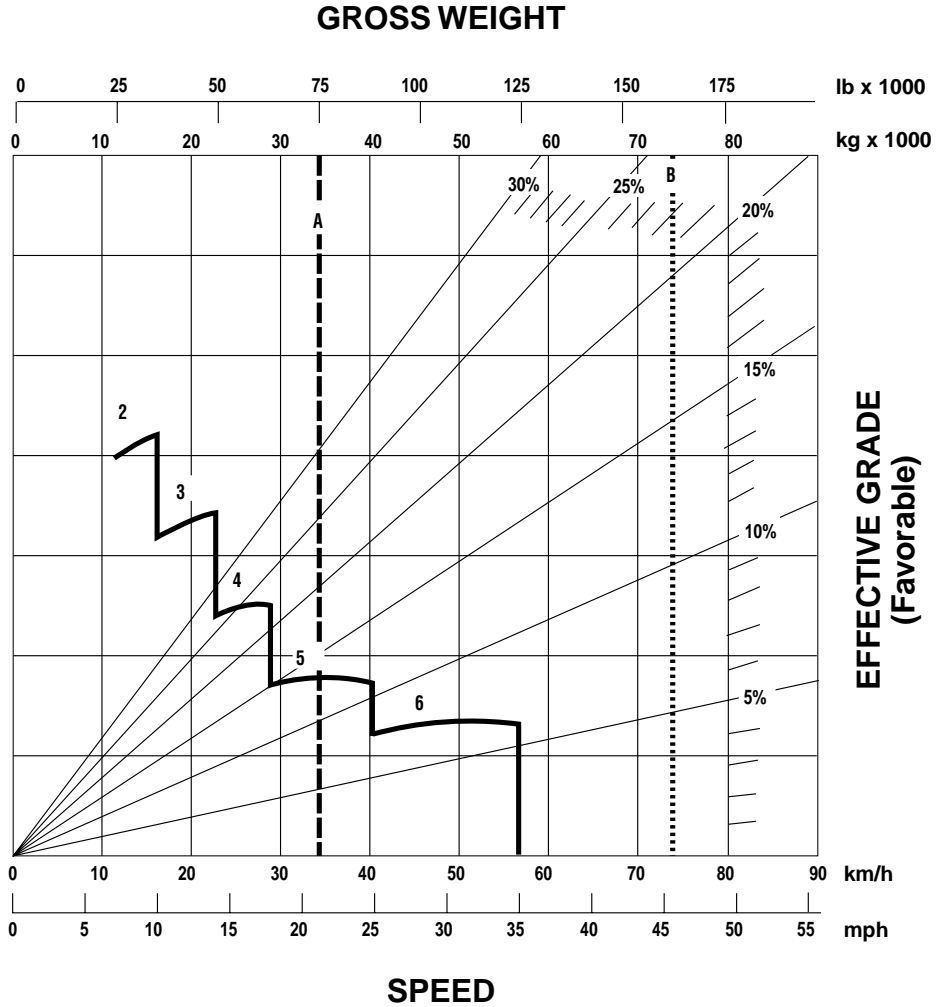

CONTINUOUS GRADE LENGTH

KEY

- 2 — 2nd Gear
- 3 — 3rd Gear
- 4 — 4th Gear
- 5 — 5th Gear
- 6 — 6th Gear

KEY

- A — Empty 33 975 kg (74,900 lb)
- B — Max GMW 73 970 kg (163,100 lb)

Construction & Mining Trucks

771D Brake Performance

- 450 m (1500 ft)
- 600 m (2000 ft)
- 900 m (3000 ft)
- 1500 m (5000 ft)

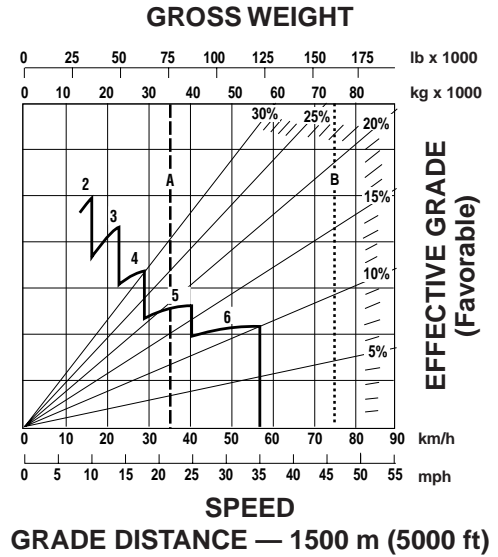
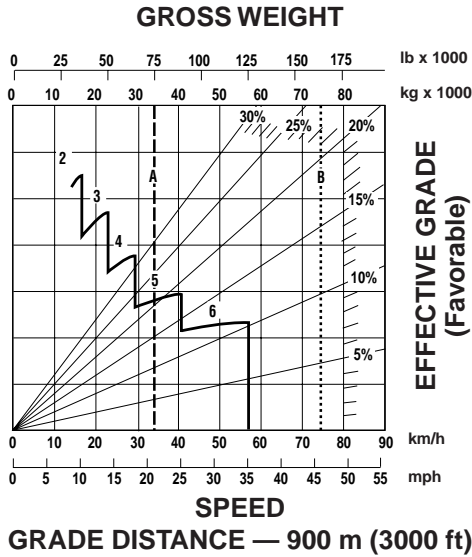
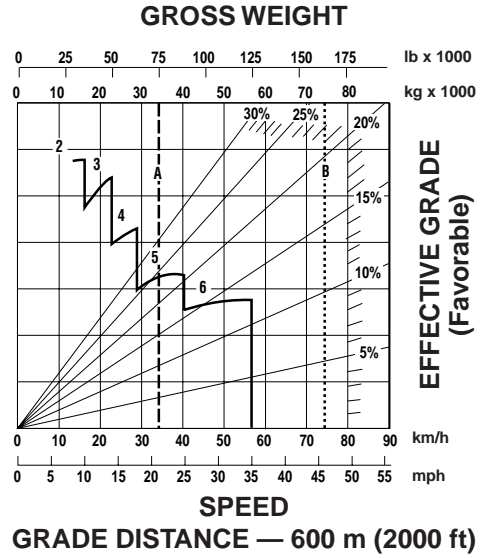
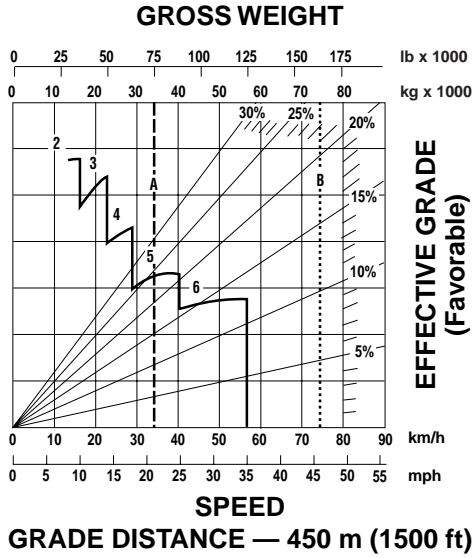

KEY

- 2 — 2nd Gear
- 3 — 3rd Gear
- 4 — 4th Gear
- 5 — 5th Gear
- 6 — 6th Gear

KEY

- A — Empty 33 975 kg (74,900 lb)
- B — Max GMW 73 970 kg (163,100 lb)

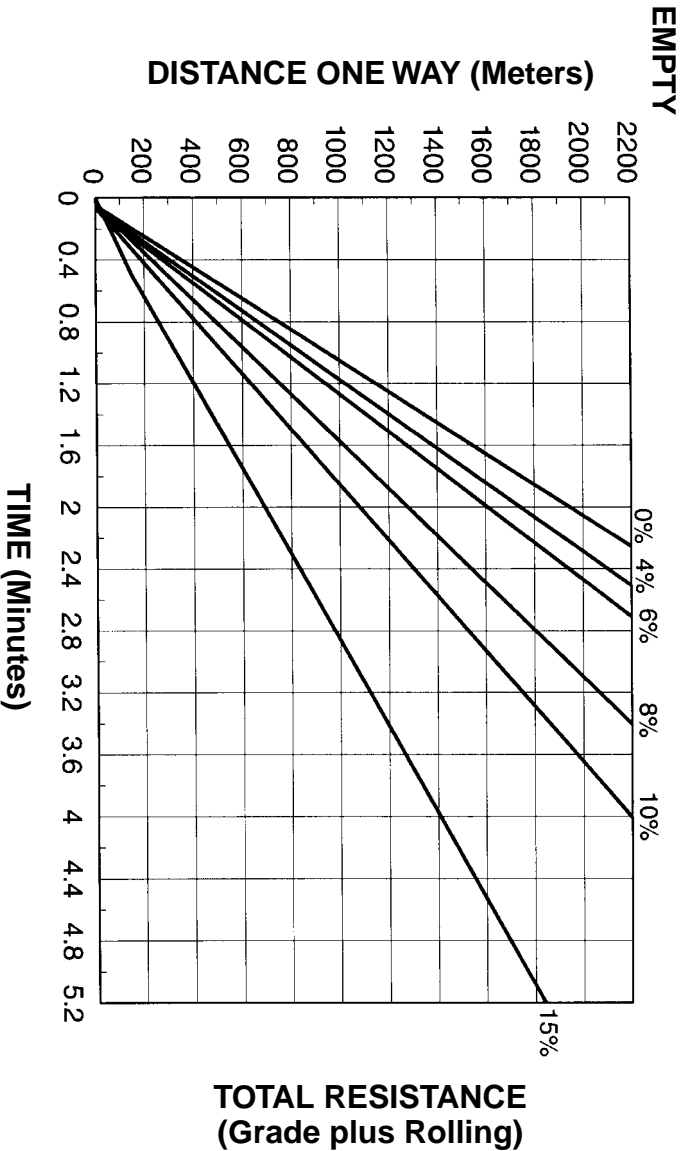
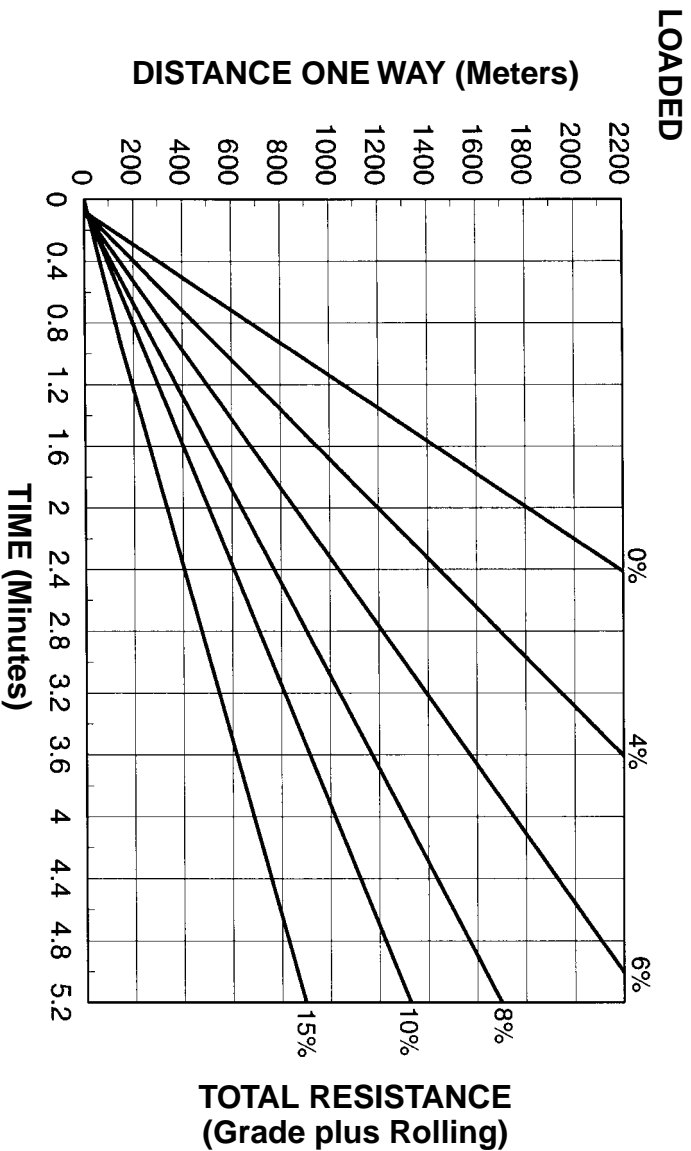

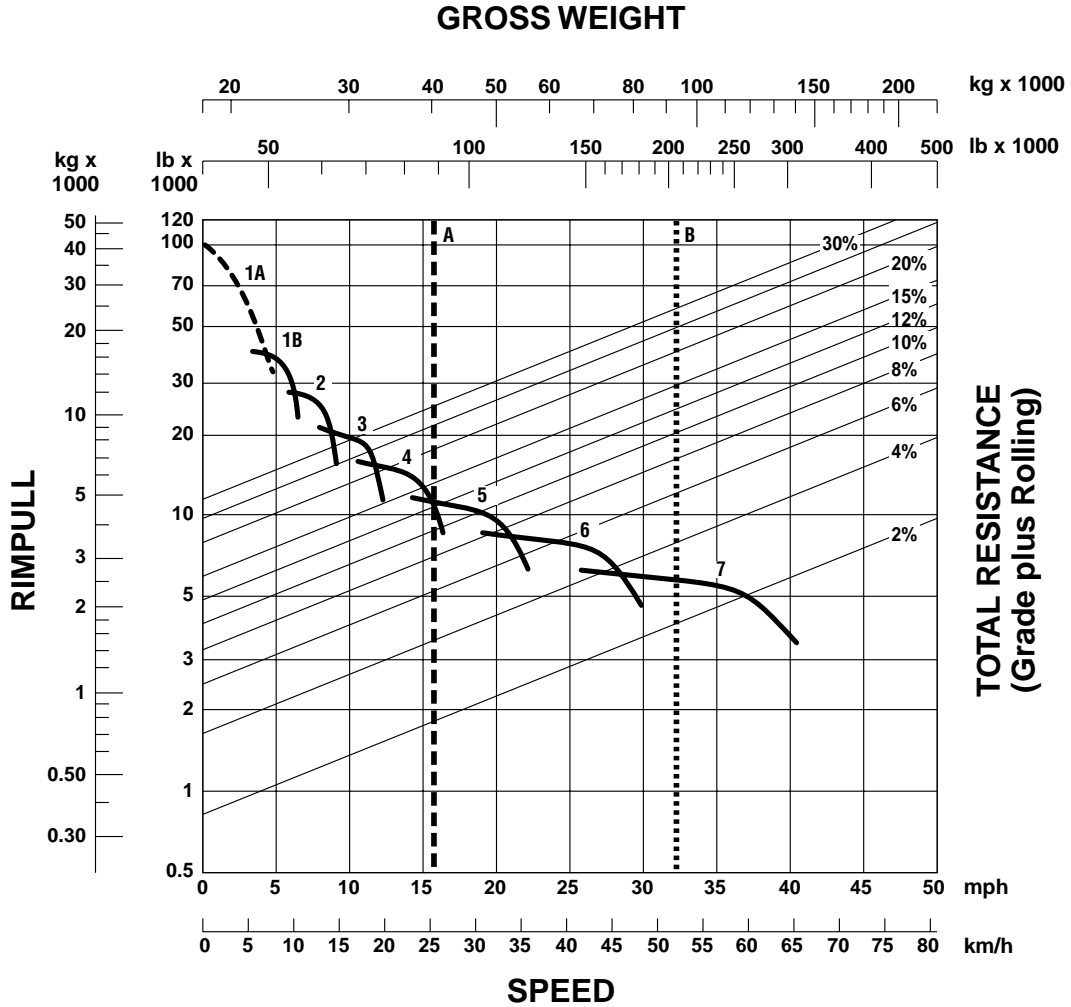

- KEY**
- 1A — 1st Gear (Torque Converter)
 - 1B — 1st Gear
 - 2 — 2nd Gear
 - 3 — 3rd Gear
 - 4 — 4th Gear
 - 5 — 5th Gear
 - 6 — 6th Gear
 - 7 — 7th Gear

- KEY**
- A — Empty 40 188 kg (88,600 lb)
 - B — Max GMW 92 534 kg (204,000 lb)

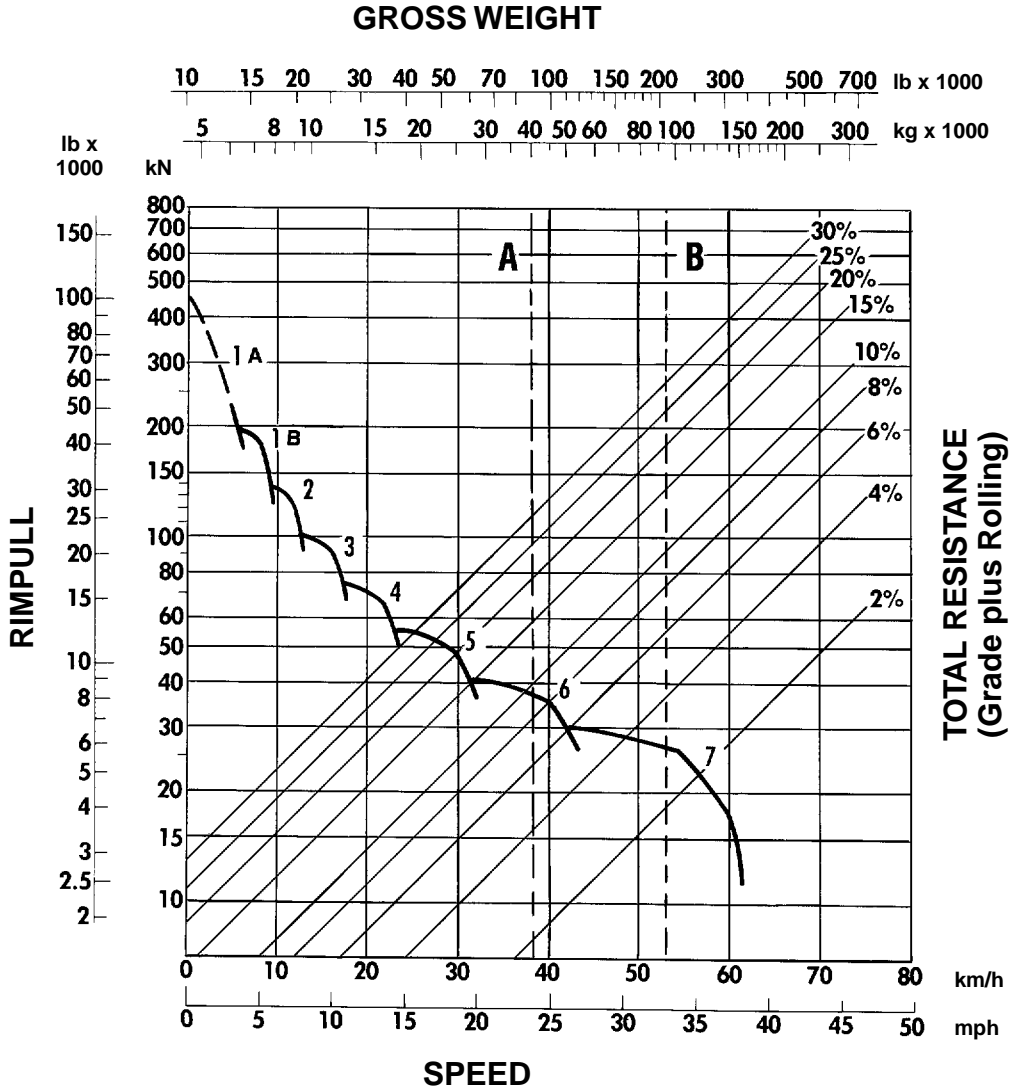

- KEY**
- 1A — 1st Gear (Torque Converter)
 - 1B — 1st Gear
 - 2 — 2nd Gear
 - 3 — 3rd Gear
 - 4 — 4th Gear
 - 5 — 5th Gear
 - 6 — 6th Gear
 - 7 — 7th Gear

- KEY**
- A — Empty 40 188 kg (88,600 lb)
 - B — Max GMW 92 534 kg (204,000 lb)

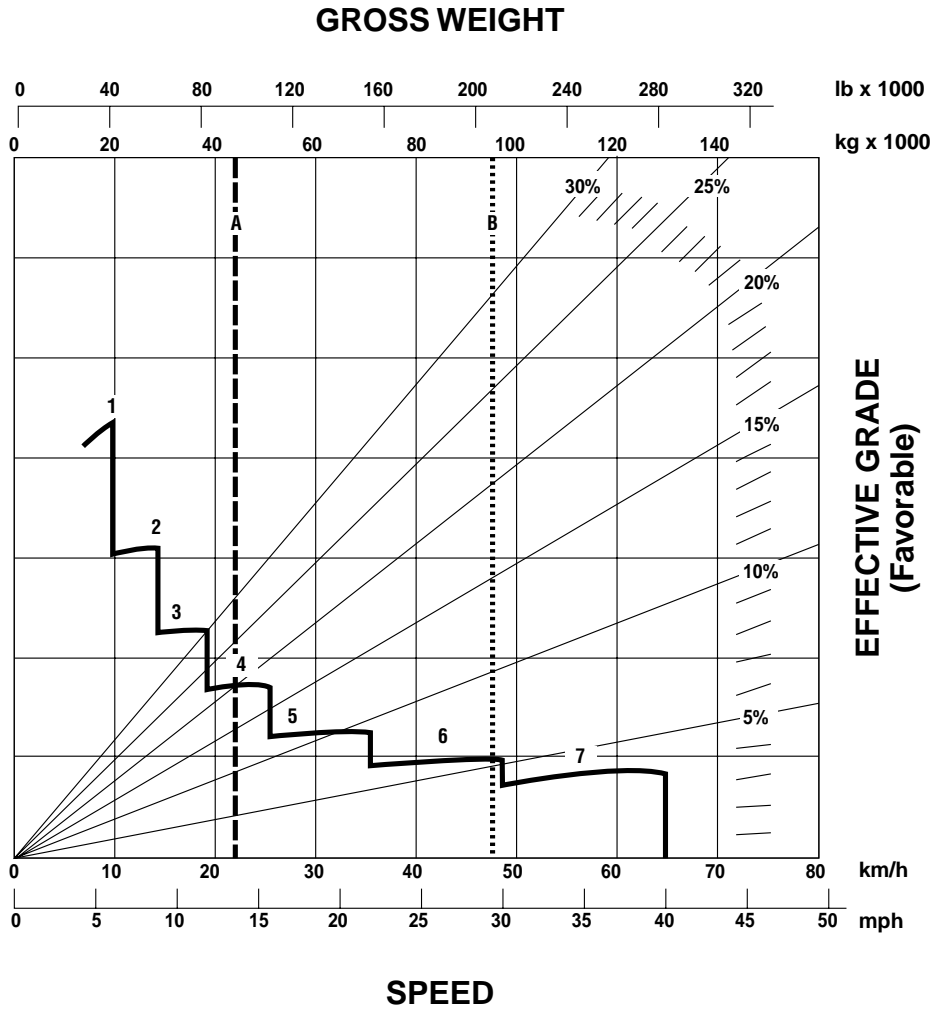

CONTINUOUS GRADE LENGTH

- KEY**
- 1 — 1st Gear
 - 2 — 2nd Gear
 - 3 — 3rd Gear
 - 4 — 4th Gear
 - 5 — 5th Gear
 - 6 — 6th Gear
 - 7 — 7th Gear

- KEY**
- A — Empty 40 188 kg (88,600 lb)
 - B — Max GMW 92 534 kg (204,000 lb)

773D Brake Performance

- 450 m (1500 ft)
- 600 m (2000 ft)
- 900 m (3000 ft)
- 1500 m (5000 ft)

Construction & Mining Trucks

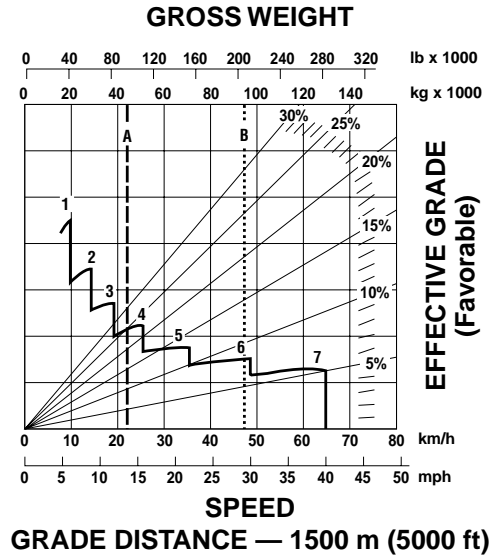
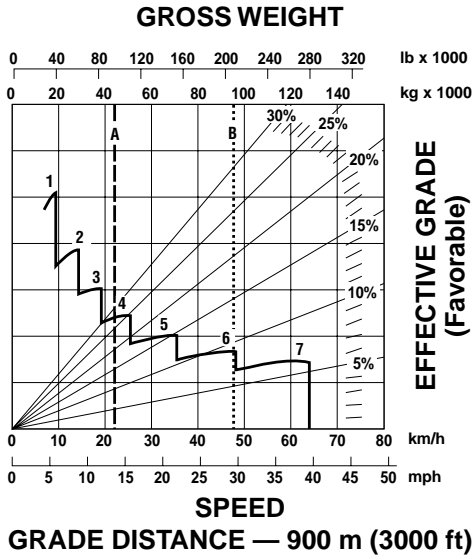
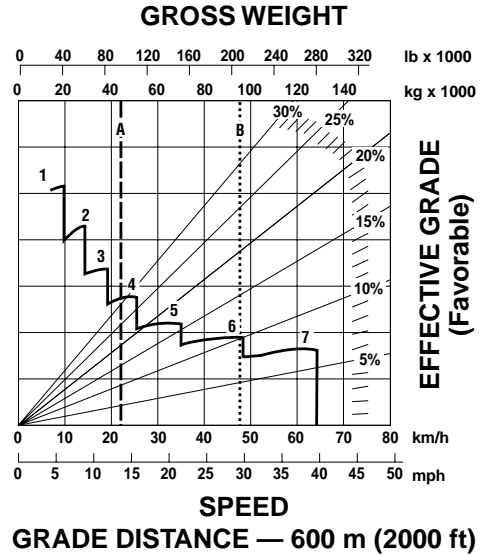
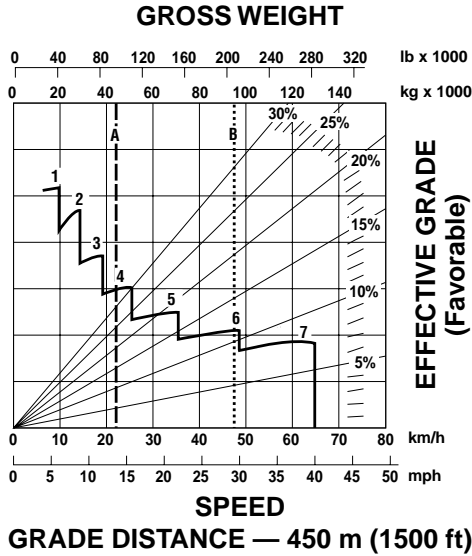

KEY

- 1 — 1st Gear
- 2 — 2nd Gear
- 3 — 3rd Gear
- 4 — 4th Gear
- 5 — 5th Gear
- 6 — 6th Gear
- 7 — 7th Gear

KEY

- A — Empty 40 188 kg (88,600 lb)
- B — Max GMW 92 534 kg (204,000 lb)

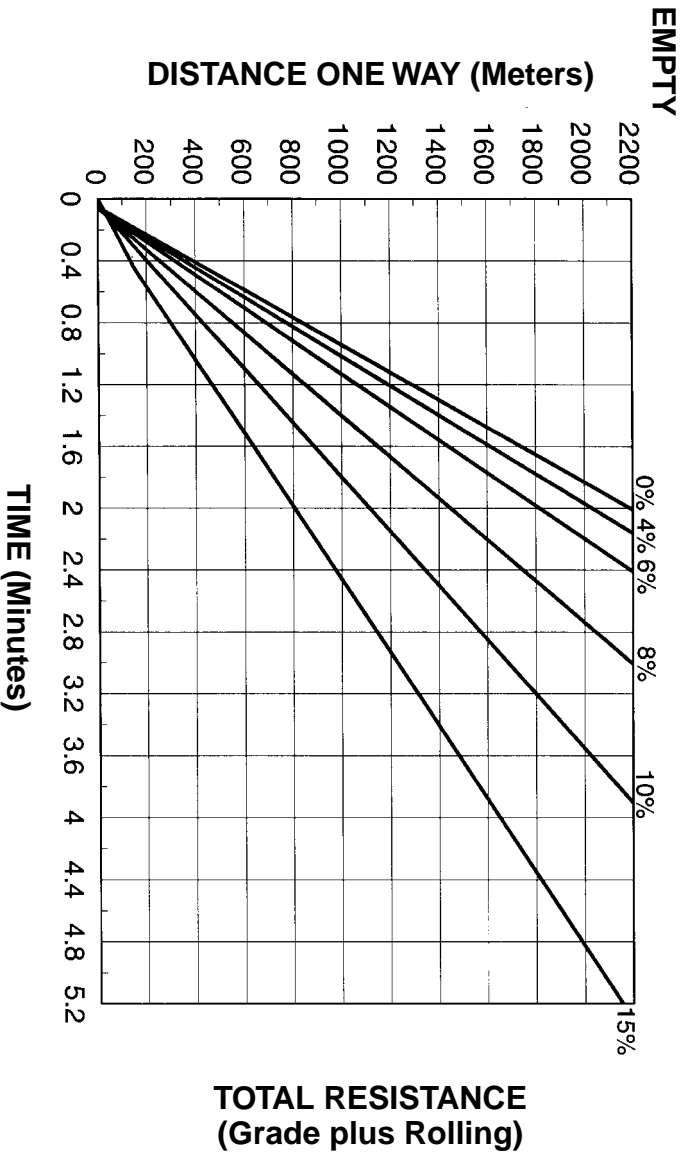
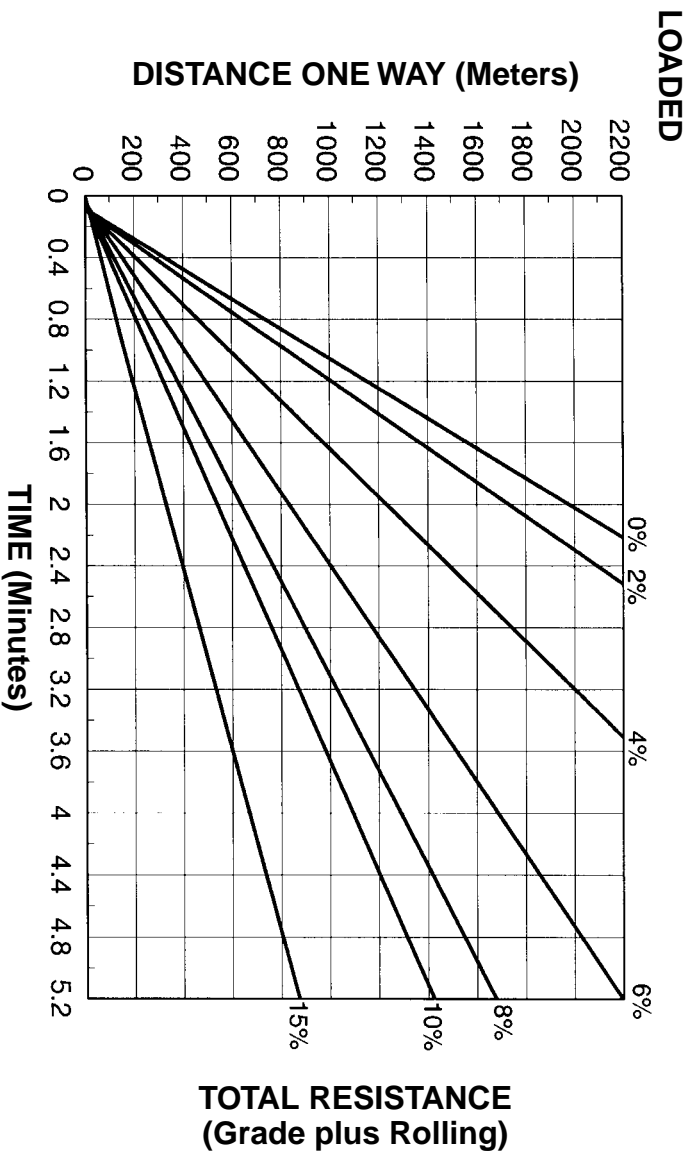

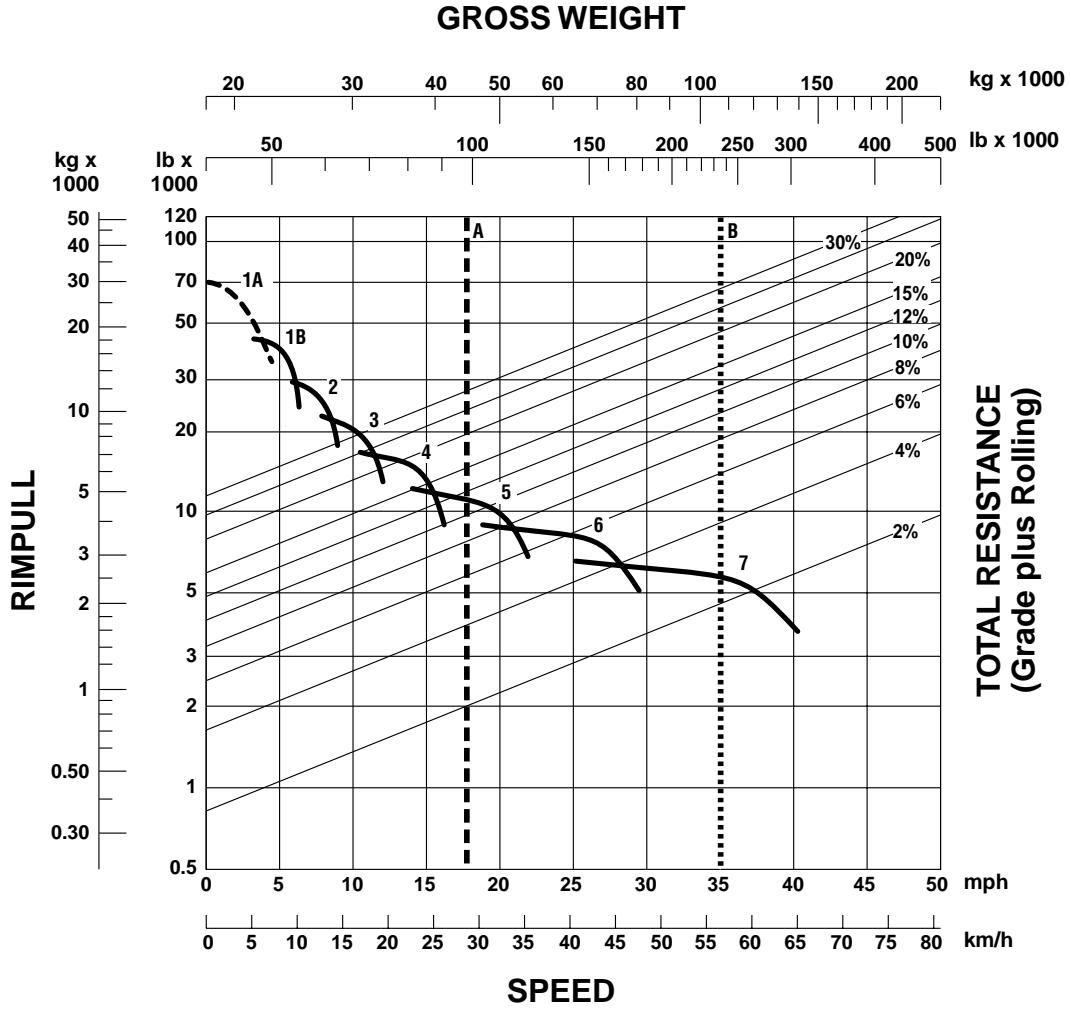

KEY

- 1A — 1st Gear (Torque Converter)
- 1B — 1st Gear
- 2 — 2nd Gear
- 3 — 3rd Gear
- 4 — 4th Gear
- 5 — 5th Gear
- 6 — 6th Gear
- 7 — 7th Gear

KEY

- A — Empty 43 953 kg (96,900 lb)
- B — Max GMW 106 594 kg (235,000 lb)

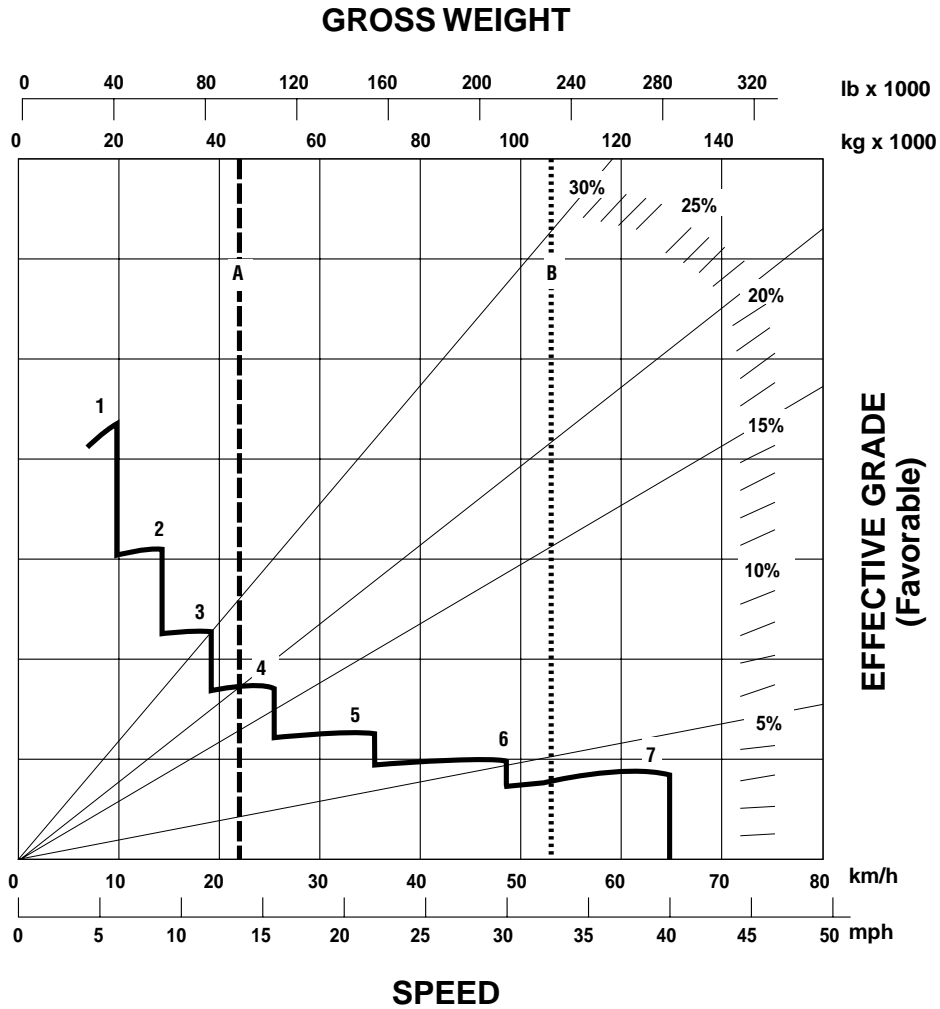

- KEY**
- 1 — 1st Gear
 - 2 — 2nd Gear
 - 3 — 3rd Gear
 - 4 — 4th Gear
 - 5 — 5th Gear
 - 6 — 6th Gear
 - 7 — 7th Gear

- KEY**
- A — Empty 43 953 kg (96,900 lb)
 - B — Max GMW 106 594 kg (235,000 lb)

775D Brake Performance

- 450 m (1500 ft)
- 600 m (2000 ft)
- 900 m (3000 ft)
- 1500 m (5000 ft)

Construction & Mining Trucks

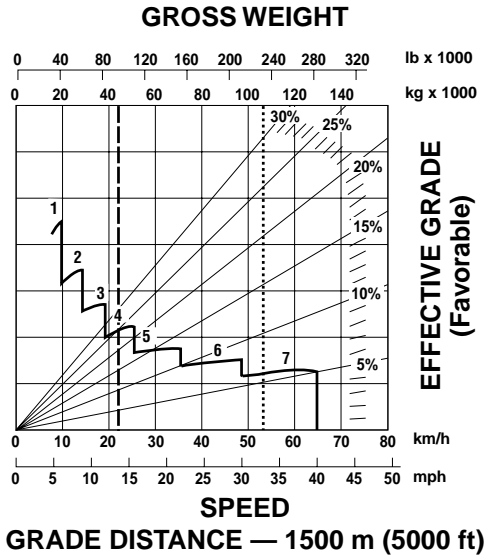
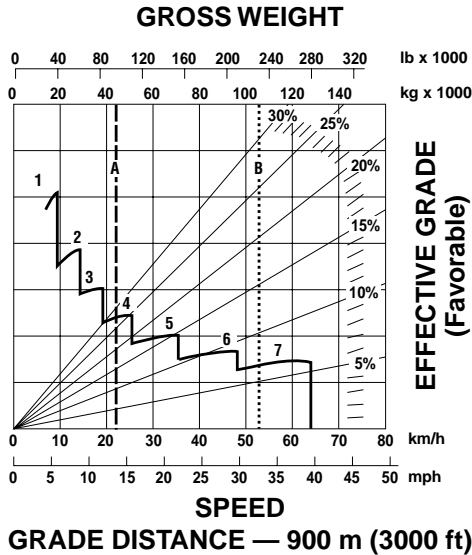
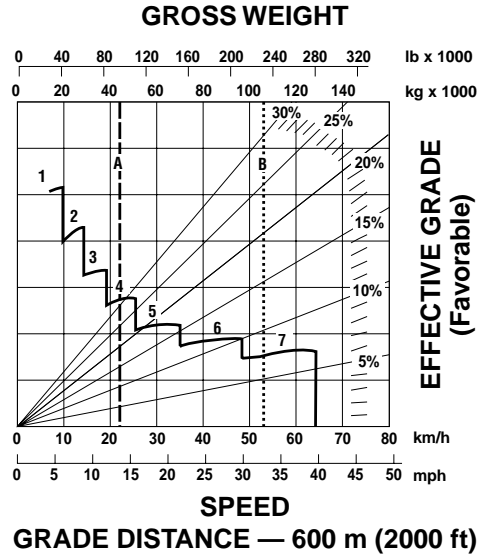
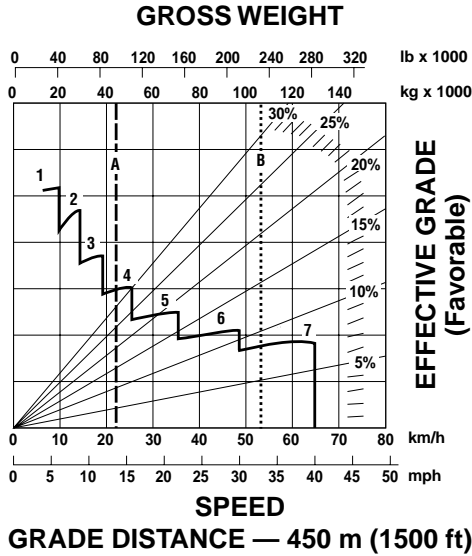

KEY

- 1 — 1st Gear
- 2 — 2nd Gear
- 3 — 3rd Gear
- 4 — 4th Gear
- 5 — 5th Gear
- 6 — 6th Gear
- 7 — 7th Gear

KEY

- A — Empty 43 953 kg (96,900 lb)
- B — Max GMW 106 594 kg (235,000 lb)

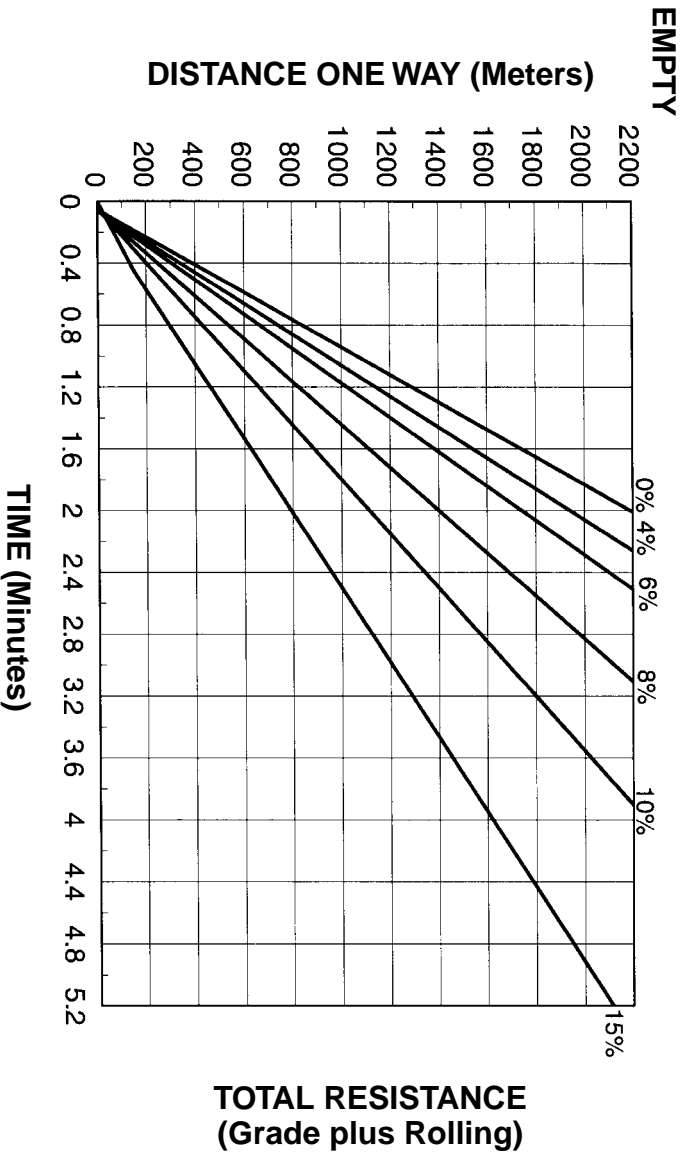
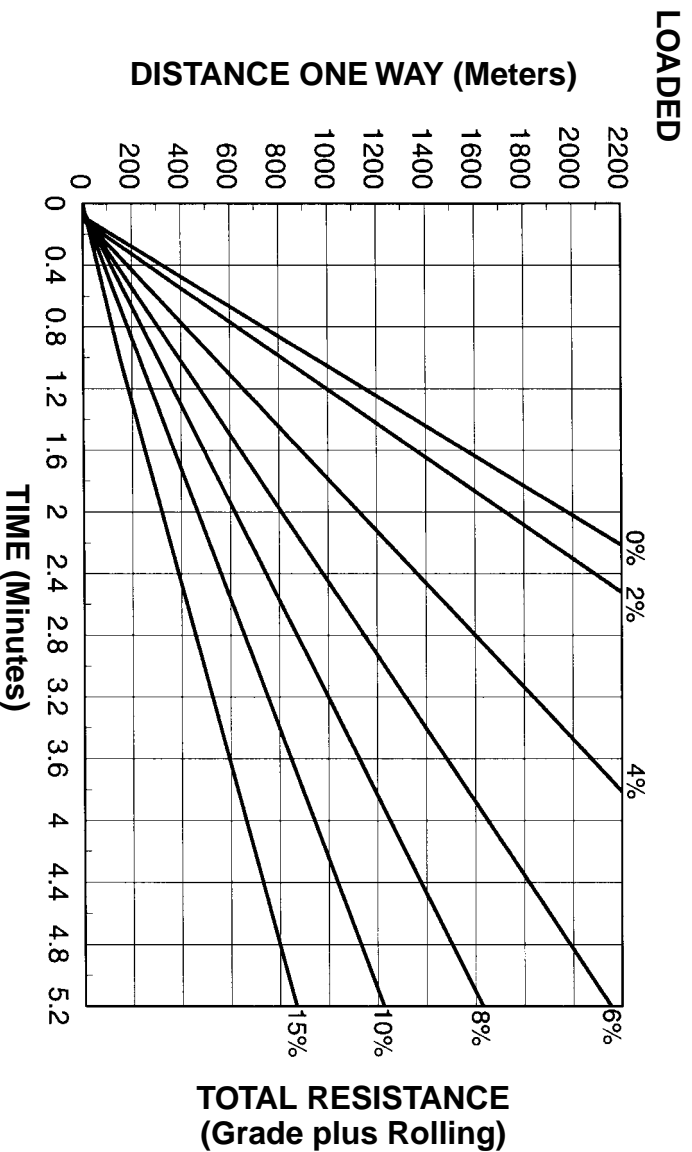

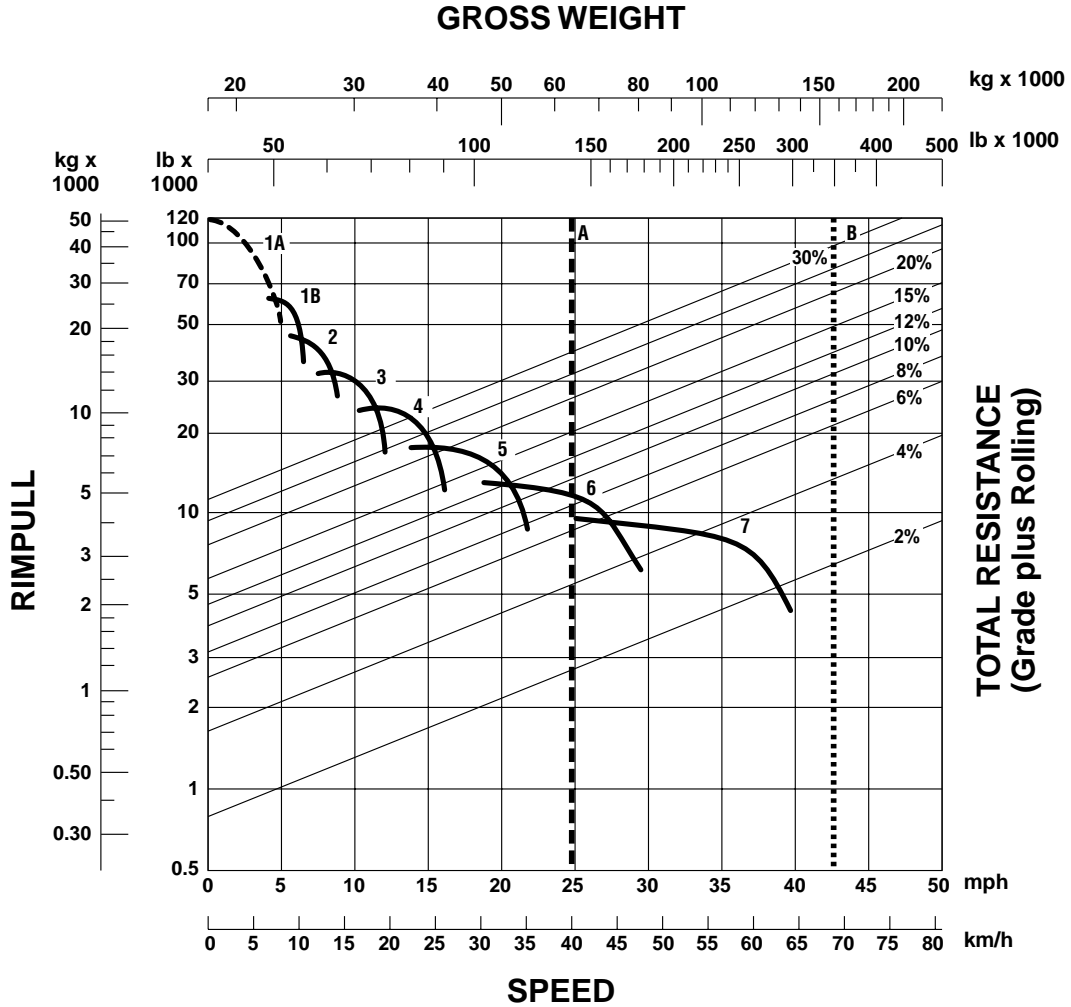

- KEY**
- 1A — 1st Gear (Torque Converter)
 - 1B — 1st Gear
 - 2 — 2nd Gear
 - 3 — 3rd Gear
 - 4 — 4th Gear
 - 5 — 5th Gear
 - 6 — 6th Gear
 - 7 — 7th Gear

- KEY**
- A* — Empty 64 359 kg (141,889 lb)
 - B* — Max GMW 161 028 kg (355,000 lb)
- *These two reference lines (A and B) apply only to 777D.

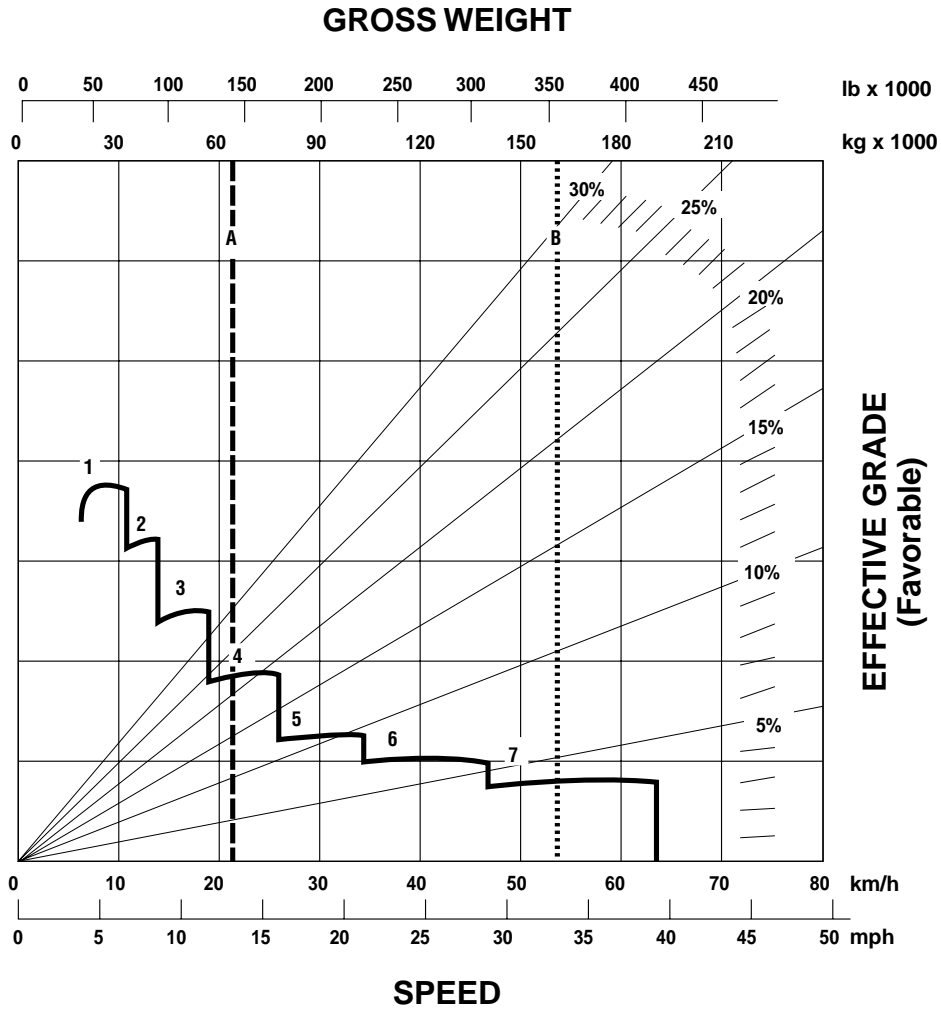

CONTINUOUS GRADE LENGTH

KEY

- 1 — 1st Gear
- 2 — 2nd Gear
- 3 — 3rd Gear
- 4 — 4th Gear
- 5 — 5th Gear
- 6 — 6th Gear
- 7 — 7th Gear

KEY

- A* — Empty 64 359 kg (141,889 lb)
- B* — Max GMW 161 028 kg (355,000 lb)

*These two reference lines (A and B) apply only to 777D. Brake performance for the 776D will vary depending on trailer brake capability.

777D, 776D Brake Performance
 ● 450 m (1500 ft) ● 600 m (2000 ft)
 ● 900 m (3000 ft) ● 1500 m (5000 ft)

Construction & Mining Trucks
 Construction & Mining Tractors

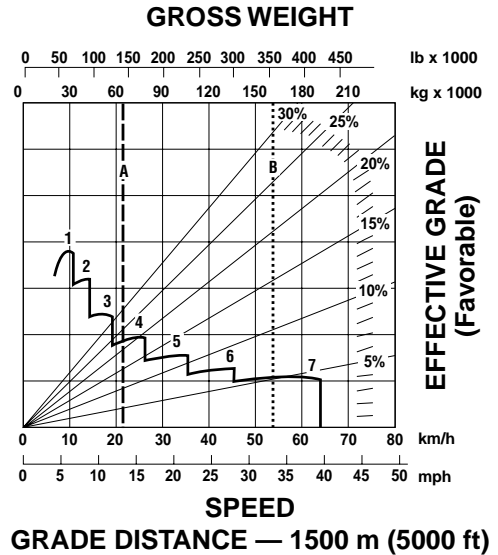
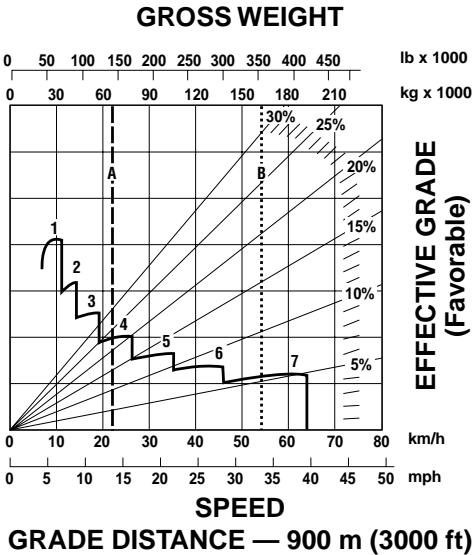
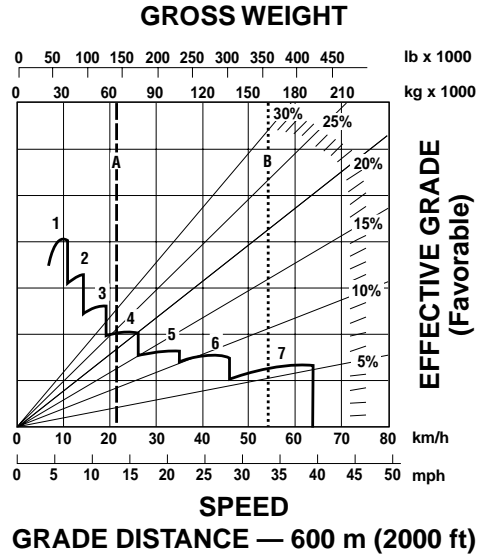
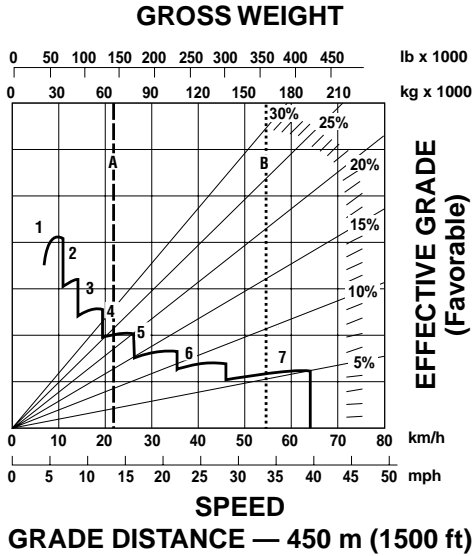

KEY

- 1 — 1st Gear
- 2 — 2nd Gear
- 3 — 3rd Gear
- 4 — 4th Gear
- 5 — 5th Gear
- 6 — 6th Gear
- 7 — 7th Gear

KEY

- A* — Empty 64 359 kg (141,889 lb)
- B* — Max GMW 161 028 kg (355,000 lb)

*These two reference lines (A and B) apply only to 777D. Brake performance for the 776D will vary depending on trailer brake capability.

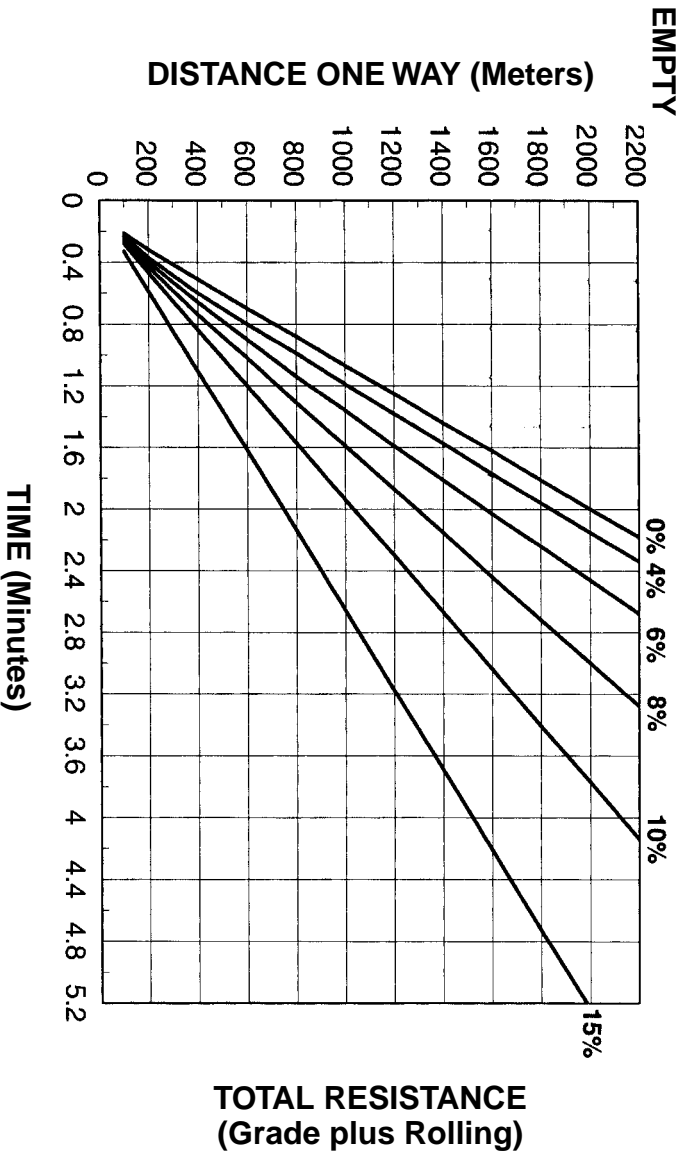
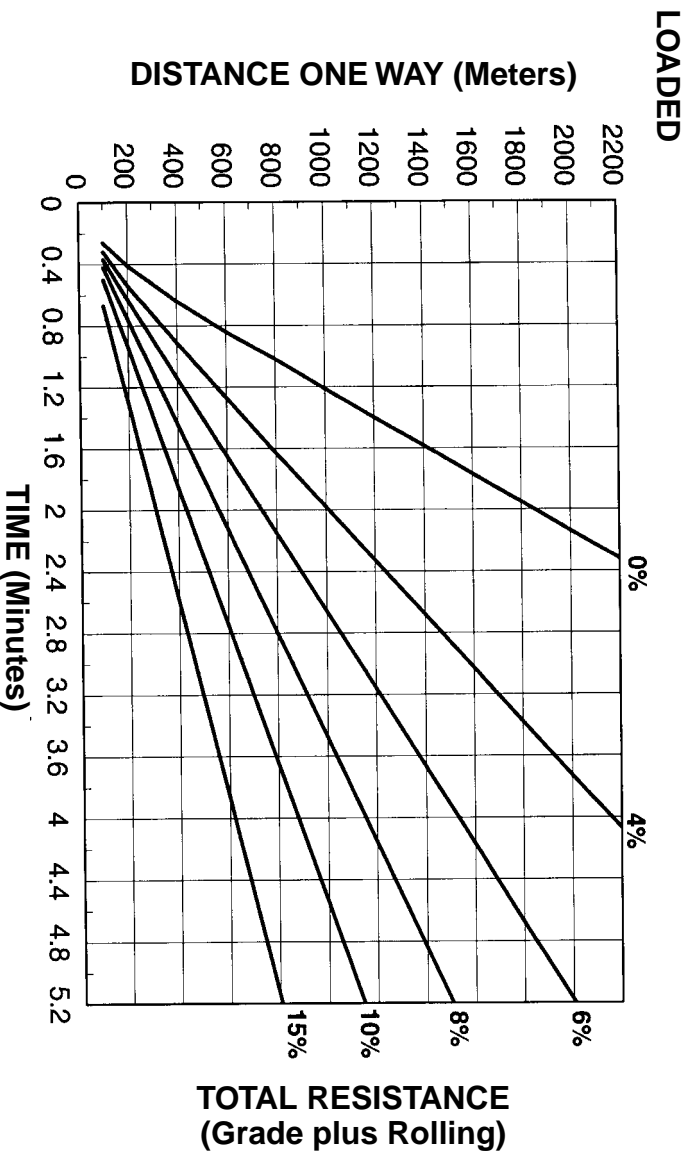

785C, 784C Rimpull-Speed-Gradeability
 • 33.00R51 Tires
 • 1433 mm (4'8.4") Tire Radius

Construction & Mining Trucks
Construction & Mining Tractors

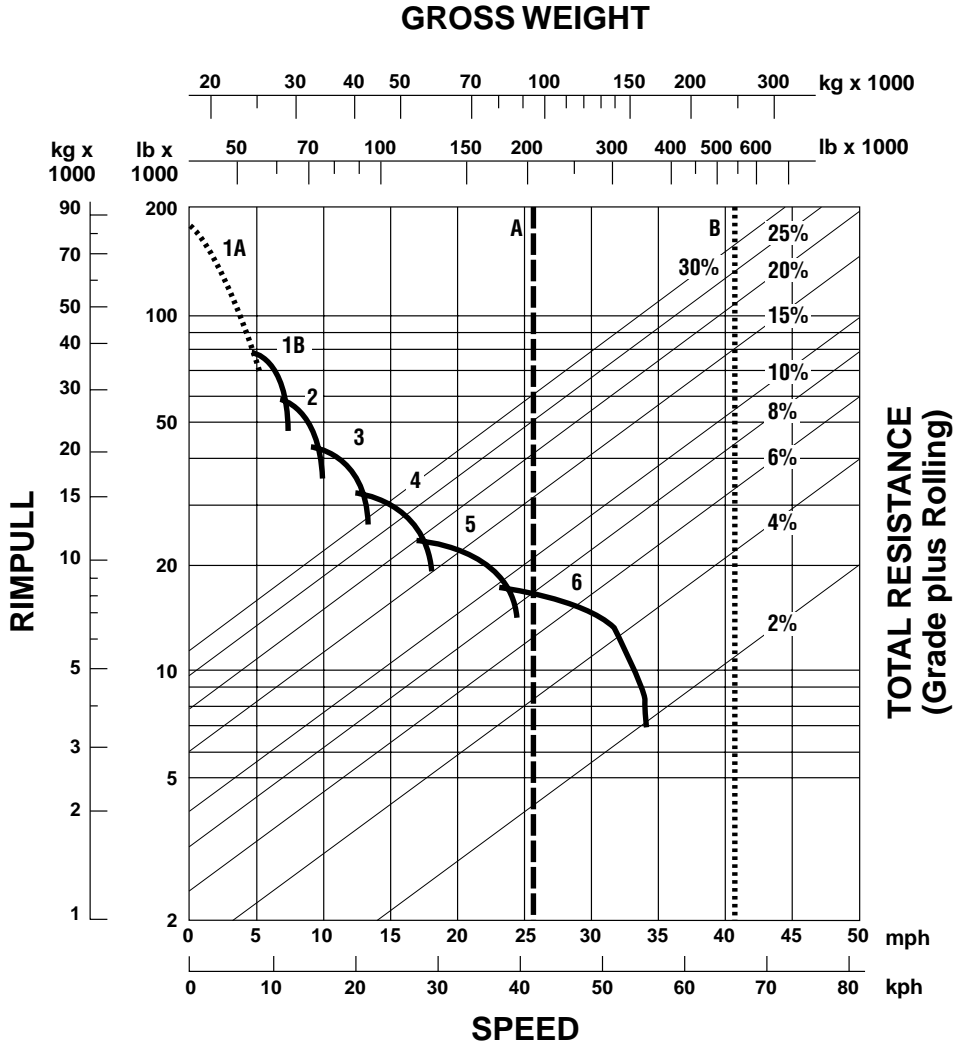

KEY

- 1A — 1st Gear (Torque Converter)
- 1B — 1st Gear
- 2 — 2nd Gear
- 3 — 3rd Gear
- 4 — 4th Gear
- 5 — 5th Gear
- 6 — 6th Gear

Maximum travel speeds

1900 rpm	Gear	km/h	MPH
Forward	1	12.1	7.5
	2	16.3	10.2
	3	22.2	13.8
	4	29.9	18.6
	5	40.6	25.2
	6	54.8	34.0
Reverse		11.0	6.8

KEY

- A* — Est. Field Empty Weight 113 400 kg (250,000 lb)**
- B* — Max GMW 249 433 kg (550,000 lb)

*These two reference lines (A and B) apply only to 785C.
 **Truck equipped with sideboards and liners.

Construction & Mining Trucks

784C Rimpull-Speed-Gradeability

- 36.00R51 Tires
- 1524 mm (5'0") Tire Radius

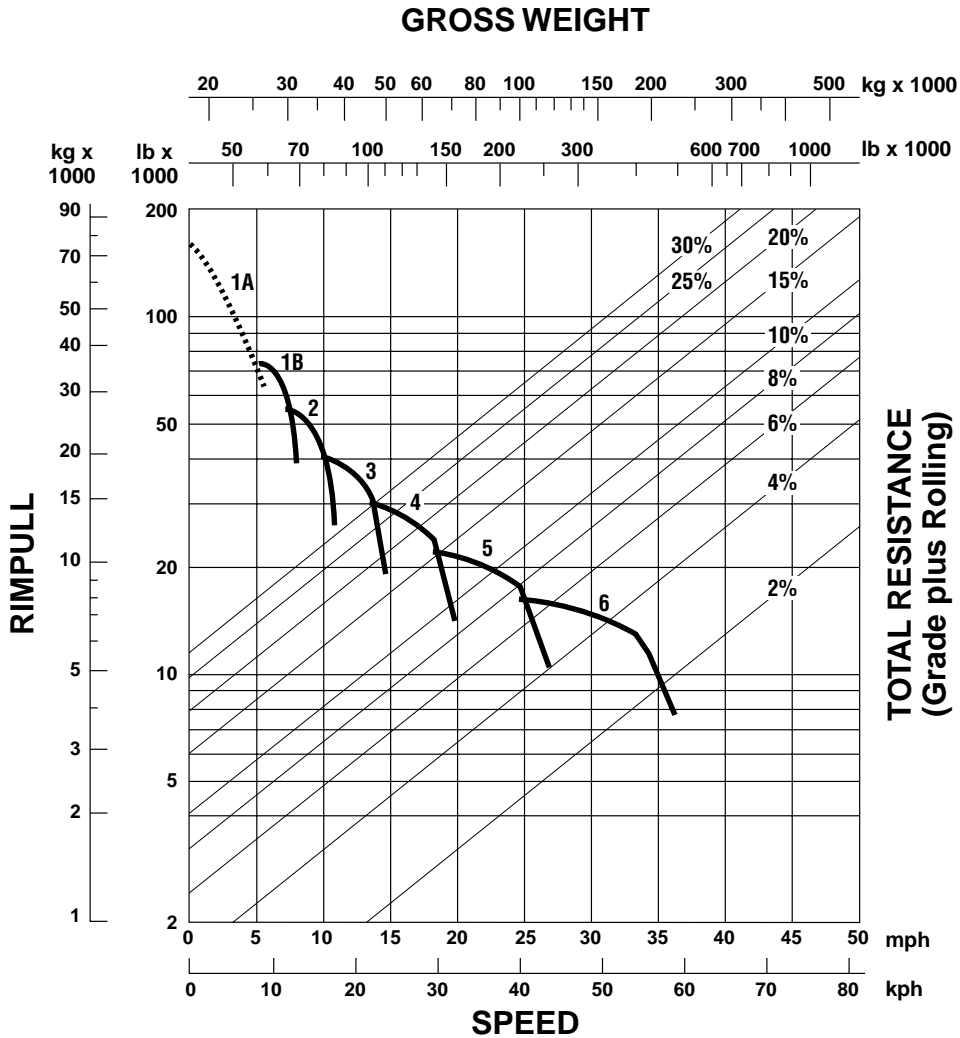

KEY

- 1A— 1st Gear (Torque Converter)
- 1B— 1st Gear
- 2 — 2nd Gear
- 3 — 3rd Gear
- 4 — 4th Gear
- 5 — 5th Gear
- 6 — 6th Gear

Maximum travel speeds

1900 rpm	Gear	km/h	MPH
Forward	1	12.9	8.0
	2	17.4	10.8
	3	23.5	14.6
	4	31.9	19.8
	5	43.3	26.8
	6	58.4	36.2
Reverse		11.7	7.2

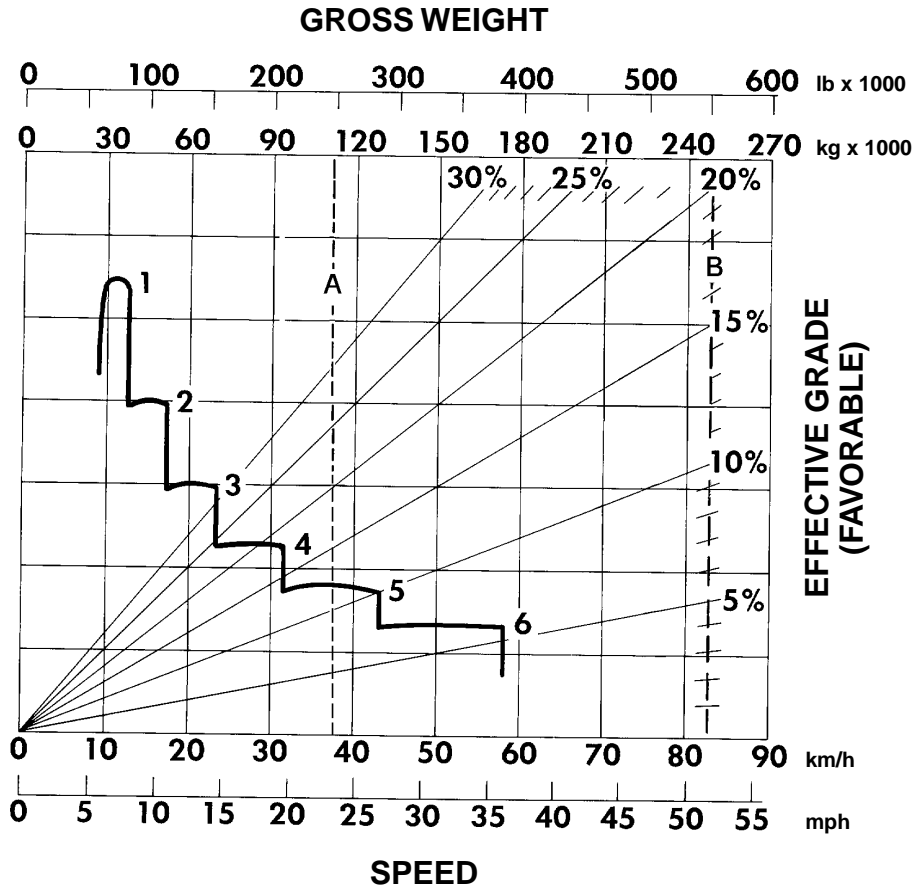

- KEY**
- 1 — 1st Gear
 - 2 — 2nd Gear
 - 3 — 3rd Gear
 - 4 — 4th Gear
 - 5 — 5th Gear
 - 6 — 6th Gear

- KEY**
- A* — Est. Field Empty Weight 113 400 kg (250,000 lb)**
 - B* — Max GMW 249 433 kg (550,000 lb)

*These two reference lines (A and B) apply only to 785C. Brake performance for 784C will vary depending on trailer brake capability.
 **Truck equipped with sideboards and liners.

**Construction & Mining Trucks
Construction & Mining Tractors**

785C, 784C Brake Performance

- 450 m (1500 ft)
- 600 m (2000 ft)
- 900 m (3000 ft)
- 1500 m (5000 ft)

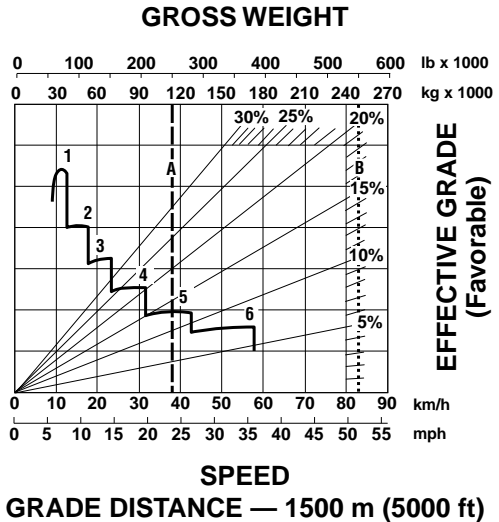
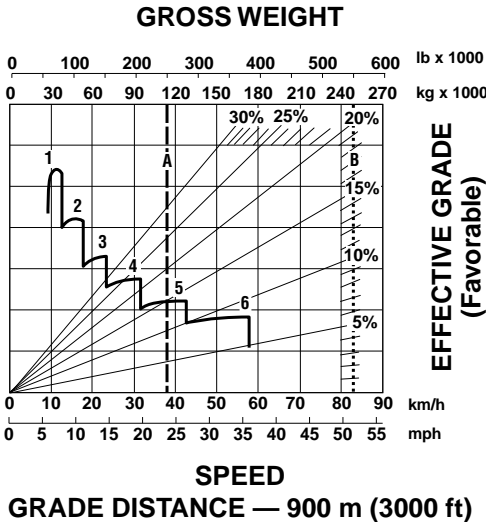
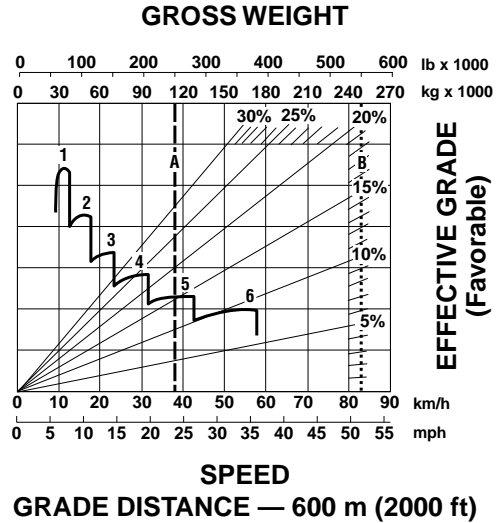
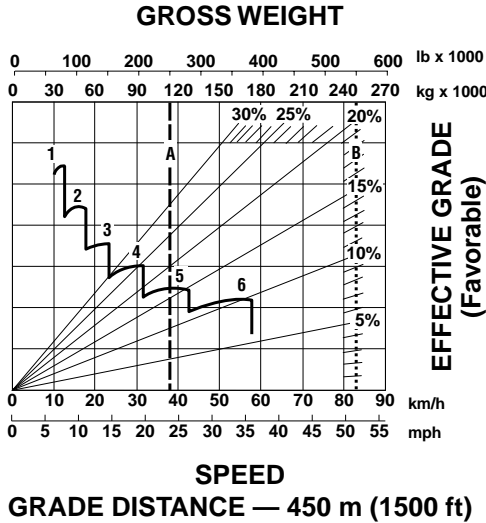

KEY

- 1 — 1st Gear
- 2 — 2nd Gear
- 3 — 3rd Gear
- 4 — 4th Gear
- 5 — 5th Gear
- 6 — 6th Gear

KEY

- A* — Est. Field Empty Weight 113 400 kg (250,000 lb)**
- B* — Max GMW 249 433 kg (550,000 lb)

*These two reference lines (A and B) apply only to 785C. Brake performance for 784C will vary depending on trailer brake capability.

**Truck equipped with sideboards and liners.

LOADED

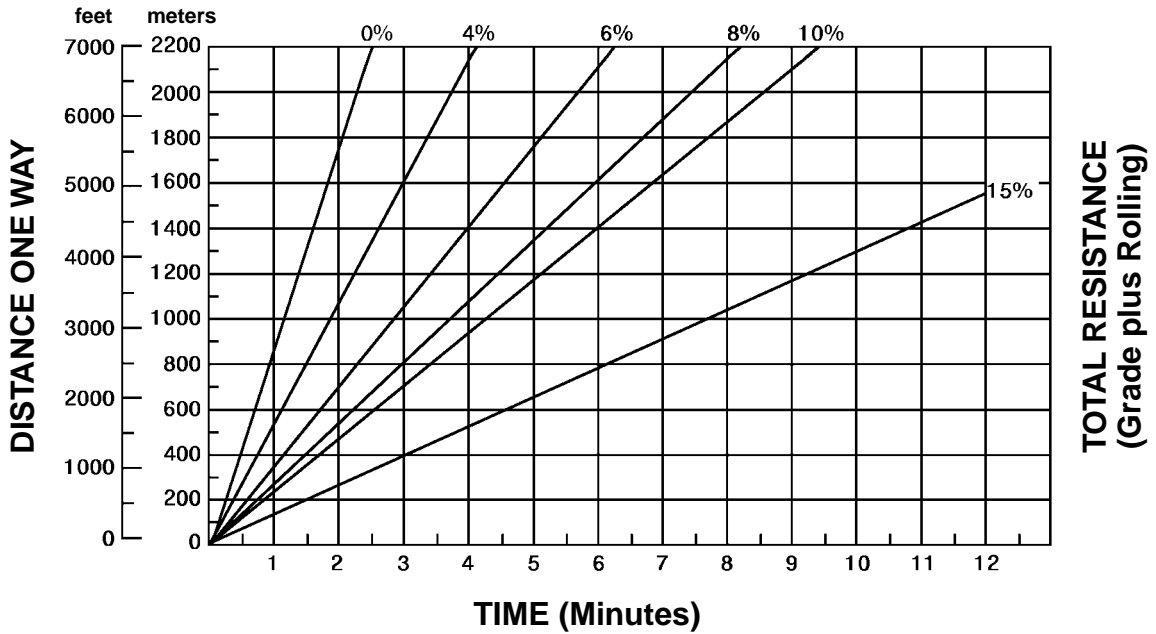

EMPTY

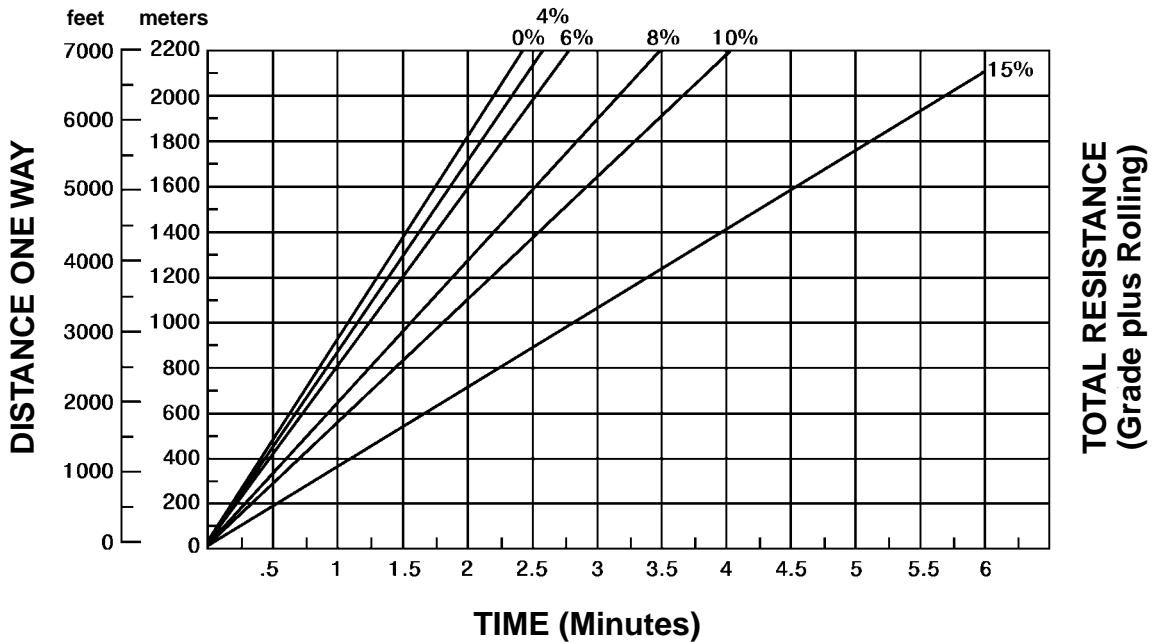

Construction & Mining Trucks

789C Rimpull-Speed-Gradeability

- 37.00R57 Tires
- 1593 mm (5'2.7") Tire Radius

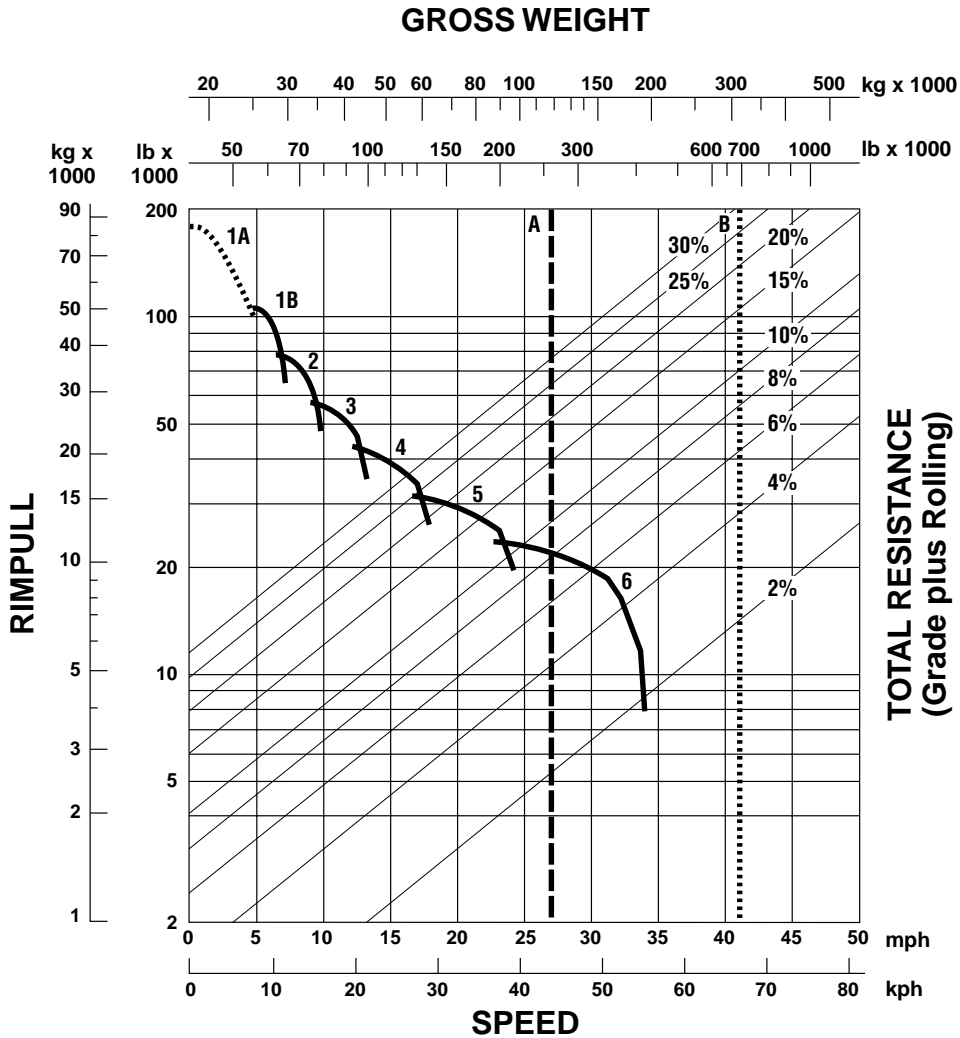

KEY

- 1A — 1st Gear (Torque Converter)
- 1B — 1st Gear
- 2 — 2nd Gear
- 3 — 3rd Gear
- 4 — 4th Gear
- 5 — 5th Gear
- 6 — 6th Gear

Maximum travel speeds

1900 rpm	Gear	km/h	MPH
Forward	1	12.0	7.5
	2	16.3	10.1
	3	22.0	13.7
	4	29.8	18.5
	5	40.4	25.0
	6	54.5	33.8
Reverse		10.9	6.8

KEY

- A — Est. Field Empty Weight 140 616 kg (310,000 lb)*
- B — Max GMW 317 460 kg (700,000 lb)

*Truck equipped with sideboards and liners.

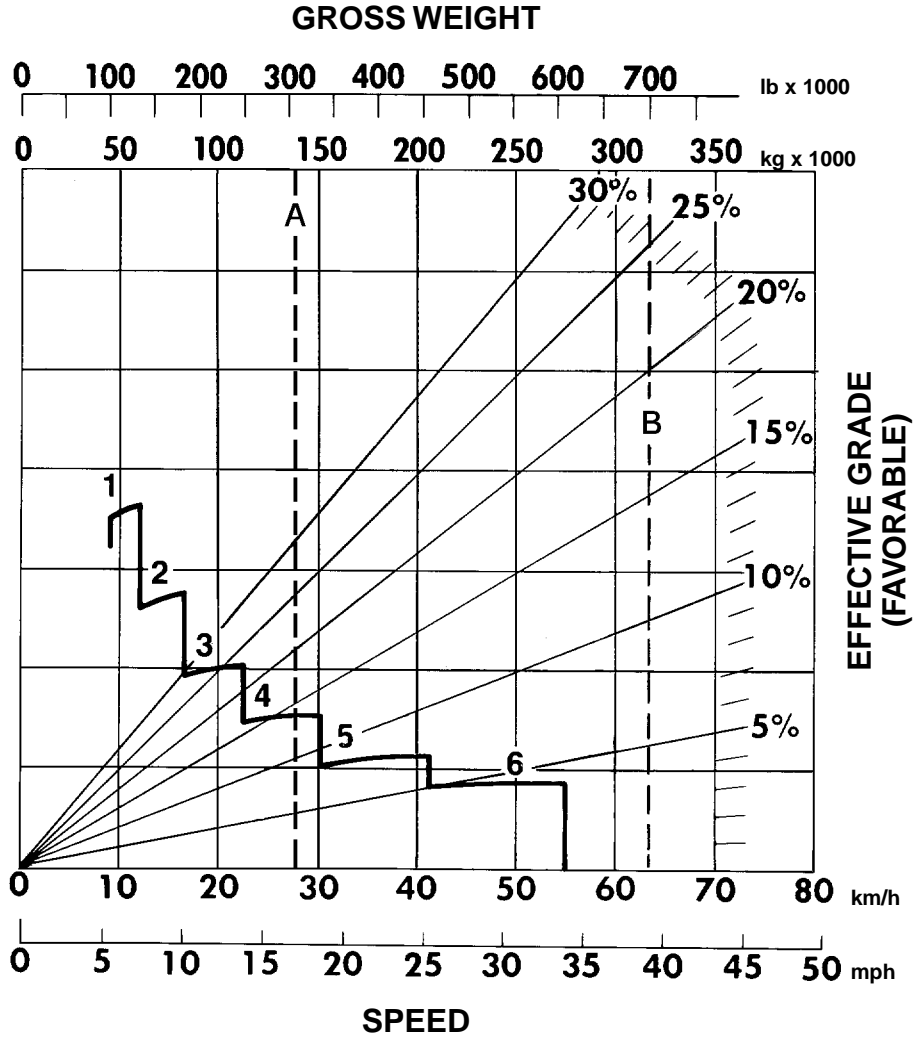

- KEY
- 1 — 1st Gear
 - 2 — 2nd Gear
 - 3 — 3rd Gear
 - 4 — 4th Gear
 - 5 — 5th Gear
 - 6 — 6th Gear

- KEY
- A — Est. Field Empty Weight 140 616 kg (310,000 lb)*
 - B — Max GMW 317 460 kg (700,000 lb)

*Truck equipped with sideboards and liners.

Construction & Mining Trucks

789C Brake Performance

- 450 m (1500 ft)
- 600 m (2000 ft)
- 900 m (3000 ft)
- 1500 m (5000 ft)

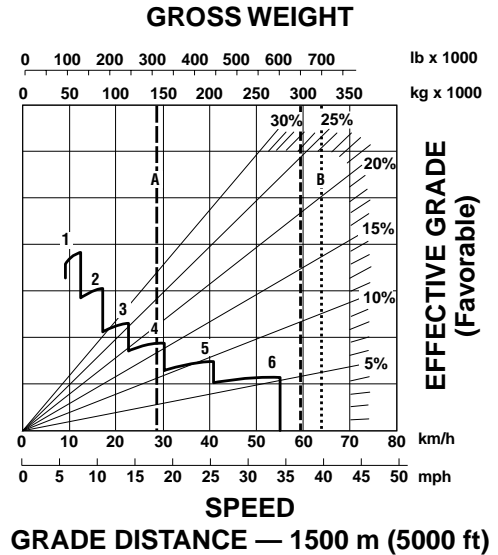
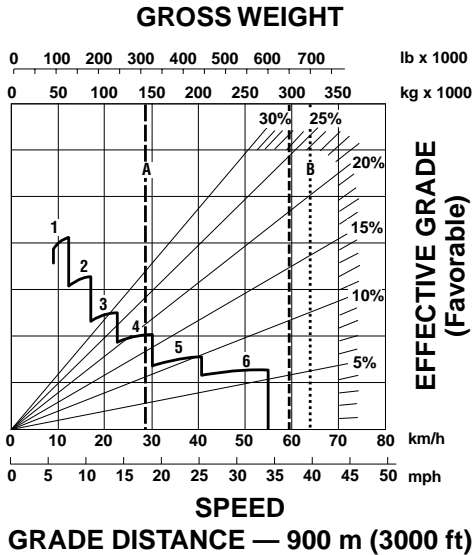
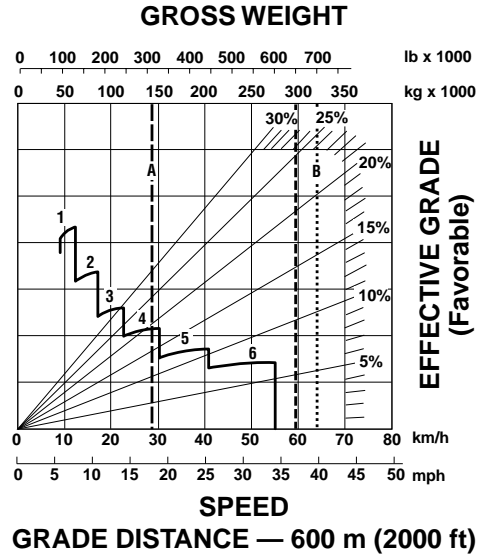
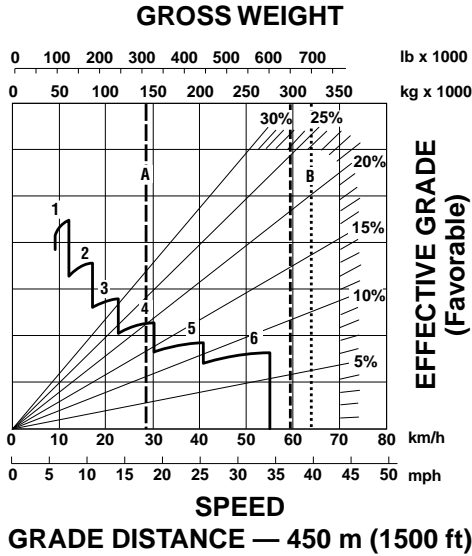

KEY

- 1 — 1st Gear
- 2 — 2nd Gear
- 3 — 3rd Gear
- 4 — 4th Gear
- 5 — 5th Gear
- 6 — 6th Gear

KEY

- A — Est. Field Empty Weight 140 616 kg (310,000 lb)*
- B — Max GMW 317 460 kg (700,000 lb)

*Truck equipped with sideboards and liners.

LOADED

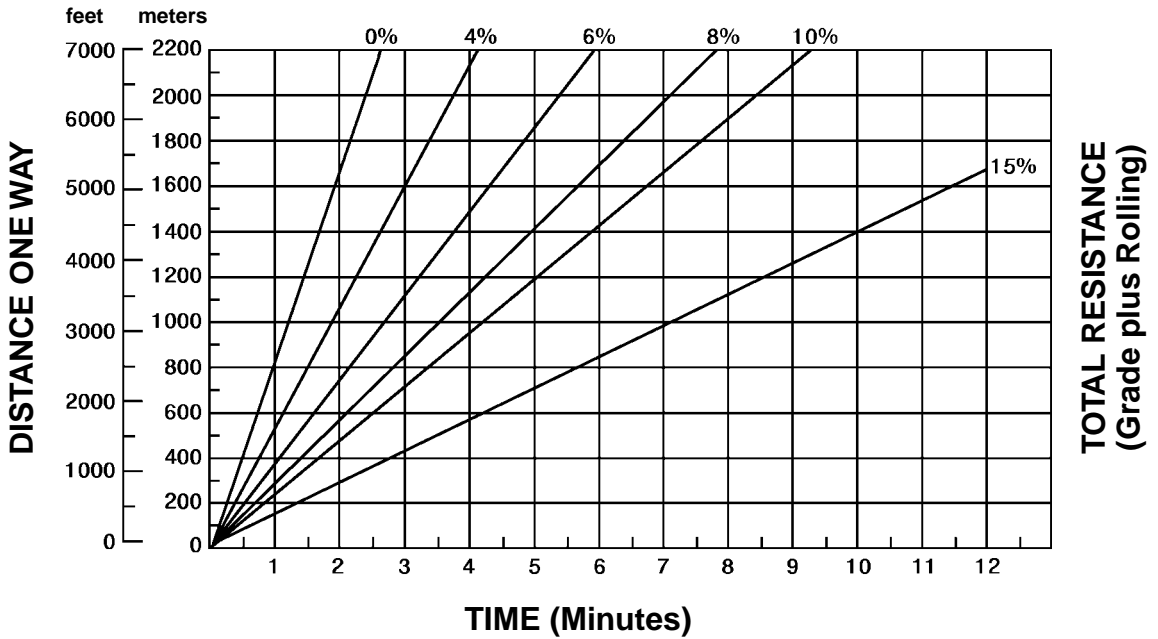

EMPTY

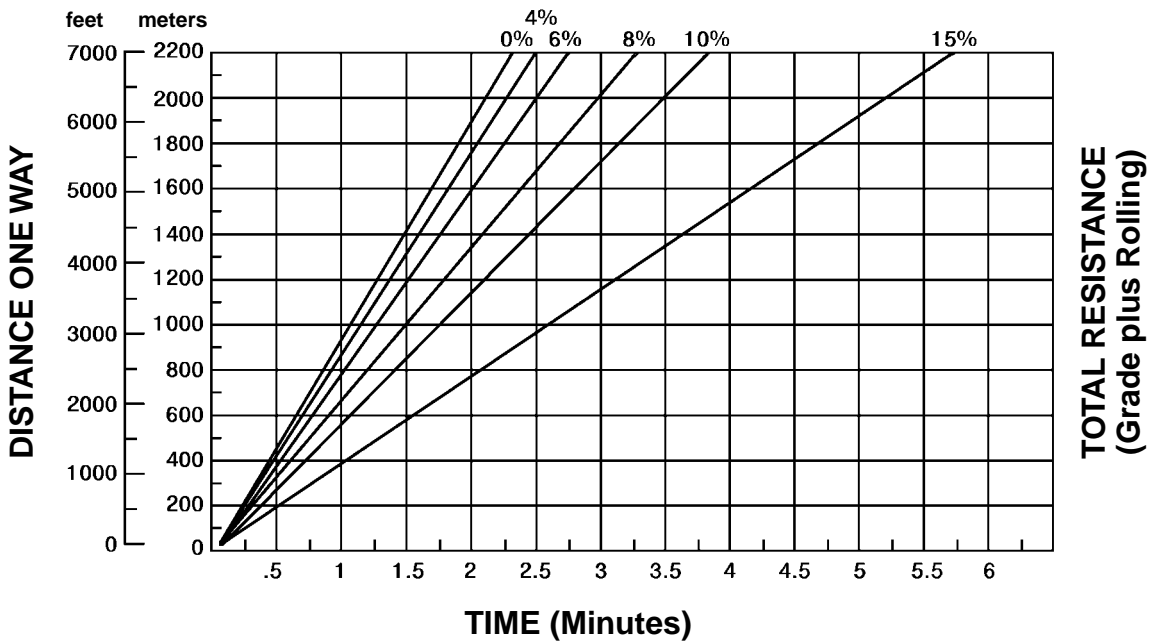

- 40.00R57 Tires
- 1778 mm (5'10") Tire Radius

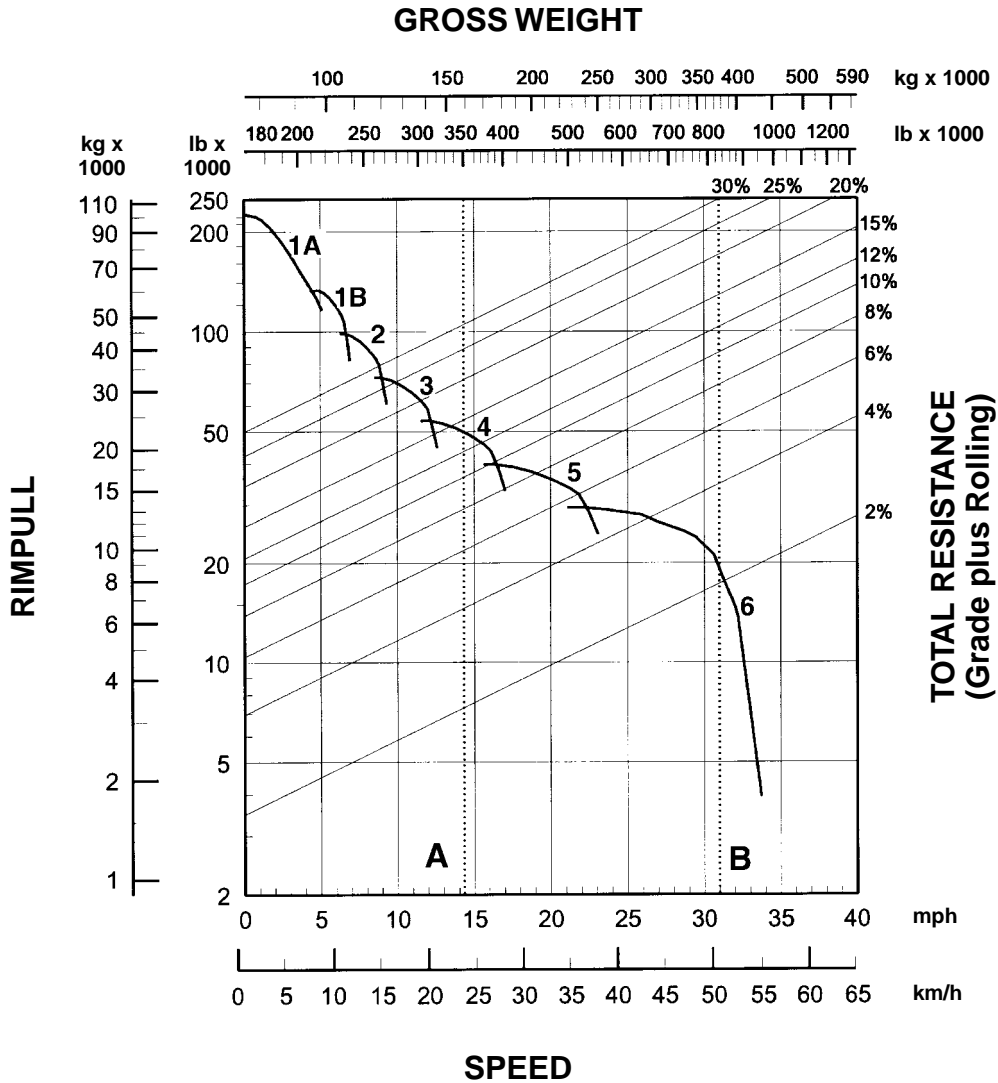

KEY

- 1A— 1st Gear (Torque Converter)
- 1B— 1st Gear
- 2 — 2nd Gear
- 3 — 3rd Gear
- 4 — 4th Gear
- 5 — 5th Gear
- 6 — 6th Gear

KEY

- A — Est. Field Empty Weight 158 760 kg (350,000 lb)*
- B — Max GMW 376 488 kg (830,000 lb)

*Truck equipped with sideboards and liners.

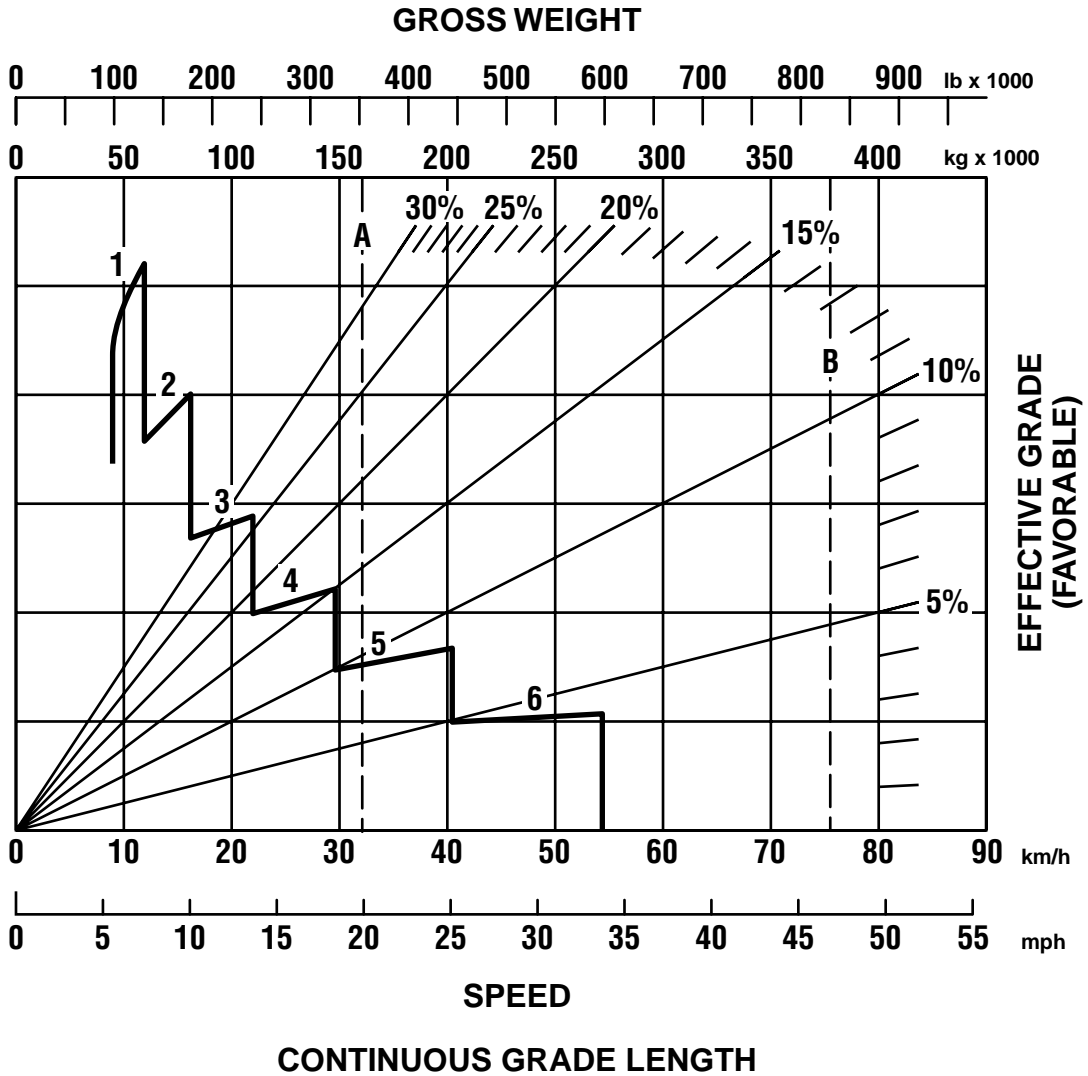

- KEY**
- 1 — 1st Gear
 - 2 — 2nd Gear
 - 3 — 3rd Gear
 - 4 — 4th Gear
 - 5 — 5th Gear
 - 6 — 6th Gear

- KEY**
- A — Est. Field Empty Weight 158 760 kg (350,000 lb)*
 - B — Max GMW 376 488 kg (830,000 lb)

*Truck equipped with sideboards and liners.

Construction & Mining Trucks

793C Brake Performance

- 450 m (1500 ft)
- 600 m (2000 ft)
- 900 m (3000 ft)
- 1500 m (5000 ft)

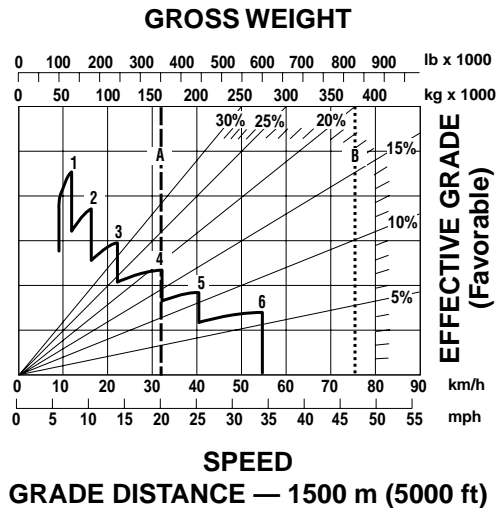
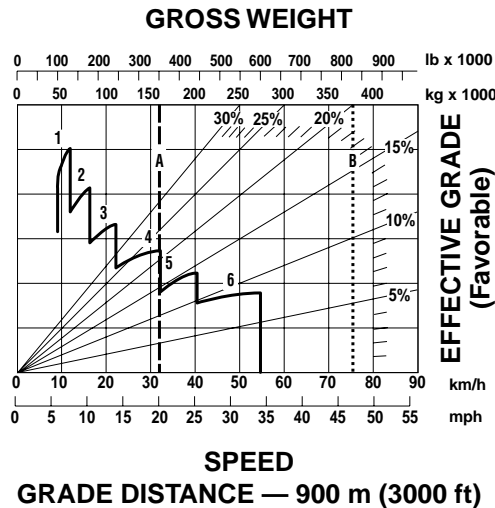
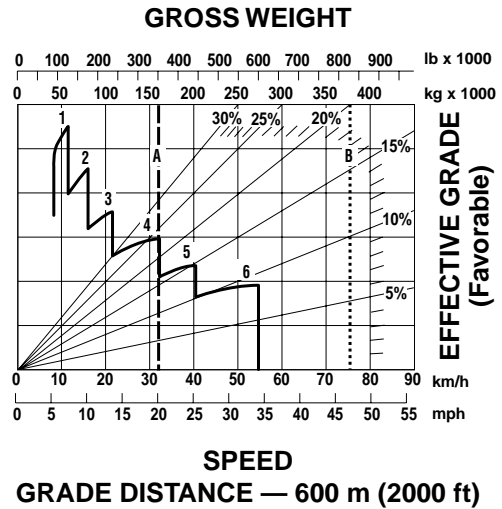
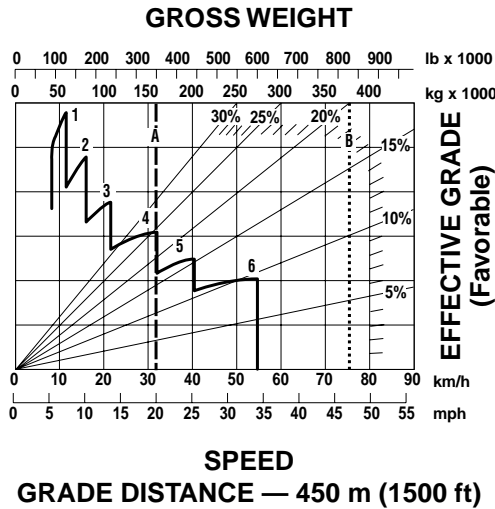

KEY

- 1 — 1st Gear
- 2 — 2nd Gear
- 3 — 3rd Gear
- 4 — 4th Gear
- 5 — 5th Gear
- 6 — 6th Gear

KEY

- A — Est. Field Empty Weight 158 760 kg (350,000 lb)*
- B — Max GMW 376 488 kg (830,000 lb)

*Truck equipped with sideboards and liners.

LOADED

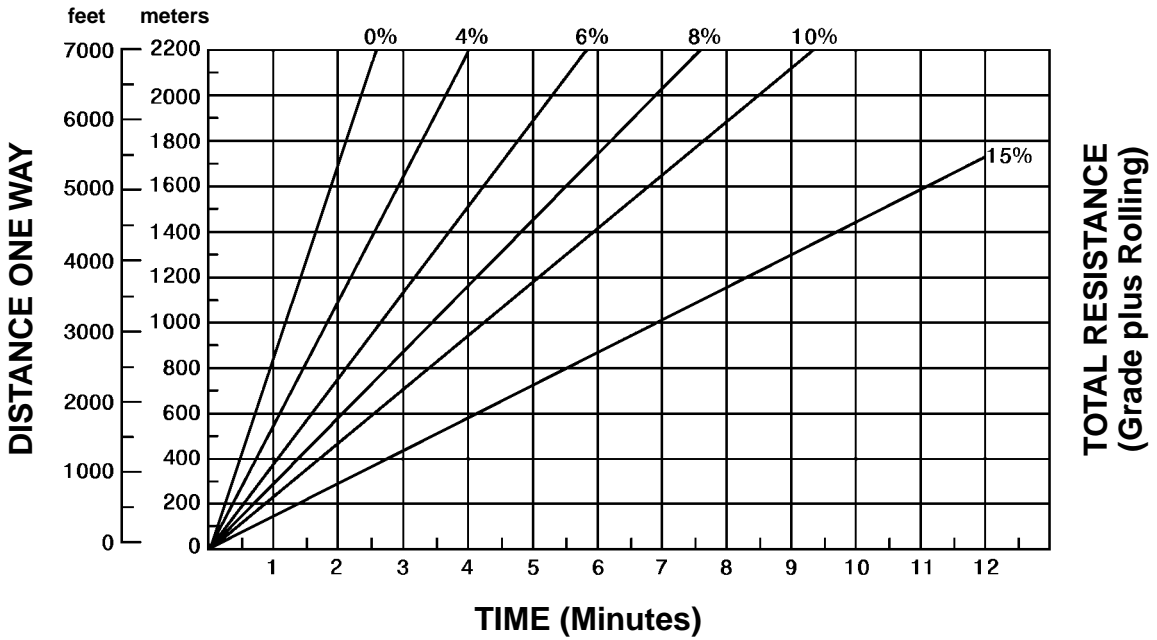

EMPTY

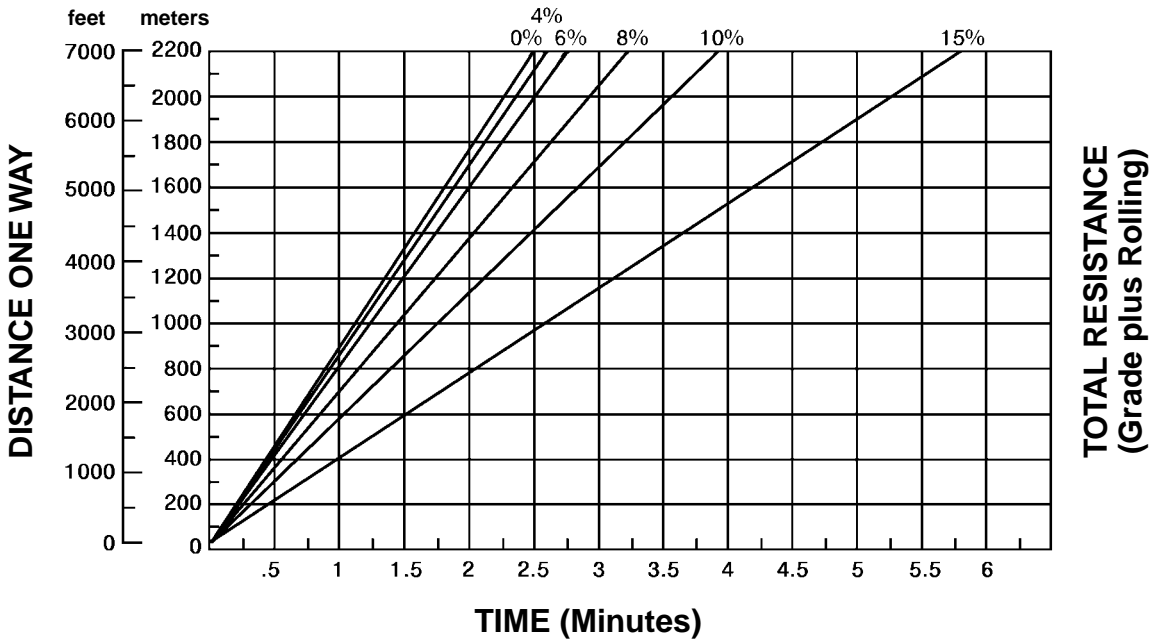

ARTICULATED TRUCKS

CONTENTS

Features	10-1
Specifications	10-2
Special Arrangements	10-4
Ground Pressure	10-5
Curves:	
D25D Brake/Retarder Performance Curve, Rimpull, Travel Time (loaded and empty)	10-8
D30D Brake/Retarder Performance Curve, Rimpull, Travel Time (loaded and empty)	10-11
D250E Series II Brake/Retarder Performance Curve, Rimpull, Travel Time (loaded and empty)	10-14
D300E Series II Brake/Retarder Performance Curve, Rimpull, Travel Time (loaded and empty)	10-17
D350E Retarding Performance Curve, Rimpull, Travel Time (loaded and empty)	10-23
D400E Brake/Retarder Performance Curve, Rimpull, Travel Time (loaded and empty)	10-26

Features:

- **Caterpillar four-stroke-cycle diesels** ... turbo-charged and aftercooled, automatic variable timing ... parallel porting ... direct injection, adjustment-free fuel system ... meet all environment regulations effective January 1, 1996.
- **Electronically programmable transmission control on “E” series models** ... speed sensing device automatically shifts transmission between 1st and gear selected by operator. Control constantly monitors transmission behavior for quick and efficient troubleshooting.
- **Articulating and fully oscillating hitch** ... links torsion-free front and rear frames for exceptional maneuverability and traction on uneven terrain. Cast hitch head is robotically-welded to steel alloy forged tube for unmatched strength and durability.
- **Superior suspension systems** ... coupled with oscillating hitch, provide smooth ride and excellent traction for prime performance and operator comfort.
- **Wide, long, low dump body design** ... for enhanced loadability, material retention and ejection, with excellent machine stability. Low load-over-height allows versatile loader match.
- **High capacity low pressure tires in single formation** ... for superior traction and flotation on poor underfoot conditions.
- **High power-to-weight ratio and excellent gradeability** ... for high-efficiency and versatile performance.
- **Standard ROPS/FOPS, low sound level cab with tinted safety glass** ... for productive and safe operation.



MODEL	D25D		D30D	
Flywheel Power	194 kW	260 hp	213 kW	285 hp
Operating Weight (Empty)*	19 450 kg	42,880 lb	21 690 kg	47,320 lb
Top Speed (Loaded)	48 km/h	30 mph	52 km/h	32 mph
GMW — Gross Machine Weight	42 250 kg	93,145 lb	49 150 kg	108,360 lb
Distribution Empty:				
Front		70%		66%
Rear		30%		34%
Distribution Loaded:				
Front		48%		44%
Rear		52%		56%
Max. Capacity**	22.7 t	25 T	27.2 t	30 T
Struck (SAE)	10 m ³	13 yd³	12.5 m ³	16.4 yd³
Heaped (2:1) (SAE)	14 m ³	18 yd³	16.5 m ³	21.6 yd³
Engine Model	3306TA		3306TA	
No. Cylinders	6		6	
Bore	121 mm	4.75"	121 mm	4.75"
Stroke	152 mm	6"	152 mm	6"
Displacement	10.5 L	638 in³	10.5 L	638 in³
Tires, Front & Rear	26.5R25 Radials		29.5R25 Radials	
Circular Clearance				
Diameter	15.9 m	52'2"	16.4 m	53'9"
Fuel Tank Refill Capacity	450 L	120 U.S. gal	450 L	120 U.S. gal
GENERAL DIMENSIONS (Empty):				
Height to Cab Top	3.34 m	10'11"	3.40 m	11'2"
Wheel Base	4.93 m	16'2"	5.04 m	16'6"
Overall Length	8.79 m	28'10"	8.89 m	29'2"
Loading Height (Empty)	2.63 m	8'8"	2.83 m	9'3"
Height at Full Dump	5.19 m	17'0"	5.46 m	17'11"
Body Length	4.79 m	15'8"	4.90 m	16'1"
Width (Operating)	3.00 m	9'10"	3.30 m	10'10"
Front Tire Tread	2.32 m	7'7"	2.55 m	8'4"

*Includes coolant, lubricant and full fuel tank.

**Rating dependent on optional equipment. Maximum gross weight (empty weight plus payload) should not be exceeded.

Specifications
• Three-Axle Models

Articulated Trucks



MODEL	D250E Series II		D300E Series II		D350E		D400E	
Flywheel Power	201 kW	270 hp	213 kW	285 hp	253 kW	340 hp	302 kW	405 hp
Operating Weight (Empty)*	21 600 kg	47,630 lb	22 450 kg	49,500 lb	27 871 kg	61,455 lb	29 263 kg	64,510 lb
Top Speed (Loaded)	50.9 km/h	31.6 mph	49 km/h	30.5 mph	50.7 km/h	31.5 mph	55.4 km/h	34 mph
GMW — Gross Machine Weight	44 280 kg	97,640 lb	49 670 kg	109,520 lb	59 631 kg	131,486 lb	65 563 kg	144,500 lb
Distribution Empty:								
Front		56%		54%		60%		60%
Center		23%		24%		20%		20%
Rear		21%		22%		20%		20%
Distribution Loaded:								
Front		30%		30%		35%		34%
Center		35%		35%		33%		33%
Rear		35%		35%		32%		33%
Max. Capacity**	22.7 t	25 T	27.2 t	30 T	31.8 t	35 T	36.3 t	40 T
Struck (SAE)	10.5 m ³	13.7 yd³	13 m ³	17 yd³	14.6 m ³	19.1 yd³	16.5 m ³	21.6 yd³
Heaped (2:1) (SAE)	13.7 m ³	18 yd³	16.5 m ³	21.6 yd³	19.2 m ³	25.1 yd³	22 m ³	28.8 yd³
Engine Model	3306DITA		3306DITA		3406DITA		3406DITA	
No. Cylinders	6		6		6		6	
Bore	121 mm	4.75"	121 mm	4.75"	137 mm	5.4"	137 mm	5.4"
Stroke	152 mm	6"	152 mm	6"	165 mm	6.5"	165 mm	6.5"
Displacement	10.5 L	638 in³	10.5 L	638 in³	14.6 L	893 in³	14.6 L	893 in³
Tires, Front, Center & Rear	23.5R25 Radials		23.5R25 Radials		26.5R25 Radials		29.5R25 Radials	
Circle Clearance Diameter	14.9 m	48'10"	15.2 m	49'8"	16.42 m	53'10"	16.5 m	54'3"
Fuel Tank Refill Capacity	360 L	95 U.S. gal	360 L	95 U.S. gal	570 L	154 U.S. gal	570 L	154 U.S. gal
GENERAL DIMENSIONS (Empty):								
Height to Cab Top	3.35 m	11'0"	3.35 m	11'0"	3.51 m	11'6"	3.58 m	11'9"
Wheel Base (Front-Center of Bogie)	4.72 m	15'6"	4.72 m	15'6"	5.02 m	16'6"	5.12 m	16'10"
Overall Length	9.99 m	32'9"	9.99 m	32'9"	10.38 m	34'1"	10.52 m	34'6"
Loading Height (Empty)	2.75 m	9'0"	2.89 m	9'6"	2.94 m	9'8"	3.06 m	10'1"
Height at Full Dump	6.40 m	21'0"	6.44 m	21'2"	6.60 m	21'8"	6.58 m	21'7"
Body Length	5.80 m	19'0"	5.80 m	19'0"	6.01 m	19'9"	5.90 m	19'4"
Width (Operating)	2.88 m	9'5"	2.91 m	9'7"	3.26 m	10'8"	3.30 m	10'10"
Front Tire Tread	2.22 m	7'3"	2.30 m	7'7"	2.55 m	8'4"	2.55 m	8'4"

*Includes coolant, lubricant and full fuel tank.

**Rating dependent on optional equipment. Maximum gross weight (empty weight plus payload) should not be exceeded.

A variety of special arrangements are available on a custom product basis. Below is a summary of some of the most popular versions, which are attainable in different model sizes. Please contact your Caterpillar dealer for details and availability.

Refuse Haulers — Very large capacity body arrangements for transport of bulk solid waste, normally used between a transfer station and the face of a sanitary landfill. Arrangement includes large capacity body, extended rear frame and scissors tailgate.

Hydraulically operated steel covers — Available for certain refuse bodies. The covers improve light material retention during transport.

Container Carriers — Allows transport and dump of 6 m (20'0") ISO containers. Usual application is handling containerized waste in landfills. Arrangement includes an extended and reinforced rear frame combined with a special tipping structure.

Transverse Steering — Improves maneuverability in areas with limited space, like tunnels, underground mines and industrial sites. This option allows the truck to turn completely around in a space slightly longer than the truck itself. Available for two axle trucks only.

Heavy Duty Bodies — More robust bodies made with thicker plates and incorporating rock deflectors for tire protection. Increase the vehicle's material appetite and provide longer life in applications involving highly abrasive materials and high impact loading.

Extended Chassis/Water Wagons — Long wheel base chassis, suitable for installation of low center of gravity liquid tanks and other AEM accessories. The extended rear frame permits use of low center of gravity arrangements for added stability. Common applications are haul road dust control and off-road transport of water or fuel. Available for three axle trucks only.

Coal Haulers — Machines configured with large capacity body, extended rear frame and scissors tailgate, for transport of coal. The longer frame helps maintain stability and gives loading height accessible to many loading systems.

Sugar Cane Haulers — May be manufactured by using extended rear frame chassis, adding a sub frame and special tires.

Model	D25D	D30D	D250E	D300E	D350E	D400E
Refuse Haulers			X	X	X	X
Container Carriers			X	X		
Transverse Steer	X	X				
Heavy Duty Bodies	X	X				
Extended Chassis			X	X	X	X
Coal Haulers				X	X	X
Sugar Cane Haulers				X		

Use of Ground Pressure Charts

Articulated trucks are normally equipped with wide base radial tires, for improved flotation in poor underfoot conditions. Ground pressure is a function of tire deflection and is also affected by tire penetration. The charts in this section provide a means to estimate ground pressure for 0 and 76 mm (3") tire penetration, when gross vehicle weight, axle load distribution and tire inflation pressure are known. The ground pressure charts on the following pages are based on Michelin XADN tire characteristics. Results may differ for other tread patterns.

Tire load can be calculated by the following formula:

$$\text{Tire load} = \frac{\text{Heaviest Axle Load}}{2}$$

Example

Find the ground pressure generated by a D250E fully loaded with zero and 76 mm (3") tire penetration. The machine is equipped with standard Michelin 23.5R25 tires, inflated to the recommended pressure.

$$\text{D250E Tire Load} = \frac{43\,680 \text{ kg} \times 0.34}{2} = 7426 \text{ kg}$$

$$\text{D250E Tire Load} = \frac{96,300 \text{ lb} \times 0.34}{2} = 16,371 \text{ lb}$$

From the tire section in this book, inflation pressure for the D250E is 325 kPa = 3.25 bar (47 psi).

From the ground pressure chart for 23.5R25 tires, Ground pressure = 3.1 kg/cm² (44 psi) with zero tire penetration.

Ground pressure = 1.4 kg/cm² (21 psi) with 76 mm (3 in) tire penetration.

See the Wheel Tractor Scraper section for explanation on using:

- Rimpull-Speed-Gradeability Curves
- Retarder Curves
- Travel Time Charts

See the Construction and Mining Trucks section for Hauling Unit Fixed Times.

23.5R25 Tires*

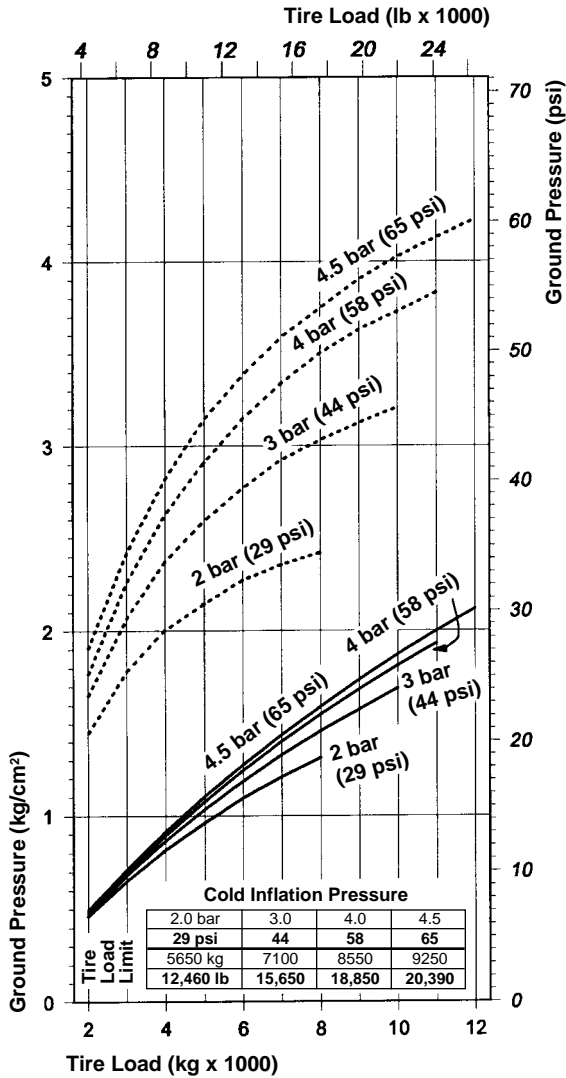

30/65R25 Tires*

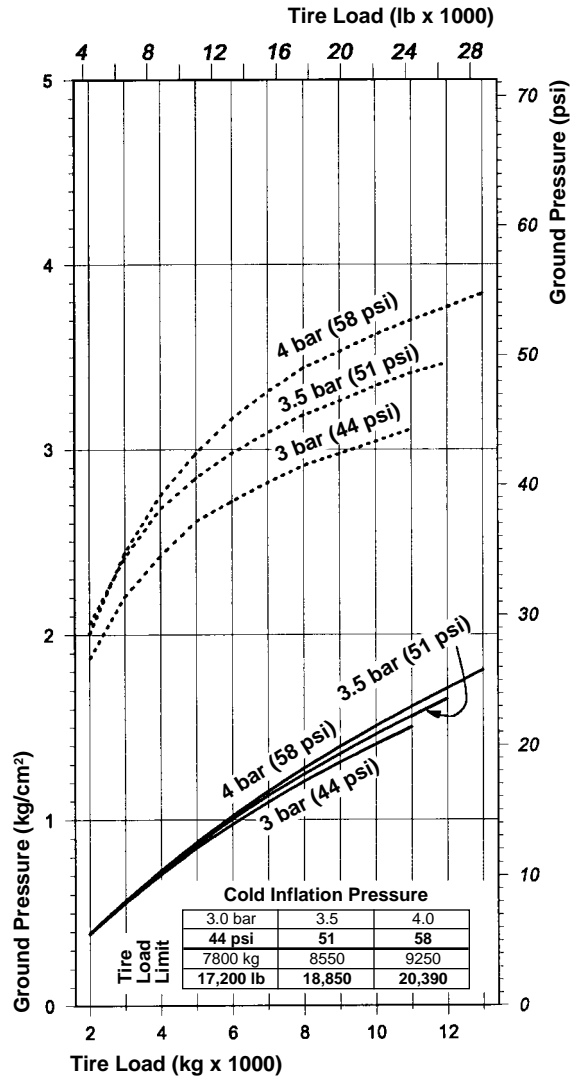

KEY
 ----- Zero Penetration (Flat Plate)
 _____ 76 mm (3") Penetration

*Charts based on Michelin XADN tire characteristics. Results may differ for other tread patterns and/or brands. Charts are to be used to calculate ground pressure. To determine the inflation as a function of load and conditions or when loads exceed tire load limit, contact your tire manufacturer representative.

26.5R25 Tires*

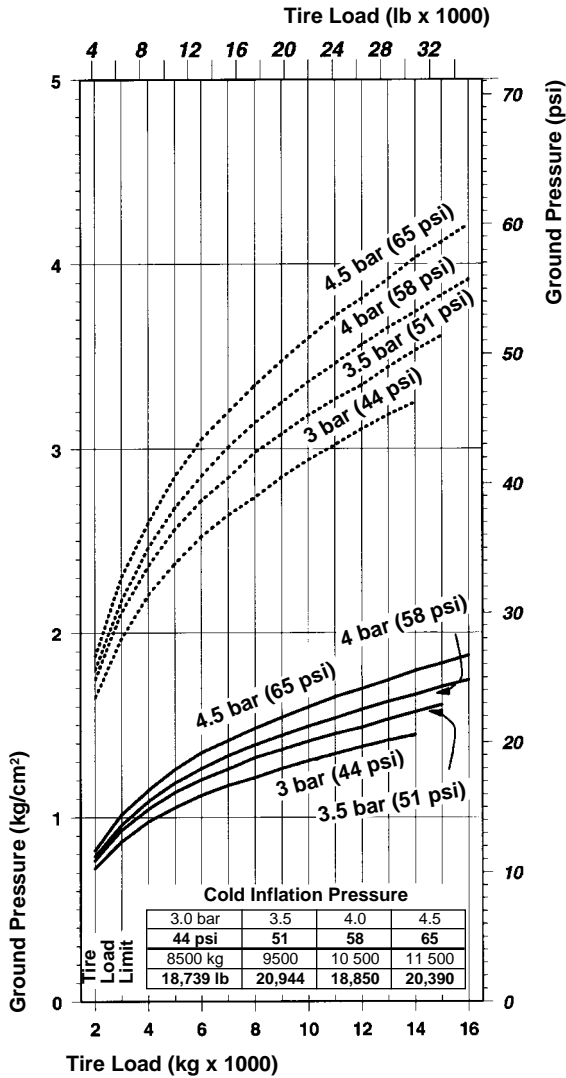

29.5R25 Tires*

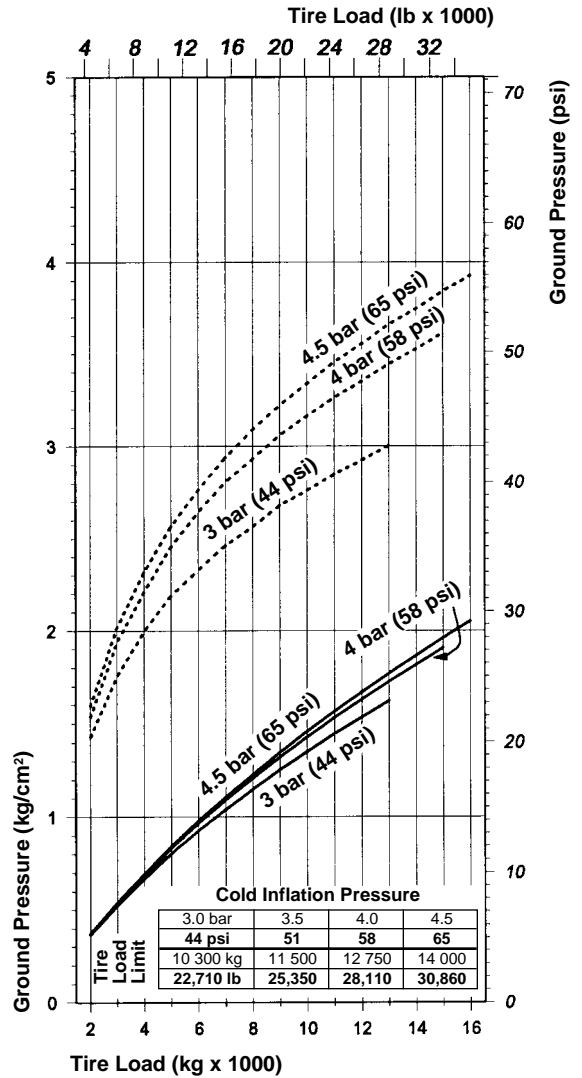

10

KEY

- Zero Penetration (Flat Plate)
- 76 mm (3") Penetration

*Charts based on Michelin XADN tire characteristics. Results may differ for other tread patterns and/or brands. Charts are to be used to calculate ground pressure. To determine the inflation as a function of load and conditions or when loads exceed tire load limit, contact your tire manufacturer representative.

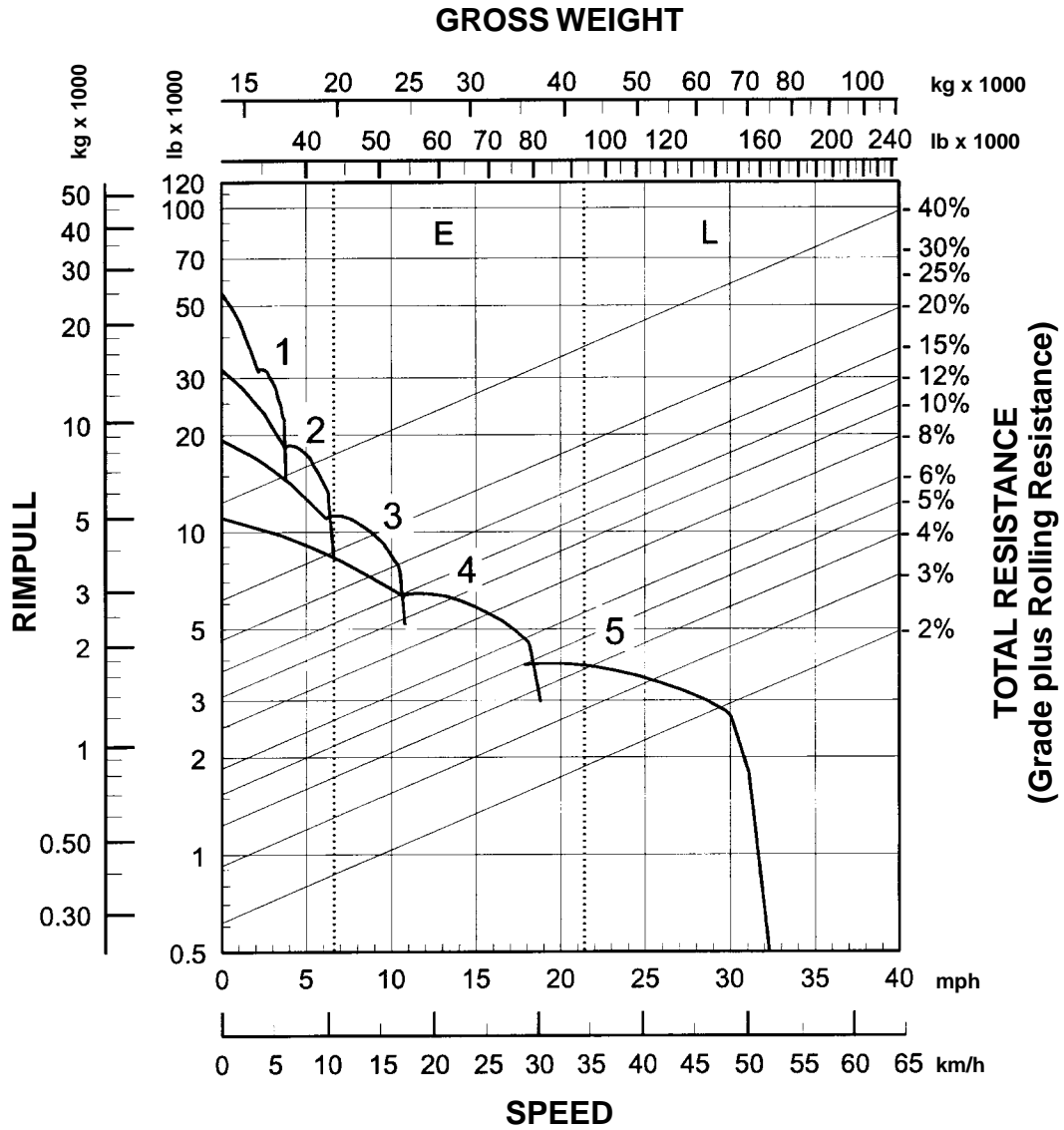

- KEY**
- 1 — 1st Gear
 - 2 — 2nd Gear
 - 3 — 3rd Gear
 - 4 — 4th Gear
 - 5 — 5th Gear

- KEY**
- E — Empty 19 700 kg (43,428 lb)
 - L — Loaded 42 381 kg (93,428 lb)

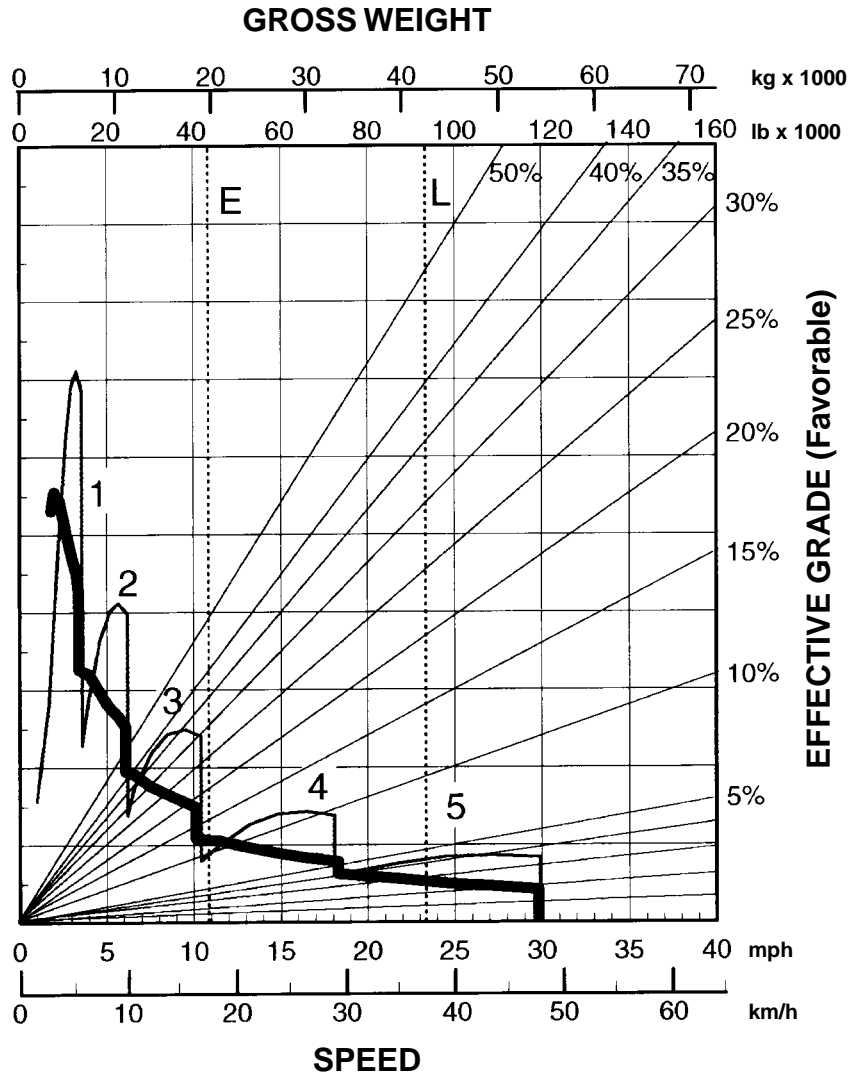

—— 200 m (660 ft) OR LESS GRADE LENGTH
 ——— CONTINUOUS

- KEY
- 1 — 1st Gear
 - 2 — 2nd Gear
 - 3 — 3rd Gear
 - 4 — 4th Gear
 - 5 — 5th Gear

- KEY
- E — Empty 19 700 kg (43,428 lb)
 - L — Loaded 42 381 kg (93,428 lb)

Articulated Trucks

D25D Travel Time — Loaded/Empty
 ● 26.5R25 Tires

LOADED

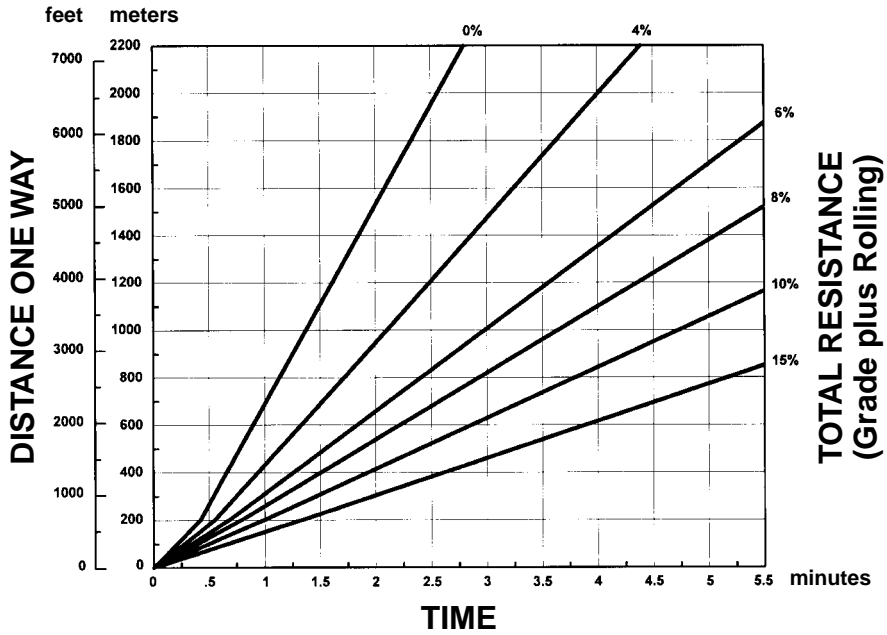

EMPTY

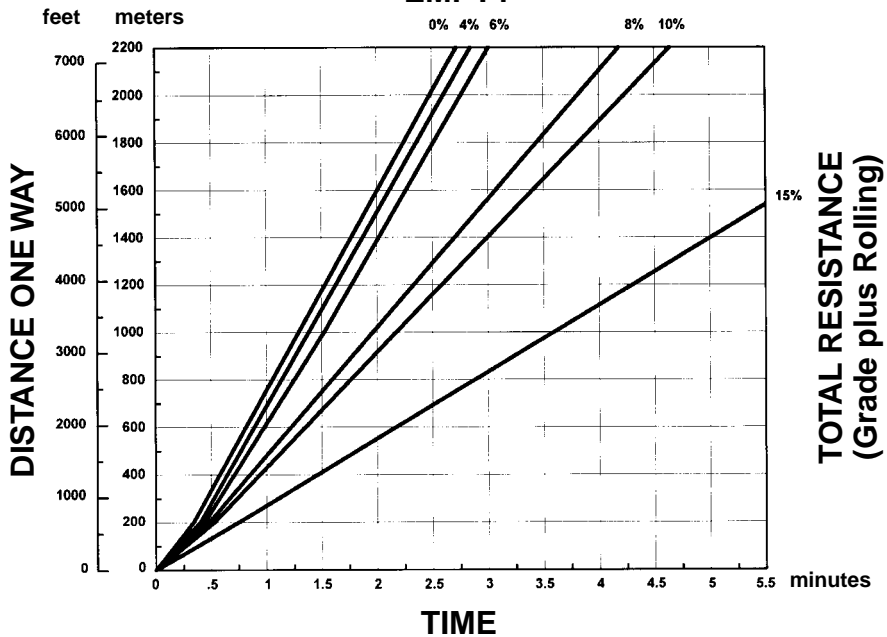

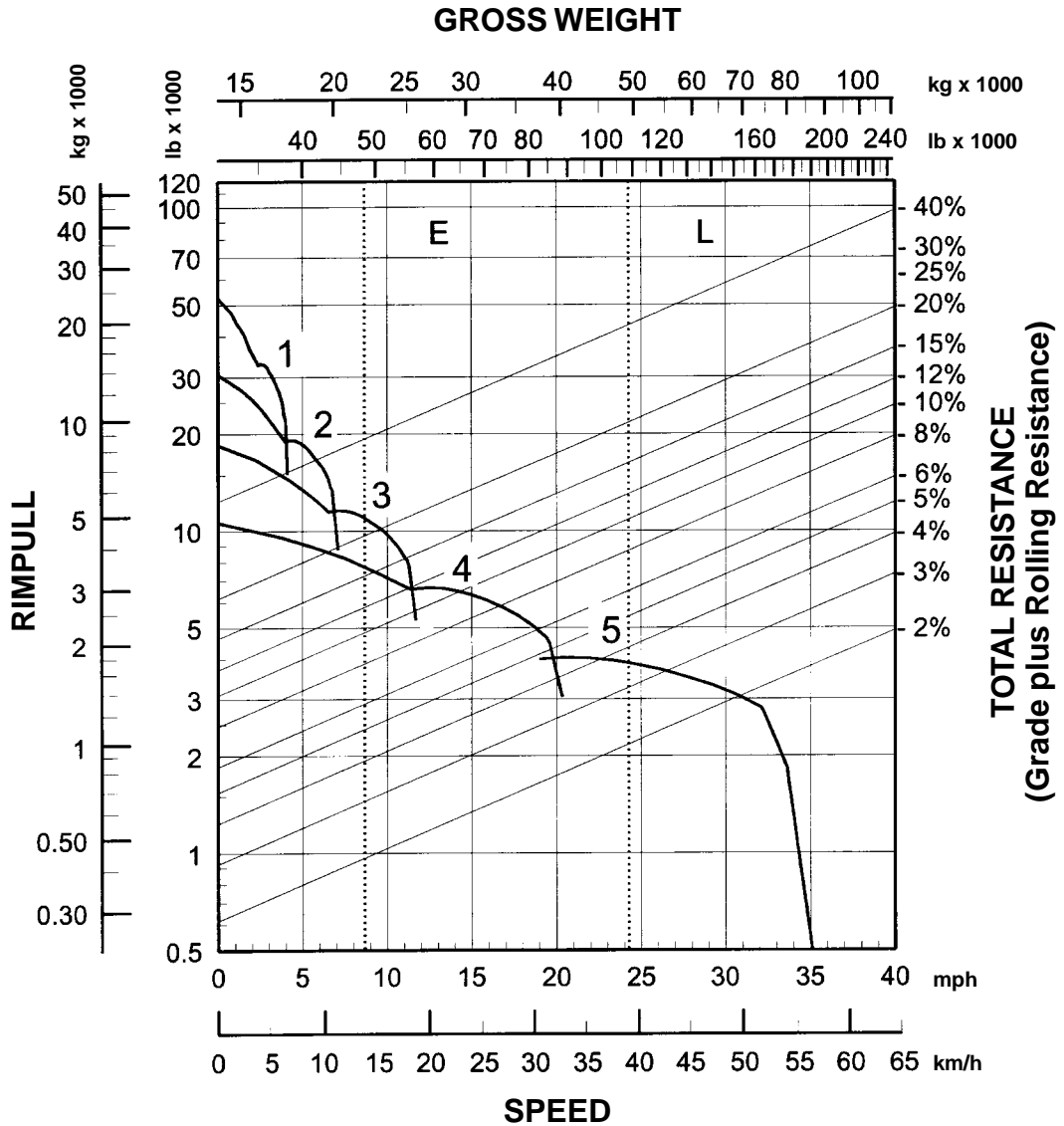

KEY

- 1 — 1st Gear
- 2 — 2nd Gear
- 3 — 3rd Gear
- 4 — 4th Gear
- 5 — 5th Gear

KEY

- E — Empty 21 900 kg (48,278 lb)
- L — Loaded 49 117 kg (108,278 lb)

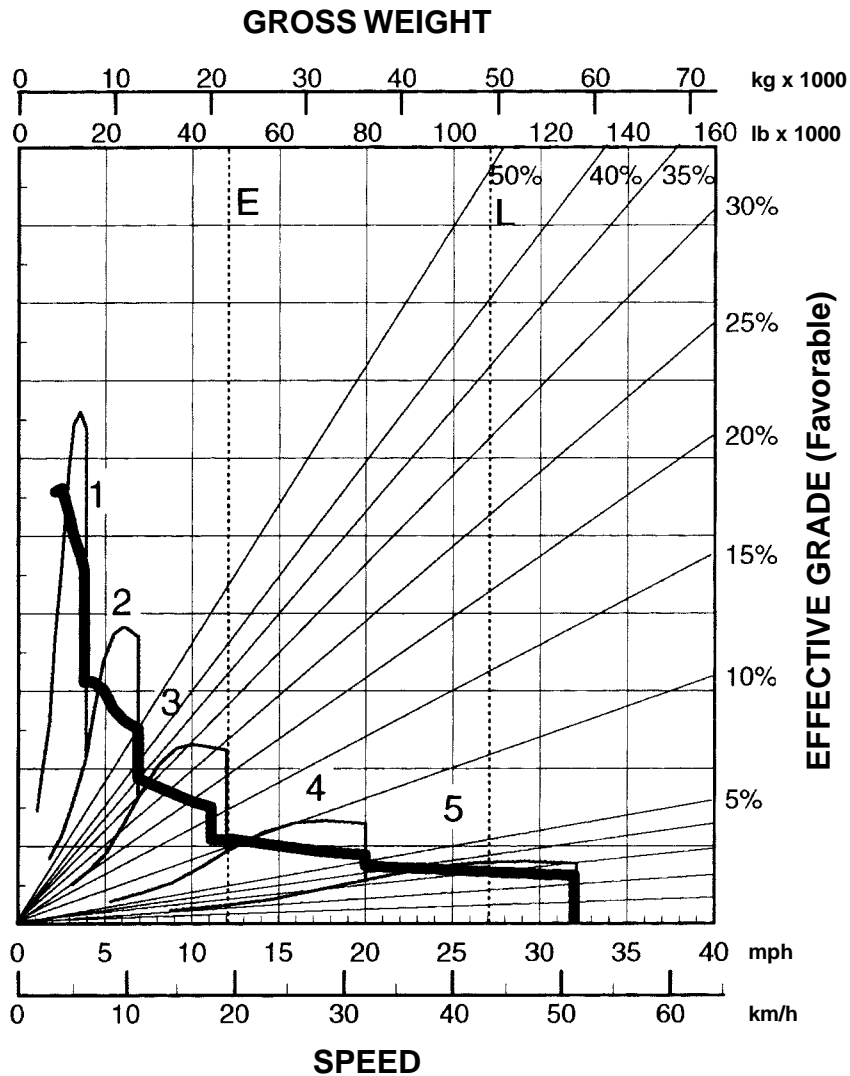

—— 200 m (660 ft) OR LESS GRADE LENGTH
— CONTINUOUS

KEY

- 1 — 1st Gear
- 2 — 2nd Gear
- 3 — 3rd Gear
- 4 — 4th Gear
- 5 — 5th Gear

KEY

- E — Empty 21 900 kg (48,278 lb)
- L — Loaded 49 117 kg (108,278 lb)

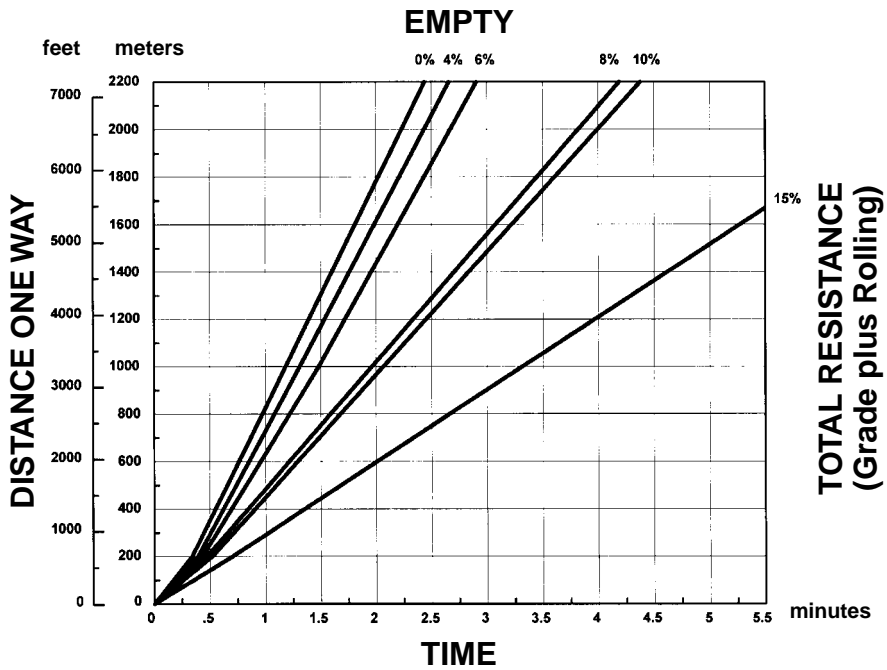
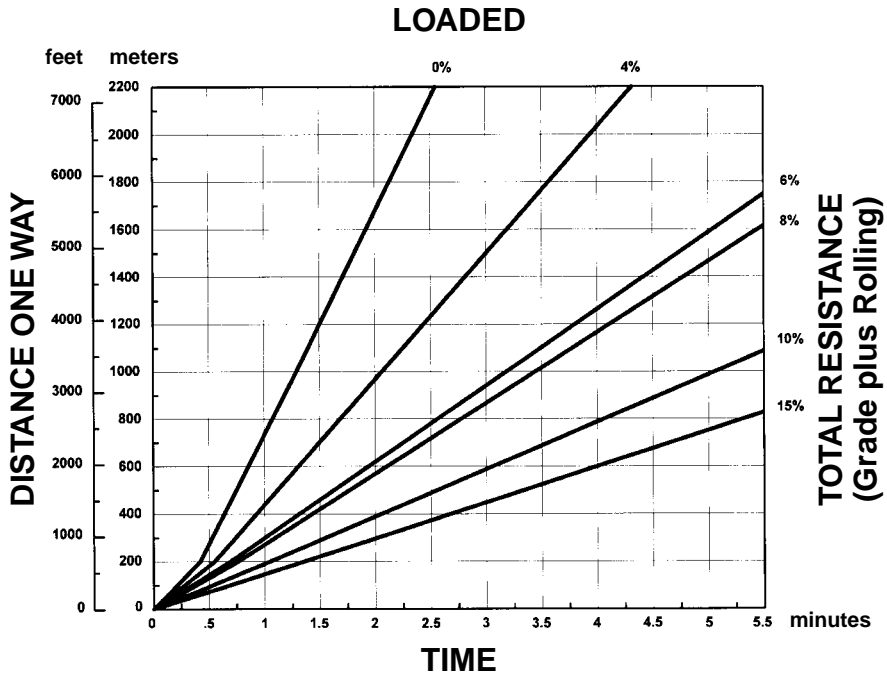

Preliminary Information
GROSS WEIGHT

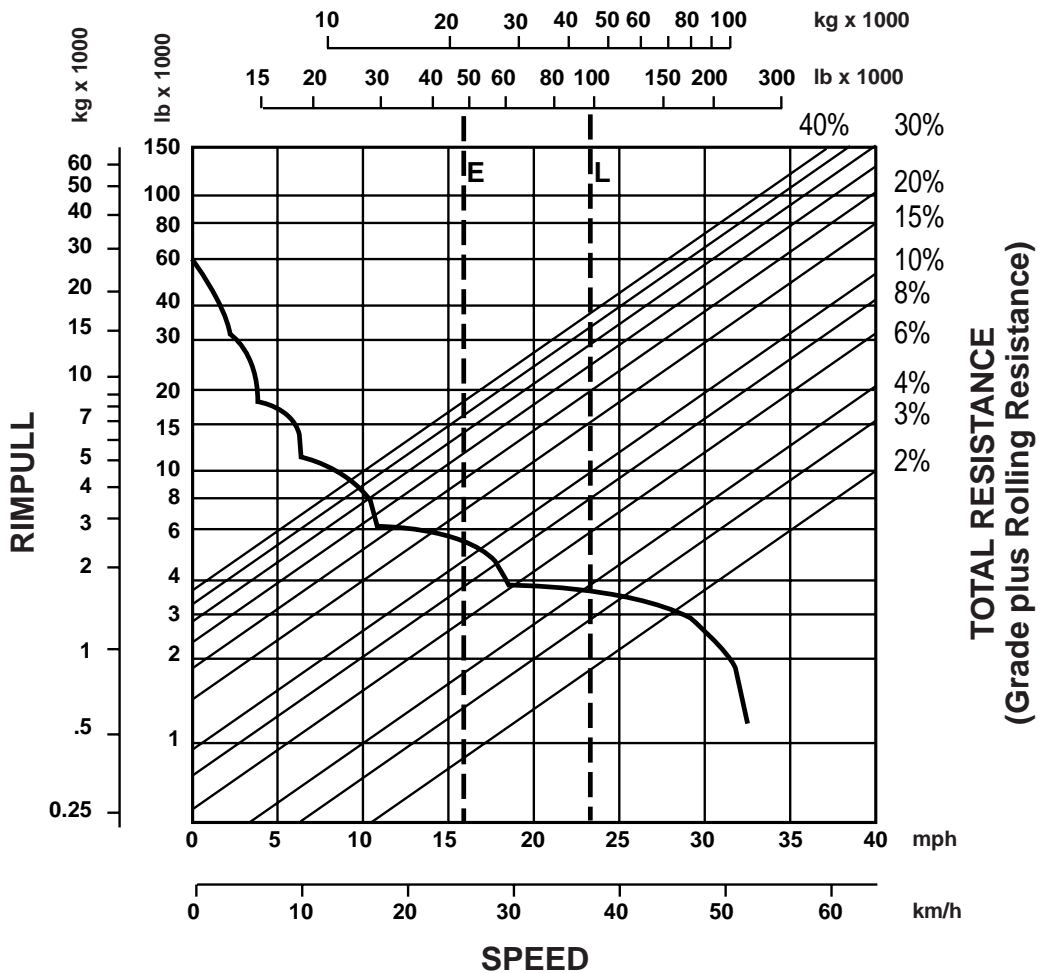

- KEY**
- 1 — 1st Gear
 - 2 — 2nd Gear
 - 3 — 3rd Gear
 - 4 — 4th Gear
 - 5 — 5th Gear

- KEY**
- E — Empty 21 700 kg (47,840 lb)
 - L — Loaded 44 380 kg (97,840 lb)

Preliminary Information
GROSS WEIGHT

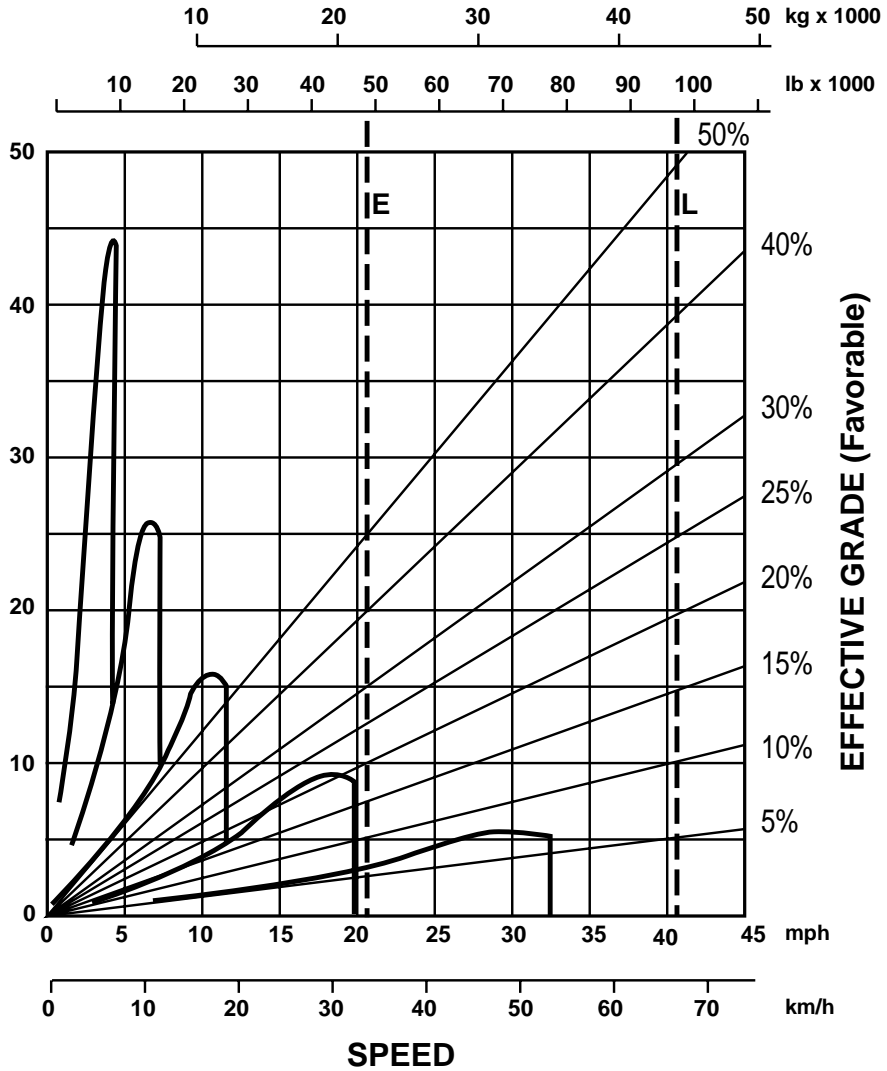

10

- KEY**
- 1 — 1st Gear
 - 2 — 2nd Gear
 - 3 — 3rd Gear
 - 4 — 4th Gear
 - 5 — 5th Gear

- KEY**
- E — Empty 21 700 kg (47,840 lb)
 - L — Loaded 44 380 kg (97,840 lb)

Preliminary Information
LOADED

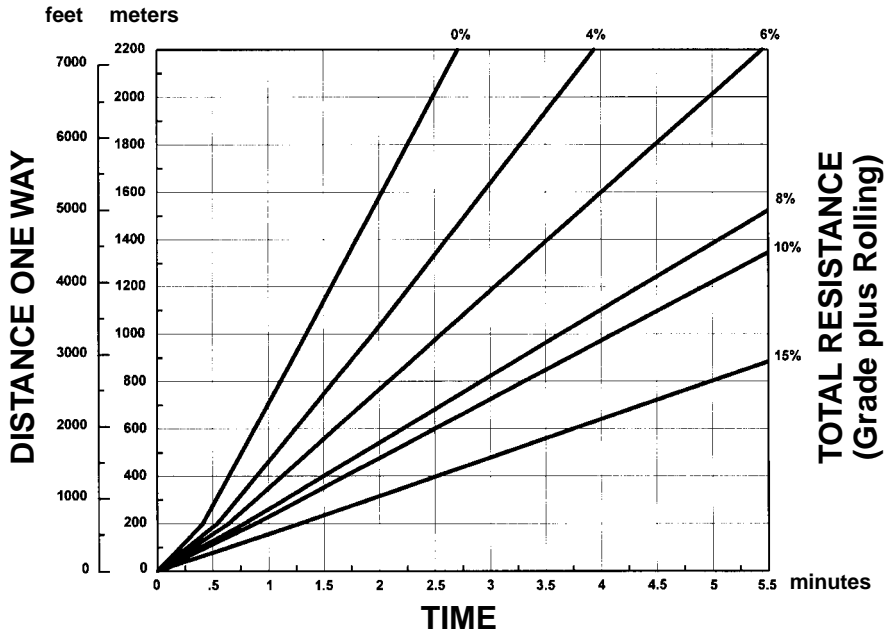

EMPTY

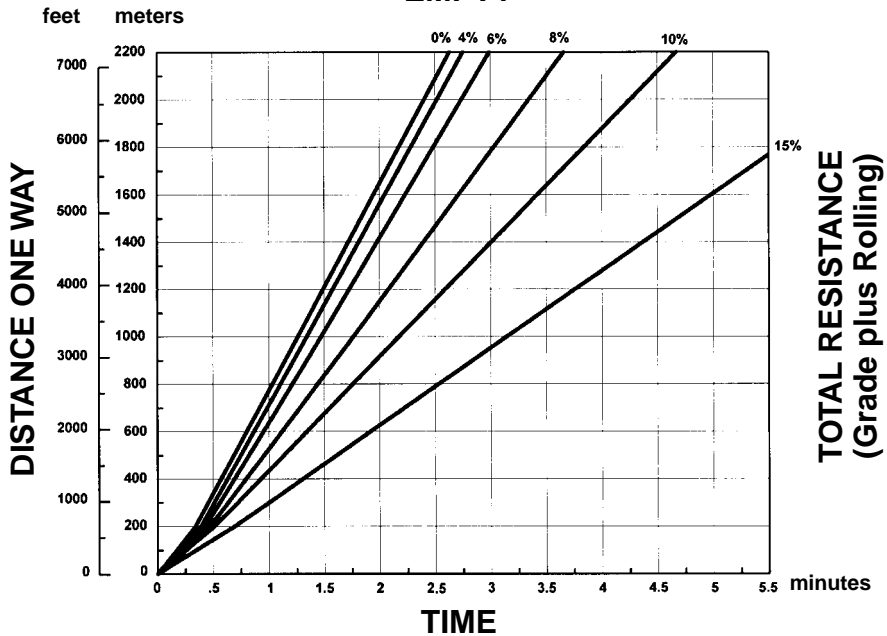

Preliminary Information
GROSS WEIGHT

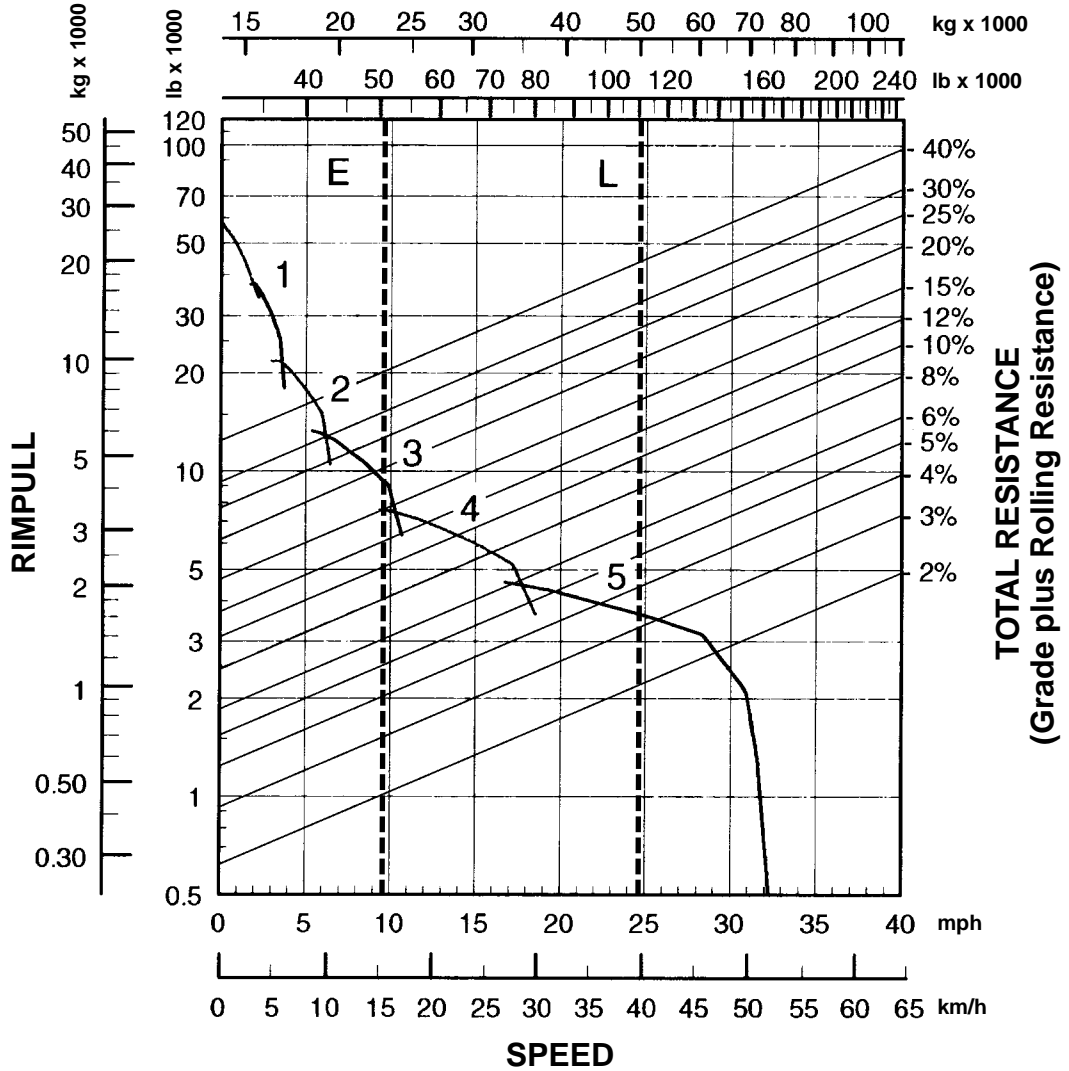

- KEY
- 1 — 1st Gear
 - 2 — 2nd Gear
 - 3 — 3rd Gear
 - 4 — 4th Gear
 - 5 — 5th Gear

- KEY
- E — Empty 22 890 kg (50,460 lb)
 - L — Loaded 50 100 kg (110,460 lb)

Preliminary Information
GROSS WEIGHT

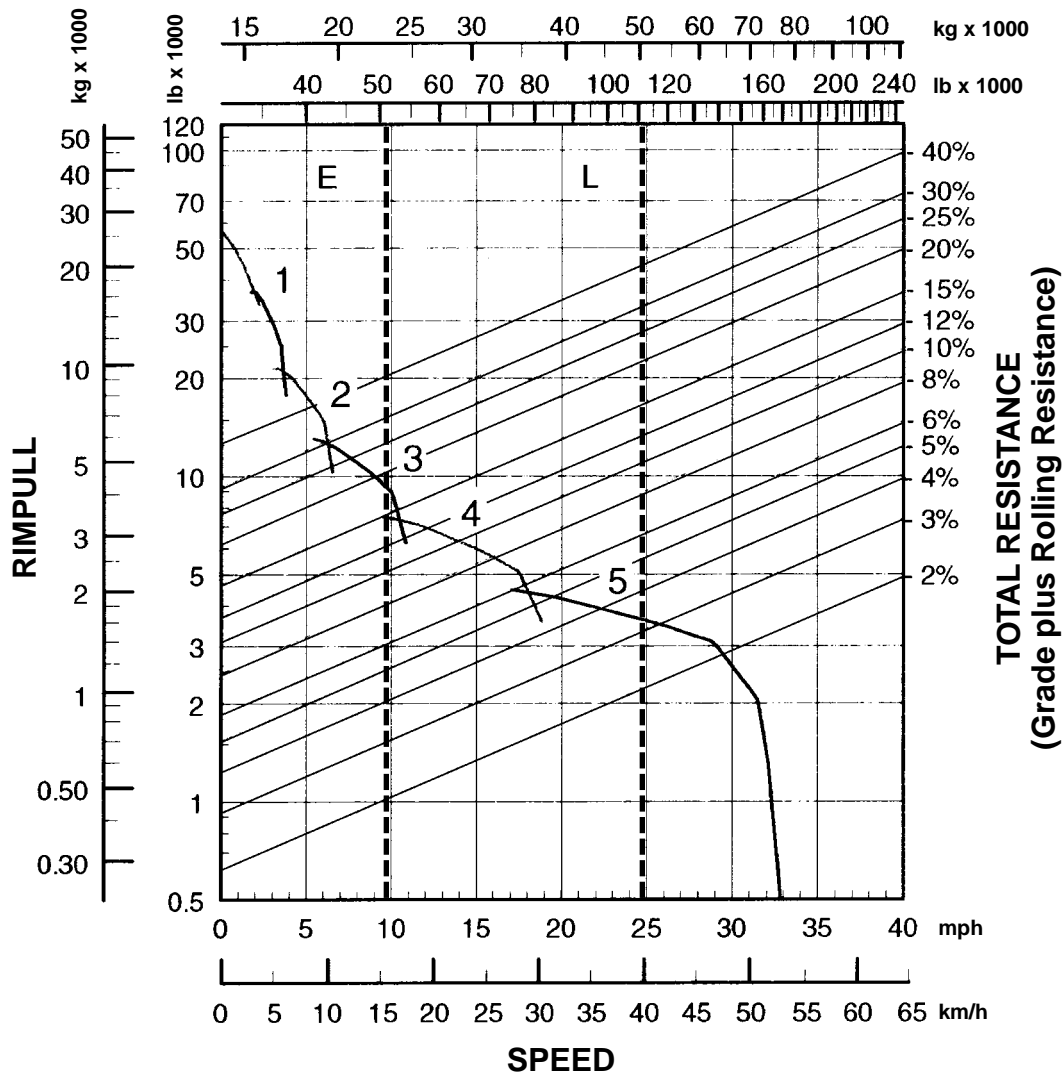

- KEY**
- 1 — 1st Gear
 - 2 — 2nd Gear
 - 3 — 3rd Gear
 - 4 — 4th Gear
 - 5 — 5th Gear

- KEY**
- E — Empty 22 890 kg (50,460 lb)
 - L — Loaded 50 100 kg (110,460 lb)

Preliminary Information
GROSS WEIGHT

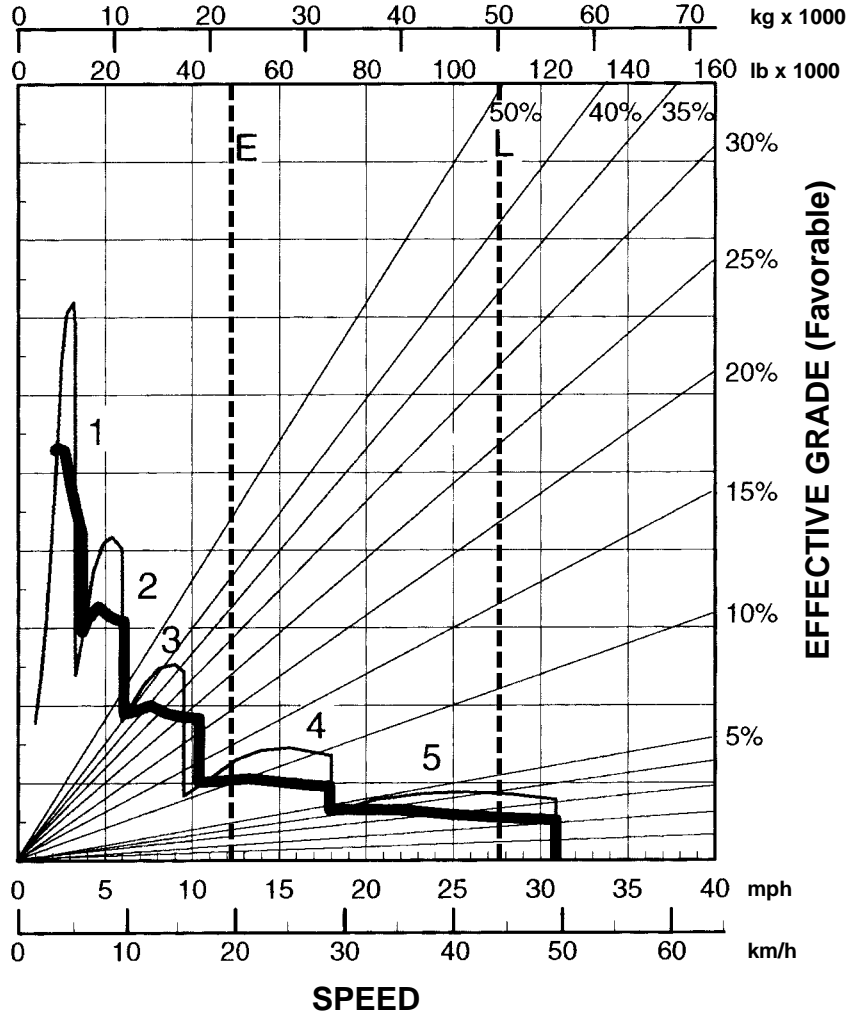

— 200 m (660 ft) OR LESS GRADE LENGTH
 — CONTINUOUS

- KEY**
- 1 — 1st Gear
 - 2 — 2nd Gear
 - 3 — 3rd Gear
 - 4 — 4th Gear
 - 5 — 5th Gear

- KEY**
- E — Empty 22 890 kg (50,460 lb)
 - L — Loaded 50 100 kg (110,460 lb)

Preliminary Information

GROSS WEIGHT

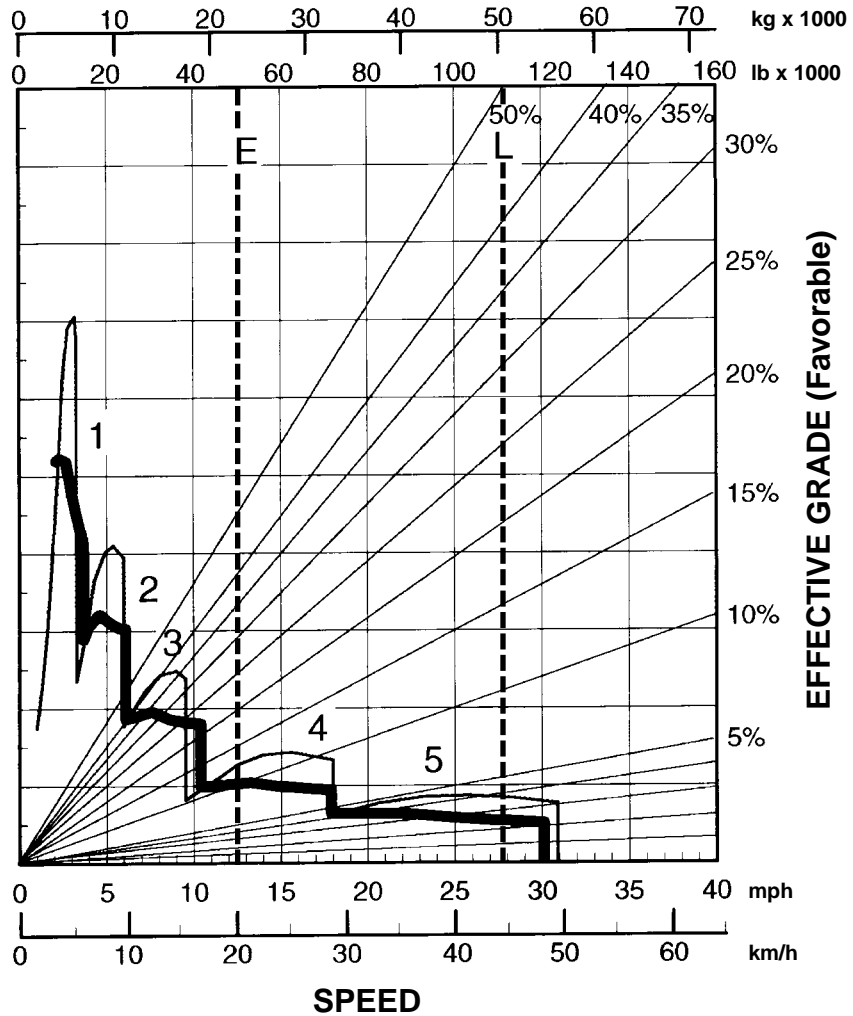

— 200 m (660 ft) OR LESS GRADE LENGTH
 — CONTINUOUS

KEY

- 1 — 1st Gear
- 2 — 2nd Gear
- 3 — 3rd Gear
- 4 — 4th Gear
- 5 — 5th Gear

KEY

- E — Empty 22 890 kg (50,460 lb)
- L — Loaded 50 100 kg (110,460 lb)

Preliminary Information
LOADED

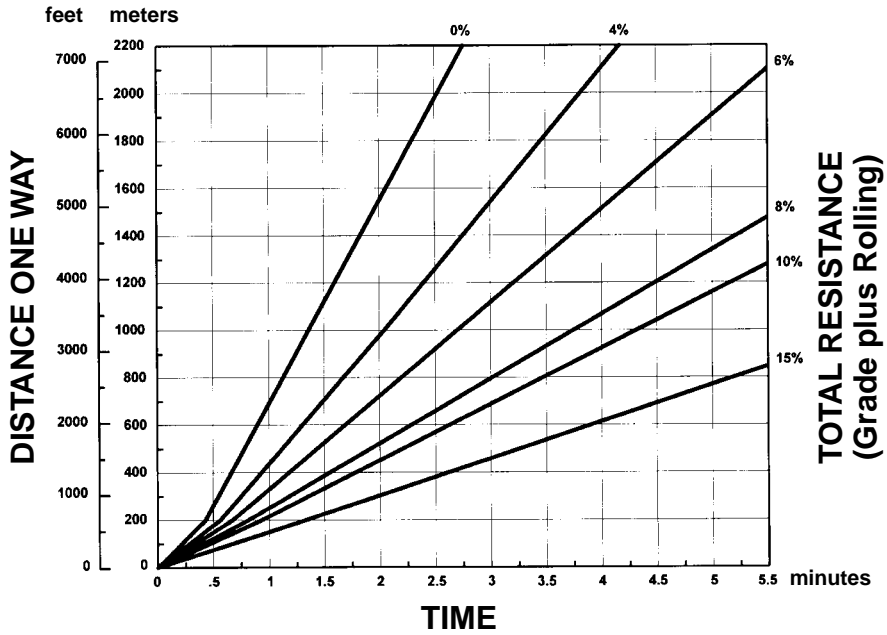

EMPTY

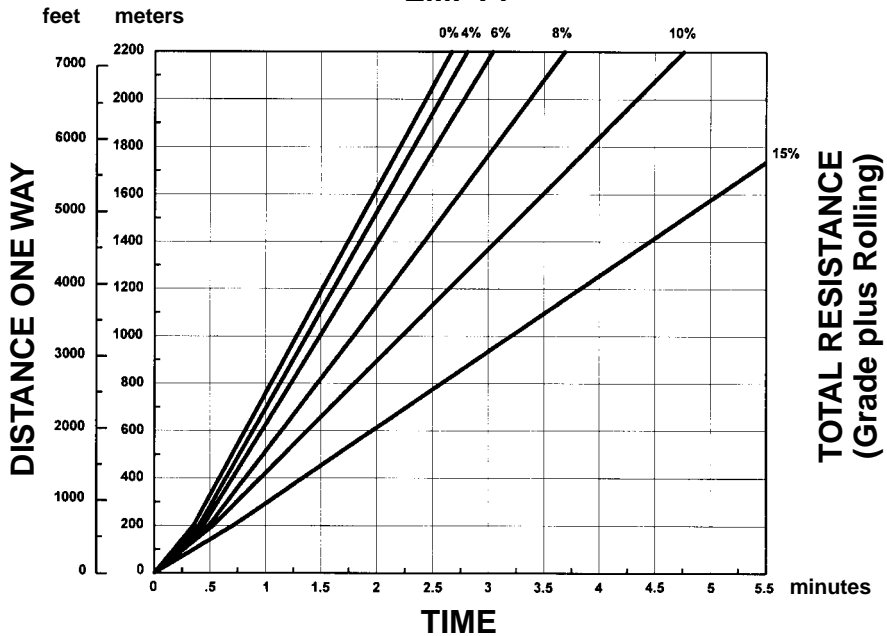

Preliminary Information
LOADED

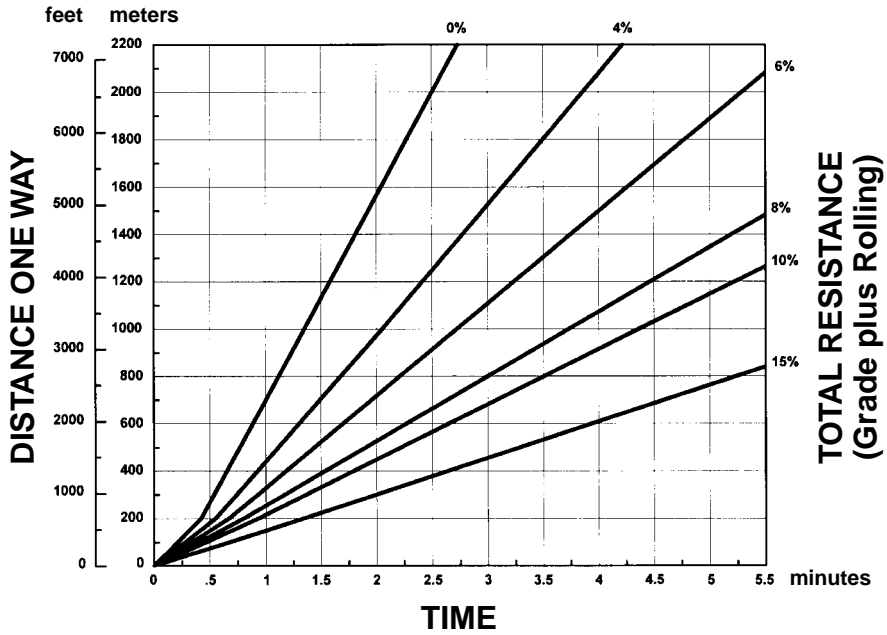

EMPTY

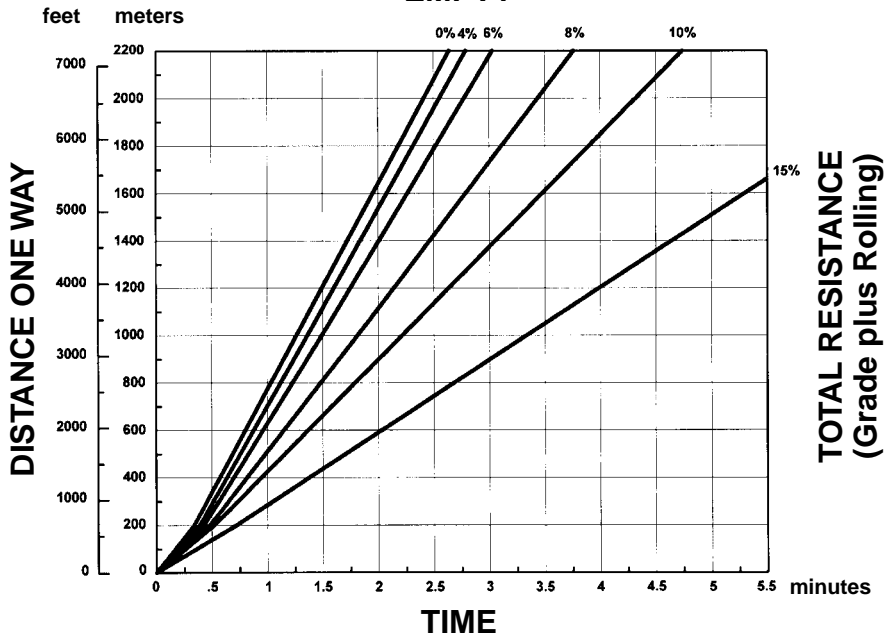

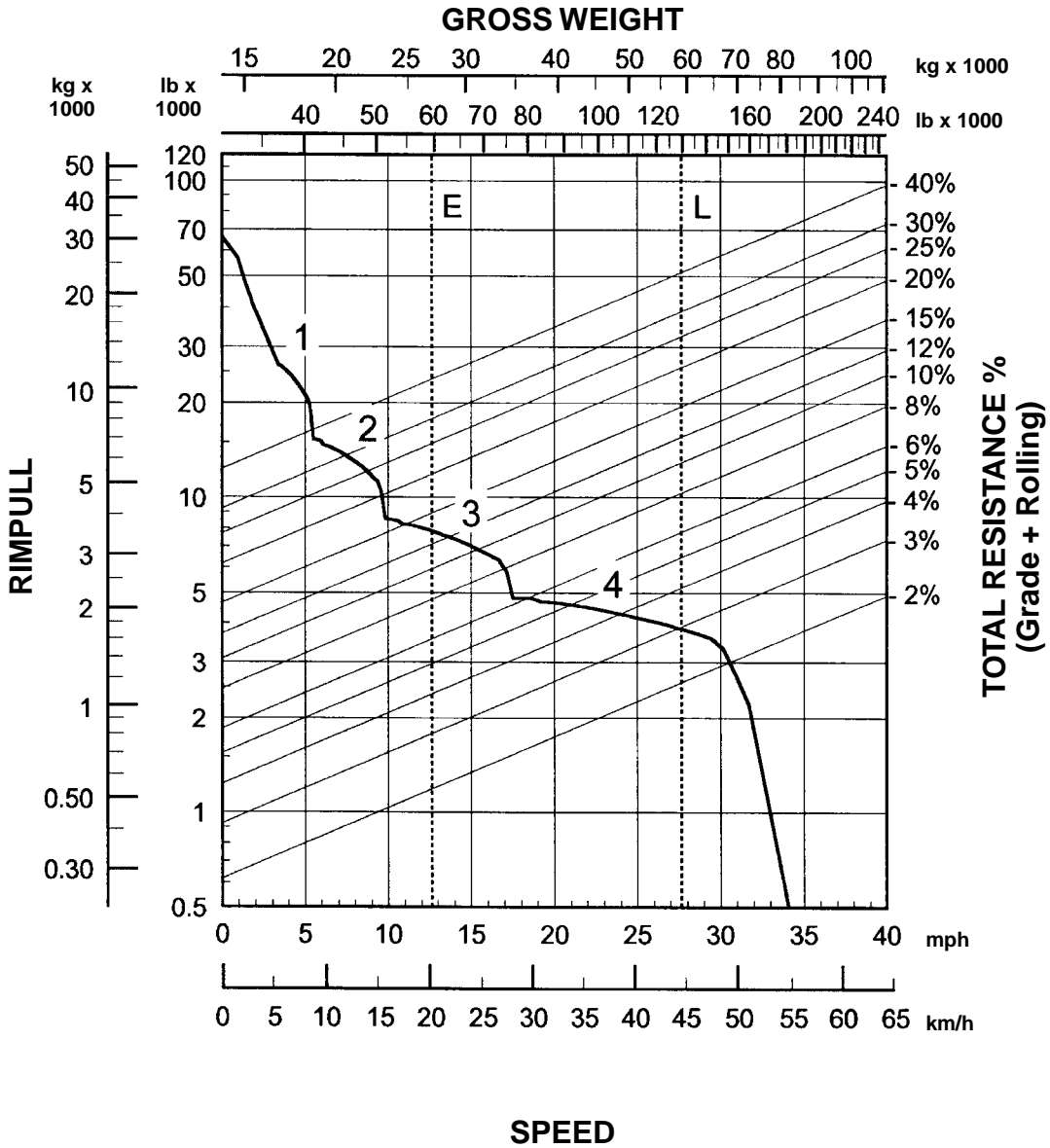

GROSS WEIGHT

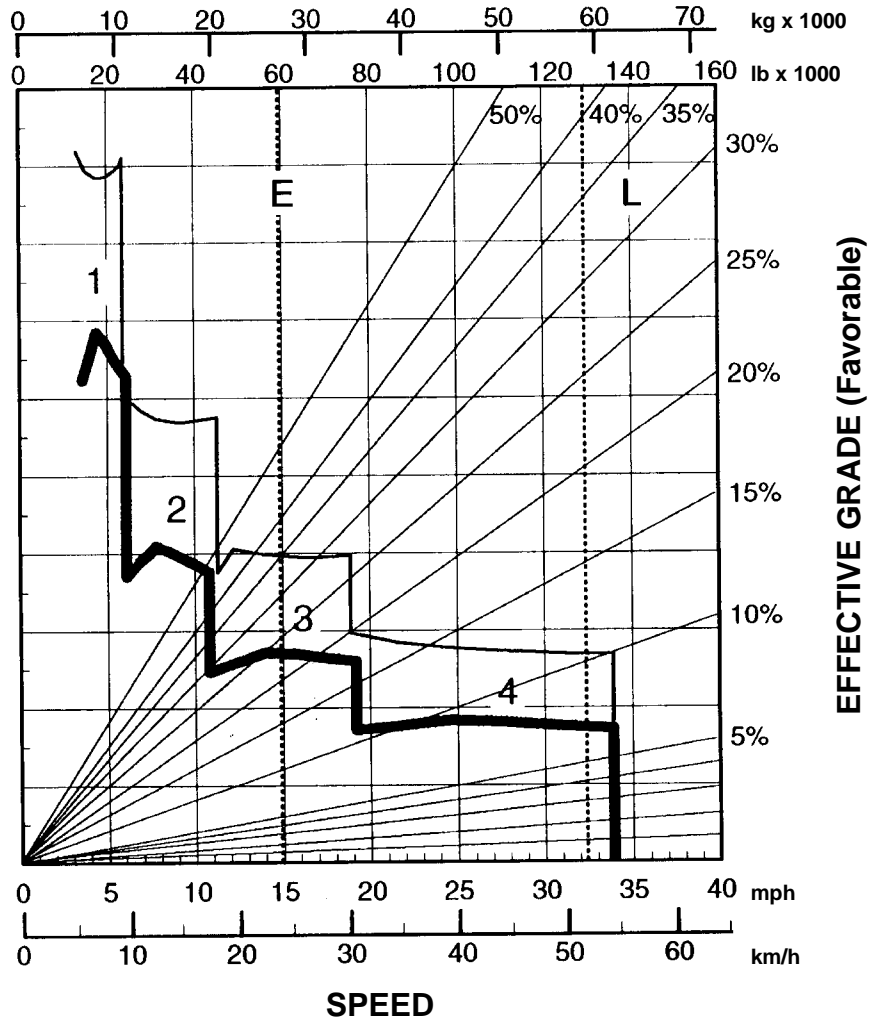

— 200 m (660 ft) OR LESS GRADE LENGTH
— CONTINUOUS

KEY
 1 — 1st Gear
 2 — 2nd Gear
 3 — 3rd Gear
 4 — 4th Gear

KEY
 E — Empty 26 990 kg (59,500 lb)
 L — Loaded 58 750 kg (129,520 lb)

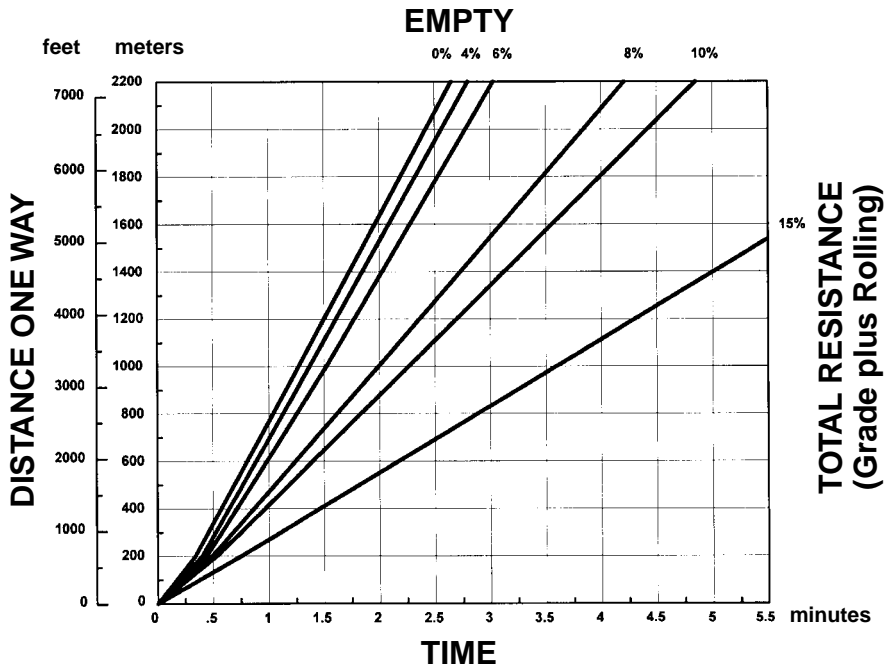
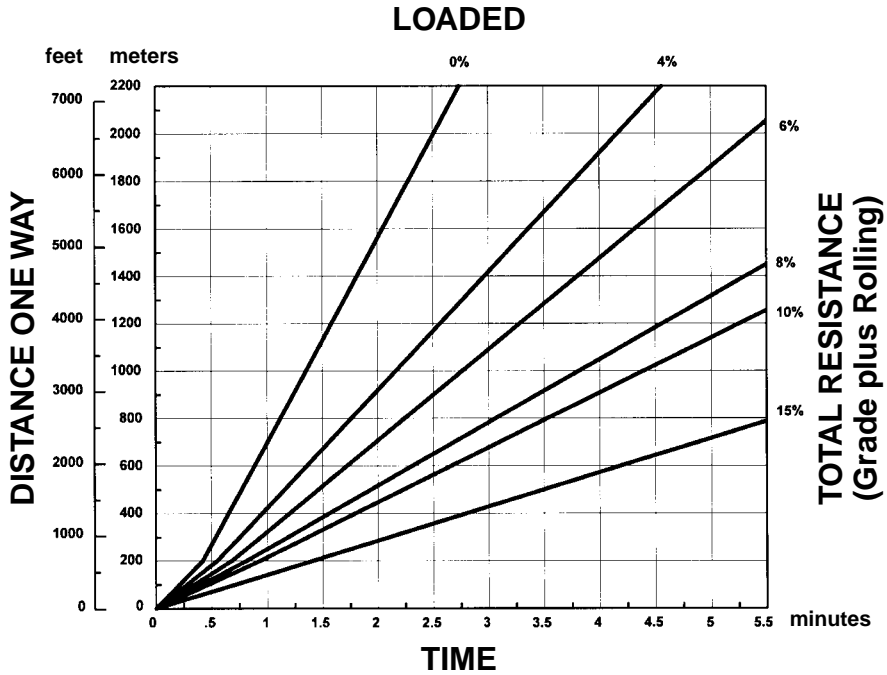

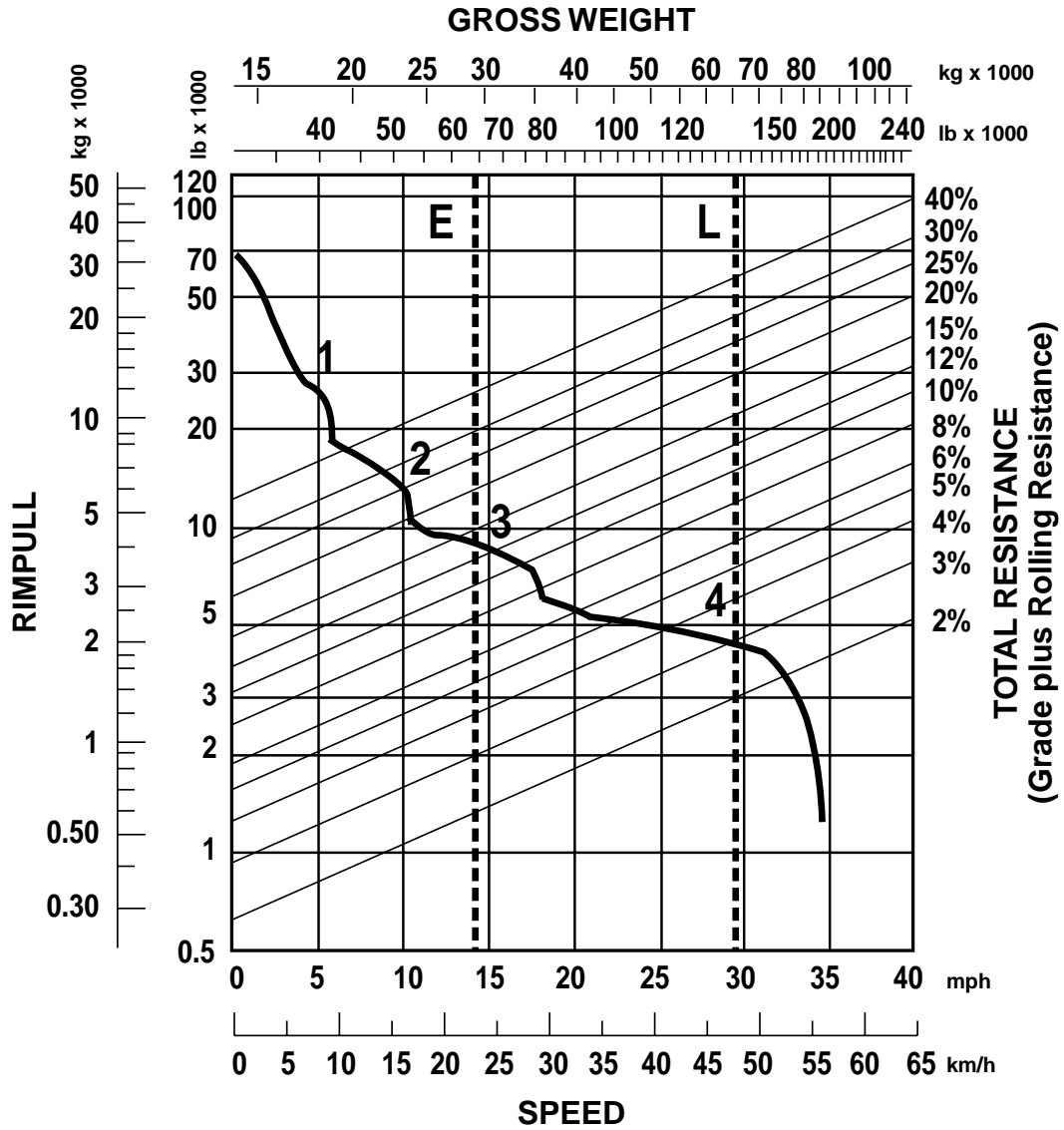

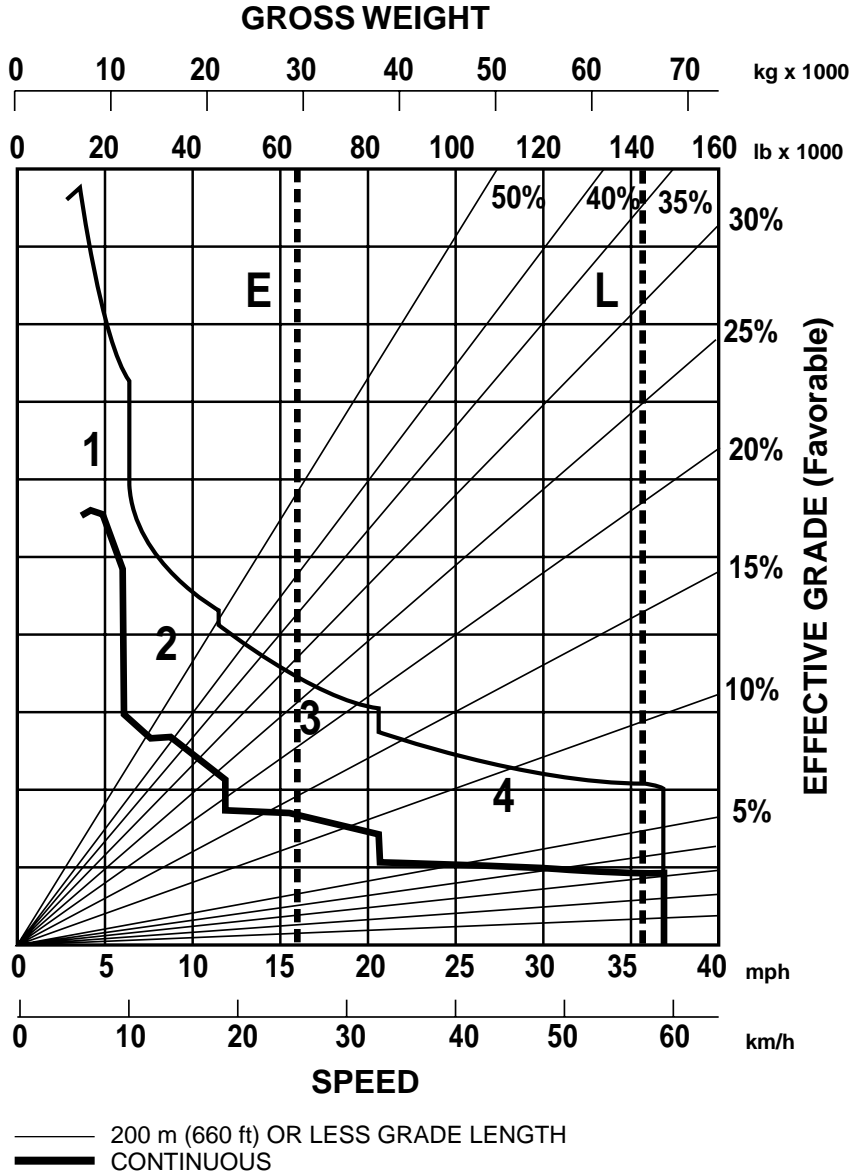

KEY

1 — 1st Gear
 2 — 2nd Gear
 3 — 3rd Gear
 4 — 4th Gear

KEY

E — Empty 29 260 kg (64,510 lb)
 L — Loaded 65 560 kg (144,500 lb)

LOADED

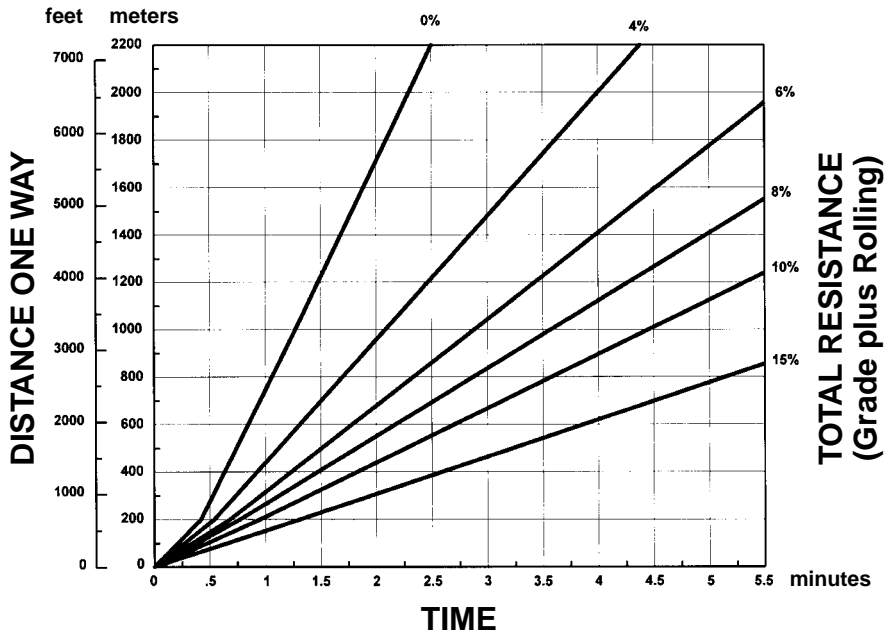

EMPTY

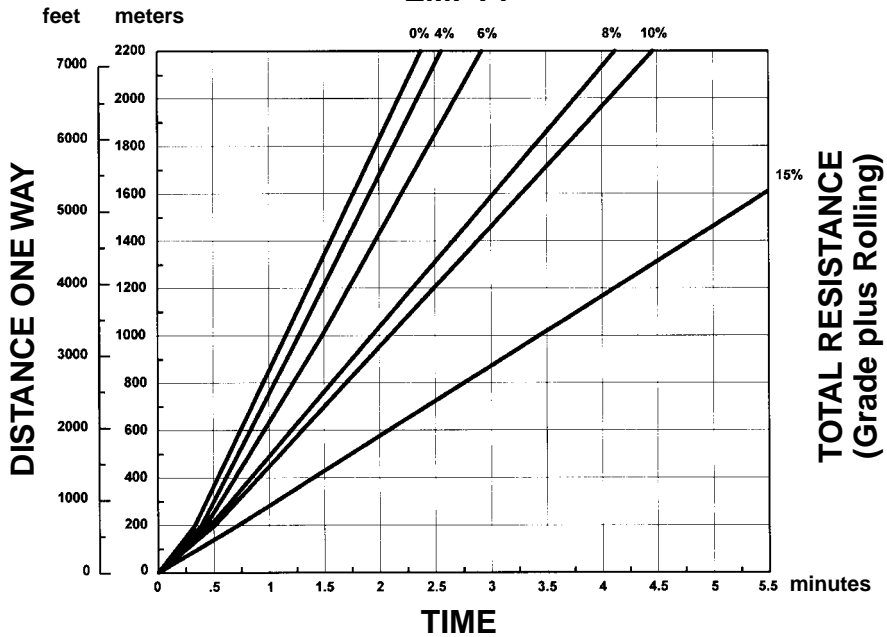

WHEEL TRACTORS SOIL COMPACTORS LANDFILL COMPACTORS

CONTENTS

WHEEL TRACTORS

Features	11-1
Specifications	11-2
Travel speeds	11-4
Rimpull	11-4
Machine selection	11-6
Counterweights and ballast	11-6
Tire selection and maintenance	11-6
Bulldozer specifications	11-8
Special attachments	11-9

SOIL COMPACTORS

Features	11-11
Specifications & Rimpull	11-12
Compaction fundamentals	11-13
Compactor types and zones of application	11-14
Estimating production (example problem)	11-15
Production table	11-16
Bulldozer specifications	11-16

LANDFILL COMPACTORS

Features	11-17
Specifications & Rimpull	11-18
Compaction fundamentals	11-19
Blade specifications	11-20

WHEEL TRACTORS

Features:

- **Reliable Cat power train:** four-stroke-cycle diesel with adjustment-free fuel system ... full power shift with single lever on-the-go shifting.
- **Articulated frame steering** with hinge point midway between front and rear axles ... short turning radius, long wheelbase ... rear and front wheels track at all times.
- **Machine balance** ... equal weight distribution on axles when blading.
- **All dozer functions**, including tip and tilt, hydraulically controlled from operator's seat.



MODEL	814F		824G		834B	
Flywheel Power	164 kW	220 hp	235 kW	315 hp	336 kW	450 hp
Operating Weight*	18 611 kg	40,944 lb	26 620 kg	58,564 lb	46 355 kg	102,213 lb
Engine Model	3306 DITA (EMISSIONS)		3406C DITA (EMISSIONS)		3408E HEUI	
Rated Engine RPM	2200		2100		2100	
No. Cylinders	6		6		8	
Displacement	10.5 L	638 in³	14.6 L	893 in³	18 L	1098 in³
Speeds:						
Forward	4		4		4	
Reverse	4		4		4	
Top Speed Forward	29.9 km/h	18.6 mph	33.0 km/h	20.4 mph	34.1 km/h	21.2 mph
Turning Circle with Blade	12.5 m	41'0"	14.6 m	40'0"	17.2 m	56'6"
Standard Tire Size	23.5-25, 12 PR (L-2)		29.5-25, 16 PR (L-3)		35/65-33, 24 PR (L-4)	
Fuel Tank Refill Capacity	462 L	122 U.S. gal	630 L	166.5 U.S. gal	595 L	157 U.S. gal
GENERAL DIMENSIONS:						
Height (to top of ROPS)	3.368 m	11'1"	3.764 m	12'4"	4.102 m	13'5.5"
Height (stripped top)**	2.418 m	7'11"	2.676 m	8'9"	2.955 m	9'8"
Wheel Base	3.350 m	11'0"	3.700 m	12'2"	3.810 m	12'6"
Overall Length with Dozer	6.844 m	22'5"	8.020 m	26'4"	8.716 m	28'7"
Width (over standard tires)	2.865 m	9'5"	3.28 m	10'9"	3.556 m	11'8"
Ground Clearance	448 mm	17.6"	383 mm	15.1"	466 mm	18"
STRAIGHT BULLDOZER:						
Width	3.650 m	12'0"	4.51 m	14'9"	4.623 m	15'2"
Height	1.004 m	3'4"	1.23 m	4'0"	1.448 m	4'9"
Capacity	2.91 LCM	3.8 LCY	4.67 LCM	6.11 LCY	7.27 LCM	9.5 LCY***
Ground Clearance Below Skid Shoe	940 mm	3'1"	955 mm	3'1.6"	1118 mm	3'8"
Depth of Cut	460 mm	18.1"	430 mm	16.9"	441 mm	17"
Tilt Adjustment	747 mm	2'5.4"	1.18 m	3'11"	1.278 m	4'2"
Tip Adjustment		18°		23°		22°
Lift Speed	0.40 m/sec	1.3 ft/sec	0.46 m/sec	1.5 ft/sec	0.40 m/sec	1.3 ft/sec

*Operating Weight includes straight dozer, 75% CaCl₂ in all tires, lubricants, coolant, ROPS cab, full fuel tank and operator. 75% CaCl₂ in all tires adds the following weight to each model: 814F — 1996 kg (**4400 lb**), 824G — 3881 kg (**8556 lb**), 834B — 5360 kg (**11,816 lb**).

**Height (stripped top) — without ROPS, exhaust, seat back or easily removed encumbrances.

***Capacity of 834B U-Blade is 10.48 LCM (**13.7 LCY**).



MODEL	844		854G	
Flywheel Power	466 kW	625 hp	597 kW	800 hp
Operating Weight*	73 830 kg	162,410 lb	96 470 kg	212,230 lb
Engine Model	3412E HEUI		3508B EUI	
Rated Engine RPM	2000		1750	
No. Cylinders	12		8	
Displacement	27 L	1649 in ³	34.5 L	2105 in ³
Speeds:				
Forward	3		3	
Reverse	3		3	
Top Speed Forward	22.5 km/h	14.0 mph	20.5 km/h	12.7 mph
Turning Circle with Blade				
Standard Tire Size	45/65R39, PR (L-4)		45/65R45, L-4	
Fuel Tank Refill Capacity	930 L	245 U.S. gal	1345 L	355 U.S. gal
GENERAL DIMENSIONS:				
Height (to top of ROPS)	5.142 m	16'9"	5.50 m	18'3"
Height (stripped top)**	3.469 m	11'4"	3.984 m	13'1"
Wheel Base	4.60 m	15'1"	5.89 m	19'3"
Overall Length with Dozer	10.94 m	35'9"	13.405 m	44'0"
Width (over standard tires)				
Ground Clearance	1197 mm	3'9"	1314 mm	4'3"
SEMI-U DOZER:				
Width	5.278 m	17'4"	6.604 m	20'8"
Height	1.877 m	6'2"	2.124 m	6'11"
Capacity	16.1 m ³	21.1 yd ³	25.4 m ³	33.1 yd ³
Ground Clearance Below				
Skid Shoe	1372 mm	4'5"	1539 mm	5'1"
Depth of Cut	466 mm	18"	398 mm	16"
Tilt Adjustment	830 mm	2'7"	1165 mm	3'8"
Tip Adjustment		13°		15°
Lift Speed	0.353 m/sec	1.2 ft/sec	0.385 m/sec	1.3 ft/sec

*Operating Weight includes straight dozer, 75% CaCl₂ in all tires, lubricants, coolant, ROPS cab, full fuel tank and operator.

**Height (stripped top) — without ROPS, exhaust, seat back or easily removed encumbrances.

MODEL	814F		824G		834B		844		854G	
FORWARD										
GEAR	km/h	mph	km/h	mph	km/h	mph	km/h	mph	km/h	mph
1	5.6	3.5	5.9	3.6	6.3	3.9	7.2	4.5	6.9	4.3
2	9.8	6.1	10.5	6.5	11.3	7.0	12.9	8.0	12.0	7.4
3	17.2	10.7	18.6	11.5	19.8	12.3	22.5	14.0	20.5	12.7
4	29.9	18.6	33.0	20.4	34.1	21.2	—	—	—	—
REVERSE										
GEAR										
1	6.3	3.9	6.8	4.2	7.9	4.9	8.2	5.0	7.7	4.8
2	11.3	7.0	12.0	7.4	14.0	8.7	14.2	8.8	13.3	8.3
3	19.6	12.2	21.3	13.2	24.5	15.2	25.0	15.5	22.7	14.1
4	34.1	21.1	37.8	23.5	41.8	25.9	—	—	—	—

814F

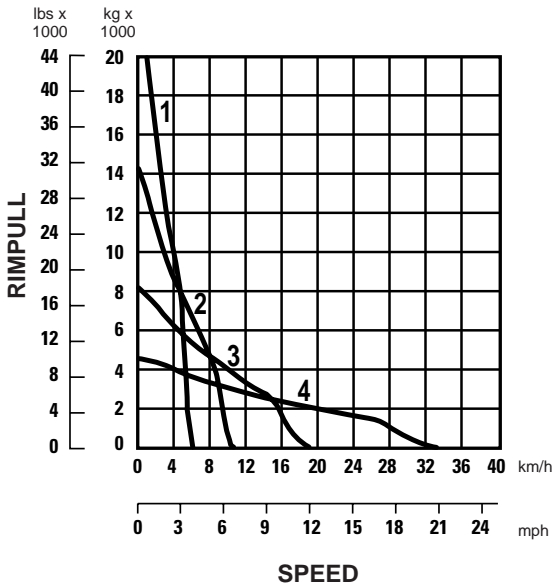

824G

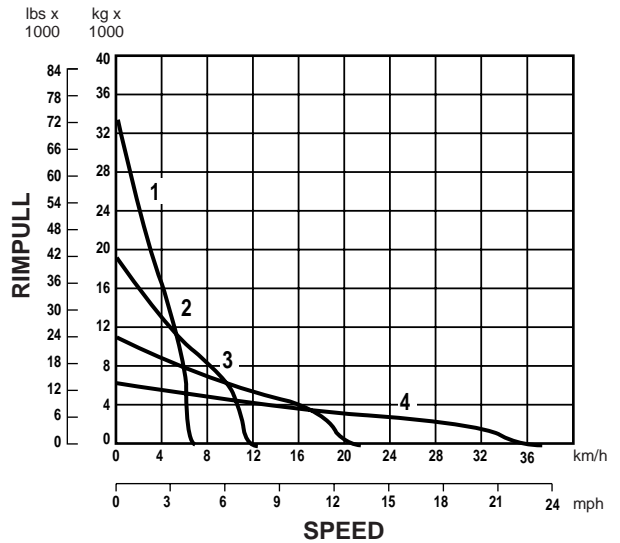

Usable rimpull depends upon traction and weight of tractor.

- KEY
- 1 - 1st Gear
 - 2 - 2nd Gear
 - 3 - 3rd Gear
 - 4 - 4th Gear

834B

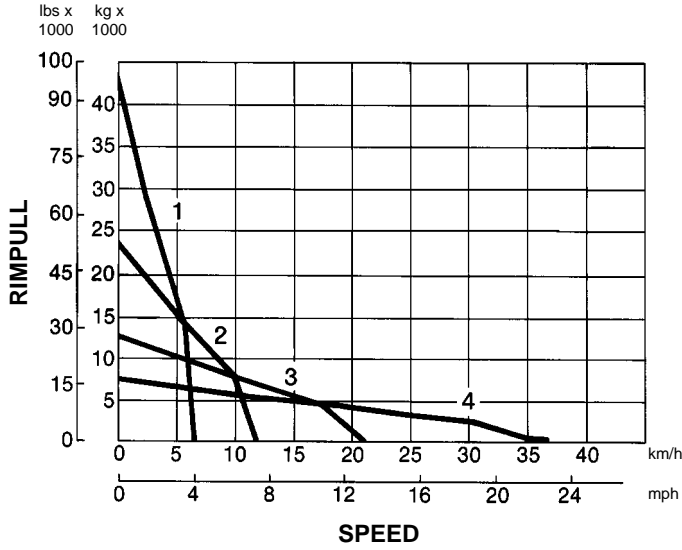

Usable rimpull depends upon traction and weight of tractor.

- KEY
- 1 - 1st Gear
 - 2 - 2nd Gear
 - 3 - 3rd Gear
 - 4 - 4th Gear
- Torque Converter
- _____
Direct Drive

844

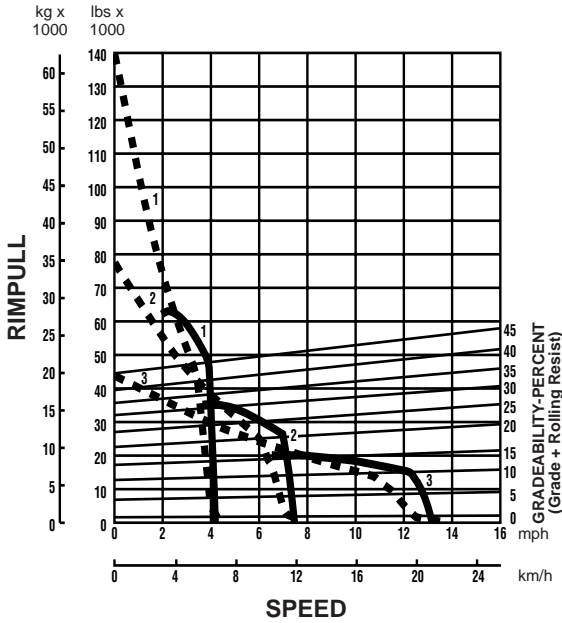

854G

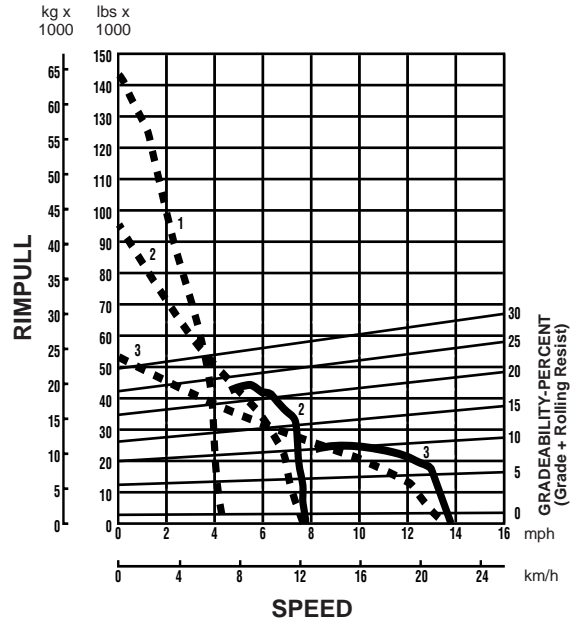

CONSIDERATIONS IN MACHINE SELECTION

The following factors should be considered when comparing wheels vs. tracks:

Traction

You can figure coefficient of traction, depending on underfoot conditions, from the Table Section in this book.

Wheels — up to 0.65 (in quarry pit with good floor)

Track — up to 0.90 (in soils permitting grouser penetration)

Usable Rimpull = Machine Weight × Coefficient of Traction

Speed

Wheels — travel speeds up to three times higher than track.

Maneuverability

Articulated steering and good visibility give wheel tractors high maneuverability.

Cost

See Owning and Operating Costs section. Tire vs undercarriage costs can often be the deciding factor in selecting wheels or tracks.

Compaction

Ground Pressure:

Wheels — from 241 kPa (35 psi) to 310 kPa (45 psi)

Tracks — from 82 kPa (12 psi) to 97 kPa (14 psi)

Application

Utility ... mobility, maneuverability and good speed suit wheel tractors for yard and stockpile work and for clean-up around shovels. Lower maintenance costs may be realized in certain soils that can be highly abrasive to track-type undercarriages.

Coal pile ... recommend wheel tractors in this application when following conditions are present:

- Long push distances
- Need for good material spread
- High degree of compaction desired

Production Dozing ... a wheel tractor should be considered in the following conditions:

- Long push distances
- Loose soils, little or no rock
- Level or downhill work
- Good underfoot conditions

Pushloading Scrapers ... a wheel tractor should be considered in the following conditions:

- Thin scraper cut
- Good underfoot conditions — no rock
- Higher push speeds

Chip and Coal Scoops ... may adversely affect performance and/or reliability, particularly when adverse grades are encountered.

COUNTERWEIGHTS AND BALLAST

For each specific application, there is a correct machine weight for proper balancing of traction, flotation, mobility and response.

- Low machine weight may increase tire slipping and wear, but improves flotation, mobility and machine response.
- High machine weight increases traction, but decreases mobility and response.

The machine weight is optimum for the operating conditions when wheel slipping barely occurs in the gear being used. Weight distribution under operating conditions should then be approximately equal between the wheels to balance power to each axle.

Application

Lower machine weight is usually required for typical second gear applications, such as fill spreading, stockpiling, road maintenance, towing compactors and shovel cleanup.

Higher machine weight is usually required for such typical first gear applications as heavy dozing and pushloading.

Tire Ballast

A solution of calcium chloride and water is recommended for tire ballast. It has the advantage of low cost with simple quick adjustment to suit working conditions.

TIRE SELECTION & MAINTENANCE

Requirements of traction, flotation and tire life are met by a choice of tire size, tread design and inflation pressure.

Tire Width

For good conditions with little rolling resistance on surfaces where flotation is no problem, a narrower tire may be most economical. It may also be considered in muddy conditions in which the mud can be penetrated to reach firm earth underneath.

Where flotation problems and increased rolling resistance are encountered, wider tires are recommended. The greater contact area and shallower penetration increases flotation.

Tire Size

Larger optional tires will also improve flotation in soft conditions. With larger diameter, rimpull will be reduced which may be desirable to help control wheel spin.

Traction Tread (L-2) tire's penetration ability provides improved traction under some soil conditions.

Rock Tread (L-3) offers improved traction and a more cut resistant rubber compound than the L-2. It provides more rubber at the ground with the same footprint and reduces tire penetration under abrasive conditions. Recommended on any hard smooth surface such as rock, concrete or compacted earth.

Rock — Deep Tread (L-4) provides 50% more tread depth, thicker undertread and sidewall with increased tire life when compared to the L-3 tire. Recommended in rock conditions where sharp fragments cause high tire wear or sudden failures.

Rock — Extra Deep Tread (L-5) provides 150% more tread depth when compared to the L-3 tire. Intended for severe rock conditions with extreme penetration hazards.

Chains should be considered in severe applications where extra tread tires still give unsatisfactory life. Operating costs vary greatly depending on application, underfoot conditions, wheel spin and chain maintenance. Under normal rock operating conditions (short cycle, low average speed and minimum wheel spin) the maximum estimated chain life is about 2000 hours. Before installing chains, carefully weigh their overall economics against known tire costs. Chains are not recommended with new rock extra tread tires but can extend the life of a used tire. Always check clearance around tires before using chains.

Major applications where chains can be considered include:

- stripping rock or rocky soils
- clean-up work around rock loading shovels
- any application where underfoot conditions cause excessive tire wear.

Inflation Pressure

In average operating conditions the recommended inflation pressure prevents excessive deflection and minimizes tire rollover on side slopes.

Over-inflation

Reduces amount of tread contact with ground and provides less flotation. Over-inflation causes center of tread to wear faster and increases the chance of cuts and impact breaks.

Under-inflation

Can cause permanent tire damage in the form of flex breaks, radial cracks, and tread or ply separation. On jobs where wrinkling and bead rollover *are not* apparent, inflation pressure may be reduced to a minimum of:

Bias Ply — 170 kPa (25 psi) on 35/65-33
 170 kPa (25 psi) on 29.5-25
 170 kPa (25 psi) on 26.5-25
 170 kPa (25 psi) on 23.5-25

Radial — 310 kPa (45 psi) on 35/65R 33
 310 kPa (45 psi) on 29.5R 25
 205 kPa (30 psi) on 26.5R 25
 240 kPa (35 psi) on 23.5R 25

Reduced pressure will:

- Increase flotation and traction in sand.
- Improve envelopment characteristics to reduce sudden death failure on rock jobs.
- Provide better tread wear by reducing contact pressure between tire and ground.

MODEL	814F		824G		834B	
Type	Straight		Straight		Straight	
Capacity**	2.89 m ³	3.77 yd ³	5.12 m ³	6.70 yd ³	7.26 m ³	9.5 yd ³
Weight, Dozer*	3740 kg	8245 lb	5136 kg	11,323 lb	4738 kg	10,443 lb
General Dimensions (Tractor & Dozer)						
Length	6.82 m	22'5"	8.29 m	27'2"	8.72 m	28'7"
Width	3.65 m	12'0"	4.51 m	14'9"	4.62 m	15'2"
Blade:						
Width (including std. end bits)	3.65 m	12'0"	4.51 m	14'9"	4.62 m	15'2"
Height	1004 mm	3'3.5"	1220 mm	4'0"	1462 mm	4'9"
Max. Digging Depth	460 mm	18.1"	430 mm	16.9"	441 mm	17.4"
Ground Clearance @ Full Lift Under Skid Plate	940 mm	3'1"	955 mm	3'1.6"	1118 mm	3'8"
Tilt Adjust. from Horizontal	747 mm	2'5.4"	1184 mm	3'10.6"	1278 mm	4'2"
Total Tip Adjustment	18°		22.4°		22°	

MODEL	834B		844		854G	
Type	U-Blade		Semi-U		Semi-U	
Capacity**	10.5 m ³	13.7 yd ³	15.9 m ³	20.7 yd ³	25.4 m ³	33.1 yd ³
Weight, Dozer*	4803 kg	10,588 lb	15 670 kg	34,520 lb	21 910 kg	48,270 lb
General Dimensions (Tractor & Dozer)						
Length	9.40 m	30'10"	10.94 m	35'9"	13.405 m	44'0"
Width	4.85 m	15'11"	5.42 m	17'8"	6.321 m	20'7"
Blade:						
Width (including std. end bits)	4.85 m	15'11"	5.42 m	17'8"	6.321 m	20'7"
Height	1448 mm	4'9"	1813 mm	5'9"	2179 mm	7'1"
Max. Digging Depth	442 mm	17.4"	466 mm	18.3"	398 mm	15.7"
Ground Clearance @ Full Lift Under Skid Plate	1118 mm	3'8"	1372 mm	4'6"	1539 mm	5'0.6"
Tilt Adjust. from Horizontal	1340 mm	4'5"	830 mm	2'8.7"	1165 mm	3'9.9"
Total Tip Adjustment	22°		13°		15°	

*Total Bulldozer Arrangement.

**Blade capacities determined by SAE J1265.

**BALDERSON
COAL U-BLADE**

	814F		824G		834B	
Balderson Models	BD814U-14		BD824U-15'9"		BD834U-20	
Replaces "S" Blade						
Blade:						
Capacity	10.55 m ³	13.8 yd³	16.1 m ³	21.0 yd³	21.18 m ³	27.7 yd³
Length (Cutting Width)	4318 mm	14'2"	4788 mm	15'8.5"	6198 mm	20'4"
Height, wing section (tapered down)	1473 mm	4'10"	1783 mm	5'10"	1803 mm	5'11"
Wing Angle	25°		30°		30°	
Weight, Installed (Without Hydraulics)	1810 kg	3985 lb	3085 kg	6800 lb	3560 kg	7850 lb

**BALDERSON
WOODCHIP U-BLADE**

	814F		824G		834B	
Balderson Models	BD814US-14		BD824US-15'9"		BD834US-20	
Replaces "S" Blade						
Blade:						
Capacity	16.7 m ³	21.9 yd³	23.9 m ³	31.4 yd³	29.8 m ³	39.0 yd³
Length (Cutting Width)	4318 mm	14'2"	4775 mm	15'8"	6096 mm	20'0"
Height, wing section	1880 mm	6'2"	2253 mm	7'4.7"	2235 mm	7'4"
Wing Angle	30°		30°		30°	
Weight	1975 kg	4350 lb	3630 kg	8000 lb	4295 kg	9470 lb

**BALDERSON
COAL SCOOP WITH TILT**

	814F		824G		834B	
Balderson Models	B14-15		B24-17		B34-26	
Replaces "S" Blade						
Scoop:						
Lift and Carrying Capacity	11.5 m ³	15.0 yd³	12.9 m ³	17.0 yd³	19.9 m ³	26.0 yd³
Dozing Capacity	19.1 m ³	25.0 yd³	25.8 m ³	34.0 yd³	37.5 m ³	49.0 yd³
Width	3734 mm	12'3"	4013 mm	13'2"	5283 mm	17'4"
Height	1626 mm	5'4"	—	—	2083 mm	6'10"
Depth	2083 mm	6'10"	—	—	2540 mm	8'4"
Overall length	7.3 m	24'0"	—	—	11.0 m	36'0"
Weight	5216 kg	11,500 lb	8400 kg	18,500 lb	8700 kg	19,180 lb
Dump Clearance	1041 mm	3'5"	—	—	1448 mm	4'9"

**BALDERSON
CHIP SCOOP WITH TILT**

	814F		824G		834B	
Balderson Models	B14-20S		B24-27S		B34-40S	
Replaces "S" Blade						
Scoop:						
Capacity/Lift & Carry	15.3 m ³	20.0 yd³	20.6 m ³	27.0 yd³	30.2 m ³	39.5 yd³
Capacity/Dozing	30.6 m ³	40.0 yd³	41.3 m ³	54.0 yd³	49.7 m ³	65.0 yd³
Width	3734 mm	12'3"	4026 mm	13'2.5"	4826 mm	15'10"
Height	2286 mm	7'6"	2794 mm	9'2"	2248 mm	7'4.5"
Depth	2464 mm	8'1"	2946 mm	9'8"	3023 mm	9'11"
Weight	5390 kg	11,880 lb	11 420 kg	19,125 lb	11 105 kg	24,480 lb

SOIL COMPACTORS

CONTENTS

Features	11-11
Specifications & Rimpull	11-12
Compaction fundamentals	11-13
Compactor types and zones of application	11-14
Estimating production (example problem)	11-15
Production table	11-16
Bulldozer specifications	11-16

Features:

- **Dozing, filling and compacting versatility.**
- **High speed operation** with responsive Caterpillar diesel Engine, single-lever planetary power shift transmission, and all-wheel drive.
- **Articulated frame** makes maneuvering quick and easy. Long wheel base for stability.
- **Wheels with tamping foot design and chevron pattern** give traction, penetration and compaction needed for high production. Foot pattern reversed on trailing drums to prevent overprinting lead drums.
- **Rear drums track front** for double compactive effort. Drum spacing covers mid-axle strip on return pass.
- **Rear axle oscillation** keeps all drums on ground for traction and stability.
- **Cleaner bars** keep drums free of carry over earth regardless of rolling direction. Adjustable, replaceable.
- **Optional fill spreading dozer** has single lever control for raise, lower, hold and float. (Blade tilt optional.)

● Rimpull



MODEL	815F		825G	
Flywheel Power	164 kW	220 hp	235 kW	315 hp
Operating Weight*	20 879 kg	45,934 lb	31 740 kg	69,828 lb
Engine Model	3306 DITA		3406C DITA	
Rated Engine RPM	2200		2100	
No. Cylinders	6		6	
Displacement	10.5 L	638 in ³	14.6 L	893 in ³
Speeds:				
Forward	4		3	
Reverse	4		3	
Turning Circle with Blade	12.6 m	41'5"	14.6 m	48'0"
Fuel Tank Refill Capacity	464 L	122.6 U.S. gal	630 L	166.5 U.S. gal
TAMPING FOOT WHEELS:				
Each Drum Width	978 mm	3'2.5"	1125 mm	3'8.3"
Diameters, over feet	1.42 m	4'7.9"	1.68 m	5'6"
over drum	1.03 m	3'4.5"	1.29 m	4'3"
Feet per Wheel	60		65	
Feet per Row	12		13	
Rows of Feet	5		5	
Foot Length	198 mm	7.8"	203 mm	8"
End Area Per Foot	116 cm ²	18 in ²	183 cm ²	28.4 in ²
Width of Two Pass Coverage	4.35 m	14'3"	4.88 m	16'0"
GENERAL DIMENSIONS:				
Height (top of ROPS)	3.34 m	11'0"	3.74 m	12'3"
Height (stripped top)**	2.39 m	7'10"	2.65 m	8'8"
Wheel Base	3.35 m	11'0"	3.70 m	12'2"
Overall Length with Dozer	6.82 m	22'5"	8.24 m	27'1"
Width over Drums	3.24 m	10'8"	3.65 m	12'0"
Ground Clearance	423 mm	17"	355 mm	14"
STRAIGHT BULLDOZER:				
Width	3.76 m	12'4"	4.41 m	14'5"
Height	860 mm	2'10"	1.03 m	3'5"

*Operating Weight includes coolant, lubricants, bulldozer, hydraulics, ROPS canopy, full fuel tank and operator.

**Height (stripped top) — without ROPS, exhaust, seat back or other easily removed encumbrances.

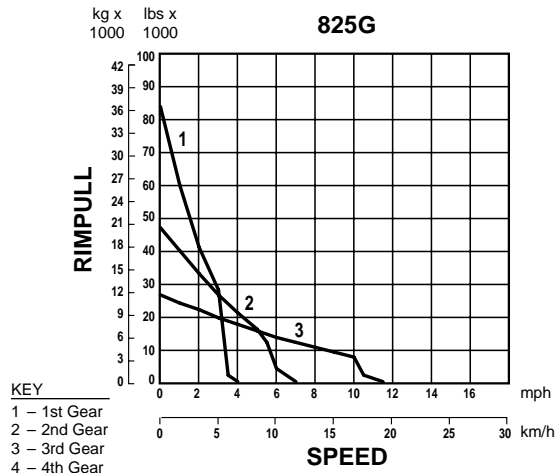
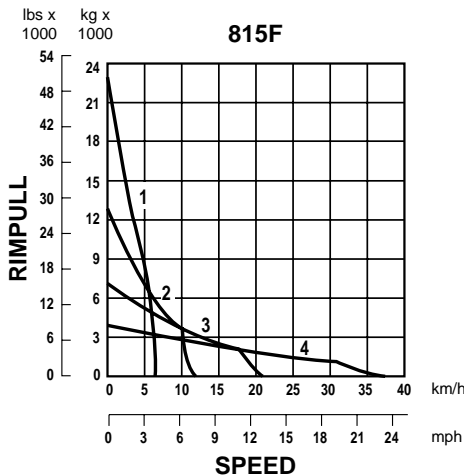

COMPACTION FUNDAMENTALS

The following discussion applies to soil compaction only. For information on refuse compaction, see Waste Disposal section of this book.

Definition

Compaction is the process of physically densifying or packing the soil ... resulting in increased weight per unit volume. It is generally accepted that the strength of a soil can be increased by densification. Three important factors affect compaction.

- Material gradation
- Moisture content
- Compactive effort

Material Gradation — refers to the distribution (% by weight) of the different particle sizes within a given soil sample. A sample is *well-graded* if it contains a good, even distribution of particle sizes. A sample composed of predominantly one size particle, is said to be *poorly-graded*. In terms of compaction, a well-graded soil will compact more easily than one that is poorly-graded. In well-graded material the smaller particles tend to fill the empty spaces between the larger particles, leaving fewer voids after compaction.

MATERIAL GRADATION

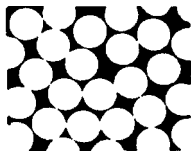

Poorly-graded

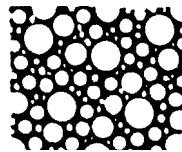

Well-graded

Moisture Content — or the amount of water present in a soil, is very important to compaction. Water lubricates soil particles thus helping them slide into the most dense position. Water also creates clay particle bonding, giving cohesive materials their sticky qualities.

OPTIMUM MOISTURE

Heavy clay	17.5%
Silty clay	15.0%
Sandy clay	13.0%
Sand	10.0%
Gravel, sand, clay mix (pit run)	7.0%

Experience has shown that it is very difficult, if not impossible, to achieve proper compaction in materials that are too dry or too wet. Soil experts have determined that in practically every soil there is an amount of water, called optimum moisture content, at which it is possible to obtain maximum density with a given amount of compactive effort. The curve below shows this relationship between dry density and moisture content. It is called a compaction curve, moisture-density curve or Proctor curve.

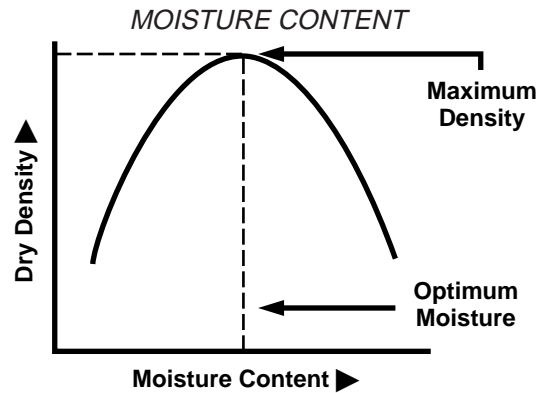

Compactive Effort — refers to the method employed by a compactor to impart energy into the soil to achieve compaction. Compactors are designed to use one or a combination of the following types of compactive effort.

- Static weight (or pressure)
- Kneading action (or manipulation)
- Impact (or sharp blow)
- Vibration (or shaking)

COMPACTOR TYPES

Compaction equipment can be grouped generally into the following classifications:

- sheepsfoot
- vibratory
- pneumatic
- high speed tamping foot
- chopper wheels (see Landfill Compactor section)

Combinations of these types are also available, such as a vibrating smooth steel drum.

For ease of comparison, the compactors have been placed on the Zones of Application Chart shown below. This chart contains a range of material moistures from 100% clay to 100% sand, plus a rock zone. Each type has been positioned in what is considered to be its most effective and economical zone of application. However, it is not uncommon to find them working out of their zones. Exact positioning of the zones can vary with differing material conditions.

RANGES OF SOIL TYPES FOR SOIL COMPACTION EQUIPMENT

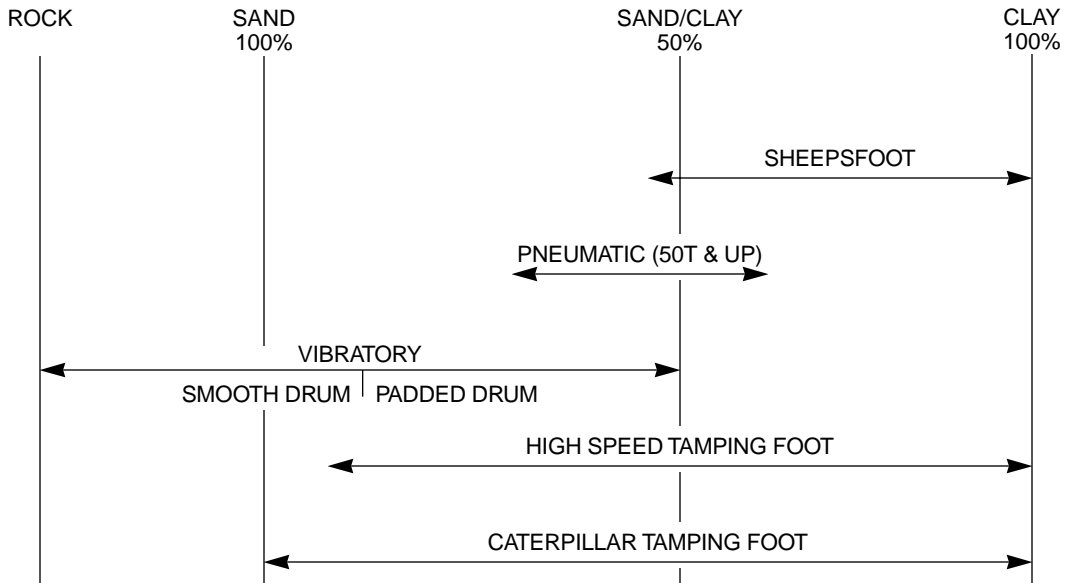

COMPACTOR PRODUCTION

Compactor production is expressed in compacted cubic meters (Cm³) or compacted cubic yards (CCY) per hour. Material in its natural or bank state is measured in bank cubic meters or yards (Bm³ or BCY). When it is removed or placed in a fill, it is measured in loose cubic meters or yards (Lm³ or LCY).

When the loose material is worked into a compacted state, the relationship of *compacted material to bank material* is shown as the shrinkage factor (SF).

$$SF = \frac{\text{Compacted cubic meters (Cm}^3\text{)}}{\text{Bank cubic meters (Bm}^3\text{)}}$$

$$SF = \frac{\text{Compacted cubic yards (CCY)}}{\text{Bank cubic yards (BCY)}}$$

The construction industry has developed the following formula for use in estimating compactor production. This formula gives the material volume a given machine can compact in a 60-minute hour.

Metric Method

$$Cm^3 = \frac{W \times S \times L}{P}$$

W = Compacted width per pass, in meters. (For Caterpillar Compactors it is recommended that W = Twice the width of one wheel.)

S = Average speed, in kilometers per hour.

L = Compacted thickness of lift, in millimeters.

P = Number of machine passes to achieve compaction (**can only be determined by testing the compacted material density on-the-job**).

English Method

$$CCY/Hr = \frac{W \times S \times L \times 16.3}{P}$$

W = Compacted width per pass, in feet. (For Caterpillar Compactors it is recommended that W = Twice the width of one wheel.)

S = Average speed, in miles per hour.

L = Compacted thickness of lift, in inches.

16.3 = Conversion constant, equals 5280 feet ÷ 12 inches ÷ 27 cubic feet

P = Number of machine passes to achieve compaction (**can only be determined by testing the compacted material density on-the-job**).

Example problem (Metric)

Determine production for an 815F operating under the following conditions:

$$P = 5, S = 10 \text{ km/h, } L = 100 \text{ mm}$$

Refer to 815F in the production table on the next page. Read down the first column until reaching section for 5 passes. Within this section in the second column, find the speed closest to 10 km/h. Read across this line to the 100 mm compacted lift. Read the production figure given.

Answer: 377 Cm³/h. (Since the machine's speed of 10 km/h is slightly faster than the 9.5 of the table, production may be interpolated slightly higher — say 395 Cm³/h.)

Example problem (English)

Determine production for an 825G operating under the following conditions:

$$P = 4, S = 8 \text{ mph, } L = 6 \text{ inches}$$

Refer to the production estimating table on the next page. This table contains estimates for the 815F and 825G Compactors using various speeds, lift thicknesses and number of passes. These figures were calculated using the formula discussed on this page. The figures represent 100% efficiency. W = Twice the width of one wheel.

In the 825 portion of this table, read down the first column until reaching the section for four passes. Within this section in the second column, find the line for 8 mph. Read across this line to the lift thickness column for 6 inches. Read the production figure given.

Answer: 1444 CCY/hr.



PRODUCTION TABLE

MODEL AND MACHINE PASSES*	AVERAGE SPEED		COMPACTED LIFT THICKNESS								
	km/h	mph	100 mm m ³ /h	4 in yd ³ /hr	150 mm m ³ /h	6 in yd ³ /hr	200 mm m ³ /h	8 in yd ³ /hr	250 mm m ³ /h	10 in yd ³ /hr	
815F 3	6.5	4	419	548	628	822	837	1095	—	—	
	9.5	6	628	822	942	1232	1256	1643	—	—	
	13.0	8	837	1095	1256	1643	1675	2191	—	—	
	4	6.5	4	314	411	471	616	628	822	—	—
		9.5	6	471	616	706	924	942	1232	—	—
		13.0	8	628	822	942	1232	1256	1643	—	—
	5	6.5	4	251	329	377	493	502	657	—	—
		9.5	6	377	493	565	739	754	986	—	—
		13.0	8	502	657	754	986	1005	1314	—	—
	6	6.5	4	286	274	314	411	419	548	—	—
		9.5	6	314	411	471	616	628	822	—	—
		13.0	8	419	548	628	822	837	1095	—	—
825G 3	6.5	4	488	642	731	962	975	1283	1219	1604	
	9.5	6	713	962	1069	1444	1425	1925	1781	2406	
	13.0	8	975	1283	1463	1925	1950	2566	2438	3208	
	4	6.5	4	366	481	534	722	731	962	914	1203
		9.5	6	534	722	802	1083	1069	1444	1336	1804
		13.0	8	731	962	1097	1444	1463	1925	1828	2406
	5	6.5	4	293	385	439	577	585	770	731	962
		9.5	6	428	577	641	866	855	1155	1069	1444
		13.0	8	585	770	878	1155	1170	1540	1463	1925
	6	6.5	4	244	321	366	481	488	642	609	802
		9.5	6	356	481	534	722	713	962	891	1203
		13.0	8	488	642	731	962	975	1283	1219	1604

*The number of machine passes required is dependent on soil type, moisture content, desired compaction and machine weight.

MODEL	815F		825G	
Type	Fill Spreading		Fill Spreading	
Capacity**				
Earth	2.16 m ³	2.82 yd ³	3.79 m ³	4.95 yd ³
Refuse	—	—	—	—
Weight, Dozer*	1460 kg	3220 lb	2831 kg	6241 lb
General Dimensions: (Tractor & Dozer)				
Length	6.82 m	22'5"	8.37 m	27'6"
Width	3.76 m	12'4"	4.61 m	15'2"
Blade Dimensions:				
Width, End Bits	3.76 m	12'4"	4.41 m	14'5"
Height, Moldboard	860 mm	2'10"	1.03 m	3'4"
Height, Trash Rack	—	—	—	—
Max. Digging Depth	407 mm	16"	312 mm	12.3"
Ground Clearance				
@ Full Lift	628 mm	2'0.7"	932 mm	3'0.7"
Tilt Adjust. from Horizontal	328 mm	12.9"	801 mm	2'7.5"

*Total Bulldozer Arrangement.

**Blade capacities determined by SAE recommended practice J1265.

LANDFILL COMPACTORS

CONTENTS

Features11-17
Specifications & Rimpull11-18
Compaction fundamentals11-19
Bulldozer specifications11-20

Landfill Compactors Features:

- **Choice of Chopper Blades or PLUS TIPS ...** Chopper blades alternate in a staggered-chevron design for maximum coverage and density. PLUS TIPS are standard on 836 — optional on 816F and 826G.
- **Cat designed and manufactured power train ...** for optimum match, performance and efficiency. Responsive Cat diesel Engine. Single-lever planetary power shift. All-wheel drive.
- **Center-point articulation ...** excellent maneuverability. Front and rear drums track, so material is chopped and compacted twice each pass.
- **Protective guarding ...** helps keep trash from damaging machine components.
- **Caterpillar landfill blades** spread refuse and cover material ... built strong to handle the wide range of refuse encountered in landfills.
- **Operator comfort and convenience ...** sound suppressed cab with pressurized and filtered air circulation system. Adjustable suspension seat. Electronic Monitoring System and gauge package is standard. Optional air conditioner available.
- **Striker bars ...** standard on 826G, 836 and 816F, prevents refuse from being carried over the rear wheels.

Landfill Compactors

Specifications

● Rimpull



MODEL	816F		826G		836	
Flywheel Power	164 kW	220 hp	235 kW	315 hp	353 kW	473 hp
Operating Weight*	22 780 kg	50,115 lb	33 350 kg	73,370 lb	44 135 kg	97,300 lb
Engine Model	3306 DITA		3406C DITA		3408	
Rated Engine RPM	2200		2100		2100	
No. Cylinders	6		6		8	
Displacement	10.5 L	638 in³	14.6 L	893 in³	18.0 L	1098 in³
Speeds:						
Forward	4		2		2	
Reverse	4		2		2	
Clearance Turning Circle with Blade	12.8 m	42'2"	14.69 m	48'2"	18.59 m	61'0"
Fuel Tank Refill Capacity	446 L	117.8 U.S. gal	630 L	166.5 U.S. gal	890 L	235 U.S. gal
WHEELS:	CHOPPER		CHOPPER		PLUS-TIPS	
Each Drum Width	1.02 m	3'4"	1.20 m	3'11"	1.40 m	4'7"
Diameters, over Blade Tips	1.60 m	5'3"	1.83 m	6'0"	2.04 m	6'8"
Drum only	1.30 m	4'3"	1.53 m	5'0"	1.72 m	5'8"
Blade Tips per Wheel	20		24		28	
Blade Length	348 mm	13.7"	419 mm	16.5"	294 mm	11.6"
Blade Height	152 mm	6"	152 mm	6"	165 mm	6.5"
Blade Thickness/Width	22 mm	0.87"	28.6 mm	1.125"	150 mm	5.9"
PLUS TIPS per Wheel	20		25		35	
Width of Two Pass Coverage	4.5 m	14'9"	4.78 m	15'8"	5.67 m	18'7"
GENERAL DIMENSIONS:						
Height (to top of ROPS)	3.45 m	11'4"	3.82 m	12'7"	4.57 m	15'0"
Height (stripped top)**	2.50 m	8'3"	2.74 m	9'0"	2.96 m	9'8"
Wheel Base	3.35 m	11'0"	3.70 m	12'2"	3.81 m	12'6"
Overall Length with Dozer	7.79 m	25'7"	8.42 m	27'7"	10.17 m	33'4"
Width over Drums	3.33 m	10'11"	3.80 m	12'6"	4.27 m	14'0"
Ground clearance	532 mm	1'9"	505 mm	1'8"	525 mm	1'8"
LANDFILL BULLDOZER:						
Width	3.65 m	12'0"	4.50 m	14'9"	5.18 m	17'0"
Height***	1.91 m	6'3"	1.90 m	6'3"	2.21 m	7'3"

*Operating Weight includes coolant, bulldozer, hydraulics, ROPS cab, full fuel tank, and operator.

**Height (stripped top) — without ROPS cab, exhaust, seat back or other easily removed encumbrances.

***To top of trash screen.

KEY

- 1 – 1st Gear
- 2 – 2nd Gear
- 3 – 3rd Gear
- 4 – 4th Gear

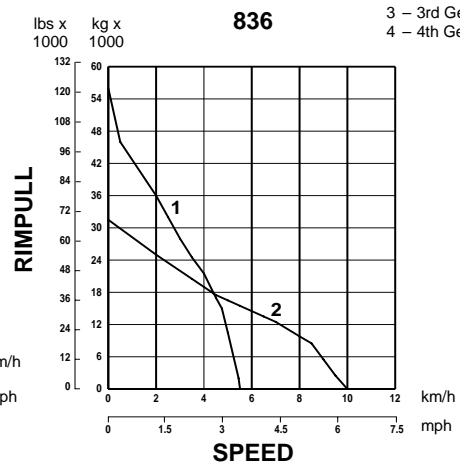
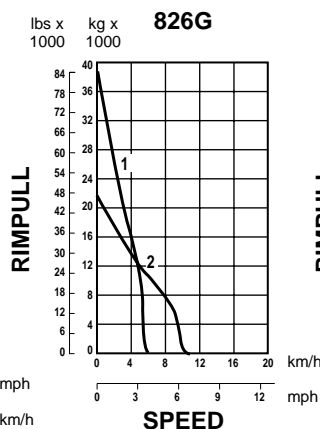
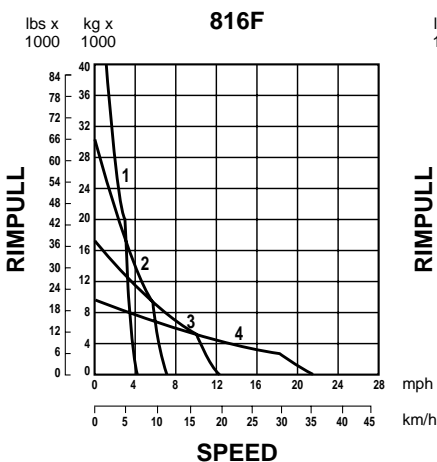

COMPACTION FUNDAMENTALS

To maximize compaction, the following guidelines should be employed when possible:

1. *Refuse Layer Thickness* — The depth of each com-pacted layer is perhaps the single most important controllable factor influencing density. To obtain maximum density efficiency, waste should be spread and compacted in layers **not exceeding a depth of 609 mm (2'0")**. Deeper layers will reduce the density that a machine can develop in a given number of passes. (See top table at right.)
2. *Number of Passes* made over the refuse also affects density. Regardless of what **type** of machine used, the unit should make 3-4 passes to achieve optimum density. The following graph illustrates that more than five passes result in little additional compactive effort. The added expense of additional passes is not justified by the incremental increase in density. (See bottom table at right).
3. *Slope* — To maximize compaction, a compactor should be operated on as flat a slope as possible. This is because the weight of the landfill compactor is more efficiently utilized and concentrated when working on a flat surface. Landfill compactors should never operate on a slope steeper than 4:1.

(Note: Ballasting the wheels on Caterpillar Landfill Compactors to increase machine weight and achieve higher compaction densities is not recommended. Landfills are high rimpull applications. Ballasting the wheels will significantly increase machine weight but decrease overall performance when traveling on the fill. Also, wheels are not necessarily air tight or leak proof. For more landfill discussion please see Waste Disposal section of this handbook.)

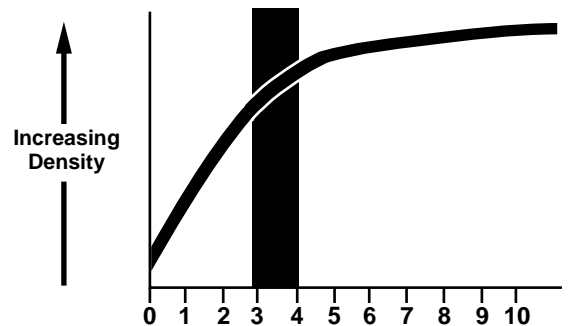
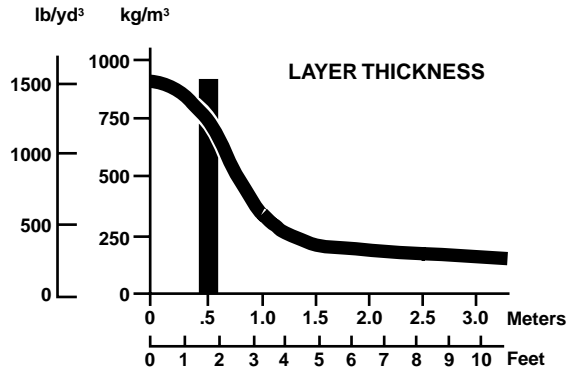

Number of machine passes made with each steel wheel, rubber tire or track.

MODEL	816F		826G		836	
Type	Land Fill Spreading		Land Fill Spreading		Land Fill Spreading	
Capacity**						
Earth	2.90 m ³	3.79 yd³	3.68 m ³	4.81 yd³	5.0 m ³	6.56 yd³
Refuse	10.48 m ³	13.70 yd³	12.74 m ³	16.66 yd³	18.9 m ³	24.66 yd³
Weight, Dozer*	2107 kg	4645 lb	2739 kg	6038 lb	3290 kg	7250 lb
General Dimensions: (Tractor & Dozer)						
Length	7.79 m	25'7"	8.38 m	27'6"	10.17 m	33'4"
Width	3.65 m	12'0"	4.50 m	14'9"	5.18 m	17'0"
Blade Dimensions:						
Width, End Bits	3.65 m	12'0"	4.50 m	14'9"	5.18 m	17'0"
Height, Trash Rack	1915 mm	6'3"	1935 mm	6'4"	2210 mm	7'3"

*Total Bulldozer Arrangement.

**Blade capacities determined by SAE recommended practice J1265.

**BALDERSON
U-BLADE**

	816F		826G		836	
Balderson Model:	BD816UL-12		BD826UL-14		BD836UL-17	
Type	U-Blade		U-Blade		U-Blade	
Blade:						
Capacity (Refuse)	11.9 m ³	15.5 yd³	16.7 m ³	21.9 yd³	25.2 m ³	33 yd³
(Earth)	8.3 m ³	10.8 yd³	12.2 m ³	16 yd³	7.74 m ³	10.13 yd³
Length (Cutting Width)	3658 mm	12'0"	4369 mm	14'4"	5182 mm	17'0"
Height	1857 mm	6'1.1"	2007 mm	6'7"	2210 mm	7'3"
Wing Angle	25°		25°		25°	
Max. lift above ground	889 mm	2'11"	864 mm	2'10"	864 mm	2'10"
Weight, Installed (Without Hydraulics)	1680 kg	3700 lb	2100 kg	4625 lb	4310 kg	9500 lb
					3355 kg	7400 lb

**BALDERSON
W-BLADE**

	816F		826G		836	
Balderson Model:	BD816WL-12		BD826WL-14		BD836WL-17	
Replaces "S" Blade						
Blade:						
Capacity (Refuse)	11.9 m ³	15.5 yd³	16.8 m ³	22.0 yd³	23.9 m ³	31.3 yd³
Length (Cutting Width)	3658 mm	12'0"	4420 mm	14'6"	5207 mm	17'1"
Moldboard Height	1857 mm	6'1.1"	2057 mm	6'9"	2210 mm	7'3"
Weight, Installed (Without Hydraulics)	2070 kg	4560 lb	2975 kg	6600 lb	4515 kg	9950 lb

**BALDERSON
TILT STRAIGHT BLADE**

	816F		826G	
Balderson Model:	BDI816SL-12'T		BDI826SL-14'8"T	
Blade:				
Capacity (Refuse)	10.7 m ³	14.0 yd³	13.0 m ³	17.0 yd³
Length (Cutting Width)	3647 mm	11'11.6"	4375 mm	14'4.3"
Weight, Installed	2225 kg	4500 lb	3530 kg	7780 lb

WHEEL LOADERS

WASTE HANDLING WHEEL LOADERS

CONTENTS

WHEEL LOADERS

Features	12-1
Specifications	12-2
Performance data	12-6
Machine dimensions	12-31
SAE loader ratings	12-37
Machine selection:	
Cycle time factors	12-39
Truck loading	12-40
Bucket fill factors	12-40
Example problem	12-41
Alternative method of selection	12-42
Nomographs	12-43
Bucket selection	12-45
Estimated haul or return time charts	12-49
Travel time charts	12-50
Production estimating tables:	
Cubic meters and cubic yards	12-70
Metric tons and U.S. tons in shot rock	12-71
Attachments	12-73
Waste handling wheel loaders	12-75

WHEEL LOADERS

Features:

- **Caterpillar large displacement, heavy duty diesel engine.**
- **Productive operator environment. Excellent visibility.**
- **Automatic lift and bucket controls.**
- **Adjustable suspension seat and steering column.**
- **Four wheel enclosed wet disc brakes.**
- **Automatic power shift transmissions.** Allows operator to select automatic or manual mode.
- **Hydrostatic drive on 902, 906 and 914G.**
- **Transmission neutralizer switch.**
- **Centerpoint articulated frame steering.**
- **Computerized machine function monitoring.**
- **Variable capacity torque converter on 988F Series II and 992G.**
- **Command control steering** with integrated transmission controls.
- **Lock up clutch on 990 and 994 (optional on 988F).**
- **Impeller clutch on 994.**
- **Limited slip differentials.**
- **Traction control system...938G.**
- **Automatic Ride Control suspension system.** Operator select "on", "off" or "automatic".
- **Payload control system.**

Listed features may be standard on some models, optional or unavailable on others. Contact your Caterpillar Dealer for specific information.



MODEL	902		906		914G		924F	
Flywheel Power: Net	34 kW	45 hp	45 kW	60 hp	67 kW	90 hp	78 kW	105 hp
Gross	36 kW	48 hp	47 kW	63 hp	—	—	—	—
Engine Model	3024		3034		3054T		3114T	
Rated Engine RPM	2600		2600		2200		2400	
Bore	84 mm	3.31"	97 mm	3.82"	100 mm	3.94"	105 mm	4.13"
Stroke	100 mm	3.94"	100 mm	3.94"	127 mm	5"	127 mm	5"
No. Cylinders	4		4		4		4	
Displacement	2.2 L	135 in³	2.95 L	180 in³	4 L	243 in³	4.4 L	268 in³
Speeds Forward	km/h	mph	km/h	mph	km/h	mph	km/h	mph
1st	7	Lo 4	8	Lo 5	7	Lo* 4.3	7.1	4.4
2nd	20	Hi 12	20	Hi 12	20	Lo 12.4	13.1	8.2
3rd	—	—	—	—	9	Hi** 5.6	23.6	14.8
4th	—	—	—	—	35	Hi 21.7	38.2	23.9
Speeds Reverse								
1st	7	Lo 4	8	Lo 5	7	Lo* 4.3	7.1	4.4
2nd	20	Hi 12	20	Hi 12	20	Lo 12.4	13.1	8.2
3rd	—	—	—	—	9	Hi** 5.6	23.6	14.8
4th	—	—	—	—	35	Hi 21.7	—	—
Hydraulic Cycle Time, Rated Load in Bucket:	Seconds		Seconds		Seconds		Seconds	
Raise	4.5		4.5		5.6		4.3	
Dump	1.5		1.5		2.1		1.3	
Lower (Empty, Float Down)	3.2		3.2		3.2		2.7	
Total	9.2		9.2		10.9		8.3	
Tread Width	1.35 m	4'5"	1.40 m	4'7"	1.80 m	5'11"	1.85 m	6'1"
Width Over Tires	1.70 m	5'7"	1.82 m	6'0"	2.26 m	7'5"	2.32 m	7'7.7"
Ground Clearance	385 mm	15"	420 mm	17"	456 mm	18"	318 mm	12.5"
Fuel Tank Capacity	74 L	19.6 U.S. gal	74 L	19.6 U.S. gal	150 L	39.6 U.S. gal	157 L	41.5 U.S. gal
Hydraulic Tank Capacity	49 L	13 U.S. gal	49 L	13 U.S. gal	70 L	18.5 U.S. gal	53 L	14 U.S. gal
Hydraulic System Capacity (includes tank)	66 L	17.5 U.S. gal	66 L	17.5 U.S. gal	100 L	26.4 U.S. gal	77 L	20.3 U.S. gal

*Hydrostatic transmission standard speed version.

**Hydrostatic transmission high speed version.



MODEL	928G		938G		950G		962G	
Flywheel Power: Net	93 kW	125 hp	108 kW	145 hp	134 kW	180 hp	149 kW	200 hp
Gross	—		118 kW	158 hp	140 kW	185 hp	154 kW	207 hp
Engine Model	3116T		3126TA		3126TA		3126TA	
Rated Engine RPM	2300		2200		2200		2200	
Bore	105 mm	4.13"	110 mm	4.3"	110 mm	4.3"	110 mm	4.3"
Stroke	127 mm	5"	127 mm	5"	127 mm	5"	127 mm	5"
No. Cylinders	6		6		6		6	
Displacement	6.6 L	403 in³	7.2 L	439 in³	7.2 L	439 in³	7.2 L	439 in³
Speeds Forward	km/h	mph	km/h	mph	km/h	mph	km/h	mph
1st	7.6	4.7	7	4.3	6.9	4.3	6.9	4.3
2nd	12	7.5	12.7	7.9	12.7	7.9	12.7	7.9
3rd	24.6	15.3	21.9	13.6	22.3	13.9	22.3	13.9
4th	36.7	22.8	35.9	22.3	37	23	37	23.0
Speeds Reverse								
1st	7.6	4.7	7	4.3	7.6	4.7	7.6	4.7
2nd	12	7.5	12.7	7.9	13.9	8.7	13.9	8.7
3rd	24.6	15.3	21.9	13.6	24.5	15.3	24.5	15.3
4th	—		—		40.5	25.3	40.5	25.3
Hydraulic Cycle Time, Rated Load in Bucket:	Seconds		Seconds		Seconds		Seconds	
Raise	6.1		6		6.3		6.3	
Dump	1.2		1.4		2.2		2.2	
Lower (Empty, Float Down)	2.8		2.8		2.2		2.2	
Total	10.1		10.2		10.7		10.7	
Tread Width	1.82 m	6'1"	2.02 m	6'8"	2.14 m	7'0"	2.14 m	7'0"
Width Over Tires	2.44 m	8'0"	2.60 m	8'6"	2.89 m	9'6"	2.89 m	9'6"
Ground Clearance	408 mm	16"	400 mm	15.7"	400 mm	15.7"	400 mm	15.7"
Fuel Tank Capacity	230 L	60.8 U.S. gal	254 L	67 U.S. gal	295 L	78 U.S. gal	295 L	78 U.S. gal
Hydraulic Tank Capacity	70 L	18.5 U.S. gal	55 L	14.5 U.S. gal	88 L	23.2 U.S. gal	88 L	23.2 U.S. gal
Hydraulic System Capacity (includes tank)	125 L	33 U.S. gal	90 L	23.8 U.S. gal	153 L	40.4 U.S. gal	153 L	40.4 U.S. gal



MODEL	966F Series II		970F		980G		988F Series II	
Flywheel Power	164 kW	220 hp	187 kW	250 hp	224 kW	300 hp	321 kW	430 hp
Engine Model	3306TA		3306TA		3406TA		3408E TA	
Rated Engine RPM	2200		2200		2100		2000	
Bore	121 mm	4.75"	121 mm	4.75"	137 mm	5.4"	137 mm	5.4"
Stroke	152 mm	6"	152 mm	6"	165 mm	6.5"	152 mm	6"
No. Cylinders	6		6		6		8	
Displacement	10.5 L	638 in³	10.5 L	638 in³	14.6 L	893 in³	18 L	1099 in³
Speeds Forward	km/h	mph	km/h	mph	km/h	mph	km/h	mph
1st	7.3	4.5	7.2	4.5	7	4.3	6.9	4.3
2nd	13	8.1	12.6	7.8	12.3	7.7	12.1	7.5
3rd	22.5	14	21.7	13.5	21.6	13.4	20.7	12.8
4th	38.8	24.1	37.3	23.2	37.4	23.2	35.1	21.8
Speeds Reverse								
1st	8.3	5.2	8.2	5.1	8	5	7.9	4.9
2nd	14.8	9.2	14.4	8.9	14	8.8	13.7	8.5
3rd	25.6	15.9	24.6	15.3	24.6	15.3	23.5	14.6
4th	43.9	27.3	42.7	26.5	42.8	26.6	—	
Hydraulic Cycle Time, Rated Load in Bucket:	Seconds		Seconds		Seconds		Seconds	
Raise	7.1		6.1		6		7.9	
Dump	2		1.3		2		3.3	
Lower (Empty, Float Down)	2.4		2.1		3.4		4.0	
Total	11.5		9.5		11.4		15.2	
Tread Width	2.20 m	7'3"	2.20 m	7'3"	2.44 m	8'0"	2.59 m	8'6"
Width Over Tires	2.94 m	9'8"	2.94 m	9'8"	3.25 m	10'8"	3.52 m	11'7"
Ground Clearance	476 mm	18.7"	482 mm	1'7"	467 mm	18.4"	496 mm	1'7"
Fuel Tank Capacity	377 L	99.6 U.S. gal	377 L	99.6 U.S. gal	470 L	124 U.S. gal	659 L	174 U.S. gal
Hydraulic Tank Capacity	140 L	37 U.S. gal	140 L	37 U.S. gal	125 L	33 U.S. gal	235 L	62 U.S. gal
Hydraulic System Capacity (includes tank)	205 L	54 U.S. gal	205 L	54 U.S. gal	208 L	55 U.S. gal	295 L	78 U.S. gal

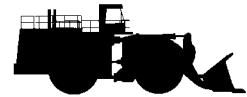

MODEL	990 Series II		992G		994	
Flywheel Power	466 kW	625 hp	597 kW	800 hp	932 kW	1250 hp
Engine Model	3412E TA		3508B TA		3516TA	
Rated Engine RPM	2000		1750		1600	
Bore	137 mm	5.4"	170 mm	6.7"	170 mm	6.69"
Stroke	152 mm	6"	190 mm	7.5"	190 mm	7.48"
No. Cylinders	12		8		16	
Displacement	27 L	1649 in ³	34.5 L	2105 in ³	69 L	4211 in ³
Speeds Forward	km/h	mph	km/h	mph	km/h	mph
1st	7.2	4.5	6.7	4.2	6.8	4.2
2nd	12.9	8	11.9	7.3	12.2	7.6
3rd	22.5	14	20.2	12.5	21.2	13.2
Speeds Reverse						
1st	8	5	7.4	4.6	7.6	4.7
2nd	14.2	8.8	12.6	7.8	14	8.7
3rd	25	15.5	22.7	14.1	24.3	15.1
Hydraulic Cycle Time, Rated Load in Bucket:	Seconds		Seconds		Seconds	
Raise	9.2		9.12		12.5	
Dump	2.9		3.26		3.4	
Lower (Empty, Float Down)	3.8		3.47		4.2	
Total	15.9		15.85		20.1	
Tread Width	3.1 m	10'0"	3.30 m	10'10"	3.90 m	12'10"
Width Over Tires	4.1 m	13'6"	4.50 m	14'9"	5.20 m	17'0"
Ground Clearance	507 mm	20"	691 mm	27"	650 mm	25.6"
Fuel Tank Capacity	970 L	252 U.S. gal	1319 L	343 U.S. gal	4540 L	1200 U.S. gal
Hydraulic Tank Capacity	174 L**	45 U.S. gal	326 L†	84.8 U.S. gal	623 L*	165 U.S. gal
Hydraulic System Capacity (includes tank)	435 L**	113 U.S. gal	646 L†	168 U.S. gal	723 L*	190 U.S. gal

*Separate steering system 265 L (70 U.S. gal). Brakes 42 L (11 U.S. gal).

**Also contains separate systems for steering and engine cooling fan 193 L (51 U.S. gal), tank only 129 L (34 U.S. gal).

†Separate steering and fan system 227 L (60 U.S. gal). Tank only 156 L (41.3 U.S. gal).

Bucket Type		General Purpose					Multi-Purpose			
		Bare	Bolt-on Edge	Bolt-on Teeth	Weld-on Edge	Pin-on Tips	Bare	Bolt-on Edge	Bolt-on Teeth	Weld-on Edge
Rated bucket capacity (\$)	m ³ yd ³	0.6 0.78	0.6 0.78	0.6 0.78	0.7 0.78	0.6 0.78	0.6 0.78	0.6 0.78	0.6 0.78	0.7 0.78
Struck capacity (\$)	m ³ yd ³	0.5 0.65	0.5 0.65	0.5 0.65	0.5 0.65	0.5 0.65	0.5 0.65	0.5 0.65	0.5 0.65	0.5 0.65
Width	mm ft/in	1780 5'10"	1790 5'10"	1780 5'10"	1790 5'10"	1780 5'10"	1790 5'10"	1790 5'10"	1790 5'10"	1790 5'10"
Dump clearance at full lift and 43° discharge (\$)	mm ft/in	2341 7'8"	2307 7'7"	2341 7'8"	2273 7'5"	2341 7'8"	2341 7'8"	2307 7'7"	2341 7'8"	2273 7'5"
Reach at full lift and 43° discharge (\$)	mm ft/in	751 2'6"	764 2'6"	751 2'6"	801 2'7"	751 2'6"	751 2'6"	764 2'6"	751 2'6"	801 2'7"
Reach at 45° discharge and 2130 mm (7'0") clearance (\$)	mm ft/in	920 3'0"	902 3'0"	856 2'10"	905 3'0"	839 2'9"	920 3'0"	902 3'0"	856 2'10"	905 3'0"
Reach with lift arms horizontal and bucket level	mm ft/in	1779 5'10"	1811 5'11"	1779 5'10"	1862 6'1"	1779 5'10"	1779 5'10"	1811 5'11"	1779 5'10"	1882 6'2"
Digging depth (\$)	mm in	52 2"	68 2.7"	52 2"	68 2.7"	52 2"	52 2"	68 2.7"	52 2"	68 2.7"
Overall length	mm ft/in	5155 16'11"	5200 17'1"	5155 16'11"	5251 17'3"	5155 16'11"	5155 16'11"	5200 17'1"	5155 16'11"	5251 17'3"
Overall height with bucket at full raise (\$)	mm ft/in	3967 13'0"	3967 13'0"	3967 13'0"	3967 13'0"	3967 13'0"	3944 12'11"	3944 12'11"	3944 12'11"	3944 12'11"
Loader clearance circle with bucket in carry position	mm ft/in	7724 25'4"	7764 25'6"	7724 25'4"	7792 25'7"	7724 25'4"	7732 25'4"	7792 25'7"	7732 25'4"	7804 25'7"
Static tipping load, straight* (\$)	kg lb	3040 6700	2983 6570	3022 6660	2955 6510	3012 6640	2788 6140	2732 6020	2771 6110	2706 5960
Static tipping load, full 43° turn* (\$)	kg lb	2551 5620	2496 5500	2533 5580	2472 5450	2523 5560	2308 5080	2254 4970	2289 5040	2231 4910
Breakout force (\$)	kN lb	36.4 8190	34.7 7800	36.3 8160	32.1 7220	36.2 8140	35.6 8010	33.6 7560	35.4 7960	31.4 7060
Operating weight*	kg lb	4452 9820	4487 9890	4467 9850	4492 9900	4475 9870	4685 10,330	4720 10,410	4700 10,360	4721 10,410

*Static tipping load and operating weights shown are with implements, ROPS cab, 12.5-18 tires, full fuel tank and operator.

NOTE: Specifications and ratings conform to all applicable standards recommended by the Society of Automotive Engineers (SAE). SAE Standards J732 JUN92 and J742 FEB85 govern loader rating, denoted in the text by (\$).

	Change in Operating Weight		Change in Articulated Static Tipping Load	
	kg	lb	kg	lb
Limited slip rear axle	0	0	0	0
Enclosed ROPS (Comfort)	+ 2	+ 4	+ 1	+ 2
Enclosed ROPS (Deluxe)	+ 5	+ 11	+ 4	+ 9
Boom with load check valves	+ 12	+ 26	+ 2	+ 4
Third valve hydraulics	+ 11	+ 24	- 1	- 2
Counterweight	+ 110	+ 243	+ 113	+ 249
Wheel chock	+ 5	+ 11	+ 2	+ 4
Tool roll	+ 4	+ 9	+ 4	+ 9

Bucket Type	Multi-Purpose	High Dump			Light Material		Stone Sieve			
		Pin-on Tips	Bare	Bolt-on Edge	Bolt-on Teeth	Bare	Bolt-on Edge	Bare	Bolt-on Edge	Bolt-on Teeth
Ground Engaging Type										
Rated bucket capacity (\$)	m ³ yd ³	0.6 0.78	0.6 0.78	0.6 0.78	0.6 0.78	1 1.3	1 1.3	0.6 0.78	0.6 0.78	0.6 0.78
Struck capacity (\$)	m ³ yd ³	0.5 0.65	0.5 0.65	0.5 0.65	0.5 0.65	0.8 1.05	0.8 1.05	0.5 0.65	0.5 0.65	0.5 0.65
Width	mm ft/in	1790 5'10"	1887 6'2"	1787 5'10"	1787 5'10"	1880 6'2"	1890 6'2"	1780 5'10"	1780 5'10"	1780 5'10"
Dump clearance at full lift and 43° discharge (\$)	mm ft/in	2341 7'8"	2341 7'8"	2307 7'7"	2341 7'8"	2204 7'3"	2170 7'1"	2341 7'8"	2307 7'7"	2341 7'8"
Reach at full lift and 43° discharge (\$)	mm ft/in	844 2'9"	717 2'4"	728 2'5"	788 2'7"	856 2'10"	867 2'10"	717 2'4"	728 2'5"	788 2'7"
Reach at 43° discharge and 2130 mm (7'0") clearance (\$)	mm ft/in	929 3'1"	920 3'0"	902 3'0"	928 3'1"	929 3'1"	904 3'0"	920 3'0"	902 3'0"	928 3'1"
Reach with lift arms horizontal and bucket level	mm ft/in	1906 6'3"	1779 5'10"	1811 5'11"	1881 5'11"	1979 6'6"	2011 6'7"	1779 5'10"	1811 5'11"	1881 6'2"
Digging depth (\$)	mm in	52 2"	52 2"	68 2.7"	52 2"	52 2"	69 2.7"	52 2"	68 2.7"	52 2"
Overall length	mm ft/in	5282 17'4"	5155 16'11"	5200 17'1"	5257 17'3"	5355 17'7"	5400 17'9"	5155 16'11"	5200 17'1"	5257 17'3"
Overall height with bucket at full raise (\$)	mm ft/in	3944 12'11"	3967 13'0"	3967 13'0"	3967 13'0"	3944 12'11"	3944 12'11"	3816 12'6"	3816 12'6"	3816 12'6"
Loader clearance circle with bucket in carry position	mm ft/in	7752 25'5"	7724 25'4"	7764 25'6"	7724 25'4"	7934 26'0"	7974 26'2"	7724 25'4"	7764 25'6"	7724 25'4"
Static tipping load, straight* (\$)	kg lb	2763 6090	2788 6140	2818 6210	2859 6300	2962 6530	2900 6390	2985 6580	2924 6440	2940 6480
Static tipping load, full turn* (\$)	kg lb	2282 5030	2386 5260	2329 5130	2368 5220	2473 5450	2414 5320	2498 5500	2439 5370	2452 5400
Breakout force (\$)	kN lb	35.3 7940	35.3 7940	33.3 7490	35.1 7890	27.5 6180	23.6 5310	36.3 8160	34.3 7710	35.8 8050
Operating weight*	kg lb	4704 10,370	4639 10,230	4674 10,310	4654 10,260	4531 9990	4568 10,070	4509 9940	4544 10,020	4552 10,040

*Static tipping load and operating weights shown are with implements, ROPS cab, 12.5-18 tires, full fuel tank and operator.
NOTE: Specifications and ratings conform to all applicable standards recommended by the Society of Automotive Engineers (SAE). SAE Standards J732 JUN92 and J742 FEB85 govern loader rating, denoted in the text by (\$).

	Change in Operating Weight		Change in Articulated Static Tipping Load	
	kg	lb	kg	lb
Limited slip rear axle	0	0	0	0
Enclosed ROPS (Comfort)	+ 2	+ 4	+ 1	+ 2
Enclosed ROPS (Deluxe)	+ 5	+ 11	+ 4	+ 9
Boom with load check valves	+ 12	+ 26	+ 2	+ 4
Third valve hydraulics	+ 11	+ 24	- 1	- 2
Counterweight	+ 110	+ 243	+ 113	+ 249
Wheel chock	+ 5	+ 11	+ 2	+ 4
Tool roll	+ 4	+ 9	+ 4	+ 9

Bucket Type		General Purpose					Multi-Purpose			
		Bare	Bolt-on Edge	Bolt-on Teeth	Weld-on Edge	Pin-on Tips	Bare	Bolt-on Edge	Bolt-on Teeth	
Ground Engaging Type	Rated bucket capacity (\$)	m ³ yd ³	0.8 1.05	0.8 1.05	0.8 1.05	0.9 1.18	0.8 1.05	0.8 1.05	0.8 1.05	
	Struck capacity (\$)	m ³ yd ³	0.6 0.78	0.7 0.92	0.6 0.78	0.7 0.92	0.6 0.78	0.6 0.78	0.6 0.78	
Width	Dump clearance at full lift and 43° discharge (\$)	mm	1880	1890	1880	1890	1880	1890	1890	
		ft/in	6'2"	6'2"	6'2"	6'2"	6'2"	6'2"	6'2"	
Reach at full lift and 43° discharge (\$)	Reach at 43° discharge and 2130 mm (7'0") clearance (\$)	mm	829	842	901	879	922	829	842	904
		ft/in	2'9"	2'9"	2'11"	2'11"	3'0"	2'9"	2'9"	3'0"
Reach with lift arms horizontal and bucket level	Digging depth (\$)	mm	1070	982	1142	1118	1160	1071	1045	1143
		ft/in	3'6"	3'3"	3'9"	3'8"	3'10"	3'7"	3'5"	3'9"
Overall length	Overall height with bucket at full raise (\$)	mm	1912	1945	2014	1995	2040	1912	1945	2014
		ft/in	6'3"	6'5"	6'7"	6'6"	6'8"	6'3"	6'5"	6'7"
Loader clearance circle with bucket in carry position	Static tipping load, straight* (\$)	mm	84	100	84	100	84	84	99	84
		in	3.31	3.94	3.31	3.94	3.31	3.31	3.90	3.31
Static tipping load, full turn* (\$)	Breakout force (\$)	mm	5310	5355	5412	5405	5437	5309	5354	5411
		ft/in	17'5"	17'7"	17'9"	17'9"	17'10"	17'5"	17'7"	17'9"
Operating weight*	Counterweight (standard) removed	mm	4170	4170	4170	4170	4170	4205	4205	4205
		ft/in	13'8"	13'8"	13'8"	13'8"	13'8"	13'10"	13'10"	13'10"
Wheel chock	Counterweight 150 kg (330 lb)	mm	8330	8368	8330	8394	8330	8330	8358	8330
		ft/in	27'4"	27'5"	27'4"	27'6"	27'4"	27'4"	27'5"	27'4"
Tool roll	Wheel chock	kg	3427	3382	3410	3374	3399	3234	3169	3215
		lb	7550	7450	7510	7430	7490	7130	6980	7080
Tool roll	Wheel chock	kg	2962	2917	2944	2909	2934	2765	2702	2746
		lb	6530	6430	6490	6410	6460	6090	5950	6050
Tool roll	Wheel chock	kN	45.4	43.2	45.3	40.4	45.2	44.5	42.3	44.3
		lb	10,210	9720	10,190	9090	10,170	10,010	9510	9960
Tool roll	Wheel chock	kg	5096	5131	5110	5138	5118	5343	5379	5357
		lb	11,240	11,310	11,270	11,330	11,290	11,780	11,860	11,810

*Static tipping load and operating weights shown are with implements, ROPS cab, 12.5-20 tires, full fuel tank, operator and 80 kg (176 lb) counterweight.

NOTE: Specifications and ratings conform to all applicable standards recommended by the Society of Automotive Engineers (SAE). SAE Standards J732 JUN92 and J742 FEB85 govern loader rating, denoted in the text by (\$).

	Change in Operating Weight		Change in Articulated Static Tipping Load	
	kg	lb	kg	lb
Limited slip rear axle	0	0	0	0
Enclosed ROPS (Comfort)	+ 2	+ 4	+ 1	+ 2
Enclosed ROPS (Deluxe)	+ 5	+ 11	+ 4	+ 9
Boom with load check valves	+ 12	+ 26	+ 2	+ 4
Third valve hydraulics	+ 11	+ 24	- 1	- 2
Counterweight (standard) removed	- 80	-176	-112	-247
Counterweight 150 kg (330 lb)	+ 150	+ 331	+ 151	+ 333
Wheel chock	+ 5	+ 11	+ 2	+ 4
Tool roll	+ 4	+ 9	+ 4	+ 9

Bucket Type		Multi-Purpose		High Dump			Side Dump		
		Weld-on Edge	Pin-on Tips	Bare	Bolt-on Edge	Bolt-on Teeth	Bare	Bolt-on Edge	Bolt-on Teeth
Ground Engaging Type	Rated bucket capacity (\$)	m ³	0.8	0.8	0.7	0.7	0.7	0.7	0.7
		yd ³	1.05	1.05	0.92	0.92	0.92	0.92	0.92
Struck capacity (\$)		m ³	0.7	0.6	0.6	0.6	0.5	0.6	0.5
		yd ³	0.92	0.78	0.78	0.78	0.65	0.78	0.65
Width		mm	1890	1890	1887	1887	1887	1880	1880
		ft/in	6'2"	6'2"	6'2"	6'2"	6'2"	6'2"	6'2"
Dump clearance at full lift and 43° discharge (\$)		mm	2357	2425	2425	2391	2425	2322	2288
		ft/in	7'9"	7'11"	7'11"	7'11"	7'11"	7'7"	7'6"
Reach at full lift and 43° discharge (\$)		mm	879	923	829	842	904	938	951
		ft/in	2'11"	3'0"	2'9"	2'9"	3'0"	3'1"	3'1"
Reach at 43° discharge and 2130 mm (7'0") clearance (\$)		mm	1061	1161	1070	1039	1082	1087	1067
		ft/in	3'6"	3'10"	3'6"	3'5"	3'7"	3'7"	3'6"
Reach with lift arms horizontal and bucket level		mm	1995	2040	1912	1945	2015	2062	2095
		ft/in	6'7"	6'8"	6'3"	6'4"	6'7"	6'9"	6'10"
Digging depth (\$)		mm	99	84	84	100	84	84	100
		in	3.90	3.31	3.31	3.94	3.31	3.31	3.94
Overall length		mm	5405	5437	5310	5355	5412	5461	5505
		ft/in	17'9"	17'10"	17'5"	17'7"	17'9"	17'11"	18'1"
Overall height with bucket at full raise (\$)		mm	4205	4205	4212	4212	4212	4211	4211
		ft/in	13'10"	13'10"	13'10"	13'10"	13'10"	13'10"	13'10"
Loader clearance circle with bucket in carry position		mm	8386	8330	8366	8404	8366	8412	8442
		ft/in	27'6"	27'4"	27'5"	27'7"	27'5"	27'7"	27'8"
Static tipping load, straight* (\$)		kg	3147	3205	3252	3188	3234	3038	2979
		lb	6930	7060	7170	7020	7130	6690	6560
Static tipping load, full turn* (\$)		kg	2684	2736	2787	2725	2768	2598	2540
		lb	5910	6030	6140	6000	6100	5720	5600
Breakout force (\$)		kN	39.5	44.2	44.3	42	44.1	36.3	34.6
		lb	8880	9940	9960	9450	9920	8160	7780
Operating weight*		kg	5380	5365	5279	5316	5294	5318	5355
		lb	11,860	11,830	11,640	11,720	11,670	11,730	11,810

*Static tipping load and operating weights shown are with implements, ROPS cab, 12.5-20 tires, full fuel tank, operator and 80 kg (176 lb) counterweight.

NOTE: Specifications and ratings conform to all applicable standards recommended by the Society of Automotive Engineers (SAE). SAE Standards J732 JUN92 and J742 FEB85 govern loader rating, denoted in the text by (\$).

	Change in Operating Weight		Change in Articulated Static Tipping Load	
	kg	lb	kg	lb
Limited slip rear axle	0	0	0	0
Enclosed ROPS (Comfort)	+ 2	+ 4	+ 1	+ 2
Enclosed ROPS (Deluxe)	+ 5	+ 11	+ 4	+ 9
Boom with load check valves	+ 12	+ 26	+ 2	+ 4
Third valve hydraulics	+ 11	+ 24	- 1	- 2
Counterweight (standard) removed	- 80	-176	-112	-247
Counterweight 150 kg (330 lb)	+ 150	+ 331	+ 151	+ 333
Wheel chock	+ 5	+ 11	+ 2	+ 4
Tool roll	+ 4	+ 9	+ 4	+ 9

Bucket Type		Light Material		Stone Sieve		
		Bare	Bolt-on Edge	Bare	Bolt-on Edge	Bolt-on Teeth
Ground Engaging Type						
	Rated bucket capacity (\$)	m ³ yd ³	1.2 1.57	1.2 1.57	0.7 0.92	0.7 0.92
Struck capacity (\$)						
		m ³ yd ³	1.0 1.31	1.0 1.31	0.5 0.65	0.6 0.78
Width						
		mm ft/in	1950 6'5"	1970 6'6"	1880 6'2"	1880 6'2"
Dump clearance at full lift and 43° discharge (\$)						
		mm ft/in	2281 7'6"	2247 7'4"	2425 7'11"	2391 7'10"
Reach at full lift and 43° discharge (\$)						
		mm ft/in	982 3'3"	995 3'3"	829 2'9"	842 2'9"
Reach at 43° discharge and 2130 mm (7'0") clearance (\$)						
		mm ft/in	1090 3'7"	1068 3'6"	1070 3'6"	1054 3'5"
Reach with lift arms horizontal and bucket level						
		mm ft/in	2122 7'0"	2155 7'1"	1912 6'3"	1945 6'5"
Digging depth (\$)						
		mm in	84 3.31	100 3.94	84 3.31	100 3.94
Overall length						
		mm ft/in	5520 18'1"	5565 18'3"	5310 17'5"	5355 17'7"
Overall height with bucket at full raise (\$)						
		mm ft/in	4314 14'2"	4314 14'2"	4037 13'3"	4037 13'3"
Loader clearance circle with bucket in carry position						
		mm ft/in	8506 27'11"	8556 28'11"	8328 27'4"	8358 27'5"
Static tipping load, straight* (\$)						
		kg lb	3327 7330	3263 7190	3353 7390	3286 7240
Static tipping load, full turn* (\$)						
		kg lb	2864 6310	2802 6170	2892 6370	2828 6230
Breakout force (\$)						
		kN lb	34.5 7760	33 7420	45.3 10,190	43 9670
Operating weight*						
		kg lb	5178 11,420	5216 11,500	5149 11,350	5188 11,440

*Static tipping load and operating weights shown are with implements, ROPS cab, 12.5-20 tires, full fuel tank, operator and 80 kg (176 lb) counterweight.

NOTE: Specifications and ratings conform to all applicable standards recommended by the Society of Automotive Engineers (SAE). SAE Standards J732 JUN92 and J742 FEB85 govern loader rating, denoted in the text by (\$).

	Change in Operating Weight		Change in Articulated Static Tipping Load	
	kg	lb	kg	lb
Limited slip rear axle	0	0	0	0
Enclosed ROPS (Comfort)	+ 2	+ 4	+ 1	+ 2
Enclosed ROPS (Deluxe)	+ 5	+ 11	+ 4	+ 9
Boom with load check valves	+ 12	+ 26	+ 2	+ 4
Third valve hydraulics	+ 11	+ 24	- 1	- 2
Counterweight (standard) removed	- 80	-176	-112	-247
Counterweight 150 kg (330 lb)	+ 150	+ 331	+ 151	+ 333
Wheel chock	+ 5	+ 11	+ 2	+ 4
Tool roll	+ 4	+ 9	+ 4	+ 9

Bucket Type	Ground Engaging Type	General Purpose						Penetration	
		Bolt-on Cutting Edge		Bolt-on Teeth & Segments		Bolt-on Teeth		Flush Mounted Teeth	
Rated bucket capacity (\$)	m ³ yd ³	1.3 1.7	1.4 1.8	1.3 1.7	1.4 1.8	1.2 1.6	1.3 1.7	1.3 1.7	1.4 1.8
Struck capacity (\$)	m ³ yd ³	1.1 1.4	1.2 1.5	1.1 1.4	1.2 1.5	1 1.3	1.1 1.5	1.1 1.5	1.2 1.5
Width	mm ft/in	2401 7'10.5"	2401 7'10.5"	2424 7'11.4"	2424 7'11.4"	2424 7'11.4"	2424 7'11.4"	2434 7'11.8"	2434 7'11.8"
Dump clearance at full lift and 45° discharge (\$)	mm ft/in	2658 8'9"	2623 8'7"	2658 8'9"	2630 8'7"	2714 8'11"	2679 8'10"	2679 8'10"	2679 8'10"
Reach at full lift and 45° discharge (\$)	mm ft/in	973 3'2"	1008 3'4"	966 3'2"	1001 3'3"	943 3'1"	979 3'3"	979 3'3"	979 3'3"
Reach at 45° discharge and 2130 mm (7'0") clearance (\$)	mm ft/in	1330 4'4"	1348 4'5"	1282 4'2"	1297 4'3"	1259 4'2"	1275 4'2"	1287 4'3"	1249 4'1"
Reach with lift arms horizontal and bucket level	mm ft/in	1980 6'6"	2030 6'8"	1970 6'6"	2020 6'8"	1920 6'4"	1970 6'6"	1970 6'6"	1970 6'6"
Digging depth (\$)	mm in	89 3.5"	89 3.5"	89 3.5"	89 3.5"	70 2.8"	70 2.8"	70 2.8"	70 2.8"
Overall length	mm ft/in	6229 20'5"	6279 20'7"	6328 20'9"	6378 20'11"	6310 20'8"	6360 20'10"	6358 20'10"	6438 21'1"
Overall height with bucket at full raise (\$)	mm ft/in	4390 14'5"	4442 14'7"	4390 14'5"	4442 14'7"	4390 14'5"	4442 14'7"	4442 14'7"	4442 14'7"
Loader clearance circle with bucket in carry position	m ft/in	10.34 33'11"	10.37 34'0"	10.42 34'2"	10.45 34'4"	10.42 34'2"	10.45 34'4"	10.44 34'3"	10.49 34'5"
Static tipping load, straight* (\$)	kg lb	5869 12,912	5840 12,848	5830 12,826	5800 12,760	5965 13,123	5935 13,057	5953 13,097	5774 12,703
Static tipping load, full 40° turn* (\$)	kg lb	5123 11,270	5095 11,209	5084 11,185	5056 11,123	5213 11,468	5185 11,407	5203 11,447	5024 11,053
Breakout force (\$)	kg lb	6367 14,007	5971 13,136	6415 14,113	6010 13,222	6930 15,246	6469 14,232	6484 14,265	6359 13,983
Operating weight*	kg lb	7198 15,836	7211 15,864	7230 15,906	7243 15,935	7157 15,745	7170 15,744	7156 15,743	7321 16,106

*Static tipping load and operating weights shown are for high-speed version 914G and include lubricants, full fuel tank, ROPS cab, 80 kg (176 lb) operator and 17.5-R25 (L2 equivalent) tires.

NOTE: Specifications and ratings conform to all applicable standards recommended by the Society of Automotive Engineers (SAE). SAE Standards J732 JUN92 and J742 FEB85 govern loader rating, denoted in the text by (\$).

	Change in Operating Weight		Change in Articulated Static Tipping Load	
	kg	lb	kg	lb
Air conditioner	+ 55	+ 121	+ 71	+ 156
Canopy, ROPS (less cab)	-199	-438	-174	-383
Counterweight, 150 kg (330 lb)	+ 152	+ 334	+ 287	+ 631
Ride control	+ 32	+ 70	+ 6	+ 13
Standard speed version machine	- 70	-154	- 74	-163
Supplemental steering	+ 30	+ 66	+ 44	+ 97
Tires & rims, 15.5-25, 12 PR (L-2)	-127	-280	- 79	-174
Tires & rims, 15.5-25, 12 PR (L-3)	- 78	-172	- 48	-106
Tires & rims, 15.5-R25, radial (L-2 equivalent)	- 84	-185	- 52	-114
Tires & rims, 15.5-R25, radial (L-3 equivalent)	- 36	- 79	- 23	- 51
Tires & rims, 17.5-25, 12 PR (L-2)	-126	-277	- 78	-172
Tires & rims, 17.5-25, 12 PR (L-3)	+ 12	+ 26	+ 7	+ 15
Tires & rims, 17.5-R25, radial (L-3 equivalent)	+ 156	+ 343	+ 96	+ 211
Tires & rims, 17.5-R25, radial (L-2/L-3 equivalent)	+ 95	+ 209	+ 58	+ 128

Bucket Type		Loose Material			Excavating		
		Bolt-on Cutting Edge	Bolt-on Teeth & Segments	Bolt-on Teeth	Bolt-on Cutting Edge	Bolt-on Teeth & Segments	Bolt-on Teeth
Ground Engaging Type							
Rated bucket capacity (\$)	m ³ yd ³	1.70 2.25	1.70 2.25	1.50 2.00	1.50 2.00	1.50 2.00	1.40 1.80
Struck capacity (\$)	m ³ yd ³	1.40 1.80	1.40 1.80	1.30 1.70	1.30 1.70	1.30 1.70	1.20 1.60
Width	mm ft/in	2395 7'10"	2431 7'11"	2431 7'11"	2395 7'10"	2431 7'11"	2431 7'11"
Dump clearance at full lift and 45° discharge (\$)	mm ft/in	2700 8'10"	2592 8'6"	2592 8'6"	2700 8'10"	2592 8'6"	2592 8'6"
Reach at full lift and 45° discharge	mm ft/in	855 2'10"	956 3'2"	956 3'2"	855 2'10"	956 3'2"	956 3'2"
Reach at 45° discharge and 2130 mm (7'0") clearance	mm ft/in	1296 4'3"	1333 4'4"	1333 4'4"	1296 4'3"	1333 4'4"	1333 4'4"
Reach with lift arms horizontal and bucket level	mm ft/in	2049 6'9"	2196 7'2"	2196 7'2"	2049 6'9"	2196 7'2"	2196 7'2"
Digging depth	mm in	93 3.6"	108 4.3"	108 4.3"	93 3.6"	108 4.3"	108 4.3"
Overall length	mm ft/in	6524 21'5"	6670 21'11"	6649 21'8"	6524 21'5"	6670 21'11"	6649 21'8"
Overall height with bucket at full raise	mm ft/in	4682 15'4"	4682 15'4"	4682 15'4"	4557 14'11"	4557 14'11"	4557 14'11"
Loader clearance circle with bucket in carry position	m ft/in	10.70 35'0"	10.82 35'6"	10.82 35'6"	10.67 35'0"	10.79 35'5"	10.79 35'5"
Static tipping load, straight*	kg lb	7203 15,883	7100 15,655	7257 16,002	7203 15,883	7101 15,658	7258 16,004
Static tipping load, full 40° turn*	kg lb	6297 13,885	6194 13,658	6342 13,984	6302 13,896	6200 13,671	6351 14,004
Breakout force	kg lb	9553 21,067	9470 20,881	10 373 22,872	9593 21,153	9512 20,974	10 418 22,972
Operating weight*	kg lb	9025 19,900	9107 20,081	9040 19,933	8988 19,819	9069 19,997	9002 19,849

*Static tipping and operating weights shown include lubricants, full fuel tank, ROPS cab, 257 kg (566 lb) counterweight, 80 kg (176 lb) operator and 17.5 x 25 12 PR (L2) tires. **NOTE:** Specifications and ratings conform to all applicable standards recommended by the Society of Automotive Engineers (SAE). SAE Standards J732 JUN92 and J742 FEB85 govern loader rating, denoted in the text by (\$).

	Change in Operating Weight		Change in Articulated Static Tipping Load	
	kg	lb	kg	lb
15.5-25, 12 PR (L-2) tires & rims	- 62	- 137	- 40	- 88
15.5-25, 12 PR (L-3) tires & rims	- 13	- 29	- 9	- 20
15.5-25, Radial (L-2 equivalent) tires & rims	- 31	- 68	- 20	- 44
15.5-25, Radial (L-3 equivalent) tires & rims	+ 62	+ 137	+ 40	+ 88
17.5-25, 12 PR (L-2) tires & rims	0	0	0	0
17.5-25, Radial (L-2 equivalent) tires & rims	+ 45	+ 99	+ 29	+ 64
17.5-25, Radial (L-3 equivalent) tires & rims	+ 166	+ 366	+ 108	+ 238
17.5-25, Radial (L-2/L-3 equivalent) tires & rims	+ 160	+ 353	+ 103	+ 227
Air conditioner	+ 47	+ 104	+ 50	+ 110
Canopy, ROPS (less cab)	- 210	- 463	- 199	- 439
Counterweight, 257 kg (566 lb) (removal)	- 257	- 567	- 480	- 1059
Counterweight, add second set, 257 kg (566 lb)	+ 257	+ 567	+ 480	+ 1059
Crankcase guard	+ 42	+ 93	+ 66	+ 146
Power train guard	+ 74	+ 163	+ 83	+ 183

Bucket Type		General Purpose						Penetration
		Bolt-On Cutting Edge		Bolt-On Teeth & Segments*		Bolt-On Teeth*		Flush Mounted Teeth*
Rated bucket capacity (\$)	m ³ yd ³	2 2.6	2.2 2.9	2 2.6	2.2 2.9	1.9 2.5	2.1 2.75	2.1 2.75
Struck capacity (\$)	m ³ yd ³	1.7 2.25	1.9 2.5	1.7 2.25	1.9 2.5	1.6 2.1	1.8 2.3	1.8 2.3
Bucket width	mm ft/in	2549 8'4"	2549 8'4"	2549 8'4"	2549 8'4"	2549 8'4"	2549 8'4"	2594 8'6"
Dump clearance at full lift and 45° discharge*** (\$)	mm ft/in	2879 9'5"	2842 9'4"	2766 9'1"	2730 8'11"	2766 9'1"	2729 8'11"	2748 9'0"
Reach at full lift and 45° discharge (\$)	mm ft/in	927 3'0"	964 3'2"	1021 3'4"	1058 3'6"	1021 3'4"	1058 3'6"	1074 3'6"
Reach at 45° discharge and 2130 mm (7'0") clearance (\$)	mm ft/in	1455 4'9"	1474 4'10"	1492 4'11"	1509 4'11"	1492 4'11"	1509 4'11"	1535 5'0"
Reach with arms horizontal and bucket level	mm ft/in	2253 7'5"	2305 7'7"	2399 7'10"	2451 8'0"	2399 7'10"	2451 8'0"	2449 8'0"
Digging depth (\$)	mm in	86 3.4	86 3.4	99 3.9	99 3.9	99 3.9	99 3.9	74 2.9
Overall length	mm ft/in	7255 23'10"	7307 24'0"	7401 24'3"	7453 24'5"	7416 24'4"	7433 24'5"	7432 24'5"
Overall height with bucket at full raise (\$)	mm ft/in	4971 16'4"	5070 16'8"	4971 16'4"	5070 16'8"	4971 16'4"	5070 16'8"	5057 16'7"
Bucket floor angle at full dump and maximum lift		47.5°	47.5°	47.5°	47.5°	47.5°	47.5°	47.5°
Loader clearance circle with bucket in carry position	m ft/in	11.56 38'0"	11.59 38'0"	11.69 38'4"	11.72 38'6"	11.69 38'4"	11.72 38'6"	11.70 38'4"
Static tipping load, straight* (\$)	kg lb	9231 20,354	9074 20,008	9062 19,982	8909 19,644	9150 20,176	9083 20,028	9074 20,008
Static tipping load, full 40° turn* (\$)	kg lb	8020 17,684	7877 17,369	7850 17,309	7709 16,998	7941 17,510	7877 17,369	7868 17,349
Breakout force** (\$)	kg lb	11 723 25,849	11 095 24,464	11 590 25,556	10 961 24,169	12 604 27,792	11 880 26,195	11 947 26,343
Operating weight*	kg lb	11 657 25,704	11 707 25,814	11 791 25,999	11 841 26,109	11 706 25,812	11 756 25,922	11 778 25,970
Shipping weight	kg lb	11 397 25,131	11 447 25,241	11 531 25,426	11 581 25,536	11 446 25,239	11 496 25,349	11 518 25,397

*Static tipping load and operating weight are based on standard machine configuration with 20.5-25, 12 PR (L-2) tires, full fuel tank, coolant, lubricants, operator and optional counterweight.

**Measured 102 mm (4") behind tip of cutting edge with bucket hinge pin as pivot point in accordance with SAE J732 JUN92.

***Dump clearance, reach and overall length dimensions for buckets equipped with teeth reflect actual dimensions. SAE J732 JUN92 allows dimensions for buckets with teeth to reflect the dimension using the cutting edge. Caterpillar Inc. uses actual equipped bucket dimensions.

NOTE: Specifications and ratings conform to all applicable standards recommended by the Society of Automotive Engineers. SAE Standards J732 JUN92 and J742 FEB85 govern loader ratings, denoted in the text by (\$).

	Change in Operating Weight		Change in Articulated Static Tipping Load	
	kg	lb	kg	lb
Air conditioner	+ 48	+106	+ 56	+123
Canopy, ROPS (less cab)	-198	-437	-182	-401
Counterweight, 250 kg/550 lb (removal)	-252	-556	-421	-928
Guard, crankcase	+ 17	+ 37	+ 24	+ 53
Guard, power train	+ 58	+128	+ 56	+123
Ride control	+ 41	+ 90	+ 20	+ 44
Secondary steering	+ 42	+ 93	+ 57	+126
Tires & 1-piece rims, 17.5-25, 12PR (L-2)	-421	-928	-262	-578
Tires & 1-piece rims, 17.5-25, 12PR (L-3)	-342	-354	-213	-470
Tires & 1-piece rims, 17.5-25, 12PR (L-2/L-3)	-279	-615	-174	-384
Tires & 1-piece rims, 17.5-R25, radial (L-2)	-374	-825	-232	-512
Tires & 1-piece rims, 17.5-R25, radial (L-3)	-218	-481	-136	-300
Tires & 3-piece rims, 17.5-25, 12PR (L-2)	-289	-367	-180	-370
Tires & 3-piece rims, 17.5-25, 12PR (L-3)	-217	-478	-147	-324
Tires & 3-piece rims, 17.5-25, 12PR (L-2/L-3)	-173	-381	-108	-238
Tires & 3-piece rims, 17.5-R25, radial (L-2)	-249	-549	-155	-342
Tires & 3-piece rims, 17.5-R25, radial (L-3)	-149	-329	- 93	-205
Tires & 3-piece rims, 20.5-25, 12PR (L-3)	+204	+450	+126	+278
Tires & 3-piece rims, 20.5-25, 12PR (L-2/L-3)	+188	+415	+122	+269
Tires & 3-piece rims, 20.5-R25, radial (L-2)	+ 68	+150	+ 42	+ 93
Tires & 3-piece rims, 20.5-R25, radial (L-3)	+240	+529	+148	+326

Bucket Type	General Purpose						High Lift Arrangement****
	Bolt-on Edges	Bolt-on Adapters & Segments	Bolt-on Adapters	Bolt-on Edges	Bolt-on Adapters & Segments		
Ground Engaging Type							
Rated bucket capacity	m ³ yd ³	2.8 3.65		2.6 3.40	2.5 3.25		Same Same
Struck capacity	m ³ yd ³	2.37 3.10	2.37 3.10	2.27 2.99	2.09 2.74	2.09 2.74	Same Same
Width	mm ft/in	2740 9'0"	2740 9'0"	2706 8'10.5"	2740 9'0"	2740 9'0"	Same Same
Dump clearance at full lift and 45° discharge**	mm ft/in	2786 9'1.5"	2679 8'9.5"	2679 8'9.5"	2846 9'4"	2739 9'0"	+426.4 +14.5"
Reach at full lift and 45° discharge**	mm ft/in	1060 3'6"	1162 3'10"	1162 3'10"	1004 3'3.5"	1106 3'7.5"	+67.7 +2.7"
Reach with lift arms horizontal and bucket level	mm ft/in	2315 7'7"	2462 8'1"	2462 8'1"	2235 7'4"	2382 7'10"	+374.5 +14.9"
Digging depth	mm in	48 1.9"	48 1.9"	23 0.09"	48 1.90"	48 1.90"	+61.3 +2.4"
Overall length**	mm ft/in	7315 24'0"	7419 24'4"	7419 24'4"	7281 23'9"	7389 24'3"	+472.3 +18.6"
Overall height with bucket at full raise	mm ft/in	5185 17'0"	5185 17'0"	5185 17'0"	5084 16'8"	5084 16'8"	+363.7 +14.3"
Loader clearance circle with bucket in carry position	m ft/in	11.98 39'3.5"	12.10 39'8.5"	12.10 39'8.5"	11.92 39'1"	12.04 39'6"	+430.0 +16.9"
Static tipping load, straight*	kg lb	10 572 23,307	10 474 23,091	10 659 23,499	10 707 23,604	10 608 23,386	-1373 -3027
Static tipping load, full 40° turn*	kg lb	9241 20,373	9143 20,157	9317 20,540	9371 20,659	9272 20,441	-1241 -2736
Breakout force***	kg lb	11 376 25,078	11 376 25,078	12 314 27,146	12 328 27,179	12 328 27,179	-558 -1230
Operating weight*	kg lb	13 154 28,999	13 234 29,175	13 151 28,992	13 062 28,796	13 142 28,973	+162 +356

*Static tipping load and operating weight shown are based on standard machine configuration with sound-suppression cab and ROPS, 20.5-R25 XTLA (L-2) tires, full fuel tank, coolant, lubricants and operator.

**Dump clearance, reach and overall length dimensions for bucket equipped with teeth reflect actual dimensions. SAE J732 JUN92 allows dimensions for bucket with teeth to reflect the dimension using the cutting edge. Caterpillar Inc. uses actual equipped bucket dimensions.

***Measured 102 mm (4") behind tip of cutting edge with bucket hinge pin as pivot point in accordance with SAE J732 JUN92.

****All buckets shown can be used on the high lift arrangement. High lift column shows changes in specifications from standard lift to high lift. Add or subtract as indicated to or from specifications given for appropriate bucket to calculate high lift specifications.

	Change in Operating Weight		Change in Articulated Static Tipping Load	
	kg	lb	kg	lb
Remove cab only, ROPS	-198	-437	-191	-421
20.5-25, 12 PR (L-2)	- 60	-132	- 39	- 86
20.5-25, 12 PR (L-3)	+ 85	+187	+ 56	+123
20.5-R25, XTLA (L-2)	—	—	—	—
20.5-R25, GP-2B (L-2/L-3)	+130	+287	+ 86	+190
20.5-R25, XHA (L-3)	+172	+379	+114	+251

Bucket Type	General Purpose					Penetration	High Lift Arrangement****
		Bolt-on Edges	Bolt-on Adapters & Segments	Bolt-on Adapters	Bolt-on Adapters	Flush-mounted Teeth	
Ground Engaging Type							
Rated bucket capacity	m ³ yd ³	2.3 3.00			2.1 2.75	2.1 2.75	Same Same
Struck capacity	m ³ yd ³	1.93 2.52	1.93 2.52	1.99 2.60	1.83 2.40	1.81 2.37	Same Same
Width	mm ft/in	2740 9'0"	2740 9'0"	2706 8'10.5"	2706 8'10.5"	2773 9'1"	Same Same
Dump clearance at full lift and 45° discharge**	mm ft/in	2846 9'4"	2739 9'0"	2739 9'0"	2739 9'0"	2763 9'1"	+426.4 +14.5"
Reach at full lift and 45° discharge**	mm ft/in	1004 3'3.5"	1106 3'7.5"	1106 3'7.5"	1106 3'7.5"	1192 3'11"	+67.7 +2.7"
Reach with lift arms horizontal and bucket level	mm ft/in	2235 7'4"	2382 7'10"	2382 7'10"	2382 7'10"	2379 7'10"	+374.5 +14.7"
Digging depth	mm in	48 1.90"	48 1.90"	23 0.90"	23 0.90"	23 0.90"	+61.3 +2.4"
Overall length**	mm ft/in	7231 23'9"	7389 24'3"	7389 24'3"	7389 24'3"	7414 24'4"	+472.3 +18.6"
Overall height with bucket at full raise	mm ft/in	4993 16'5"	4993 16'5"	5084 16'8"	4993 16'5"	4949 16'3"	+363.7 +14.3"
Loader clearance circle with bucket in carry position	m ft/in	11.02 39'1"	12.04 39'6"	12.04 39'6"	12.04 39'6"	12.06 39'7"	+430.0 +16.9"
Static tipping load, straight*	kg lb	10 639 23,455	10 580 23,326	10 795 23,798	10 766 23,734	10 668 23,518	-1373 -3027
Static tipping load, full 40° turn*	kg lb	9347 20,606	9248 20,388	9448 20,829	9422 20,772	9332 20,573	-1241 -2736
Breakout force***	kg lb	12 328 27,179	12 328 27,179	13 291 29,301	13 291 29,301	13 291 29,301	-558 -1230
Operating weight*	kg lb	13 064 28,800	13 144 28,977	13 059 28,790	13 061 28,794	13 104 28,889	+162 +356

*Static tipping load and operating weight shown are based on standard machine configuration with sound-suppression cab and ROPS, 20.5-R25 XTLA (L-2) tires, full fuel tank, coolant, lubricants and operator.

**Dump clearance, reach and overall length dimensions for bucket equipped with teeth reflect actual dimensions. SAE J732 JUN92 allows dimensions for bucket with teeth to reflect the dimension using the cutting edge. Caterpillar Inc. uses actual equipped bucket dimensions.

***Measured 102 mm (4") behind tip of cutting edge with bucket hinge pin as pivot point in accordance with SAE J732 JUN92.

****All buckets shown can be used on the high lift arrangement. High lift column shows changes in specifications from standard lift to high lift. Add or subtract as indicated to or from specifications given for appropriate bucket to calculate high lift specifications.

	Change in Operating Weight		Change in Articulated Static Tipping Load	
	kg	lb	kg	lb
Remove cab only, ROPS	-198	-437	-191	-421
20.5-25, 12 PR (L-2)	- 60	-132	- 39	- 86
20.5-25, 12 PR (L-3)	+ 85	+187	+ 56	+123
20.5-R25, XTLA (L-2)	—	—	—	—
20.5-R25, GP-2B (L-2/L-3)	+130	+287	+ 86	+190
20.5-R25, XHA (L-3)	+172	+379	+114	+251

Bucket Type	General Purpose									High Lift†	
	Ground Engaging Type	Bolt-on Edges	Teeth & Segments*	Teeth*	Bolt-on Edges	Teeth & Segments*	Teeth*	Bolt-on Edges	Teeth & Segments*		Teeth*
Rated capacity (\$)	m³ yd³	3.1 4	3.1 4	2.9 3.75	2.9 3.75	2.9 3.75	2.7 3.5	2.7 3.5	2.7 3.5	2.5 3.25	Same Same
Struck capacity (\$)	m³ yd³	2.66 3.46	2.66 3.46	2.50 3.25	2.46 3.2	2.46 3.2	2.31 3	2.27 2.95	2.27 2.95	2.12 2.76	Same Same
Width (\$)	mm ft/in	2843 9'3.9"	2927 9'7.2"	2927 9'7.2"	2843 9'3.9"	2927 9'7.2"	2927 9'7.2"	2843 9'3.9"	2927 9'7.2"	2927 9'7.2"	Same Same
Dump clearance at full lift and 45° discharge (\$)	mm ft/in	2852.1 9'4.3"	2748.7 9'0.2"	2748.7 9'0.2"	2898.4 9'6.1"	2795.8 9'2.1"	2795.8 9'2.1"	2945.7 9'8"	2844.2 9'4"	2844.2 9'4"	+558 +1'10"
Reach at full lift and 45° discharge (\$)	mm ft/in	1286.6 4'2.7"	1384.6 4'6.5"	1384.6 4'6.5"	1250.8 4'1.3"	1349.7 4'5.1"	1349.7 4'5.1"	1216.7 3'11.9"	1316.7 4'3.9"	1316.7 4'3.9"	+25 +1.0"
Reach with lift arms horizontal and bucket level	mm ft/in	2597.2 8'6.3"	2739 8'11.8"	2739 8'11.8"	2537.2 8'3.9"	2679 8'9.5"	2679 8'9.5"	2477.2 8'1.5"	2619 8'7.1"	2619 8'7.1"	+425 +16.7"
Digging depth (\$)	mm in	101 3.97	101 3.97	101 3.97	101 3.97	101 3.97	101 3.97	101 3.97	101 3.97	101 3.97	+25 +1.0"
Overall length (\$)	mm ft/in	8048.2 26'4.9"	8190 26'10.4"	8190 26'10.4"	7988.2 26'2.5"	8130 26'8.1"	8130 26'8.1"	7928.2 26'0.1"	8070 26'5.7"	8070 26'5.7"	+525 +1'8.7"
Overall height with bucket at full raise (\$)	mm ft/in	5256.5 17'2.9"	5256.5 17'2.9"	5256.5 17'2.9"	5198.1 17'0.6"	5198.1 17'0.6"	5198.1 17'0.6"	5140.3 16'10.4"	5140.3 16'10.4"	5140.3 16'10.4"	+558 +1'10"
Loader clearance circle with bucket in carry position (\$)	m ft	13.29 43'7"	13.43 44'1"	13.43 44'1"	13.25 43'6"	13.39 43'11"	13.97 45'10"	13.22 43'4"	13.36 43'10"	13.36 43'10"	+237 +9.3"
Static tipping load, straight** (\$)	kg lb	11 850 26,117	11 741 25,877	12 047 26,552	11 965 26,371	11 856 26,131	12 166 26,814	12 082 26,629	11 974 26,391	12 287 27,081	-850 -1874
Static tipping load, full 40° turn** (\$)	kg lb	10 410 22,944	10 301 22,703	10 591 23,343	10 518 23,182	10 410 22,944	10 703 23,589	10 629 23,426	10 521 23,188	10 817 23,841	-935 -2062
Breakout force*** (\$)	kN lb	146.3 32,809.2	145.8 32,697.1	146.6 32,876.5	154.5 34,648.2	154 34,536	154.8 34,715.4	163.1 36,576	162.7 36,487.1	163.4 36,644.1	-878 -1935
Operating weight** (\$)	kg lb	17 428 38,411	17 523 38,621	17 358 38,257	17 376 38,297	17 471 38,506	17 306 38,142	17 322 38,178	17 417 38,387	17 252 38,023	+210 +463

*Dimensions are measured to the tip of the bucket teeth to provide accurate clearance data. SAE Standards specifies the cutting edge.

**Static tipping load and operating weight shown include standard machine with 23.5-R25, XHA (L-3) tires, full fuel tank, coolant, lubricants, operator, air conditioning, crumple and power train guards.

***Measured 102 mm (4") behind tip of cutting edge with bucket hinge pin as pivot point in accordance with SAE J732 JUN92.

†All buckets shown can be used on high lift arrangement. High lift column shows changes in specifications from standard lift to high lift. Add or subtract as indicated to or from specifications given for appropriate bucket to calculate high lift specifications.

NOTE: Specifications and ratings conform to all applicable standards recommended by the Society of Automotive Engineers. SAE Standards J732 JUN92 and J742 FEB85 govern loader ratings and are denoted in the text by (\$).

	Change in Operating Weight		Change in Static Tipping Load — Straight	
	kg	lb	kg	lb
23.5-25, 12 PR (L-2)	-408	-900	-300	-660
23.5-25, 16 PR (L-3)	-300	-660	-221	-487
23.5-R25, XHA (L-2) standard	—	—	—	—
23.5-R25, XTLA (L-2) steel radial	-100	-220	- 63	-139
23.5-R25, GP-2B (L-2/3) steel radial	- 76	-168	- 60	-132

Bucket Type	Material Handling						Rock		High Lift†	
		Bolt-on Edges	Teeth & Segments*	Teeth*	Bolt-on Edges	Teeth & Segments*	Teeth*	Bolt-on Edges	Bottom Strap Teeth	All Stand. Buckets Available
Ground Engaging Type										
Rated capacity (\$)	m³ yd³	3.3 4.25	3.3 4.25	3.1 4	3.1 4	3.1 4	2.9 3.75	2.7 3.5	2.7 3.5	Same Same
Struck capacity (\$)	m³ yd³	2.83 3.68	2.83 3.68	2.66 3.46	2.66 3.46	2.66 3.46	2.51 3.26	2.38 3.09	2.37 3.08	Same Same
Width (\$)	mm ft/in	2843 9'3.9"	2927 9'7.2"	2927 9'7.2"	2843 9'3.9"	2927 9'7.2"	2927 9'7.2"	2984 9'9.4"	2969 9'8.9"	Same Same
Dump clearance at full lift and 45° discharge (\$)	mm ft/in	2808.2 9'2.6"	2698.3 8'10.2"	2698.3 8'10.2"	2843.6 9'3.9"	2775.6 9'1.2"	2733.6 8'11.6"	2862.5 9'4.7"	2807.3 9'2.5"	+558 +1'10"
Reach at full lift and 45° discharge (\$)	mm ft/in	1196 3'11.1"	1286.3 4'2.6"	1286.3 4'2.6"	1160.4 3'9.7"	1250.9 4'1.3"	1250.9 4'1.3"	1316.7 4'3.9"	1353.3 4'5.3"	+25 +1.0"
Reach with lift arms horizontal and bucket level	mm ft/in	2582.2 8'5.7"	2724 8'11.2"	2724 8'11.2"	2532.2 8'3.7"	2674 8'9.3"	2674 8'9.3"	2607.2 8'6.6"	2689 8'9.9"	+425 +16.7"
Digging depth (\$)	mm in	101 3.97	101 3.97	101 3.97	101 3.97	101 3.97	101 3.97	101 3.97	120 4.72	+25 +1.0"
Overall length (\$)	mm ft/in	8033.2 26'4.3"	8175 26'9.9"	8175 26'9.9"	7983.2 26'2.3"	8125 26'7.9"	8125 26'7.9"	8058 26'5.2"	8096 26'6.7"	+525 +1'8.7"
Overall height with bucket at full raise (\$)	mm ft/in	5245.9 17'2.5"	5245.9 17'2.5"	5245.9 17'2.5"	5198.2 17'0.6"	5198.2 17'0.6"	5198.2 17'0.6"	5330.1 17'5.8"	5330.1 17'5.8"	+558 +1'10"
Loader clearance circle with bucket in carry position (\$)	m ft	13.28 43'7"	13.42 44'0"	13.42 44'0"	13.25 43'6"	13.39 43'11"	13.39 43'11"	13.36 43'10"	13.38 43'11"	+237 +9.3"
Static tipping load, straight** (\$)	kg lb	12 073 26,609	11 963 26,366	12 276 27,056	12 175 26,834	12 065 26,591	12 381 27,288	11 827 26,067	11 964 26,369	-850 -1874
Static tipping load, full 40° turn** (\$)	kg lb	10 614 23,393	10 504 23,151	10 800 23,803	10 710 23,605	10 600 23,362	10 899 24,021	10 361 22,836	10 493 23,127	-935 -2062
Breakout force*** (\$)	kN lb	148.1 33,212.9	147.6 33,100.8	148.4 33,280.2	155.3 34,827.6	154.8 34,715.4	155.6 34,894.9	141.3 31,687.9	149.3 33,482	-878 -1935
Operating weight** (\$)	kg lb	17 357 38,255	17 452 38,464	17 287 38,101	17 316 38,164	17 411 38,374	17 246 38,010	17 656 38,914	17 573 38,731	+210 +463

*Dimensions are measured to the tip of the bucket teeth to provide accurate clearance data. SAE Standards specifies the cutting edge.

**Static tipping load and operating weight shown include standard machine with 23.5-R25, XHA (L-3) tires, full fuel tank, coolant, lubricants, operator, air conditioning, crumple and power train guards.

***Measured 102 mm (4") behind tip of cutting edge with bucket hinge pin as pivot point in accordance with SAE J732 JUN92.

†All buckets shown can be used on high lift arrangement. High lift column shows changes in specifications from standard lift to high lift. Add or subtract as indicated to or from specifications given for appropriate bucket to calculate high lift specifications.

NOTE: Specifications and ratings conform to all applicable standards recommended by the Society of Automotive Engineers. SAE Standards J732 JUN92 and J742 FEB85 govern loader ratings and are denoted in the text by (\$).

	Change in Operating Weight		Change in Static Tipping Load — Straight	
	kg	lb	kg	lb
23.5-25, 12 PR (L-2)	-408	-900	-300	-660
23.5-25, 16 PR (L-3)	-300	-660	-221	-487
23.5-R25, XHA (L-2) standard	—	—	—	—
23.5-R25, XTLA (L-2) steel radial	-100	-220	- 63	-139
23.5-R25, GP-2B (L-2/3) steel radial	- 76	-168	- 60	-132

Bucket Type	General Purpose						Material Handling			
		Bolt-on Edges	Teeth & Segments*	Teeth*	Bolt-on Edges	Teeth & Segments*	Teeth*	Bolt-on Edges	Teeth & Segments*	Teeth*
Ground Engaging Type										
Rated capacity (\$)	m ³ yd ³	3.3 4.25	3.3 4.25	3.1 4	3.1 4	3.1 4	2.9 3.75	3.8 5	3.8 5	3.6 4.75
Struck capacity (\$)	m ³ yd ³	2.83 3.68	2.83 3.68	2.66 3.46	2.66 3.46	2.66 3.46	2.50 3.25	3.26 4.24	3.26 4.24	3.10 4
Width (\$)	mm ft/in	2927 9'7.2"	2994 9'9.9"	2994 9'9.9"	2927 9'7.2"	2994 9'9.9"	2994 9'9.9"	2927 9'7.2"	2994 9'9.9"	2994 9'9.9"
Dump clearance at full lift and 45° discharge (\$)	mm ft/in	3029.8 9'11.3"	2926.2 9'7.2"	2962.2 9'7.2"	3065 10'0.7"	2961.8 9'8.6"	2961.8 9'8.6"	2915.8 9'6.8"	2805.9 9'2.5"	2805.9 9'2.5"
Reach at full lift and 45° discharge (\$)	mm ft/in	1252.7 4'1.3"	1350.4 4'5.2"	1350.4 4'5.2"	1218.4 4'0"	1316.5 4'3.8"	1316.5 4'3.8"	1324.6 4'4.1"	1324.6 4'4.1"	1324.6 4'4.1"
Reach with lift arms horizontal and bucket level	mm ft/in	2722.6 8'11.2"	2864.4 9'4.8"	2864.4 9'4.8"	2672.6 8'9.2"	2814.4 9'2.8"	2814.4 9'2.8"	2949.4 9'8.1"	2949.4 9'8.1"	2949.4 9'8.1"
Digging depth (\$)	mm in	97.6 3.8	97.6 3.8	97.6 3.8	97.6 3.8	97.6 3.8	97.6 3.8	97.6 3.8	97.6 3.8	97.6 3.8
Overall length (\$)	mm ft/in	8200.7 26'10.9"	8342.5 27'4.4"	8342.5 27'4.4"	8150.7 26'8.9"	8292.5 27'2.5"	8292.5 27'2.5"	8285.7 27'2.5"	8427.5 27'7.8"	8427.5 27'7.8"
Overall height with bucket at full raise (\$)	mm ft/in	5479.3 17'11.7"	5479.3 17'11.7"	5479.3 17'11.7"	5454.9 17'10.8"	5454.9 17'10.8"	5454.9 17'10.8"	5563.6 18'3"	5563.6 18'3"	5563.6 18'3"
Loader clearance circle with bucket in carry position (\$)	m ft	13.47 44'2"	13.59 44'7"	13.59 44'7"	13.44 44'1"	13.56 44'6"	13.56 44'6"	13.51 44'4"	13.63 44'9"	13.63 44'9"
Static tipping load, straight** (\$)	kg lb	12 515 27,583	12 484 27,515	12 712 28,017	12 627 27,830	12 518 27,590	12 828 28,273	12 595 27,759	12 484 27,515	12 788 28,185
Static tipping load, full 40° turn** (\$)	kg lb	10 913 24,052	10 881 23,982	11 093 24,449	11 019 24,286	10 910 24,046	11 202 24,689	10 983 24,207	10 872 23,962	11 160 24,597
Breakout force*** (\$)	kN lb	140.7 31,553.5	140.2 31,441.4	141 31,620.8	147.1 32,988.8	146.7 32,899.1	147.5 33,078.5	133.8 30,006.1	133.3 29,894	134.2 30,095.8
Operating weight** (\$)	kg lb	18 324 40,386	18 419 40,595	18 254 40,232	18 259 40,243	18 354 40,452	18 189 40,089	18 295 40,322	18 390 40,532	18 225 40,168

*Dimensions are measured to the tip of the bucket teeth to provide accurate clearance data. SAE Standards specifies the cutting edge.

**Static tipping load and operating weight shown include standard machine with 23.5-R25, XHA (L-3) tires, air conditioning, crankcase guard, power train guard, full fuel tank, coolant, lubricants and operator.

***Measured 102 mm (4") behind tip of cutting edge with bucket hinge pin as pivot point in accordance with SAE J732 JUN92.

NOTE: Specifications and ratings conform to all applicable standards recommended by the Society of Automotive Engineers. SAE Standards J732 JUN92 and J742 FEB85 govern loader ratings and are denoted in the text by (\$).

	Change in Operating Weight		Change in Static Tipping Load — Straight	
	kg	lb	kg	lb
23.5-25, 12 PR (L-2)	-408	-900	-300	-660
23.5-25, 16 PR (L-3)	-300	-660	-221	-487
23.5-R25, XHA (L-2) standard	—	—	—	—
23.5-R25, XTLA (L-2) steel radial	-100	-220	- 63	-139
23.5-R25, GP-2B (L-2/3) steel radial	- 76	-168	- 60	-132

Bucket Type	Material Handling						Rock		
	Ground Engaging Type	Bolt-on Edges	Teeth & Segments*	Teeth*	Bolt-on Edges	Teeth & Segments*	Teeth*	Bolt-on Edges	Bottom Strap Teeth
Rated capacity (\$)	m ³ yd ³	3.5 4.5	3.5 4.5	3.3 4.25	3.3 4.25	3.3 4.25	3.1 4	3.1 4	3.1 4
Struck capacity (\$)	m ³ yd ³	3.00 3.9	3.00 3.9	2.83 3.68	2.83 3.68	2.83 3.68	2.67 3.47	2.72 3.53	2.72 3.53
Width (\$)	mm ft/in	2927 9'7.2"	2994 9'9.9"	2994 9'9.9"	2927 9'7.2"	2994 9'9.9"	2994 9'9.9"	2984 9'9.5"	2969 9'8.9"
Dump clearance at full lift and 45° discharge (\$)	mm ft/in	2968.9 9'8.9"	2858.9 9'4.6"	2858.9 9'4.6"	3004.5 9'10.3"	2894.5 9'6"	2894.5 9'6"	2994.5 9'9.9"	2938.8 9'7.7"
Reach at full lift and 45° discharge (\$)	mm ft/in	1271.6 4'2.1"	1271.6 4'2.1"	1271.6 4'2.1"	1236.6 4'0.7"	1236.6 4'0.7"	1236.6 4'0.7"	1311.6 4'3.6"	1347.2 4'5"
Reach with lift arms horizontal and bucket level	mm ft/in	2874.4 9'10.7"	3016.2 9'10.7"	3016.2 9'10.7"	2824.4 9'8.8"	2966.2 9'8.8"	2966.2 9'8.8"	2787.6 9'1.7"	2869.4 9'5"
Digging depth (\$)	mm in	97.6 3.8	97.6 3.8	97.6 3.8	97.6 3.8	97.6 3.8	97.6 3.8	97.6 3.8	116.54 4.6
Overall length (\$)	mm ft/in	8210.7 27'4.8"	8352.5 27'4.8"	8352.5 27'4.8"	8160.7 26'9.3"	8302.5 27'2.9"	8302.5 27'2.9"	8265.7 27'1.4"	8305.6 27'3"
Overall height with bucket at full raise (\$)	mm ft/in	5492 18'0.2"	5492 18'0.2"	5492 18'0.2"	5444.4 17'10.3"	5444.4 17'10.3"	5444.4 17'10.3"	5608.8 18'4.8"	5608.8 18'4.8"
Loader clearance circle with bucket in carry position (\$)	m ft	13.46 44'2"	13.58 44'7"	13.58 44'7"	13.43 44'1"	13.55 44'5"	13.55 44'5"	13.54 44'5"	13.65 44'9"
Static tipping load, straight** (\$)	kg lb	12 749 28,099	12 639 27,856	12 952 28,546	12 853 28,328	12 744 28,088	13 060 28,784	12 161 26,803	12 312 27,136
Static tipping load, full 40° turn** (\$)	kg lb	11 127 24,524	11 017 24,281	11 313 24,934	11 224 24,738	11 115 24,497	11 413 25,154	10 534 23,217	10 681 23,541
Breakout force*** (\$)	kN lb	142.5 31,957.2	142 31,845.1	142.8 32,024.5	148.9 33,392.5	148.5 33,302.8	149.2 33,459.7	131.6 29,512.7	137.8 30,903.2
Operating weight** (\$)	kg lb	18 230 40,179	18 325 40,388	18 160 40,025	18 188 40,086	18 283 40,296	18 118 39,932	18 843 41,530	18 760 41,347

*Dimensions are measured to the tip of the bucket teeth to provide accurate clearance data. SAE Standards specifies the cutting edge.

**Static tipping load and operating weight shown include standard machine with 23.5-R25, XHA (L-3) tires, air conditioning, crankcase guard, power train guard, full fuel tank, coolant, lubricants and operator.

***Measured 102 mm (4") behind tip of cutting edge with bucket hinge pin as pivot point in accordance with SAE J732 JUN92.

NOTE: Specifications and ratings conform to all applicable standards recommended by the Society of Automotive Engineers. SAE Standards J732 JUN92 and J742 FEB85 govern loader ratings and are denoted in the text by (\$).

	Change in Operating Weight		Change in Static Tipping Load — Straight	
	kg	lb	kg	lb
23.5-25, 12 PR (L-2)	-408	-900	-300	-660
23.5-25, 16 PR (L-3)	-300	-660	-221	-487
23.5-R25, XHA (L-2) standard	—	—	—	—
23.5-R25, XTLA (L-2) steel radial	-100	-220	- 63	-139
23.5-R25, GP-2B (L-2/3) steel radial	- 76	-168	- 60	-132

Bucket Type	General Purpose						Penetration	High Lift*
	Bolt-on Edges	Teeth & Segments	Teeth	Bolt-on Edges	Teeth & Segments	Teeth		
Ground Engaging Tools								All Stand. Buckets Available
Capacity, rated (§)	m³ yd³	3.8 5	3.8 5	3.6 4.75	3.6 4.75	3.6 4.75	3.6 4.75	Same Same
Capacity, struck (§)	m³ yd³	3.25 4.26	3.25 4.26	3.04 3.95	3.18 4.17	3.18 4.17	3.12 4.09	Same Same
Width (§)	mm ft/in	3059 10'0"	3107 10'2"	3107 10'2"	3059 10'0"	3107 10'2"	3128 10'3"	Same Same
Dump clearance at full lift and 45° discharge (§)	mm ft/in	2987 9'9"	2851 9'4"	2851 9'4"	2987 9'9"	2851 9'4"	2775 9'1"	+606 +1'11.6"
Reach at full lift and 45° discharge	mm ft/in	1277 4'2"	1400 4'7"	1400 4'7"	1277 4'2"	1400 4'7"	1320 4'4"	+37 +1.5"
Reach at 45° discharge and 2130 mm (7'0") clearance (§)	mm ft/in	1834 6'0"	1894 6'2"	1894 6'2"	1834 6'0"	1894 6'2"	1776 5'10"	+497 +1'7.6"
Reach with lift arm horizontal and bucket level	mm ft/in	2585 8'6"	2766 9'1"	2766 9'1"	2585 8'6"	2766 9'1"	2788 9'2"	+465 +18.3"
Digging depth (§)	mm in	76 3"	76 3"	46 1.8"	76 3"	76 3"	46 1.8"	Same Same
Overall length (§)	mm ft/in	8303 27'3"	8506 27'11"	8506 27'11"	8213 26'11"	8506 27'11"	8491 27'10"	+576 +1'10.7"
Overall height with bucket at full raise (§)	mm ft/in	5595 18'4"	5595 18'4"	5595 18'4"	5595 18'4"	5595 18'4"	5595 18'4"	+600 +1'11.8"
Loader clearance circle with bucket in carry position (§)	mm ft/in	14 722 48'4"	14 876 48'10"	14 876 48'10"	14 722 48'4"	14 876 48'10"	14 880 48'10"	+251 +9.9"
Static tipping load, straight**	kg lb	14 539 32,044	14 781 32,577	14 684 32,364	14 503 31,965	14 369 31,669	14 593 32,163	-468 -1030
Static tipping load, full 40° turn**	kg lb	13 230 29,172	13 433 29,620	13 363 29,465	13 184 29,093	13 060 28,797	13 274 29,269	-554 -1220
Breakout force*** (§)	kN lb	201 45,187	200.2 45,007	215.5 48,446	201.1 45,209	201 45,187	215.1 48,356	-24.5 -5511
Operating weight** (§)	kg lb	21 293 46,951	21 466 47,333	21 312 46,993	21 286 46,936	21 459 47,317	21 371 47,123	+1202 +2645

*All buckets shown can be used on high lift arrangement. High lift column shows changes in specifications from standard lift to high lift. Add or subtract as indicated to or from specifications given for appropriate bucket to calculate high lift specifications.

**Static tipping load and operating weight shown include sound-suppressed cab and ROPS, 26.5-25 tires, full fuel tank, coolant, lubricants and operator.

***Measured 102 mm (4") behind tip of cutting edge with bucket hinge pin as pivot point in accordance with SAE J732 JUN92.

NOTE: Specifications and ratings conform to all applicable standards recommended by the Society of Automotive Engineers. SAE Standards J732 JUN92 and J742 FEB85 govern loader ratings and are denoted in the text by (§).

	Change in Operating Weight		Change in Articulated Static Tipping Load	
	kg	lb	kg	lb
Remove cab only, ROPS remains	-177	- 390	- 150	- 331
26.5-25, 20 PR (L-3)	-211	- 465	- 142	- 313
26.5-R25, GP-2B, (L-2/3) radial	- 35	- 77	- 24	- 53
26.5-25, 14 PR (L-2)	-561	-1237	- 376	- 829
23.5-25, 16 PR (L-2)	-980	-2161	- 657	-1449
23.5-25, 16 PR (L-3)	-818	-1804	- 548	-1208
23.5-25, 24 PR (L-3)	-691	-1524	- 464	-1023
23.5-R25, GP-2B (L-2/3) radial	-664	-1464	- 445	- 981
23.5-R25, XHA (L-3) radial	-580	-1279	- 389	- 858
Tire ballast: 23.5-25 bias ply tires	+191	+ 421	+ 631	+1391
Tire ballast: 26.5-25 bias ply tires	+995	+2105	+1656	+3652

Bucket Type	General Purpose				Rock		High Lift*	
	With Teeth	Bolt-on Edges	Teeth & Segments	Teeth	No Teeth	Bottom Strap Teeth		
Ground Engaging Tools							All Stand. Buckets Available	
Capacity, rated (\$)	m ³ yd ³	3.5 4.5	3.5 4.5	3.5 4.5	3.3 4.25	3.5 4.5	3.5 4.5	Same Same
Capacity, struck (\$)	m ³ yd ³	2.76 3.59	2.91 3.81	2.91 3.81	2.76 3.62	2.94 4.51	2.94 4.51	Same Same
Width (\$)	mm ft/in	3107 10'2"	3059 10'0"	3107 10'2"	3107 10'2"	3085 10'1"	3085 10'1"	Same Same
Dump clearance at full lift and 45° discharge (\$)	mm ft/in	2851 9'4"	3061 10'0"	2927 9'7"	2927 9'7"	3022 9'11"	2807 9'2"	+600 +1'11.6"
Reach at full lift and 45° discharge	mm ft/in	1400 4'7"	1229 4'0"	1354 4'5"	1354 4'5"	1360 4'5"	1525 5'0"	+37 +1.5"
Reach at 45° discharge and 2130 mm (7'0") clearance (\$)	mm ft/in	1894 6'2"	1816 5'11"	1885 6'2"	1885 6'2"	1932 6'4"	1997 6'6"	+497 +1'7.6"
Reach with lift arm horizontal and bucket level	mm ft/in	2766 9'1"	2495 8'2"	2676 8'9"	2676 8'9"	2618 8'7"	2879 9'5"	+465 +18.3"
Digging depth (\$)	mm in	46 1.8"	76 3"	76 3"	46 1.8"	46 1.8"	46 1.8"	Same Same
Overall length (\$)	mm ft/in	8506 27'11"	8213 26'11"	8416 27'7"	8416 27'7"	8311 27'3"	8630 28'4"	+576 +1'10.7"
Overall height with bucket at full raise (\$)	mm ft/in	5595 18'4"	5521 18'1"	5521 18'1"	5521 18'1"	5616 18'5"	5616 18'5"	+600 +1'11.8"
Loader clearance circle with bucket in carry position (\$)	mm ft/in	14 876 48'10"	14 674 48'2"	14 828 48'8"	14 828 48'8"	14 748 48'5"	14 926 49'0"	+251 +9.9"
Static tipping load, straight**	kg lb	14 702 32,403	14 658 32,306	14 465 31,881	14 842 32,712	14 786 32,588	14 712 32,425	-468 -1030
Static tipping load, full 40° turn**	kg lb	13 381 29,505	13 342 29,419	13 148 28,981	13 513 29,796	13 456 29,670	13 381 29,505	-554 -1220
Breakout force*** (\$)	kN lb	215.9 48,536	216.6 48,693	214.9 48,311	233.6 52,515	196.1 44,123	197 44,287	-24.5 -5513
Operating weight** (\$)	kg lb	21 305 46,778	21 233 46,819	21 406 47,200	21 252 46,861	21 329 47,030	21 395 47,176	+1202 +2645

*All buckets shown can be used on high lift arrangement. High lift column shows changes in specifications from standard lift to high lift. Add or subtract as indicated to or from specifications given for appropriate bucket to calculate high lift specifications.

**Static tipping load and operating weight shown include sound-suppressed cab and ROPS, 26.5-25 tires, full fuel tank, coolant, lubricants and operator.

***Measured 102 mm (4") behind tip of cutting edge with bucket hinge pin as pivot point in accordance with SAE J732 JUN92.

NOTE: Specifications and ratings conform to all applicable standards recommended by the Society of Automotive Engineers. SAE Standards J732 JUN92 and J742 FEB85 govern loader ratings and are denoted in the text by (\$).

Remove cab only, ROPS remains	
26.5-25, 20 PR (L-3)	
26.5-R25, GP-2B, (L-2/3) radial	
26.5-25, 14 PR (L-2)	
23.5-25, 16 PR (L-2)	
23.5-25, 16 PR (L-3)	
23.5-25, 24 PR (L-3)	
23.5-R25, GP-2B (L-2/3) radial	
23.5-R25, XHA (L-3) radial	
Tire ballast: 23.5-25 bias ply tires	
Tire ballast: 26.5-25 bias ply tires	

Change in Operating Weight		Change in Articulated Static Tipping Load	
kg	lb	kg	lb
-177	- 390	- 150	- 331
-211	- 465	- 142	- 313
- 35	- 77	- 24	- 53
-561	-1237	- 376	- 829
-980	-2161	- 657	-1449
-818	-1804	- 548	-1208
-691	-1524	- 464	-1023
-664	-1464	- 445	- 981
-580	-1279	- 389	- 858
+191	+ 421	+ 631	+1391
+995	+2105	+1656	+3652

Bucket Type		Material Handling						General Purpose	
		Bolt-on Edges	Teeth & Segments	Bolt-on Edges	Teeth & Segments	Bolt-on Edges	Teeth & Segments	Bolt-on Edges	Teeth & Segments
Ground Engaging Tools									
Capacity, heaped (S)	m ³ yd ³	4.7 6	4.7 6	4.3 5.6	4.3 5.6	4 5.25	4 5.25	4.3 5.6	4.3 5.6
Struck capacity	m ³ yd ³	3.91 5.11	3.91 5.11	3.67 4.80	3.67 4.80	3.44 4.50	3.44 4.50	3.57 4.67	3.57 4.67
Width	mm ft/in	3220 10'7"	3268 10'9"	3220 10'7"	3220 10'7"	3059 10'0"	3107 10'2"	3220 10'7"	3268 10'9"
Dump clearance at full lift and 45° discharge*	mm ft/in	3225 10'6"	3097 10'1"	3225 10'6"	3097 10'1"	3323 10'10"	3191 10'5"	3323 10'10"	3191 10'5"
Reach at full lift and 45° discharge**	mm ft/in	1357 4'5"	1469 4'10"	1357 4'5"	1469 4'10"	1238 4'1"	1348 4'5"	1147 3'9"	1272 4'2"
Reach at 45° discharge and 2130 mm (7'0") clearance	mm ft/in	1887 6'2"	1926 6'4"	1887 6'2"	1926 6'4"	1834 6'0"	1876 6'2"	1981 6'6"	2047 6'9"
Reach with lift arms horizontal and bucket level	mm ft/in	2864 9'5"	3045 10'0"	2864 9'5"	3045 10'0"	2715 8'11"	2896 9'6"	2715 8'11"	2896 9'6"
Digging depth	mm in	76 3"	76 3"	76 3"	76 3"	76 3"	76 3"	76 3"	76 3"
Overall length**	mm ft/in	8675 28'6"	8856 29'1"	8675 28'6"	8856 29'1"	8526 28'0"	8707 28'7"	8526 28'0"	8707 28'7"
Overall height with bucket at full raise	mm ft/in	5808 19'1"	5808 19'1"	5865 19'3"	5865 19'3"	5893 19'4"	5893 19'4"	5893 19'4"	5893 19'4"
Loader clearance circle with bucket in carry position	mm ft/in	15 012 49'3"	15 120 49'7"	15 012 49'3"	15 120 49'7"	14 782 48'6"	14 936 49'0"	14 930 49'0"	15 084 49'6"
Static tipping load, straight***	kg lb	16 083 35,447	15 910 35,066	16 096 35,476	15 920 35,088	16 674 36,749	16 497 36,359	16 865 37,170	16 487 36,337
Static tipping load, full 35° turn***	kg lb	14 435 31,870	14 279 31,484	14 470 31,906	14 295 31,520	15 026 33,132	14 849 32,741	15 214 33,546	14 836 32,713
Breakout force****	kN lb	161.8 36,405	160.9 36,202	162.1 36,473	161.2 36,270	183.3 41,243	182.4 41,040	183.1 41,175	182.4 40,995
Operating weight***	kg lb	23 693 52,237	23 866 52,625	23 639 52,124	23 812 52,505	23 310 51,399	23 483 51,780	23 328 51,438	23 501 51,820

*Material handling buckets discharge at less than 45° as measured from the inside floor of the bucket at full lift, in accordance with SAE J732 JUN92.

**Reach at 45° discharge is measured at less than full lift for material handling buckets.

***Static tipping load and operating weight shown includes sound-suppressed cab and ROPS, 26.5-25, tires, full fuel tank, coolant, lubricants and operator.

****Measured 102 mm (4") behind tip of cutting edge with bucket hinge pin as pivot point in accordance with SAE J732 JUN92.

	Change in Operating Weight		Change in Articulated Static Tipping Load	
	kg	lb	kg	lb
Remove cab only, ROPS remains	-177	- 390	-150	- 331
26.5-25, 20 PR (L-3)	-211	- 465	-130	- 286
26.5-R25, GP-2B, (L-2/3) radial	- 35	- 77	- 22	- 47
23.5-25, 20 PR (L-3)	-754	-1663	-465	-1025
23.5-R25, GP-2B (L-2/3) radial	-664	-1464	-408	- 900
23.5-R25, XHA (L-3) radial	-580	-1279	-357	- 786

Bucket Type		General Purpose				
		Bolt-on Edges	Teeth & Segments	Bolt-on Edges	Teeth & Segments	Teeth
Ground Engaging Tools						
Rated bucket capacity	m ³	4	4	3.8	3.8	3.8
	yd ³	5.25	5.25	5	5	5
Struck capacity	m ³	3.39	3.39	3.25	3.25	3.23
	yd ³	4.43	4.43	4.25	4.25	4.22
Width	mm	3059	3107	3059	3107	3107
	ft/in	10'0"	10'2"	10'0"	10'2"	10'2"
Dump clearance at full lift and 45° discharge*	mm	3323	3191	3323	3191	3191
	ft/in	10'10"	10'5"	10'10"	10'5"	10'5"
Reach at full lift and 45° discharge**	mm	1147	1272	1147	1272	1272
	ft/in	3'9"	4'2"	3'9"	4'2"	4'2"
Reach at 45° discharge and 2130 mm (7'0") clearance	mm	1981	2047	1981	2047	2047
	ft/in	6'6"	6'9"	6'6"	6'9"	6'9"
Reach with lift arms horizontal and bucket level	mm	2715	2896	2715	2896	2896
	ft/in	8'11"	9'6"	8'11"	9'6"	9'6"
Digging depth	mm	76	76	76	76	46
	in	3"	3"	3"	3"	1.8"
Overall length**	mm	8526	8707	8526	8707	8707
	ft/in	28'0"	28'7"	28'0"	28'7"	28'7"
Overall height with bucket at full raise	mm	5893	5893	5893	5893	5893
	ft/in	19'4"	19'4"	19'4"	19'4"	19'4"
Loader clearance circle with bucket in carry position	mm	14 782	14 936	14 782	14 936	14 936
	ft/in	48'6"	49'0"	48'6"	49'0"	49'0"
Static tipping load, straight***	kg	16 770	16 595	16 850	16 674	16 897
	lb	36,961	36,525	37,137	36,749	37,241
Static tipping load, full 35° turn***	kg	15 120	14 944	15 202	15 026	15 232
	lb	33,339	32,951	33,520	33,132	33,586
Breakout force****	kN	183.5	182.7	184.2	183.3	195.7
	lb	41,288	41,108	41,445	41,243	44,033
Operating weight***	kg	23 224	23 397	23 153	23 526	23 243
	lb	51,209	51,590	51,052	51,434	51,251

*Material handling buckets discharge at less than 45° as measured from the inside floor of the bucket at full lift, in accordance with SAE J732 JUN92.

**Reach at 45° discharge is measured at less than full lift for material handling buckets.

***Static tipping load and operating weight shown includes sound-suppressed cab and ROPS, 26.5-25, tires, full fuel tank, coolant, lubricants and operator.

****Measured 102 mm (4") behind tip of cutting edge with bucket hinge pin as pivot point in accordance with SAE J732 JUN92.

	Change in Operating Weight		Change in Articulated Static Tipping Load	
	kg	lb	kg	lb
Remove cab only, ROPS remains	-177	- 390	-150	- 331
26.5-25, 20 PR (L-3)	-211	- 465	-130	- 286
26.5-R25, GP-2B, (L-2/3) radial	- 35	- 77	- 22	- 47
23.5-25, 20 PR (L-3)	-754	-1663	-465	-1025
23.5-R25, GP-2B (L-2/3) radial	-664	-1464	-408	- 900
23.5-R25, XHA (L-3) radial	-580	-1279	-357	- 786

Bucket Type		General Purpose								
		Bolt-on Edges	Teeth & Segments*	Bolt-on Edges	Teeth*	Teeth & Segments*	Bolt-on Edges	Teeth*	Teeth & Segments*	
Ground Engaging Tools	Rated capacity (\$)	m ³ yd ³	5.7 7.5	5.6 7.25	5.4 7	5.4 7	5.3 6.75	5 6.5	5 6.5	4.9 6.25
	Struck capacity (\$)	m ³ yd ³	4.92 6.44	4.85 6.34	4.61 6.03	4.68 6.12	4.55 5.95	4.25 5.56	4.38 5.73	4.19 5.48
Width (\$)		mm ft/in	3447 11'4"	3533 11'7"	3447 11'4"	3533 11'7"	3533 11'7"	3447 11'4"	3533 11'7"	3533 11'7"
	Dump clearance at full lift and 45° discharge (\$)	mm ft/in	3271 10'9"	3160 10'4"	3311 10'10"	3160 10'4"	3201 10'6"	3374 11'1"	3201 10'6"	3265 10'9"
Reach at full lift and 45° discharge (\$)		mm ft/in	1545 5'1"	1656 5'5"	1516 5'0"	1656 5'5"	1627 5'4"	1469 4'10"	1627 5'4"	1581 5'2"
	Reach with lift arms horizontal and bucket level	mm ft/in	3021 9'11"	3177 10'5"	2971 9'9"	3177 10'5"	3127 10'3"	2891 9'6"	3127 10'3"	3047 10'0"
Digging depth (\$)		mm in	138 5	133 5	138 5	103 4	133 5	138 5	103 4	133 5
	Overall length (\$)	mm ft/in	9465 31'1"	9632 31'7"	9415 30'11"	9632 31'7"	9582 31'5"	9335 30'8"	9582 31'5"	9502 31'2"
Overall height with bucket at full raise (\$)		mm ft/in	6205 20'4"	6205 20'4"	6135 20'2"	6205 20'4"	6135 20'2"	6067 19'11"	6135 20'2"	6067 19'11"
	Loader clearance circle with bucket in carry position (\$)	mm ft/in	15 780 51'9"	15 937 52'3"	15 753 51'8"	15 937 52'3"	15 909 52'2"	15 710 51'7"	15 909 52'2"	15 865 52'1"
Static tipping load, straight** (\$)		kg lb	20 306 44,767	20 274 44,696	20 648 45,521	20 646 45,516	20 600 45,415	20 886 46,045	21 008 46,314	20 837 45,937
	Static tipping load at full 37° turn** (\$)	kg lb	18 146 40,005	18 109 39,923	18 483 40,748	18 465 40,708	18 431 40,633	18 707 41,241	18 819 41,488	18 655 41,127
Breakout force*** (\$)		kN lb	210 47,277	213 47,836	219 49,255	225 50,736	222 49,868	233 52,391	235 52,978	236 53,104
	Operating weight** (\$)	kg lb	29 773 65,638	29 831 65,765	29 519 65,078	29 666 65,402	29 576 65,203	29 426 64,873	29 411 64,839	29 484 65,000

*Dimensions are measured to the tip of the bucket teeth to provide accurate clearance data. SAE Standards specifies the cutting edge.

**Static tipping load and operating weight shown are based on standard machine configuration with 29.5-R25 1-Star (L-3) tires, full fuel tank, coolant, lubricants and operator.

***Measured 102 mm (4") behind tip of cutting edge with bucket hinge pin as pivot point in accordance with SAE J732 JUN92.

NOTE: Specifications and ratings conform to all applicable standards recommended by the Society of Automotive Engineers. SAE Standards J732 JUN92 govern loader ratings and are denoted in the text by (\$).

Change in Operating Weight Standard

Change in Articulated Static Tipping Load

	kg		lb		Standard		High Lift	
	kg	lb	kg	lb	kg	lb	kg	lb
29.5-25, 22 PR (L-3)	-323	- 712	-255	- 562	-235	- 517	-235	- 517
29.5-25, 22 PR (L-4)	+337	+ 743	+266	+ 586	+245	+ 540	+245	+ 540
29.5-25, 22 PR (L-5)	+951	+2097	+751	+1655	+691	+1523	+691	+1523
29.5-R25, 1-Star (L-2/L-3)	- 82	- 181	- 65	- 143	- 60	- 131	- 60	- 131
29.5-R25, 1-Star (L-5)	+868	+1914	+685	+1510	+631	+1390	+631	+1390

Bucket Type	General Purpose						Rock			High Lift Change in Specs
	Bolt-on Edges	Teeth*	Teeth & Segments*	Teeth*	Spade Teeth & Segments*	Spade With Teeth*	Spade No Teeth	Spade With Teeth*		
Ground Engaging Tools										
Rated capacity (\$)	m ³ yd ³	4.7 6	4.7 6	4.5 5.75	4.2 5.5	4.5 5.75	4.2 5.5	4.2 5.5	3.8 5	— —
Struck capacity (\$)	m ³ yd ³	3.87 5.06	4.03 5.27	3.81 4.98	3.66 4.79	3.73 4.88	3.53 4.62	3.53 4.62	3.53 4.25	— —
Width (\$)	mm ft/in	3447 11'4"	3533 11'7"	3533 11'7"	3533 11'7"	3492 11'5"	3492 11'5"	3492 11'5"	3492 11'5"	— —
Dump clearance at full lift and 45° discharge (\$)	mm ft/in	3448 11'4"	3265 10'9"	3342 11'0"	3342 11'0"	3206 10'6"	3206 10'6"	3415 11'2"	3271 10'9"	221 9"
Reach at full lift and 45° discharge (\$)	mm ft/in	1419 4'8"	1581 5'2"	1534 5'0"	1534 5'0"	1798 5'11"	1798 5'11"	1580 5'2"	1760 5'9"	— —
Reach with lift arms horizontal and bucket level	mm ft/in	2801 9'2"	3047 10'0"	2957 9'8"	2957 9'8"	3243 10'8"	3243 10'8"	2940 9'8"	3169 10'5"	160 6"
Digging depth (\$)	mm in	138 5	103 4	133 5	103 4	133 5	103 4	103 4	103 4	— —
Overall length (\$)	mm ft/in	9245 30'4"	9502 31'2"	9412 30'11"	9412 30'11"	9687 31'9"	9687 31'9"	9357 30'8"	9614 31'7"	199 8"
Overall height with bucket at full raise (\$)	mm ft/in	5994 19'8"	6067 19'11"	5994 19'8"	5994 19'8"	6360 20'10"	6360 20'10"	6360 20'10"	6282 20'7"	221 9"
Loader clearance circle with bucket in carry position (\$)	mm ft/in	15 662 51'5"	15 865 52'1"	15 815 51'11"	15 815 51'11"	15 757 51'8"	15 757 51'8"	15 563 51'1"	15 718 51'7"	225 9"
Static tipping load, straight** (\$)	kg lb	21 122 46,566	21 208 46,755	21 071 46,453	21 468 47,328	20 428 45,036	20 942 46,169	21 274 46,901	21 040 46,385	(1830) (4034)
Static tipping load, full 37° turn** (\$)	kg lb	18 932 41,737	19 010 41,909	18 878 41,618	19 256 42,452	18 256 40,247	18 753 41,343	19 086 42,077	18 848 41,552	(1680) (3704)
Breakout force*** (\$)	kN lb	251 56,386	251 56,583	254 57,216	272 61,214	207 46,485	224 50,473	228 51,228	233 52,488	— —
Operating weight** (\$)	kg lb	29 325 64,650	29 319 64,637	29 383 64,778	29 218 64,414	29 770 65,631	29 497 65,029	29 247 64,478	29 449 64,923	105 231

*Dimensions are measured to the tip of the bucket teeth to provide accurate clearance data. SAE Standards specifies the cutting edge.

**Static tipping load and operating weight shown are based on standard machine configuration with 29.5-R25 1-Star (L-3) tires, full fuel tank, coolant, lubricants and operator.

***Measured 102 mm (4") behind tip of cutting edge with bucket hinge pin as pivot point in accordance with SAE J732 JUN92.

NOTE: Specifications and ratings conform to all applicable standards recommended by the Society of Automotive Engineers. SAE Standards J732 JUN92 govern loader ratings and are denoted in the text by (\$).

Change in Operating Weight Standard

Change in Articulated Static Tipping Load

	kg	lb
29.5-25, 22 PR (L-3)	-323	- 712
29.5-25, 22 PR (L-4)	+337	+ 743
29.5-25, 22 PR (L-5)	+951	+2097
29.5-R25, 1-Star (L-2/L-3)	- 82	- 181
29.5-R25, 1-Star (L-5)	+868	+1914

Standard		High Lift	
kg	lb	kg	lb
-255	- 562	-235	- 517
+266	+ 586	+245	+ 540
+751	+1655	+691	+1523
- 65	- 143	- 60	- 131
+685	+1510	+631	+1390

Rock Buckets		Standard							High Lift Spade-edge With Teeth*
		Spade-edge						Straight-edge With DST & BOS*	
		With Teeth**	Bare	With DST & BOS*	With BOCE*	Modulok	Quarry▶		
Capacity, heaped	m ³ yd ³	6.1 8	6.1 8	6.3 8.25	6.1 8	6 8	6.9 9	6.1 8	5.6 7.25
Capacity, struck (§)	m ³ yd ³	5.04 6.59	5.04 6.59	5.27 6.89	5.1 6.6	5.1 6.6	5.6 7.3	5.1 6.6	4.6 6
Width (§)	mm ft/in	3772 12'5"	3772 12'5"	3772 12'5"	3772 12'5"	3776 12'5"	3980 13'1"	3772 12'5"	3772 12'5"
Dump clearance at full lift and 45° discharge (§)	mm ft/in	3209 10'7"	3496 11'6"	3176 10'5"	3393 11'2"	3240 10'8"	3218 10'7"	3434 11'3"	3675 12'1"
Reach at full lift and 45° discharge (§)	mm ft/in	1611 5'3"	1611 5'3"	1658 5'5"	1658 5'5"	1671 5'6"	1688 5'6"	1685 5'6"	1684 5'6"
Reach at 45° dump and 2130 mm (7'0") height (§)	mm ft/in	2248 7'5"	2340 7'8"	2279 7'6"	2356 7'9"	2316 7'7"	2326 7'7"	2395 7'10"	2600 8'6"
Reach with lift arms horizontal and bucket level	mm ft/in	3089 10'2"	3089 10'2"	3196 10'6"	3196 10'6"	3202 10'6"	3239 10'8"	3234 10'8"	3382 11'1"
Digging depth (§)	mm in	82 3"	82 3"	123 5"	123 5"	111 4"	123 5"	123 5"	135 5"
Overall length (§)	mm ft/in	10 928 35'10"	10 589 34'9"	11 000 36'1"	10 728 35'2"	10 938 35'11"	10 961 36'0"	10 655 35'0"	11 314 37'1"
Overall height with bucket at full raise (§)	mm ft/in	6852 22'6"	6852 22'6"	6852 22'6"	6852 22'6"	6852 22'6"	6890 22'7"	6720 22'0"	7236 23'9"
Loader clearance circle with bucket in carry position (§)	mm ft/in	16 966 55'8"	16 754 55'0"	17 002 55'9"	16 966 55'8"	16 986 55'9"	17 138 56'3"	16 988 55'9"	17 340 56'11"
Static tipping load, straight† (§)	kg lb	30 794 67,747	30 967 68,127	29 875 65,725	30 371 66,816	29 996 65,991	30 090 66,198	30 692 67,522	26 365 58,003
Static tipping load, full 35° turn† (§)	kg lb	27 596 60,711	27 770 61,094	26 699 58,738	27 179 59,794	26 798 58,956	26 910 59,202	27 502 60,504	23 524 51,753
Breakout force†† (§)	kg lb	37 401 82,282	37 596 82,652	34 500 75,900	34 742 76,432	35 785 78,727	34 686 76,309	42 267 92,987	39 114 86,051
Operating weight††	kg lb	45 678 100,492	45 481 100,267	46 111 101,655	45 941 101,070	46 274 101,803	46 085 101,387	45 693 100,525	46 114 101,451

* DST & BOS = Double Strap Teeth and Bolt-On Segments, BOCE = Bolt-On Cutting Edge.

** Dimensions measured to end of teeth and do not conform to SAE standards.

▶ Specification is with BOS and DST.

† Static tipping load and operating weight are based on standard machine configuration with 35/65-33, 30 PR (L-4) tires, full fuel tank, coolant, lubricants and operator.

†† Measured 102 mm (4") behind tip of cutting edge with bucket hinge pin as pivot point in accordance with SAE J732 JUN92.

NOTE: Specifications and ratings conform to all applicable standards recommended by the Society of Automotive Engineers. SAE Standard J732 JUN92 and J742 FEB85 govern loader ratings, denoted in the text by (§).

	Change in Operating Weight		Change in Articulated Static Tipping Load			
	Standard		Standard		High Lift	
	kg	lb	kg	lb	kg	lb
Remove cab only	- 480	-1058	- 487	-1074	- 438	- 966
Remove ROPS canopy and cab	-2257	-4976	-2625	-5787	-2337	-5152
35/65-33, 24 PR (L-5) tires	+ 493	+1087	+ 349	+ 769	+ 310	+ 683
35/65 R33, (L-5) equivalent tires	- 588	-1290	- 416	- 917	- 369	- 813

Standard Rock Buckets		Spade-edge						Straight-edge	
		With Teeth**	Bare	With DST & BOS*	With BOCE*	Modulok	Quarry	With DST & BOS*	With BOCE*
Capacity, heaped	m ³ yd ³	8.4 11	8.4 11	8.6 11.2	8.6 11.2	8.6 11.2	9.2 12	8.6 11.2	8.6 11.2
Capacity, struck	m ³ yd ³	6.9 9	6.9 9	7 9.1	7 9.1	7.2 9.4	7.5 9.8	7 9.1	7 9.1
Width (§)	mm ft/in	4450 14'7"	4450 14'7"	4450 14'7"	4500 14'9"	4490 14'8"	4610 15'2"	4450 14'7"	4500 14'9"
Dump clearance at full lift and 45° discharge (§)	mm ft/in	4046 13'3"	4367 14'4"	4046 13'3"	4254 13'11"	4026 13'3"	3989 13'1"	4454 14'7"	4641 15'3"
Reach at full lift and 45° discharge (§)	mm ft/in	1986 6'6"	1986 6'6"	2042 6'8"	2042 6'8"	2049 6'8"	2099 6'11"	1956 6'5"	1956 6'5"
Reach at 45° dump and 2130 mm (7'0") height (§)	mm ft/in	2965 9'9"	3026 9'11"	3022 9'11"	3064 10'1"	3024 9'11"	3065 10'1"	3009 9'10"	3029 9'11"
Reach with lift arms horizontal and bucket level	mm ft/in	3822 12'6"	3822 12'6"	3942 12'11"	3942 12'11"	3947 12'11"	4022 13'2"	3582 11'9"	3582 11'9"
Digging depth (§)	mm in	72 2.8"	72 2.8"	112 4.4"	112 4.4"	107 4.2"	112 4.4"	112 4.4"	112 4.4"
Overall length (§)	mm ft/in	12 610 41'4"	12 170 39'11"	12 610 41'4"	12 322 40'5"	12 646 41'6"	12 689 41'8"	12 249 40'2"	11 962 39'3"
Overall height with bucket at full raise (§)	mm ft/in	8130 26'8"	8130 26'8"	8130 26'8"	8130 26'8"	8130 26'8"	8130 26'8"	8130 26'8"	8130 26'8"
Loader clearance circle with bucket in carry position (§)	mm ft/in	20 578 67'6"	20 496 67'3"	20 578 67'6"	20 624 67'8"	20 608 67'7"	20 726 68'0"	20 606 67'7"	20 652 67'9"
Static tipping load, straight† (§)	kg lb	40 996 90,191	41 567 91,447	40 203 88,447	40 403 88,887	39 387 86,651	39 606 87,133	40 742 89,632	40 960 90,112
Static tipping load, full 35° turn† (§)	kg lb	37 139 81,706	37 709 82,960	36 356 79,983	36 556 80,423	35 561 78,234	35 778 78,712	36 903 81,187	37 120 81,664
Breakout force†† (§)	kg lb	63 106 138,833	63 523 139,751	58 772 129,298	58 937 129,661	58 213 128,069	56 162 123,556	72 917 160,417	73 113 160,850
Operating weight††	kg lb	73 453 161,597	73 023 160,651	73 971 162,736	73 825 162,415	74 454 163,800	74 315 163,493	73 520 161,744	73 357 161,385

* DST & BOS = Double Strap Teeth and Bolt-On Segments, BOCE = Bolt-On Cutting Edge.

** Dimensions measured to end of teeth and do not conform to SAE standards.

† Static tipping load and operating weight are based on standard machine configuration with 41.25/70-39, 34 PR (L-5) tires, full fuel lubricants and operator.

†† Measured 102 mm (4") behind tip of cutting edge with bucket hinge pin as pivot point in accordance with SAE J732 JUN92.

NOTE: Specifications and ratings conform to all applicable standards recommended by the Society of Automotive Engineers. SAE Standard J732 JUN92 and J742 FEB85 govern loader ratings, denoted in the text by (§).

Rock Buckets		Standard Spade Edge		Large Standard Spade Edge		Light Aggregate Spade Edge		Heavy Duty Mining		
		Teeth & Segments		Teeth & Segments		Teeth & Segments		Teeth		
		Std.	Hi-Lift	Std.	Hi-Lift	Std.	Hi-Lift	Std.	Hi-Lift	
Rated capacity (\$)	m ³ yd ³	11.5 15	11.5 15	12.3 16	12.3 16	11.5 15	11.5 15	12 15.5	12 15.5	
Struck capacity (\$)	m ³ yd ³	9.39 12.1	9.39 12.1	10.1 13.1	10.1 13.1	9.39 12.1	9.39 12.1	9.86 12.9	9.86 12.9	
Width (\$)	mm ft/in	4824 15'10"	4824 15'10"	4824 15'10"	4824 15'10"	4824 15'10"	4824 15'10"	4840 15'11"	4840 15'11"	
Dump clearance at full lift and 45° discharge (\$)	With teeth:	mm ft/in	4636 15'3"	5256 17'3"	4636 15'3"	5256 17'3"	4695 15'5"	5315 17'5"	4623 15'2"	5243 17'2"
	Bare:	mm ft/in	5003 16'5"	5623 18'5"	5003 16'5"	5623 18'5"	5009 16'5"	5629 18'6"	5003 16'5"	5623 18'5"
Reach at full lift and 45° discharge (\$)	With teeth:	mm ft/in	2303 7'7"	2299 7'6"	2303 7'7"	2299 7'6"	2261 7'5"	2256 7'5"	2363 7'9"	2358 7'9"
	Bare:	mm ft/in	1699 5'7"	1694 5'7"	1699 5'7"	1694 5'7"	1699 5'7"	1694 5'7"	1729 5'8"	1725 5'8"
Reach with boom – horizontal and bucket level	With teeth:	mm ft/in	5105 16'9"	5585 18'4"	5105 16'9"	5585 18'4"	5033 16'6"	5513 18'1"	5156 16'11"	5636 18'6"
	Bare:	mm ft/in	4663 15'4"	5143 16'10"	4663 15'7"	5143 16'10"	4661 15'4"	5141 16'10"	4663 15'4"	5143 16'10"
Digging depth (\$)	mm in	140 5.5"	144 5.7"	140 5.5"	144 5.7"	140 5.5"	144 5.7"	149 5.9"	149 5.9"	
Overall length (\$)	With teeth:	mm ft/in	15 585 51'2"	16 175 53'1"	15 585 51'2"	16 175 53'1"	15 513 50'11"	16 103 52'10"	15 636 51'4"	16 226 53'3"
	Bare:	mm ft/in	15 143 49'8"	15 733 51'7"	15 143 49'8"	15 733 51'7"	15 141 49'8"	15 731 51'7"	15 143 49'8"	15 733 51'7"
Overall height with bucket at full raise (\$)	mm ft/in	9415 30'11"	10 035 32'11"	9415 30'11"	10 035 32'11"	9415 30'11"	10 035 32'11"	9415 30'11"	10 035 32'11"	
Loader clearance circle with bucket in carry position (\$)	With teeth:	mm in	22 272 73'1"	22 876 75'1"	22 272 73'1"	22 876 75'1"	22 216 72'11"	22 818 74'10"	22 310 73'2"	22 918 75'2"
	Bare:	mm in	21 882 71'9"	22 464 73'8"	21 882 71'9"	22 464 73'8"	21 882 71'9"	22 464 73'8"	21 942 72'	22 512 73'10"
Static tipping load, straight†	kg lb	56 782 124,920	55 951 123,092	56 802 124,964	56 117 123,457	57 371 126,216	56 179 123,594	55 036 121,079	55 079 121,174	
Static tipping load, full 43° turn†	kg lb	49 035 107,877	47 877 105,329	49 019 107,842	48 004 105,609	49 632 109,190	48 112 105,846	47 344 104,157	47 053 103,517	
Breakout force†† (\$)	kg lb	62 655 137,841	61 203 134,647	62 413 137,309	61 203 134,647	63 139 138,906	61 929 135,244	58 059 127,730	56 849 125,068	
Operating weight† (\$)	kg lb	91 810 201,982	94 921 208,826	92 045 202,499	95 156 209,343	91 171 200,576	94 281 207,418	93 141 204,910	96 251 211,752	

† Static tipping load and operating weight shown are based on standard machine configuration with 45/65-45, 46 PR (L-5) tires, full fuel tank, coolant, lubricants and operator.

†† Measured 102 mm (4") behind tip of segments with bucket hinge pin as pivot point not in accordance with SAE J732 JUN92.

NOTE: Specifications and ratings conform to all applicable standards recommended by the Society of Automotive Engineers. SAE Standards J732 JUN92 govern loader ratings and are denoted in the text by (\$). Dimensions are also measured to the tip of the bucket teeth to provide accurate clearance data. SAE Standards specifies the cutting edge.

Change in Operating Weight

Change in Articulated Static Tipping Load

	Standard (for four tires)		Standard		High Lift	
	kg	lb	kg	lb	kg	lb
45/65-45, 46 ply L-5 Firestone	0	0	0	0	0	0
45/65-45, 46 ply L-5 General	+ 427	+ 940	+ 284	+ 625	+256	+ 564
45/65-45, 46 ply L-5 Goodyear	- 162	- 356	- 108	- 238	- 97	- 214
45/65 R45 1-Star L-4 (XLDD1) Michelin	-1942	-4272	-1290	-2838	-882	-1942
45/65 R45 1-Star L-5 (XLDD2) Michelin	- 681	-1500	- 452	- 994	-409	- 900
45/65 R45 1-Star L-5 (XMIND2) Michelin	+ 752	+1656	+ 523	+1151	+451	+ 994
45/65-45, 50PR L-5 Firestone	- 278	-612	- 167	-367	-167	- 367
45/65-45, 50PR L-5 Firestone	+ 441	+ 972	+ 265	+ 583	+265	+ 583

Performance Data
● 994 with 5650 mm (18'6") Bucket

Wheel Loaders

Bucket Type	Iron Ore***		Rock				Coal	High Lift	Equipped w/ 53.5/85-57 Tires	
	Spade With Teeth		Spade With Teeth				Straight w/Teeth	All Stand. Bkts. Avail.		
Ground Engaging Tools										
Capacity, rated (\$)	m ³ yd ³	10 13	12 16	14 18	16 21	18 23	20 26	30 40	Same Same	Same Same
Capacity, struck (\$)	m ³ yd ³	7.4 9.8	9.6 12.6	11.3 14.8	13 17	14.5 18.9	16.3 21.3	25.8 33.8	Same Same	Same Same
◆Width (\$)	mm ft/in	5650 18'6"	5650 18'6"	5650 18'6"	5650 18'6"	5650 18'6"	5650 18'6"	5650 18'6"	Same Same	Same Same
◆Dump clearance at full lift and 45° discharge (\$)	mm ft/in	6082 19'11"	6082 19'11"	5870 19'3"	5508 18'1"	5402 17'9"	5658 18'7"	5496 18'0"	+340 +1'1"	+180 +7"
◆Reach at full lift and 45° discharge	mm ft/in	1842 6'1"	1842 6'1"	2054 6'9"	2310 7'7"	2416 7'11"	2266 7'5"	2462 8'1"	+561 +1'10"	-200 -8"
◆Reach with lift arms horizontal, bucket level*	mm ft/in	4487 14'9"	4487 14'9"	4787 15'8"	5224 17'2"	5374 17'6"	5087 16'8"	5340 17'6"	+640 +2'1"	-200 -8"
◆Digging depth (\$)	mm in	246 9.7"	246 9.7"	246 9.7"	248 9.8"	248 9.8"	246 9.7"	222 8.7"	+14.1 +0.6"	-180 -7"
◆Overall length (\$)	mm ft/in	16 047 52'8"	16 047 52'8"	16 347 53'8"	16 839 55'3"	16 989 55'9"	16 647 54'7"	16 882 55'5"	+780 +2'7"	-130 -5.1"
Overall height bucket at full lift (\$)	mm ft/in	10 246 33'7"	10 696 35'1"	10 724 35'2"	10 749 35'3"	10 840 35'7"	11 276 37'0"	12 161 39'11"	+340 +1'1"	+180 +7"
Loader clearance circle with bucket in carry position	m ft/in	25.19 82'8"	25.19 82'8"	25.30 83'0"	25.5 83'8"	25.6 84'0"	25.50 83'8"	25.70 84'4"	+720 mm +2'4"	-40 mm -2"
◆Static tipping load, straight** (\$)	kg lb	120 910 266,600	122 050 269,100	119 780 264,100	118 620 261,500	116 090 255,400	130 340 287,400	117 670 259,400	0.82▶▶ 0.82▶▶	1.02▶▶ 1.02▶▶
◆Static tipping load, full 40° turn** (\$)	kg lb	104 840 231,100	105 790 233,200	103 630 228,500	102 380 225,200	100 040 220,100	112 310 247,600	101 620 224,000	0.80▶▶ 0.80▶▶	1.02▶▶ 1.02▶▶
Breakout force (\$)	kN lb	1370 308,000	1370 308,000	1165 262,000	1014 228,000	952 214,000	1010 228,000	900 202,000	0.96▶▶ 0.96▶▶	1.00▶▶ 1.00▶▶
◆Operating weight**	kg lb	174 600 385,000	174 800 385,500	175 500 387,000	177 000 399,000	178 000 392,000	177 900 392,300	177 100 390,500	+2500 +5520	+2600 +5720

*Reach is measured to tooth tip when applicable, otherwise to cutting edge.

**Static tipping load and operating weight include sound-suppressed cab and ROPS, 49.5-57 (L-4) tires, full fuel tank, coolant, lubricants and operator.

***Iron ore buckets with 75 mm (3") reversible bolt on segments. All other buckets with 50 mm (2") segments.

▶ Multiply this factor to standard rating to obtain High Lift rating.

◆ Varies with bucket tip, segment or wing configuration.

NOTE: Also available 30 m³ (35 yd³) general purpose coal bucket spade with teeth and segments.

NOTE: Specifications and ratings conform to all applicable standards recommended by the Society of Automotive Engineers. SAE Standards J732 JUN92 and J742 FEB85 govern loader ratings, denoted in the text by (\$).

	Change in Operating Weight		Change in Articulated Static Tipping Load	
	kg	lb	kg	lb
Remove ROPS canopy & cab	-3595	-7930	-2680	-5910
Remove cab only	-335	-740	-250	-550
Remove ROPS canopy only	-3260	-7190	-2430	-5360

Wheel Loaders

Performance Data

● 994 with 6220 mm (20'5") Bucket

Bucket Type		Iron Ore***		Rock				Coal	High Lift	Equipped w/ 53.5/85-57 Tires
		Spade With Teeth		Spade With Teeth				Straight w/Teeth	All Stand. Bkts. Avail.	
Ground Engaging Tools										
Capacity, rated (\$)	m ³ yd ³	11 14	12 16	14 18	16 21	18 23	20 26	30 40	Same Same	Same Same
Capacity, struck (\$)	m ³ yd ³	8.4 11	9.3 12.2	11 14.3	12.8 16.8	14.3 18.7	16.3 21.3	25.6 33.5	Same Same	Same Same
◆Width (\$)	mm ft/in	6220 20'5"	6220 20'5"	6220 20'5"	6220 20'5"	6220 20'5"	6220 20'5"	6220 20'5"	Same Same	Same Same
◆Dump clearance at full lift and 45° discharge (\$)	mm ft/in	5994 19'8"	5994 19'8"	5782 19'0"	5508 18'1"	5402 17'9"	5569 18'3"	5496 18'0"	+340 +1'1"	+180 +7"
◆Reach at full lift and 45° discharge	mm ft/in	1930 6'4"	1930 6'4"	2142 7'0"	2310 7'7"	2416 7'11"	2354 7'9"	2462 8'1"	+561 +1'10"	-200 -8"
◆Reach with lift arms horizontal, bucket level*	mm ft/in	4612 15'2"	4612 15'2"	4912 16'1"	5224 17'2"	5374 17'6"	5212 17'1"	5340 17'6"	+640 +2'1"	-200 -8"
◆Digging depth (\$)	mm in	246 9.7"	246 9.7"	246 9.7"	248 9.8"	248 9.8"	246 9.7"	222 8.7"	+14.1 +0.6"	-180 -7"
◆Overall length (\$)	mm ft/in	16 172 53'1"	16 172 53'1"	16 472 54'1"	16 839 55'3"	16 989 55'9"	16 772 55'0"	16 882 55'5"	+780 +2'7"	-130 -5.1"
Overall height bucket at full lift (\$)	mm ft/in	10 246 33'7"	10 406 33'7"	10 388 34'1"	10 507 34'6"	10 598 34'9"	10 990 36'1"	11 770 38'8"	+340 +1'1"	+180 +7"
Loader clearance circle with bucket in carry position	m ft/in	25.70 84'4"	25.70 84'4"	25.87 84'10"	25.5 83'8"	25.6 84'0"	26.00 85'4"	26.21 86'0"	+720 mm +2'4"	-40 mm -2"
◆Static tipping load, straight** (\$)	kg lb	118 560 261,400	118 620 261,500	116 390 256,600	116 460 256,200	115 160 253,900	113 720 250,700	115 100 253,700	0.82▶▶▶	1.02▶▶▶
◆Static tipping load, full 40° turn** (\$)	kg lb	102 510 226,000	102 520 226,000	100 400 221,300	100 340 220,700	98 940 217,700	97 700 215,400	99 160 218,600	0.80▶▶▶	1.02▶▶▶
Breakout force (\$)	kN lb	1275 287,000	1275 287,000	1095 247,000	956 215,000	903 203,000	960 216,000	900 202,000	0.96▶▶▶	1.00▶▶▶
◆Operating weight**	kg lb	176 200 388,500	176 400 389,000	177 100 390,500	179 000 393,000	180 000 396,000	179 600 395,900	178 800 394,100	+2500 +5520	+2600 +5720

*Reach is measured to tooth tip when applicable, otherwise to cutting edge.

**Static tipping load and operating weight include sound-suppressed cab and ROPS, 49.5-57 (L-4) tires, full fuel tank, coolant, lubricants and operator.

***Iron ore buckets with 75 mm (3") reversible bolt on segments. All other buckets with 50 mm (2") segments.

▶ Multiply this factor to standard rating to obtain High Lift rating.

◆ Varies with bucket tip, segment or wing configuration.

NOTE: Also available 30 m³ (35 yd³) general purpose coal bucket spade with teeth and segments.

NOTE: Specifications and ratings conform to all applicable standards recommended by the Society of Automotive Engineers. SAE Standards J732 JUN92 and J742 FEB85 govern loader ratings, denoted in the text by (\$).

	Change in Operating Weight		Change in Articulated Static Tipping Load	
	kg	lb	kg	lb
Remove ROPS canopy & cab	-3595	-7930	-2680	-5910
Remove cab only	-335	-740	-250	-550
Remove ROPS canopy only	-3260	-7190	-2430	-5360

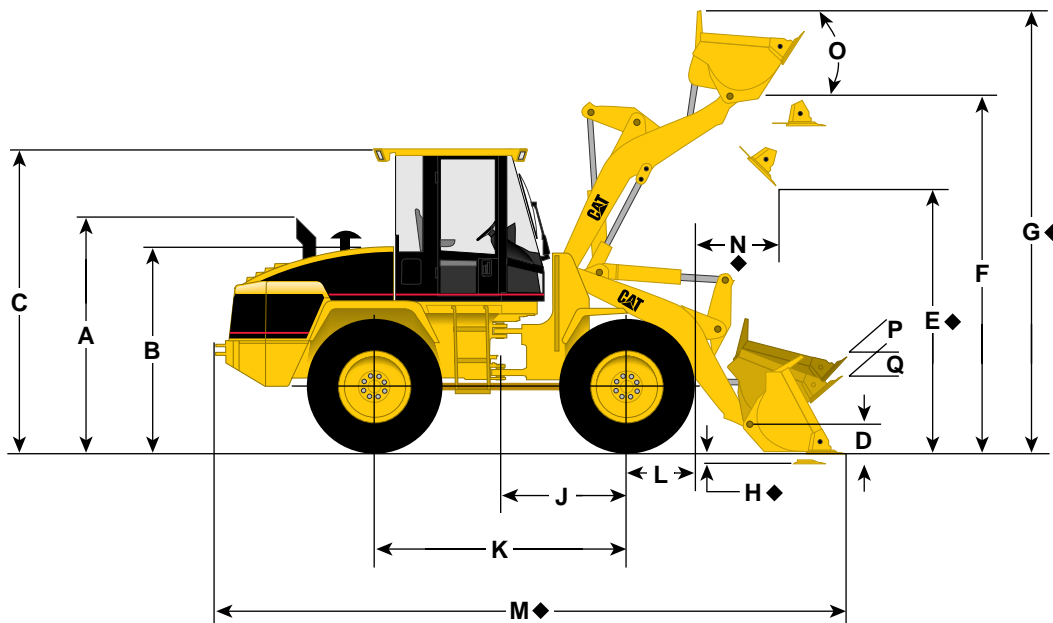

Dimensions shown represent standard machine with General Purpose bucket (bolt-on cutting edge) and standard tires.

◆ Varies with Bucket Size and/or Bucket Configuration — Refer to Performance Data

MODEL:	902 General Purpose Bolt-on edge		906 General Purpose Bolt-on edge		914G General Purpose Bolt-on edge	
	0.6 m ³	0.78 yd ³	0.8 m ³	1.05 yd ³	1.3 m ³	1.7 yd ³
A Height to top of stack	2.69 m	8'10"	2.72 m	8'11"	2.26 m	7'5"
B Height to top of engine compartment	1.78 m	5'10"	1.82 m	6'0"	2.08 m	6'10"
C Height to top of ROPS	2.65 m	8'8"	2.68 m	8'10"	3.1 m	10'2"
D Hinge pin height at carry position	330 mm	13"	416 mm	16"	374 mm	15"
E Dump clearance at full lift and 45° discharge angle	2.31 m	7'7"	2.39 m	7'10"	2.66 m	8'9"
F Hinge pin height at full lift	3.02 m	9'11"	3.13 m	10'3"	3.44 m	11'3"
G Maximum overall height	3.97 m	13'0"	4.17 m	13'8"	4.39 m	14'5"
H Maximum digging depth	68 mm	2.7"	100 mm	3.9"	89 mm	3.5"
J Machine center point to axle	1.0 m	3'3"	1.0 m	3'3"	1.3 m	4'3"
K Wheelbase	2.0 m	6'7"	2.0 m	6'7"	2.6 m	8'6"
L Free radius of tire	440 mm	17"	475 mm	17"	670 mm	2'2"
M Maximum overall length	5.2 m	17'4"	5.36 m	17'7"	6.23 m	20'5"
N Reach at full lift	764 mm	2'6"	982 mm	3'3"	973 mm	3'2"
O Maximum rollback at maximum lift	63°		63°		60°	
P Maximum rollback at carry height	50°		53°		46°	
Q Maximum rollback at ground	44°		43°		41°	
Ground clearance (std. tires)	282 mm	11.1"	317 mm	12.5"	456 mm	18"
Tread width (std. tires)	1.35 m	4'5"	1.4 m	4'7"	1.8 m	5'10.9"
Width over tires (std. tires)	1.7 m	4'3"	1.74 m	5'9"	2.26 m	7'4.9"
Tires used for measurements	12.5-18		12.5-20		17.5-R25 (L-2)	

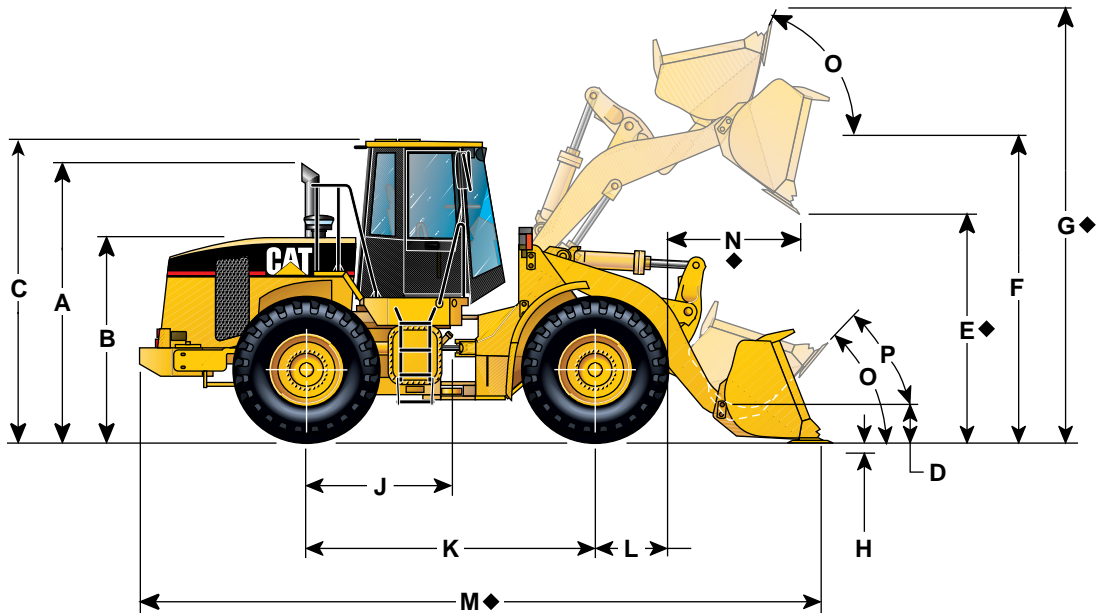

Dimensions shown represent standard machine with bucket, bolt-on cutting edge, and standard tires.

◆ Varies with Bucket Size and/or Bucket Configuration — Refer to Performance Data.

MODEL:	924F Loose Material Bolt-on edge		928G General Purpose Bolt-on edge		938G General Purpose Bolt-on edge		950G General Purpose Bolt-on edge	
	1.5 m ³	2.00 yd ³	2.2 m ³	2.9 yd ³	2.5m ³	3.25 yd ³	3.1 m ³	4 yd ³
A Height to top of stack	3.07 m	10'1"	3.11 m	10'2"	3.23 m	10'7"	3.22 m	10'7"
B Height to top of engine compartment	2.14 m	7'0"	2.16 m	7'1"	2.36 m	7'9"	2.25 m	7'5"
C Height to top of ROPS	3.14 m	10'4"	3.27 m	10'8"	3.3 m	10'10"	3.37 m	11'1"
D Hinge pin height at carry position	415 mm	16"	449 mm	18"	419 mm	16.5"	230 mm	9"
E Dump clearance at full lift and 45° discharge angle	2.70 m	8'10"	2.84 m	9'4"	2.85 m	9'4"	2.85 m	9'4"
F Hinge pin height at full lift	3.59 m	11'9"	3.87 m	12'8"	3.84 m	12'7"	3.98 m	13'1"
G Maximum overall height	4.68 m	15'4"	5.07 m	16'8"	5.08 m	16'8"	5.26 m	17'3"
H Maximum digging depth	93 mm	3.6"	86 mm	3.4"	48 mm	1.9"	101 mm	3.97"
J Machine center point to axle	1.35 m	4'5"	1.45 m	4'9"	1.510 m	4'11"	1.68 m	5'6"
K Wheelbase	2.70 m	8'10"	2.90 m	9'6"	3.020 m	9'11"	3.35 m	11'0"
L Radius of wheel	677 mm	2'3"	752 mm	2'6"	750 mm	2'6"	818 mm	2'8"
M Maximum overall length	6.52 m	21'5"	7.81 m	24'0"	7.28 m	23'9"	8.05 m	26'5"
N Reach at full lift	855 mm	2'10"	964 mm	3'2"	1004 mm	3'3.5"	1.29 m	4'3"
O Maximum rollback at maximum lift	58°		58°		65°		59°	
P Maximum rollback at carry height	45°		47.8°		46°		45°	
Q Maximum rollback at ground	40°		44°		41°		37.5°	
Ground clearance (std. tires)	318 mm	12.5"	408 mm	16"	400 mm	15.7"	400 mm	16"
Tread width (std. tires)	1.85 m	6'1"	1.82 m	6'1"	2.02 m	5'8"	2.14 m	7'0"
Width over tires (std. tires)	2.33 m	7'8"	2.44 m	8'0"	2.61 m	8'6"	2.89 m	9'6"
Tires used for measurements	17.5-25 (L-2)		20.5-25 (L-2)		20.5-R25 (L-2)		23.5-R25, XHA (L-3)	

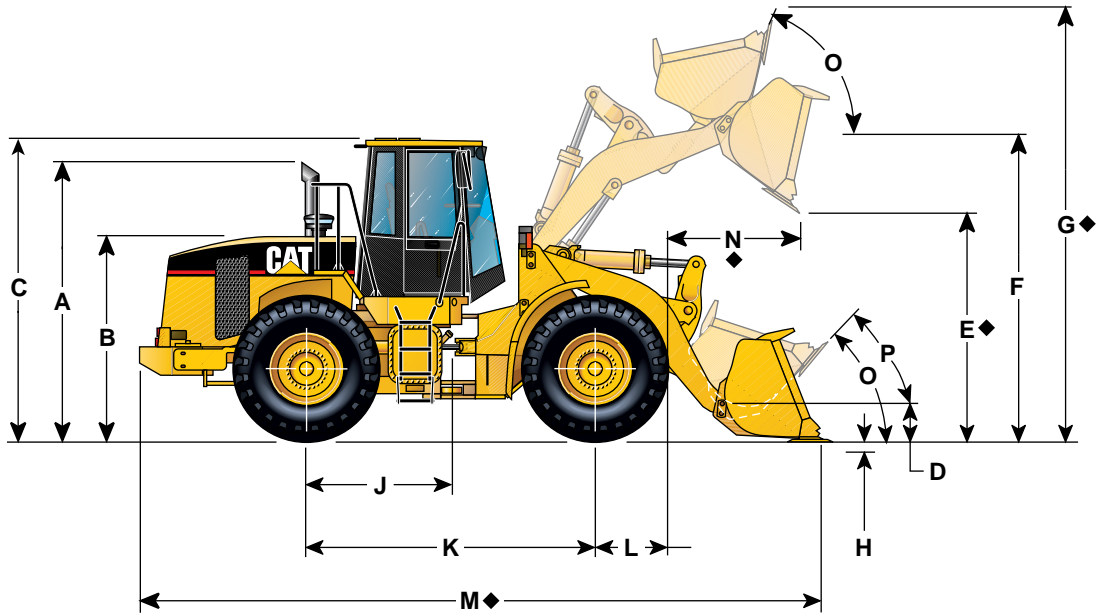

Dimensions shown represent standard machine with bucket, bolt-on cutting edge, and standard tires.

◆ Varies with Bucket Size and/or Bucket Configuration — Refer to Performance Data.

MODEL:	962G Material Handler Bolt-on edge		966F Series II General Purpose Bolt-on edge		970F Material Handling Bolt-on edge		980G General Purpose Bolt-on edge	
	3.5 m ³	4.5 yd ³	3.8 m ³	5 yd ³	4.7 m ³	6 yd ³	5.7 m ³	7.5 yd ³
A Height to top of stack	3.22 m	10'7"	3.4 m	11'2"	3.4 m	11'3"	3.39 m	11'1"
B Height to top of engine compartment	2.25 m	7'5"	2.46 m	8'1"	2.48 m	8'1"	2.33 m	7'8"
C Height to top of ROPS	3.37 m	11'1"	3.43 m	11'3"	3.43 m	11'3"	3.75 m	12'4"
D Hinge pin height at carry position	230 mm	9"	470 mm	18.5"	470 mm	18.5"	453 mm	18"
E Dump clearance at full lift and 45° discharge angle	2.97 m	9'8"	2.98 m	9'9"	3.23 m	10'6"	3.27 m	10'9"
F Hinge pin height at full lift	4.17 m	13'8"	4.12 m	13'6"	4.43 m	14'7"	4.50 m	14'9"
G Maximum overall height	5.49 m	18'0"	5.59 m	18'4"	5.81 m	19'1"	6.20 m	20'4"
H Maximum digging depth	98 mm	3.8"	76 mm	3"	76 mm	3"	138 mm	5"
J Machine center point to axle	1.68 m	5'6"	1.675 m	5'6"	1.675 m	5'6"	1.85 m	6'1"
K Wheelbase	3.35 m	11'0"	3.350 m	11'0"	3.35 m	11'0"	3.70 m	12'2"
L Radius of wheel	818 mm	2'8"	864 mm	2'10"	864 mm	2'10"	928 mm	36.6"
M Maximum overall length	8.21 m	27'5"	8.30 m	27'4"	8.68 m	28'6"	9.46 m	31'1"
N Reach at full lift	1.27 m	4'2"	1275 mm	4'2"	1355 mm	4'5"	1.54 m	5'1"
O Maximum rollback at maximum lift	60°		59°		54.3°		61°	
P Maximum rollback at carry height	45°		48°		47°		46°	
Q Maximum rollback at ground	37.5°		40°		43°		36°	
Ground clearance (std. tires)	400 mm	16"	476 mm	18.7"	482 mm	19"	467 mm	18.4"
Tread width (std. tires)	2.14 m	7'0"	2.20 m	7'3"	2.20 m	7'3"	2.44 m	8'0"
Width over tires (std. tires)	2.89 m	9'6"	2.94 m	9'8"	2.94 m	9'8"	3.24 m	10'7"
Tires used for measurements	23.5-R25, XHA (L-3)		26.5-25 (L-3)		26.5-25 (L-3)		29.5-R25 (L-3)	

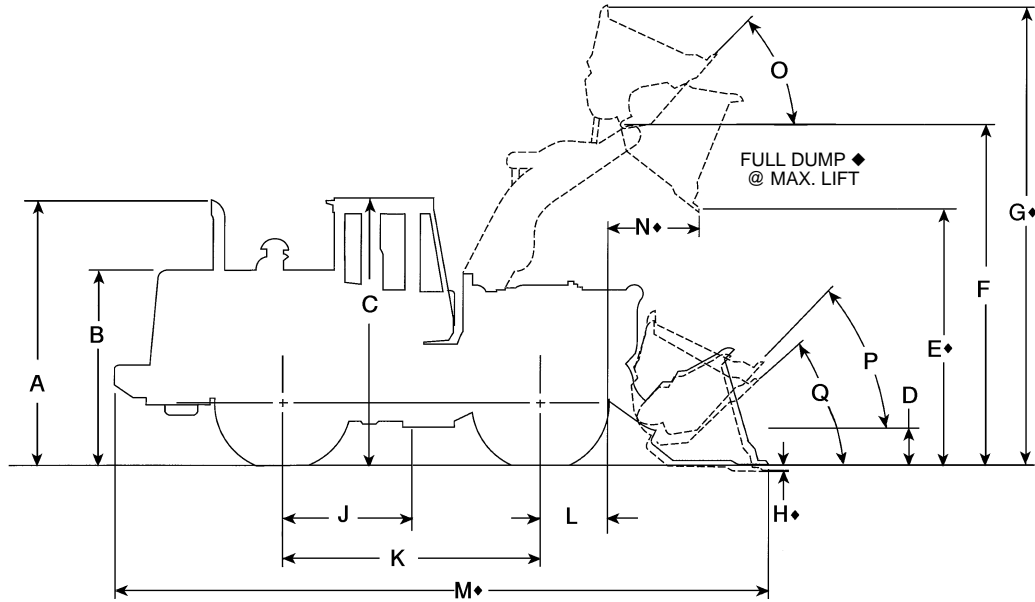

Dimensions shown represent standard machine with spade edge rock bucket and standard tires.

◆ Varies with Bucket Size and/or Bucket Configuration — Refer to Performance Data

MODEL:	980G General Purpose High Lift Bolt-on edge		988F Series II Spade Edge Rock With Teeth		988F Series II High Lift Spade Edge Rock With Teeth		990 Series II Spade Edge Rock With Teeth	
	5.7 m ³	7.5 yd ³	6 m ³	7.8 yd ³	5.6 m ³	7.25 yd ³	8.4 m ³	11 yd ³
A Height to top of stack	3.39 m	11'1"	3.97 m	13'0"	3.97 m	13'0"	4.59 m	15'5"
B Height to top of engine compartment	2.33 m	7'8"	2.98 m	9'9"	2.98 m	9'9"	3.46 m	11'4"
C Height to top of ROPS	3.75 m	12'4"	4.13 m	13'6"	4.13 m	13'6"	5.13 m	16'10"
D Hinge pin height at carry position	453 mm	18"	650 mm	2'4"	780 mm	2'4"	816 mm	2'8"
E Dump clearance at full lift and 45° discharge angle	3.49 m	11'6"	3.21 m	10'6"	3.72 m	12'2"	4.05 m	13'3"
F Hinge pin height at full lift	4.73 m	15'6"	4.90 m	16'1"	5.36 m	17'7"	5.90 m	19'4"
G Maximum overall height	6.42 m	21'1"	6.85 m	22'6"	7.23 m	23'9"	8.13 m	26'8"
H Maximum digging depth	138 mm	5"	98 mm	4"	146 mm	6"	72 mm	2.8"
J Machine center point to axle	1.85 m	6'1"	1.90 m	6'3"	1.90 m	6'3"	2.30 m	7'7"
K Wheelbase	3.70 m	12'2"	3.81 m	12'6"	3.81 m	12'6"	4.60 m	15'1"
L Radius of wheel	928 mm	36.6"	1.03 m	3'4"	1.03 m	3'4"	1.25 m	4'1"
M Maximum overall length	9.68 m	31'9"	10.99 m	36'1"	11.31 m	37'1"	12.61 m	41'4"
N Reach at full lift	1.54 m	5'1"	1.61 m	5'3"	1.68 m	5'6"	1.99 m	6'6"
O Maximum rollback at maximum lift	61°		63.3°		63.3°		64°	
P Maximum rollback at carry height	46°		50°		50°		48.4°	
Q Maximum rollback at ground	36°		40°		40°		39.1°	
Ground clearance (std. tires)	467 mm	18.4"	529 mm	1'9"	529 mm	1'9"	491 mm	1'7"
Tread width (std. tires)	2.44 m	8'0"	2.59 m	8'6"	2.59 m	8'6"	3.05 m	10'0"
Width over tires (std. tires)	3.25 m	10'8"	3.55 m	11'8"	3.55 m	11'8"	4.16 m	13'3"
Tires used for measurements	29.5-R25 (L-3)		35/65-33 (L-4)		35/65-33 (L-4)		41.25/70-39 (L-5)	

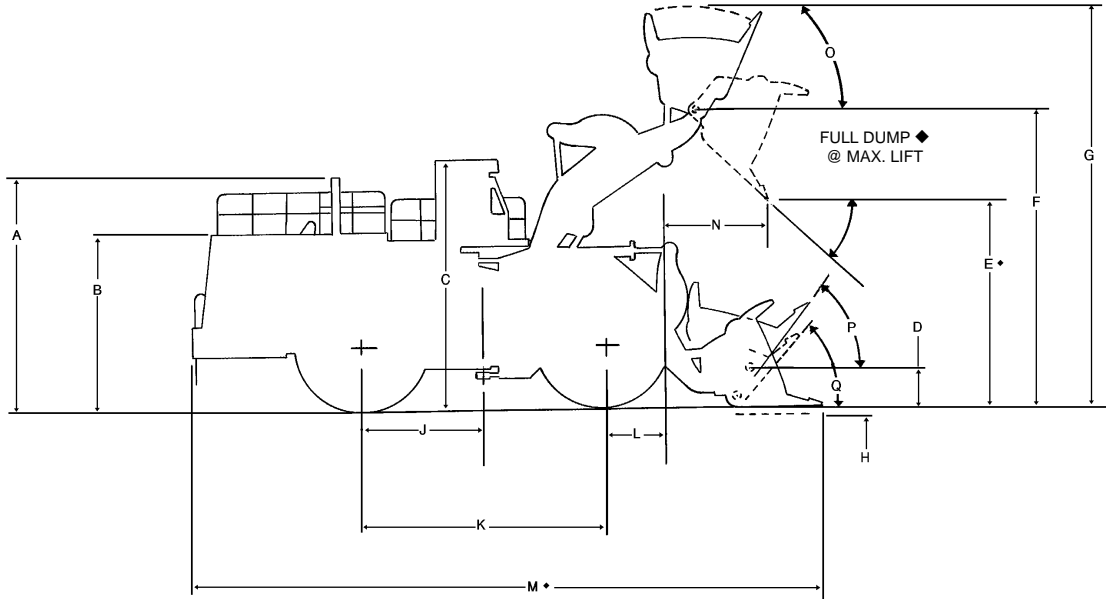

Dimensions shown represent standard machine with spade edge rock bucket and standard tires.

◆ Varies with Bucket Size and/or Bucket Configuration — Refer to Performance Data

MODEL:	992G Spade Edge Rock With Teeth		992G High Lift Spade Edge Rock With Teeth		994 5640 mm (18'6") Spade-Edge Bucket With Teeth And Segments		994 High Lift 5640 mm (18'6") Spade Edge Bucket With Teeth And Segments	
	11.5 m ³	15 yd ³	11.5 m ³	15 yd ³	16 m ³	21 yd ³	16 m ³	21 yd ³
A Height to top of stack	5.23 m	17'2"	5.23 m	17'2"	6.30 m	20'8"	6.30 m	20'8"
B Height to top of engine compartment	3.98 m	13'0"	3.98 m	13'0"	4.66 m	15'3"	4.66 m	15'3"
C Height to top of ROPS	5.59 m	18'4"	5.59 m	18'4"	6.53 m	21'5"	6.53 m	21'5"
D Hinge pin height at carry position	960 mm	3'1.8"	1125 mm	3'8.3"	1030 mm	3'5"	1258 mm	4'2"
◆ E Dump clearance at full lift and 45° discharge angle	4.63 m	15'3"	5.25 m	17'3"	5.51 m	18'1"	5.85 m	19'2"
◆ F Hinge pin height at full lift	6.94 m	22'9"	7.55 m	24'10"	7.98 m	26'2"	8.32 m	27'3"
◆ G Maximum overall height	9.41 m	30'11"	10.03 m	32'11"	10.75 m	35'3"	11.09 m	36'5"
◆ H Maximum digging depth	140 mm	5.5"	144 mm	5.7"	248 mm	9"	262 mm	10"
J Machine center point to axle	2.94 m	9'8"	2.94 m	9'8"	3.20 m	10'6"	3.20 m	10'6"
K Wheelbase	5.89 m	19'4"	5.89 m	19'4"	6.40 m	21'0"	6.40 m	21'0"
L Radius of wheel	1.37 m	4'6"	1.37 m	4'6"	1.80 m	5'11"	1.80 m	5'11"
◆ M Maximum overall length	15.58 m	49'8"	16.17 m	53'1"	16.84 m	55'3"	17.61 m	57'9"
◆ N Reach at full lift	2.3 m	7'7"	2.29 m	7'7"	2.31 m	7'7"	2.87 m	9'5"
O Maximum rollback at maximum lift	65°		65°		64°		64°	
P Maximum rollback at carry height	50°		50°		53°		58°	
Q Maximum rollback at ground	42°		42°		40°		40°	
Ground clearance (std. tires)	691 mm	2'3.2"	691 mm	2'3.2"	650 mm	2'2"	650 mm	2'2"
Tread width (std. tires)	3.30 m	10'10"	3.30 m	10'10"	3.90 m	12'10"	3.90 m	12'10"
Width over tires (std. tires)	4.50 m	14'9"	4.49 m	14'9"	5.20 m	17'1"	5.20 m	17'1"
Tires used for measurements	45/65-45 (L-5)		45/65-45 (L-5)		50/80-57 (L-4)		50/80-57 (L-4)	

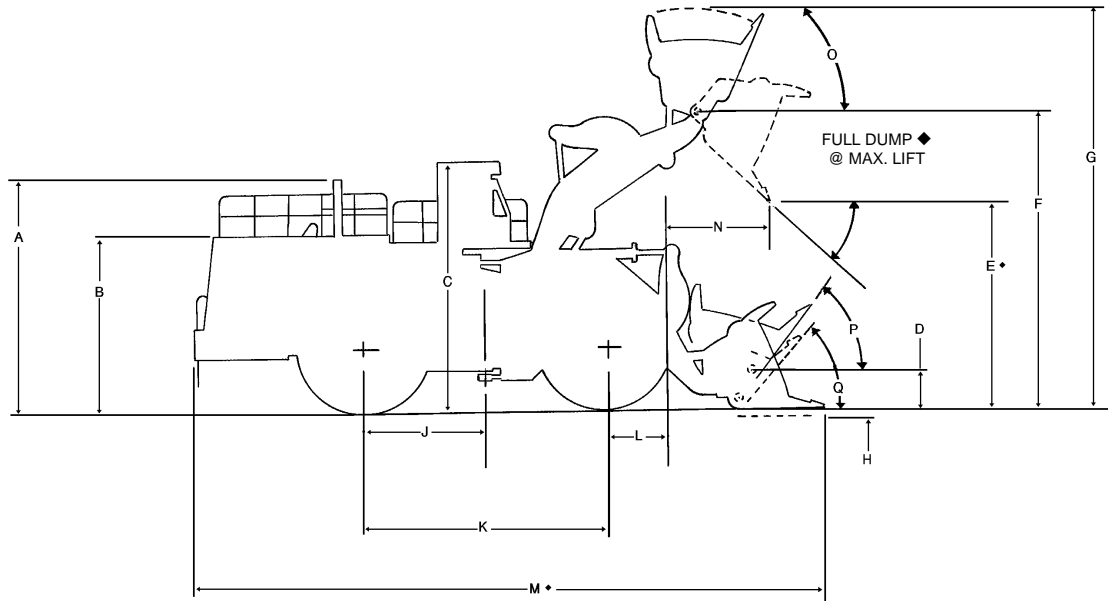

Dimensions shown represent standard machine with spade edge rock bucket and standard tires.

◆ Varies with Bucket Size and/or Bucket Configuration — Refer to Performance Data

MODEL:	994 5640 mm (18'6") Spade Edge Bucket With Teeth And Segments		994 High Lift 5640 mm (18'6") Spade Edge Bucket With Teeth And Segments	
	18 m ³	23 yd ³	18 m ³	23 yd ³
A Height to top of stack	6.48 m	21'3"	6.48 m	21'3"
B Height to top of engine compartment	4.84 m	15'11"	4.84 m	15'11"
C Height to top of ROPS	6.71 m	22'0"	6.71 m	22'0"
D Hinge pin height at carry position	1030 mm	3'5"	1258 mm	4'2"
◆ E Dump clearance at full lift and 45° discharge angle	5.58 m	18'4"	5.92 m	19'5"
◆ F Hinge pin height at full lift	8.16 m	26'9"	8.50 m	27'11"
◆ G Maximum overall height	11.02 m	36'2"	11.36 m	37'3"
◆ H Maximum digging depth	68 mm	3"	82 mm	3"
J Machine center point to axle	3.20 m	10'6"	3.20 m	10'6"
K Wheelbase	6.40 m	21'0"	6.40 m	21'0"
L Radius of wheel	2.00 m	6'7"	2.00 m	6'7"
◆ M Maximum overall length	16.86 m	55'4"	17.64 m	57'11"
◆ N Reach at full lift	2.42 m	7'11"	2.98 m	9'9"
O Maximum rollback at maximum lift		64°		64°
P Maximum rollback at carry height		53°		58°
Q Maximum rollback at ground		40°		40°
Ground clearance (std. tires)	830 mm	2'9"	830 mm	2'9"
Tread width (std. tires)	4.00 m	13'1"	4.00 m	13'1"
Width over tires (std. tires)	5.35 m	17'7"	5.35 m	17'7"
Tires used for measurements	53.5/85-57 (L-5)		53.5/85-57 (L-5)	

SPECIFICATION DEFINITIONS FOR FRONT END LOADERS

Caterpillar wheel and track loader specifications conform to Society of Automotive Engineers (SAE) definitions as expressed in standards J732 (JUN92), as follows:

Description of Specification Machine

On wheel loaders the tire inflation pressure at which specifications are taken must be described in addition to the current written basic machine description. On track loaders the type of grouser must be specified.

Hydraulic Cycle Times

- “Raise Time” — Time in seconds required to raise the bucket from level position on the ground.
- “Lower Time” — Time in seconds required to lower the empty bucket from the full height to a level position on the ground.
- “Dump Time” — Time in seconds required to move the bucket at maximum height from the maximum rollback position to full dump position while dumping the SAE loose material operating load.

Breakout Force

“Breakout force,” pounds (and kilonewtons or kilograms) — the maximum sustained vertical upward force exerted 100 mm (4”) behind the tip of the bucket cutting edge and achieved through the ability to lift and/or rollback about the specified pivot point under the following conditions:

- Loader on a hard level surface with transmission in neutral.
- All brakes released.
- Unit at standard operating weight — rear of loader not tied down.
- Bottom of cutting edge parallel to and not more than 20 mm (0.75”) above or below the ground line.

- When bucket circuit is used the pivot point must be specified as the bucket hinge pin, and the unit blocked under the bucket hinge pin pivot point in order to minimize linkage movement.
- When the lift circuit is used, the pivot point must be specified as the lift arm hinge pin. Wheel loaders shall have front axle blocked to eliminate change in position of pivot pins due to tire deflection.
- If both circuits are used simultaneously, the dominating pivot point listed in (e) or (f) must be specified.
- If the circuit used causes the rear of the vehicle to leave the ground, then the vertical force value required to raise the rear of the vehicle is the breakout force.
- For irregular shaped buckets, the tip of the bucket cutting edge referred to above shall mean the farther forward point of the cutting edge.

The following are illustrations used (according to provisions of SAE J732 JUN92) to measure Caterpillar Loader breakout forces.

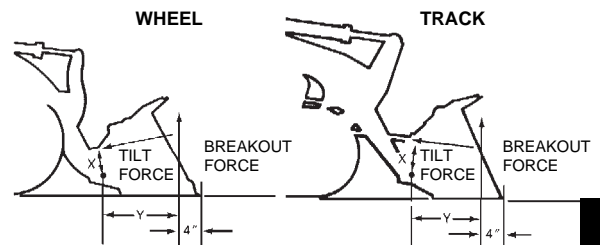

- Breakout force resulting from rackback:

$$(\text{Tilt Force}) \times (\text{Dist. "X"}) = (\text{"Y" Dist.}) \times (\text{Breakout Force})$$

$$\frac{(\text{Tilt Force}) \times (\text{Dist. "X"})}{\text{"Y" Dist.}} = \text{Breakout Force}$$

b. Breakout force resulting from bucket lift:

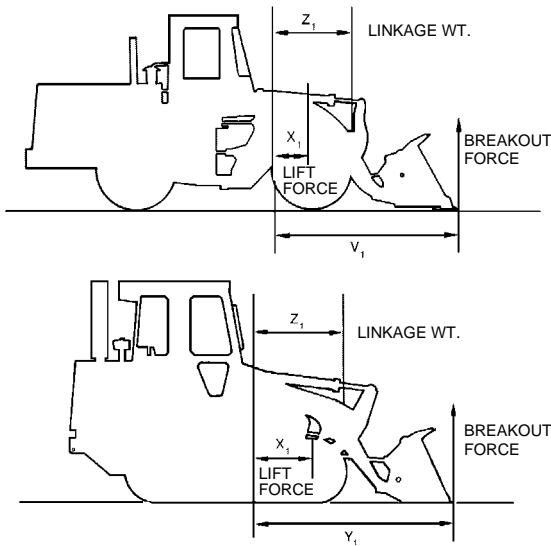

$$\begin{aligned}
 (\text{Lift Force}) \times (\text{Dist. "X}_1\text{")} &= (\text{"Y}_1\text{ Dist.}) \times (\text{Breakout Force}) \\
 &+ (\text{Linkage Wt.}) \times (\text{Dist. "Z}_1\text{")} \\
 &+ (\text{Breakout Force}) \\
 &\times (\text{Linkage Mechanical Advantage) "V}_1\text{"}
 \end{aligned}$$

$$\begin{aligned}
 \text{Breakout Force} &= \frac{(\text{Lift Force}) \times (\text{Dist. "X}_1\text{")} - (\text{Linkage Wt.}) \times (\text{Dist. "Z}_1\text{")}}{(\text{Dist. "Y}_1\text{") + (\text{Dist. "V}_1\text{")} \times (\text{Linkage Mech. Advantage})}
 \end{aligned}$$

Static Tipping Load

The minimum weight at center of gravity of “SAE Rated” load in bucket which will rotate rear of machine to a point where, on track loaders, front rollers are clear of the track and on wheel loaders, rear wheels are clear of the ground under the following conditions:

- a. Loader on hard level surface and stationary.
- b. Unit at standard operating weight.
- c. Bucket at maximum rollback position.
- d. Load at maximum forward position during raising cycle.
- e. For articulated wheel loaders, the test will be run both with frame straight (straight static tipping load) and fully turned to a specific angle (full turn static tipping load).

- f. Unit with standard equipment as described in specifications unless otherwise noted under the heading.

Operating Load

In order to comply with SAE standard J818 MAY87, the operating load of Wheel Loaders should not exceed 50% of the full turn Static Tipping load of the machine when equipped with attachments needed for the job. (For track loaders, operating load should not exceed 35% of the Static Tipping load rating.) See “Performance Data” of each machine in this handbook for increases to static tipping load by adding cab, counterweights, ripper-scarifier, etc.

Carry Position

SAE defines carry positions as: “The vertical distance from the ground to the center line of the bucket hinge pin, with the angle of approach at 15°.” The sketch below illustrates this definition:

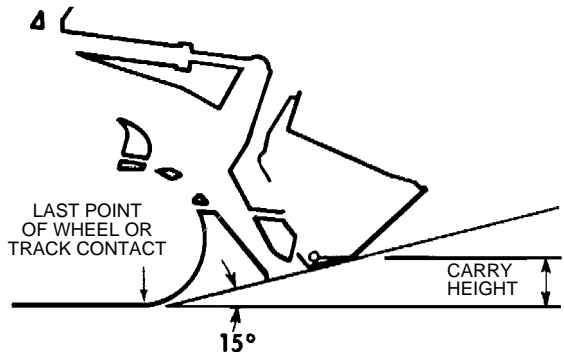

Loader Clearance Circle

SAE J732 JUN92 states that “minimum turning radius (over tire)” and “loader clearance circle” should be given for wheel loaders. Both are given on Caterpillar specification sheets, including loader clearance circles for all available buckets for each machine.

Digging Depth

J732 JUN92 specifies digging depth as “the vertical distance in mm (inches) from the ground line to the bottom of the bucket cutting edge at the lowest position with the bucket cutting edge horizontal.”

SAE BUCKET RATING

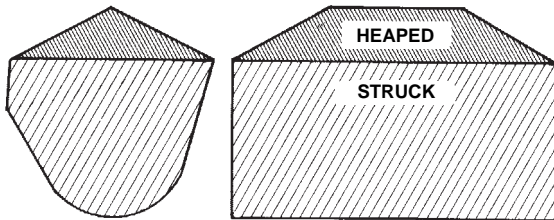

SAE Bucket Capacities

Struck capacity is that volume contained in a bucket after a load is leveled by drawing a straight edge resting on the cutting edge and the back of the bucket.

Heaped capacity is a struck capacity plus that additional material that would heap on the struck load at a 2:1 angle of repose with the struck line parallel to the ground.

SAE J742 (FEB85) specifies that the addition of any auxiliary spill guard to protect against spillage which might injure the operator will not be included in bucket capacity ratings. Buckets with irregular shaped cutting edges (vee edge) the strike plane should be drawn at one-third the distance of the protruding portion of the cutting edge. Caterpillar rock buckets are built with integral see-through rock guards. Caterpillar light material buckets come standard with bolt-on edges. These features which add to actual bucket capacity are included in published ratings.

Dump Height

SAE J732 JUN92 specifies that dump height is the vertical distance from the ground to the lowest point of the cutting edge with the bucket hinge pin at maximum height and the bucket at a 45° dump angle. Dump angle is the angle in degrees that the longest flat section of the inside bottom of the bucket will rotate below horizontal.

SELECTING A MACHINE

Steps in selecting the proper size loader:

1. Determine production required or desired.
2. Determine loader cycle time and cycles per hour.
A machine size must be assumed to select a basic cycle time.

3. Determine required payload per cycle in loose cubic yards and pounds (meters and kilograms).
4. Determine bucket size needed.
5. Make machine selection using bucket size and payload as criteria to meet production requirements.
6. Compare the loader cycle time used in calculations to the cycle time of the machine selected. If there is a difference, rework the process beginning at step 2.

1. Production Required

The production required of a wheel or track loader should be slightly greater than the production capability of the other critical units in the earth or material moving system. For example, if a hopper can handle 300 tons per hour, a loader capable of slightly more than 300 tons should be used. Required production should be carefully calculated so the proper machine and bucket selections are made.

2. Loader Cycle Times

When hauling loose granular material on a hard smooth operating surface, a .45-.55 minute basic cycle time is considered reasonable for Caterpillar articulated loaders with a competent operator. This includes load, dump, four reversals of direction, full cycle of hydraulics and minimum travel.

Material type, pile height, and other factors may improve or reduce production, and should be added to or subtracted from the basic cycle time when applicable.

When hauls are involved, obtain the haul and return portion of the cycle from the estimated travel chart (this section). Add the haul and return times to the estimated basic cycle time to obtain total cycle time.

CYCLE TIME FACTORS

A basic cycle time (Load, Dump, Maneuver) of .45-.55 minutes is average for an articulated loader [the basic cycle for large loaders, 3 m³ (4 yd³) and up, can be slightly longer], but variations can be anticipated in the field. The following values for many variable elements are based on normal operations. Adding or subtracting any of the variable times will give the total basic cycle time.

Wheel Loaders

Machine Selection

- Truck Loading
- Bucket Fill Factors

*Minutes added (+)
or Subtracted (-)
From Basic Cycle*

<i>Machine</i>	
— Material handler	-.05
<i>Materials</i>	
— Mixed	+.02
— Up to 3 mm (1/8 in)	+.02
— 3 mm (1/8 in) to 20 mm (3/4 in)	-.02
— 20 mm (3/4 in) to 150 mm (6 in)00
— 150 mm (6 in) and over	+.03 and Up
— Bank or broken	+.04 and Up

<i>Pile</i>	
— Conveyor or Dozer piled 3 m (10 ft) and up00
— Conveyor or Dozer piled 3 m (10 ft) or less	+.01
— Dumped by truck	+.02

<i>Miscellaneous</i>	
— Common ownership of trucks and loaders	Up to -.04
— Independently owned trucks	Up to +.04
— Constant operation	Up to -.04
— Inconsistent operation	Up to +.04
— Small target	Up to +.04
— Fragile target	Up to +.05

Using actual job conditions and the above factors, total cycle time can be estimated. Convert total cycle time to cycles per hour.

$$\text{Cycles per hour at 100\% Efficiency} = \frac{60 \text{ min}}{\text{Total Cycle Time in Minutes}}$$

Job efficiency is an important factor in machine selection. Efficiency is the actual number of minutes worked during an hour. Job efficiency accounts for bathroom breaks and other work interruptions.

Cycles per hour at 50 minutes per hour (83% efficiency)	=	Cycles per hour at 100% efficiency	×	50 min actual work time 60 min hour
--	---	--	---	--

TRUCK LOADING

<i>Average loader cycle times</i>	
914G-962G	0.45-0.50
966F Series II-980G	0.50-0.55
988F-990	0.55-0.60
992G-994	0.60-0.70

3. Required Payload Per Cycle

Required payload per cycle is determined by dividing required hourly production by the number of cycles per hour.

4. Bucket Selection

After required payload per cycle has been calculated, the payload should be divided by the loose cubic yard (meter) material weight to determine number of loose cubic yards (meters) required per cycle.

The bulk of material handled does not weigh 1800 kg/m³ (3000 lb/yd³), so a reasonable knowledge of material weight is necessary for accurate production estimates. The Tables Section has average weight for certain materials when actual weights are not known.

The percentage of rated capacity a bucket carries in various materials is estimated below. The bucket size required to handle the required volume per cycle is found with the aid of the percentage of rated bucket capacity called "Bucket Fill Factor."

The bucket size needed is determined by dividing loose cubic meters (or yards) required per cycle by the bucket fill factor.

$$\text{Bucket size} = \frac{\text{Volume Required/Cycle}}{\text{Bucket Fill Factor}}$$

BUCKET FILL FACTORS

The following indicates the approximate amounts of material as a percent of rated bucket capacity which will actually be delivered per bucket per cycle. This is known as "Bucket Fill Factor."

<i>Loose Material</i>	<i>Fill factor</i>
Mixed moist aggregates	95-100%
Uniform aggregates up to 3 mm (1/8 in)	95-100
3 mm (1/8 in) to 9 mm (3/8 in)	90-95
12 mm (1/2 in) to 20 mm (3/4 in)	85-90
24 mm (1.0 in) and over	85-90

<i>Blasted Rock</i>	
Well blasted	80-95 %
Average	75-90
Poor	60-75
<i>Other</i>	
Rock dirt mixtures	100-120%
Moist loam	100-110
Soil, boulders, roots	80-100
Cemented materials	85-95

NOTE: Fill factors on wheel loaders are affected by bucket penetration, breakout force, rackback angle, bucket profile and ground engaging tools such as bucket teeth or bolt-on replaceable cutting edges.

Example:

12 mm (1/2 in) material and 3 m³ (4 yd³) bucket.
 .90 × 3 m³ = 2.75 Loose m³ delivered per cycle.
 .90 × 4 yd³ = 3.6 Loose yd³ delivered per cycle.

NOTE: Check the static tipping load on the specific machine to determine if bucket load is in fact a safe operating load.

Bucket Selection

$$\text{Tons Required/Cycle} = \frac{\text{Tons Required/Hour}}{\text{CyclesHour}}$$

$$\frac{\text{Kg (Pounds)}}{\text{Required/Cycle}} = \frac{\text{Tons Required/Cycle}}{\times 907 \text{ kg (2000 lb)}}$$

$$\text{Volume Required/Cycle} = \frac{\text{kg (Pounds)Cycle}}{\text{Material Weight kg/m}^3 \text{ (lb/yd}^3\text{)}}$$

Always select a machine with a greater capacity than the calculated required operating capacity. For most applications, payload above recommended and excessive counterweight can hinder machine performance and reduce dynamic stability and machine life.

For optimum performance in fast cycling situations such as truck loading, operating loads should not exceed the recommended capacity. To provide extra stability, calcium chloride (CaCl₂) ballast may be desired when operating at recommended operating load, see SAE Loader rating pages in this section. For specific stability data and optional tire sizes, see the "Performance Data" pages in this section.

When selecting special application buckets, such as multi-purpose and side dump the additional bucket weight must be deducted from recommended capacity.

Specific circumstances may involve other conditions which would also affect loader capacity. Because of the greatly varied applications and conditions, your Caterpillar dealer should be contacted for guidance.

Example problem:

JOB CONDITIONS

Application	Truck loading
Production Required	450 metric ton (496 Tons) per hour
Material	9 mm (3/8") gravel in 6 m (20 ft) high stockpile
Density	1660 kg/m ³ (2800 lb/yd ³)

Trucks are 6-9 m³ (8-12 yd³) capacity and are owned by three contractors. Loading is constant. Hard level surface for loader maneuvering.

1. **PRODUCTION REQUIRED:** Given
2. **CYCLE TIME:** Assume loader size between 914G and 962G for initial choice of basic cycle.
 (Refer to Cycle Time Factors in this section)

Independent trucks	.04 min
Basic Cycle	.50 min
Material	-.02 min
Independent trucks	+.04 min
Constant operation	-.02 min
Total Cycle	.50 min

NOTE: Load and carry times not required in total cycle.

$$\begin{aligned} \text{Cycles/hr at 83\% efficiency} &= 120 \text{ cycles/hr} \times \frac{50 \text{ min actual work time}}{60 \text{ min per hr}} \\ &= 100 \text{ cycles/hr} \end{aligned}$$

3. **VOLUME REQUIRED PER CYCLE**
 (Density in tons)
 Density in this example was given. When not given, refer to Tables Section to obtain an estimated density for the material being handled.

$$\text{Metric: } \frac{1660 \text{ kg/m}^3}{1000 \text{ kg/ton}} = 1.66 \text{ ton/m}^3$$

$$\text{English: } \frac{2800 \text{ lb/yd}^3}{2000 \text{ lb/ton}} = 1.4 \text{ tons/yd}^3$$

Production Rate Required

$$\text{Metric: } \frac{450 \text{ tons/hr}}{1.66 \text{ tons/m}^3} = 271 \text{ m}^3/\text{hr}$$

$$\text{English: } \frac{496 \text{ tons/hr}}{1.4 \text{ tons/yd}^3} = 354 \text{ yd}^3/\text{hr}$$

Volume Required per Cycle

$$\text{Metric: } \frac{271 \text{ m}^3/\text{hr}}{100 \text{ cycles/hr}} = 2.71 \text{ m}^3/\text{cycle}$$

$$\text{English: } \frac{354 \text{ yd}^3/\text{hr}}{100 \text{ cycles/hr}} = 3.54 \text{ yd}^3/\text{cycle}$$

4. DETERMINE BUCKET SIZE

BUCKET FILL FACTOR

The volume of material required per cycle has been determined. Because of varying material fill factors, buckets do not always carry their rated load, a larger capacity bucket may be needed to carry the volume required. For fill factors, refer to Bucket Fill Factor Chart in this section.

Rated Bucket Capacity Required (Heaped)

$$\frac{2.71 \text{ m}^3/\text{cycle}}{.95 \text{ fill factor}} = 2.85 \text{ m}^3$$

$$\frac{3.54 \text{ yd}^3/\text{cycle}}{.95 \text{ fill factor}} = 3.73 \text{ yd}^3$$

A 2.9 m³ (3.75 yd³) bucket would provide the required capacity.

5. MACHINE SELECTION

The bucket size required and material density lead to the choice of a 950G with a 2.9 m³ (3.75 yd³) General Purpose Bucket (see bucket selection guide pages which follow.)

Finally, SAE payload criteria must be satisfied as follows:

The required operating capacity must not exceed one-half of the full turn static tipping load of the loader as equipped with a specific bucket.

The required operating capacity of the machine is determined by the volume the machine will carry per load times the density.

$$2.9 \text{ m}^3 \times 1660 \text{ kg/m}^3 = 4814 \text{ kg}$$

$$(3.75 \text{ yd}^3 \times 2800 \text{ lb/yd}^3 = 10,500 \text{ lb})$$

One half of full turn static tipping load for the 950G with a 2.9 m³ (3.75 yd³) General Purpose Bucket is 5259 kg (11,591 lb). SAE criteria is satisfied.



An Alternative Method of Machine Selection

Another method of selecting the right Wheel Loader and bucket to meet production requirements is by use of the nomographs on the following pages. The method is quicker and easier than the preceding example because it does not require as many calculations, yet the accuracy is about the same within the normal limits of input data.

Be careful when entering and reading data from the nomographs because some scales increase from bottom to top, while others are the reverse. Do not be overly concerned with the precision as affected by pencil line width or reading to the hundredth of a m³ (yd³). Remember that bucket fill factor, material density and cycle time are at best close estimates.

Example problem:

A Wheel Loader must produce 230 m³ (300 yd³) per hour in a truck loading application. Estimated cycle time is .6 minutes, working 45 minutes per hour. Bucket fill factor is 95% and material density is 1780 kg/m³ (3000 lb/yd³).

Determine bucket size and machine model.

Solution:

At full efficiency, the Wheel Loader will cycle 100 times per hour. Since only an average of 45 minutes are available, only 75 cycles will be completed.

Starting on Scale A at 75 cycles per hour draw a straight line intersecting 230 m³/hr (300 yd³/hr) on Scale B and extending it on to Scale C giving 3 m³/cycle (4 yd³/cycle) required payload. Follow solution steps 1-10.

Production and Machine Selection Nomograph

Wheel Loaders

● To find payload weight and tons per hour

1. Enter required hourly production on Scale B
230 m³/hr (300 yd³/hr).
2. Enter cycles per hour on Scale A (60 ÷ .6 = 100
× .75 = 75 cycles/hr).
3. Connect A thru B to C. This shows a required
payload of 3 m³ (4 yd³) per cycle.
4. Enter estimated bucket fill factor on Scale D
(0.95).
5. Connect C thru Scale D to E for required bucket
size 3 m³ (4 yd³).
6. Transfer cycles per hour Scale A and required
payload Scale C to the following page.

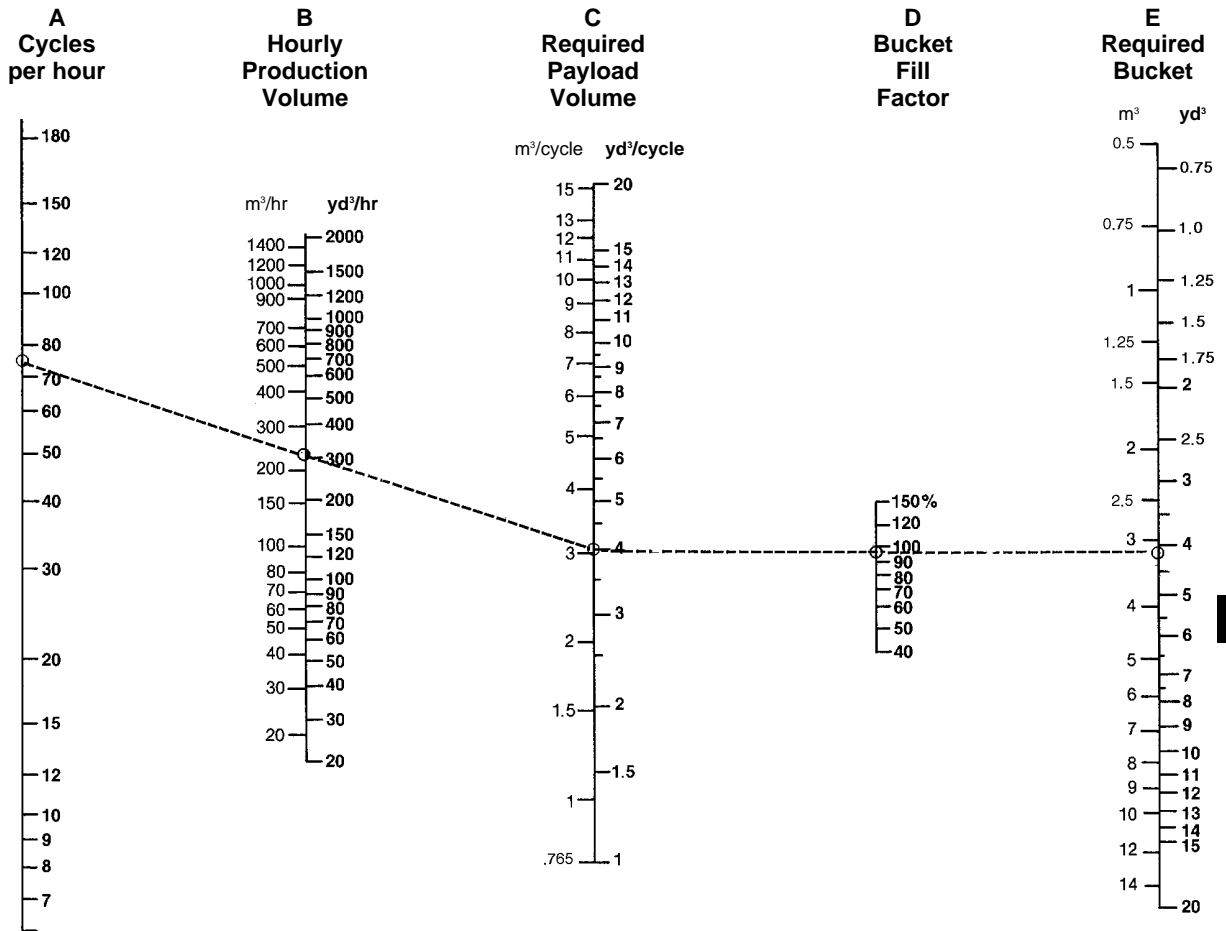

Wheel Loaders

Production and Machine Selection Nomograph

- To find required bucket payload and bucket size

- Enter material density on Scale F 1780 kg/m³ (3000 lb/yd³).
- Connect C thru Scale F to Scale G to give payload weight per cycle 5300 kg (11,500 lb).
- Compare Scale G quantity 5300 kg (11,500 lb) with recommended machine working range listed on the following bucket selection pages.

Operating capacity for the 950G with 3.1 m³ (4 yd³) bucket is dependent on material density (see bucket selection pages that follow).

- For hourly tonnage, draw a straight line from Scale G thru Scale A to Scale I 400 metric tons (450 U.S. tons).

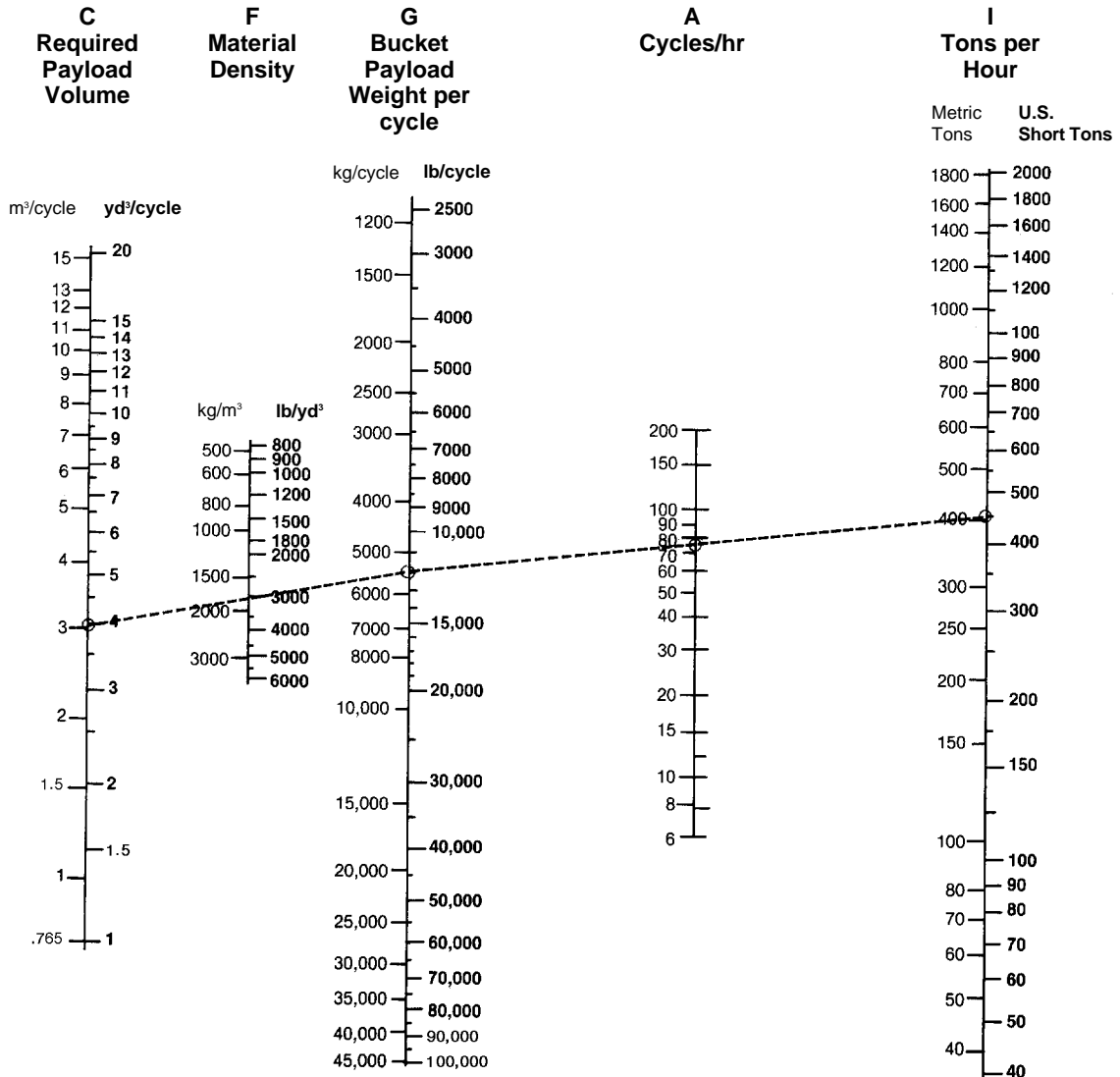

902

Bucket Type	Rated Capacity		Maximum Material Density	
	m ³	yd ³	kg/m ³	lb/yd ³
General Purpose	0.6	0.78	2100	3540
Light Material	1.0	1.31	1230	2070
Stone Sieve	0.6	0.78	2050	3460
Multi-Purpose	0.6	0.78	1900	3200
High Dump	0.6	0.78	2000	3370

906

Bucket Type	Rated Capacity		Maximum Material Density	
	m ³	yd ³	kg/m ³	lb/yd ³
General Purpose	0.8	1.05	1850	3120
Light Material	1.2	1.57	1200	2020
Stone Sieve	0.7	0.92	2000	3370
Multi-Purpose	0.7	0.92	1730	2920
Side Dump	0.7	0.92	1850	3120
High Dump	0.7	0.92	2000	3370

914G

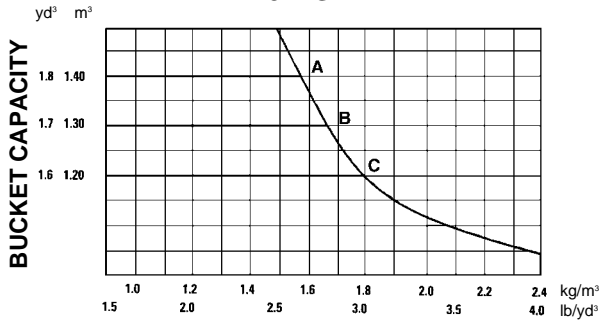

MATERIAL DENSITY (THOUSANDS)

KEY

- A — 1.4 m³ (1.8 yd³) General Purpose Bucket, bolt-on edge
- 1.4 m³ (1.8 yd³) General Purpose Bucket, bolt-on teeth and segments
- B — 1.3 m³ (1.7 yd³) General Purpose Bucket, bolt-on edge
- 1.3 m³ (1.7 yd³) General Purpose Bucket, bolt-on teeth and segments
- 1.3 m³ (1.7 yd³) General Purpose Bucket, flush mounted teeth
- 1.3 m³ (1.7 yd³) General Purpose Bucket, bolt-on teeth
- C — 1.2 m³ (1.6 yd³) General Purpose Bucket, bolt-on teeth

924F

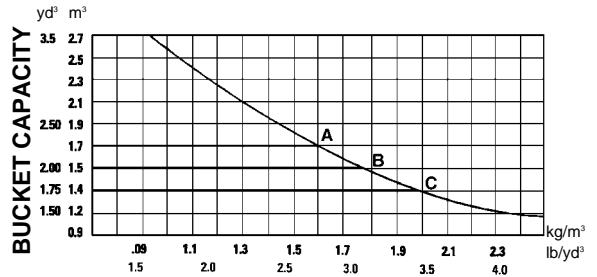

MATERIAL DENSITY (THOUSANDS)

KEY

- A — 1.7 m³ (2.25 yd³) Loose Material Bucket, bolt-on edge
- 1.7 m³ (2.25 yd³) Loose Material Bucket, bolt-on teeth and segments
- B — 1.5 m³ (2.00 yd³) Loose Material Bucket, bolt-on edge
- 1.5 m³ (2.00 yd³) Excavating Bucket, bolt-on edge
- 1.5 m³ (2.00 yd³) Excavating Bucket, bolt-on teeth and segments
- C — 1.4 m³ (1.75 yd³) Excavating Bucket, bolt-on teeth

928G

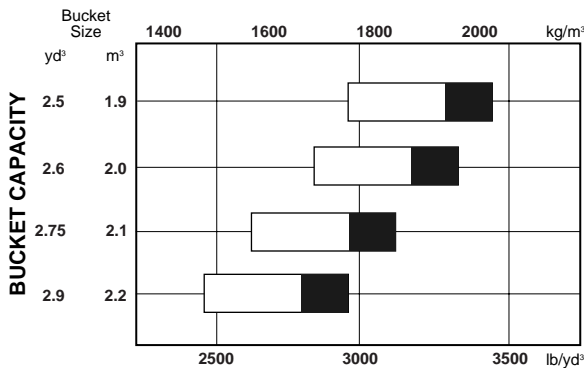

MATERIAL DENSITY

% = Bucket Fill Factor

938G

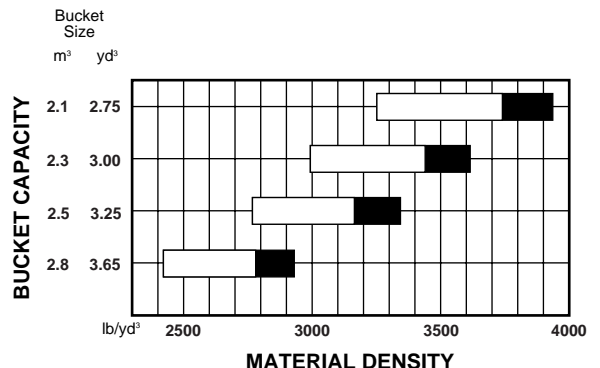

MATERIAL DENSITY

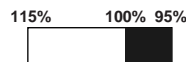

950G

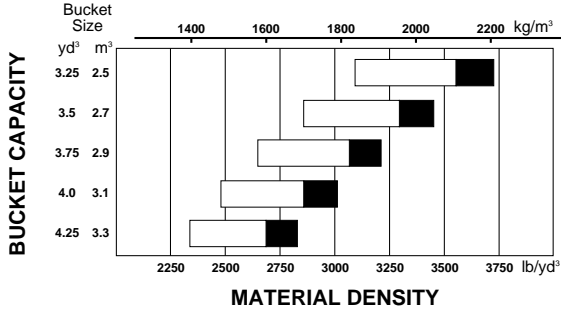

962G

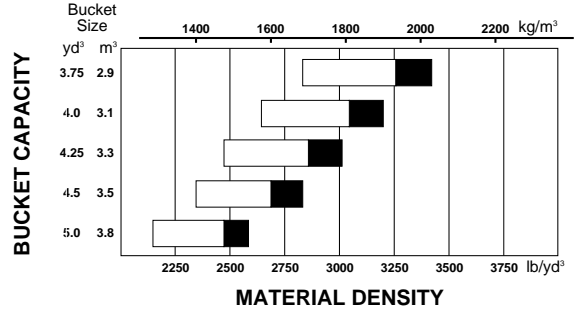

966F Series II

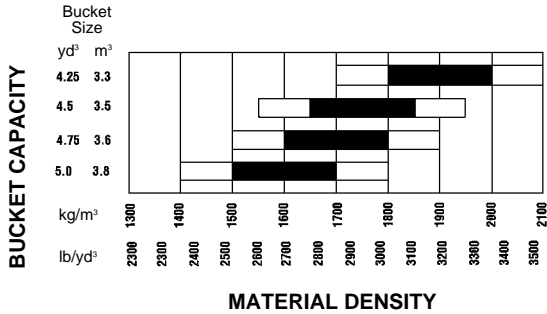

970F

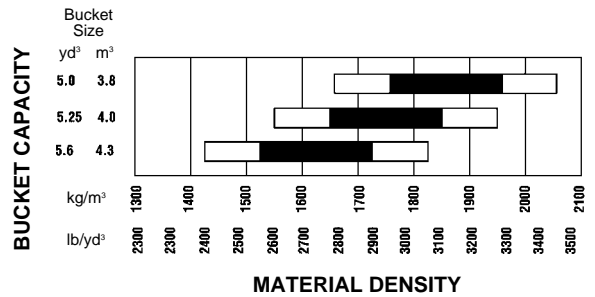

980G

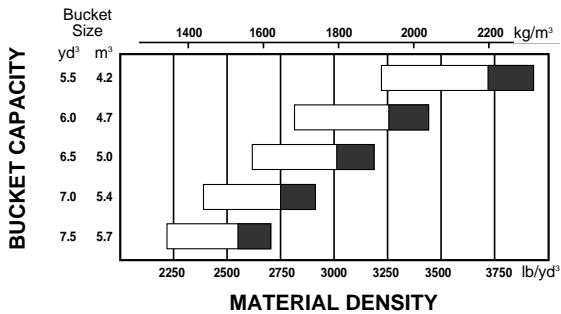

980G High Lift

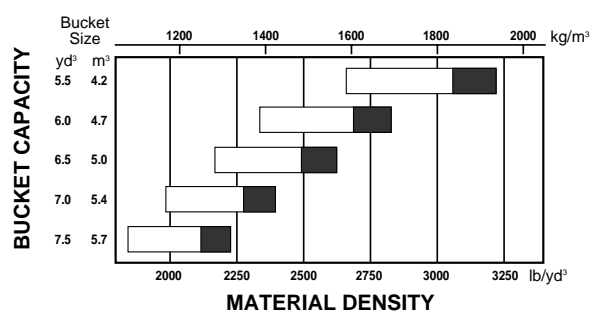

115% 100% 95%
 % = Bucket Fill Factor

- 988F Series II
- 988F Series II HL
- 990
- 992G

988F Series II

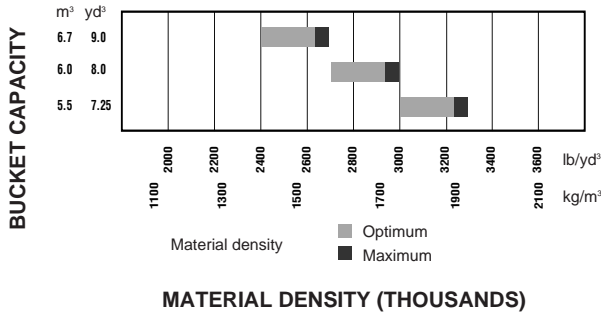

988F Series II High Lift

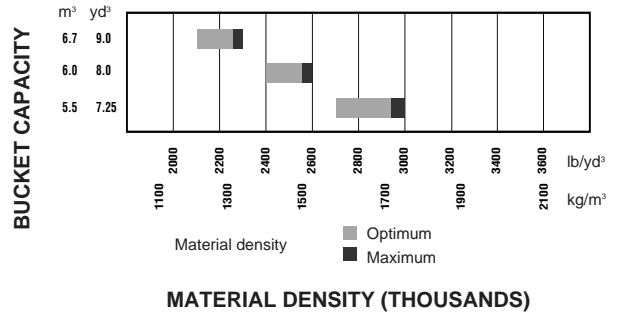

NOTE: Percentages represent bucket fill factors

NOTE: Percentages represent bucket fill factors

990 Series II

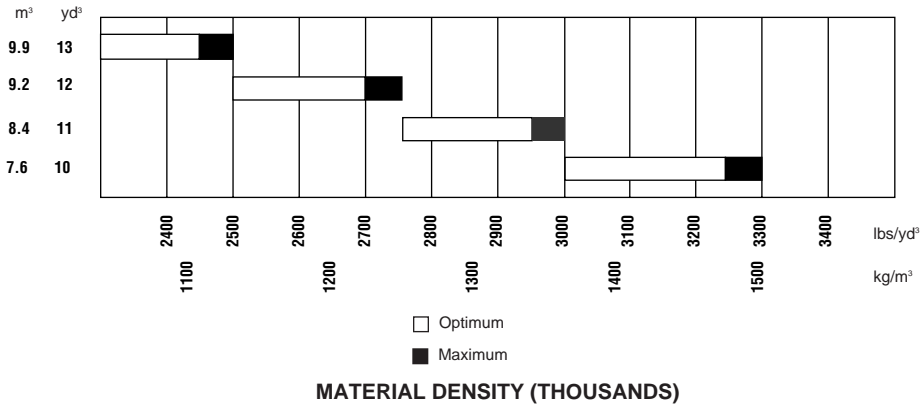

MATERIAL DENSITY (THOUSANDS)

992G

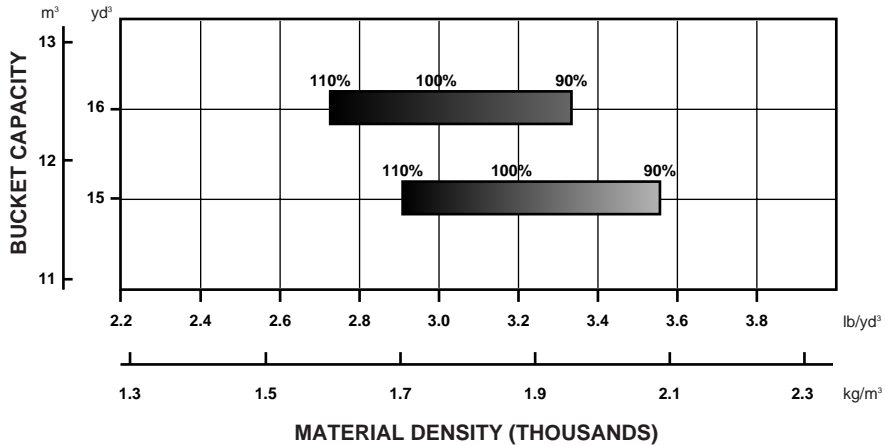

NOTE: Percentages represent bucket fill factors

994

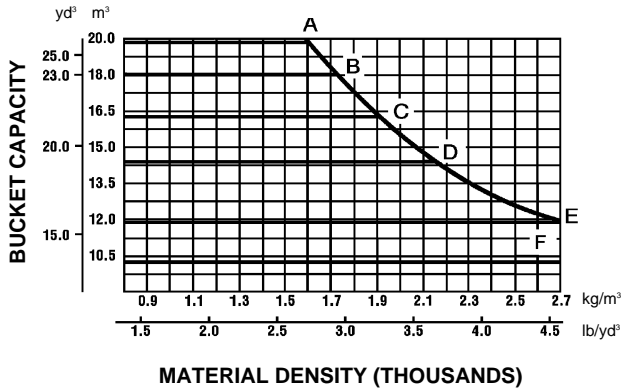

994 High Lift

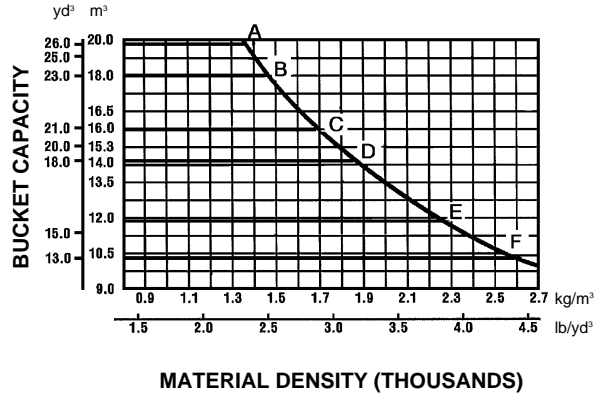

KEY

- A — 20.0 m³ (26.0 yd³) Rock Bucket Spade edge with teeth
- B — 18.0 m³ (23.0 yd³) Rock Bucket Spade edge with teeth
- C — 16.0 m³ (21.0 yd³) Rock Bucket Spade edge with teeth and segments
- D — 14.0 m³ (18.0 yd³) Rock Bucket Spade edge with teeth and segments
- E — 10.0 m³ (13.0 yd³) General Purpose Bucket Spade edge with teeth

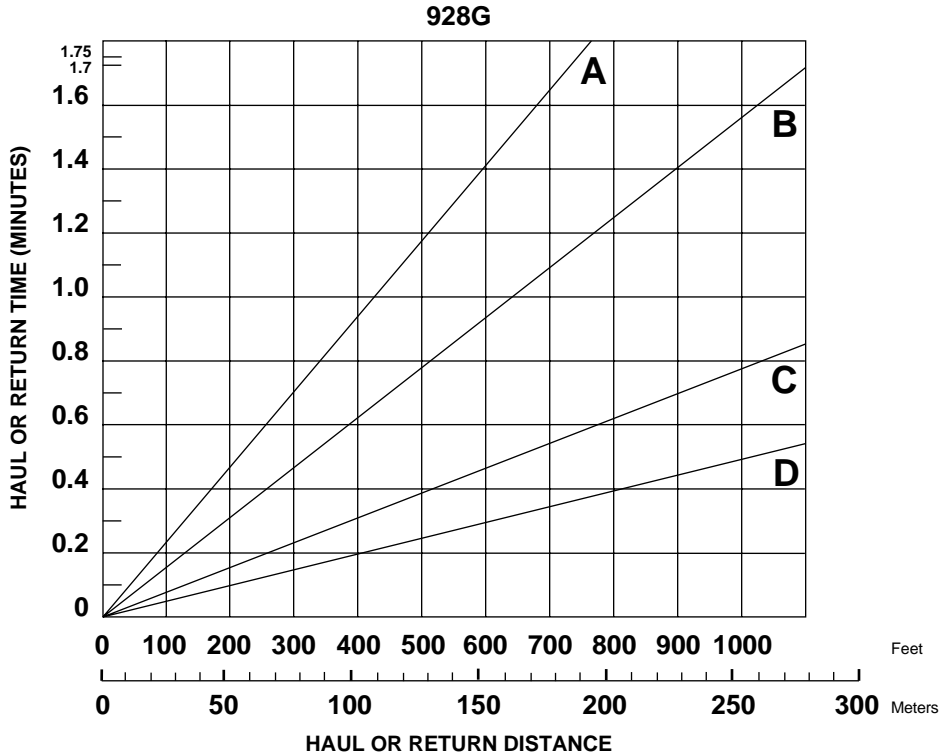

KEY

- A — 1st Forward and Reverse Speed
- B — 2nd Forward and Reverse Speed
- C — 3rd Forward and Reverse Speed
- D — 4th Forward Speed

NOTE: Loader maneuver, load and dump time must be added to travel time. 4th gear curve not indicated; primarily used for transporting machine.

Wheel Loaders

Travel Time — Loaded

- 938G
- 20.5R-25 Tires

938G TRAVEL TIME — LOADED

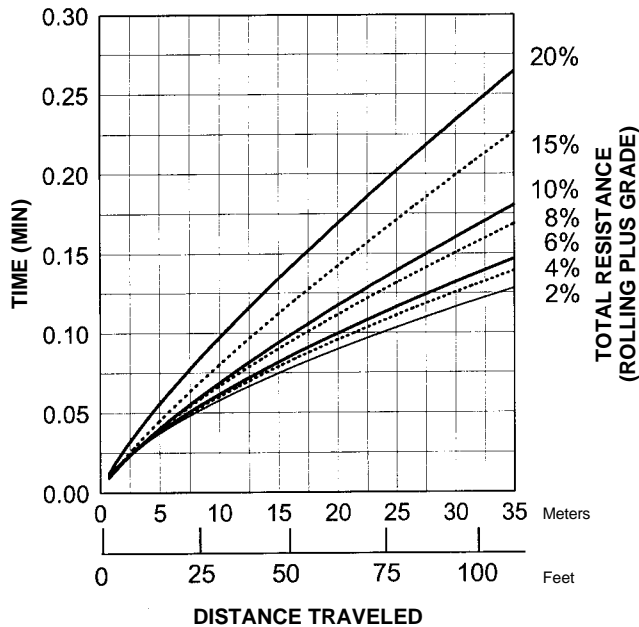
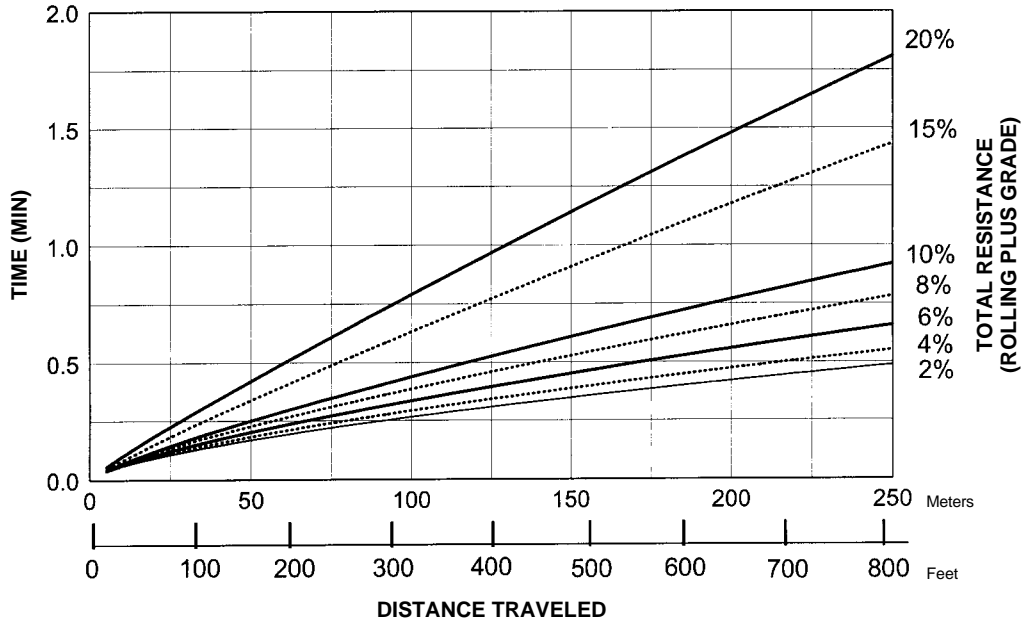

NOTE: Curves assume use of highest operating speed attainable: 4th gear for 2%-6% TR, 3rd gear for 8%-10% TR, 2nd gear for 15% TR and 1st gear for 20% TR.

In load and carry applications it is important to consult the tire manufacturer on Ton-MPH ratings and pressure recommendations.

Travel Time — Empty
 ● 938G
 ● 20.5R-25 Tires

938G TRAVEL TIME — EMPTY

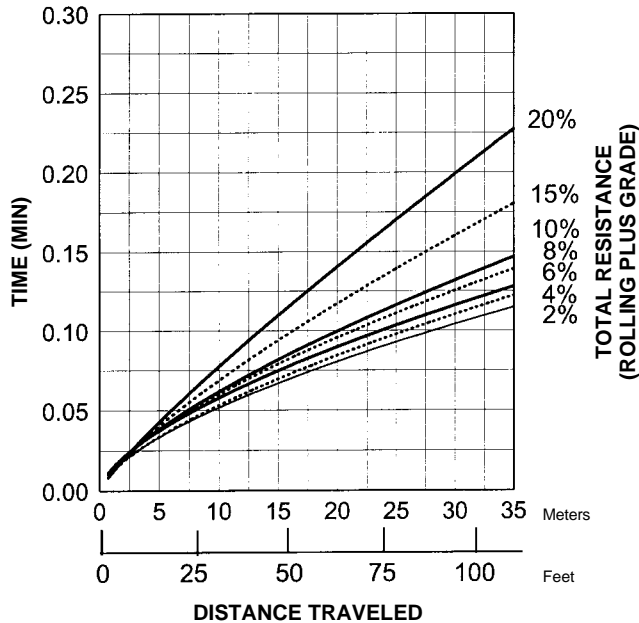
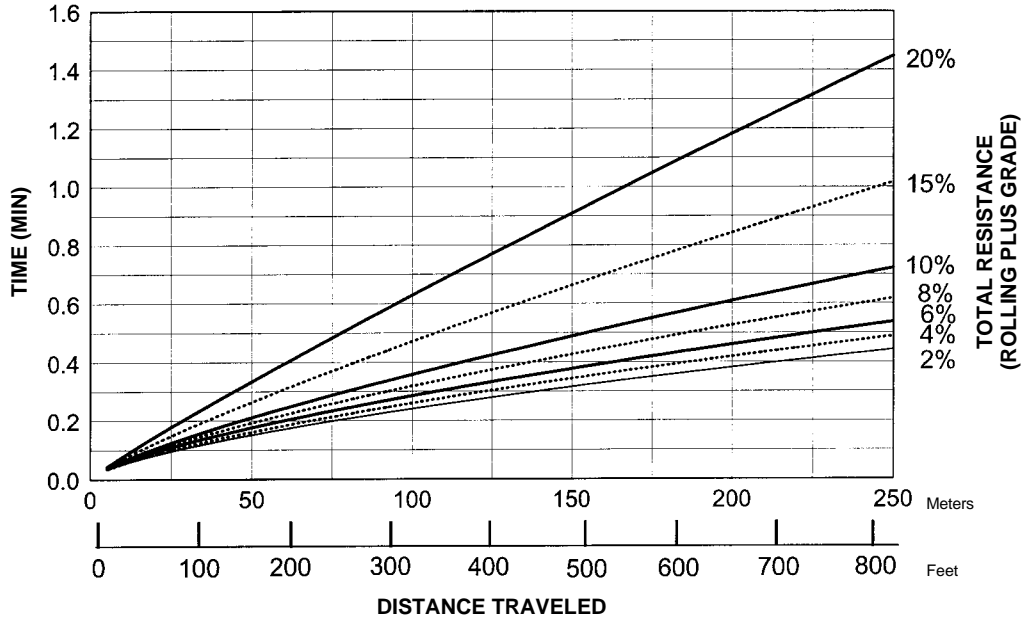

NOTE: Curves assume use of highest operating speed attainable: 4th gear for 2%-6% TR, 3rd gear for 8%-10% TR, 2nd gear for 15% TR and 1st gear for 20% TR.

In load and carry applications it is important to consult the tire manufacturer on Ton-MPH ratings and pressure recommendations.

Wheel Loaders

Travel Time — Loaded

- 950G
- 23.50-R25 Tires

950G TRAVEL TIME — LOADED

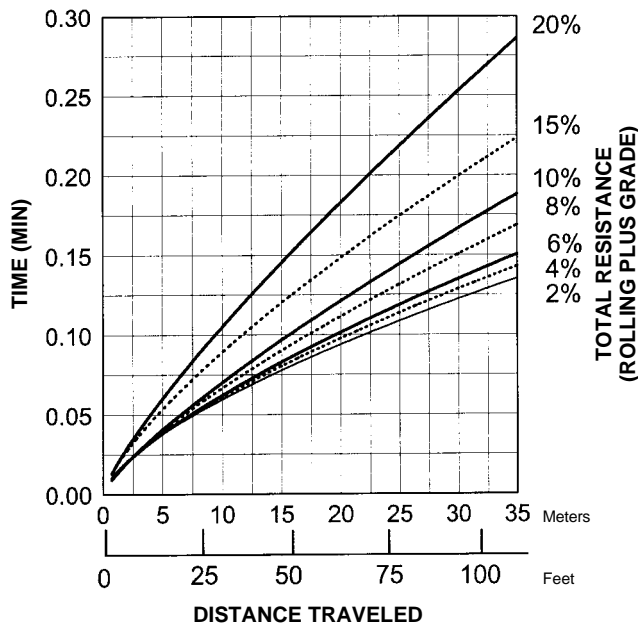
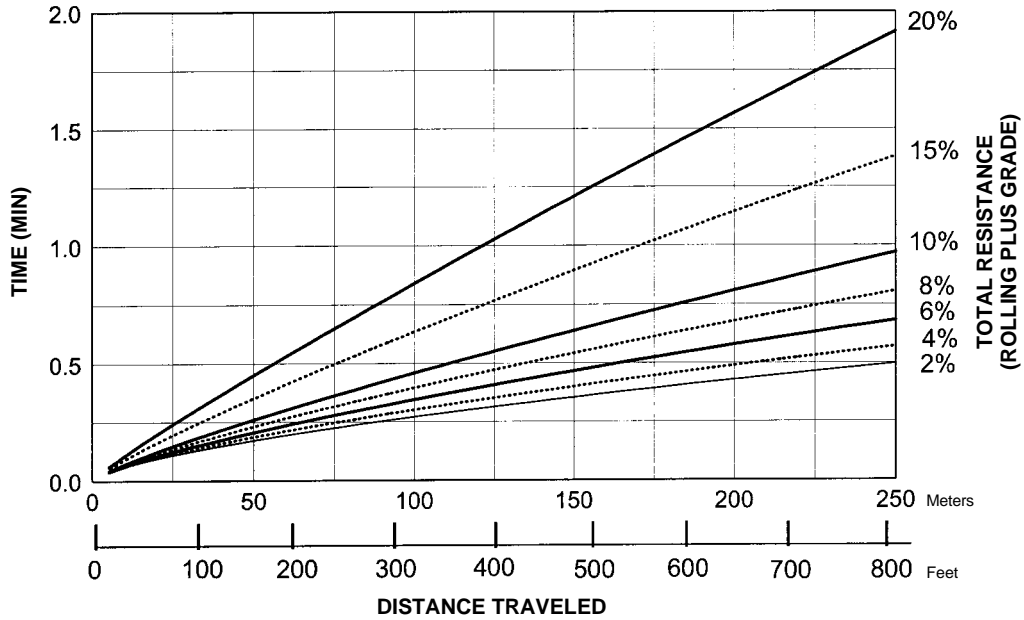

NOTE: Curves assume use of highest operating speed attainable: 4th gear for 2%-6% TR, 3rd gear for 8%-10% TR, 2nd gear for 15% TR and 1st gear for 20% TR.

In load and carry applications it is important to consult the tire manufacturer on Ton-MPH ratings and pressure recommendations.

Travel Time — Empty
● 950G
● 23.50-R25 Tires

950G TRAVEL TIME — EMPTY

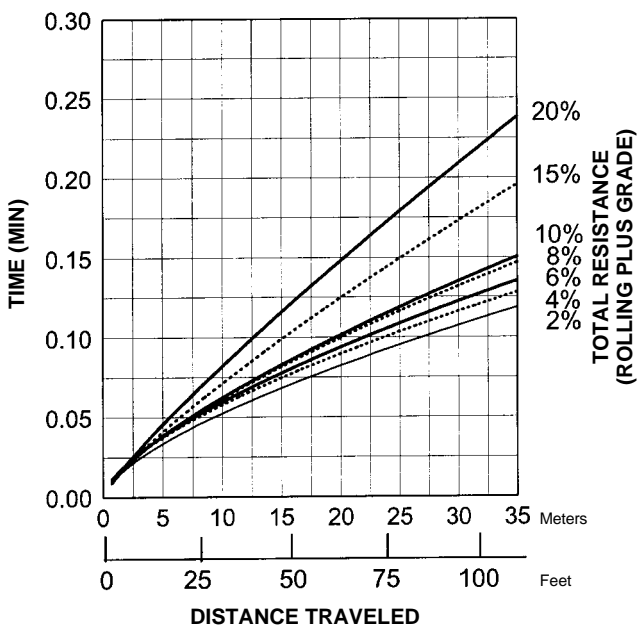
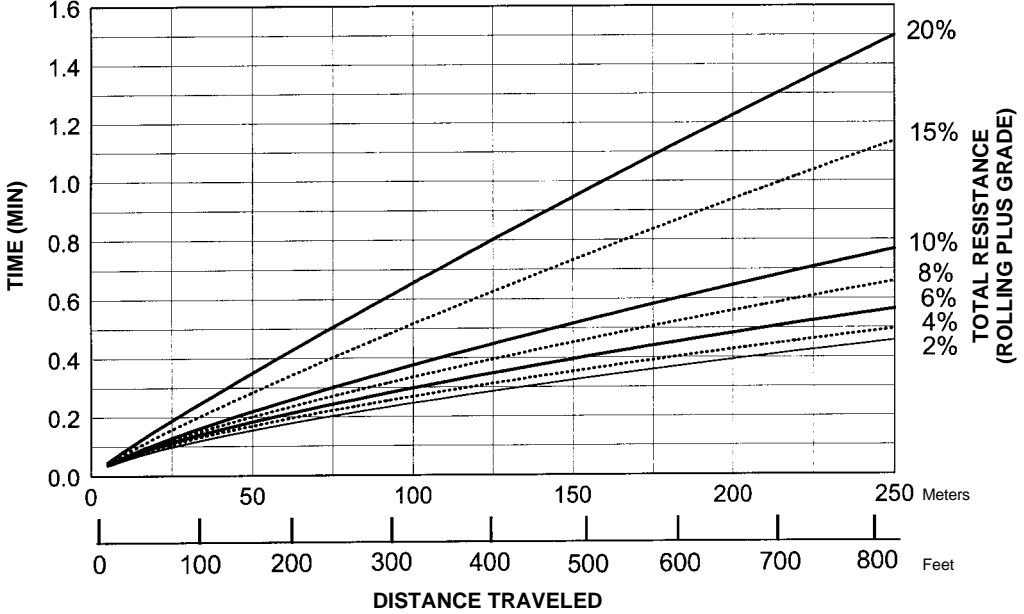

NOTE: Curves assume use of highest operating speed attainable: 4th gear for 2%-6% TR, 3rd gear for 8%-10% TR, 2nd gear for 15% TR and 1st gear for 20% TR.

In load and carry applications it is important to consult the tire manufacturer on Ton-MPH ratings and pressure recommendations.

Wheel Loaders

Travel Time — Loaded

- 962G
- 23.5-R25 Tires

962G TRAVEL TIME — LOADED

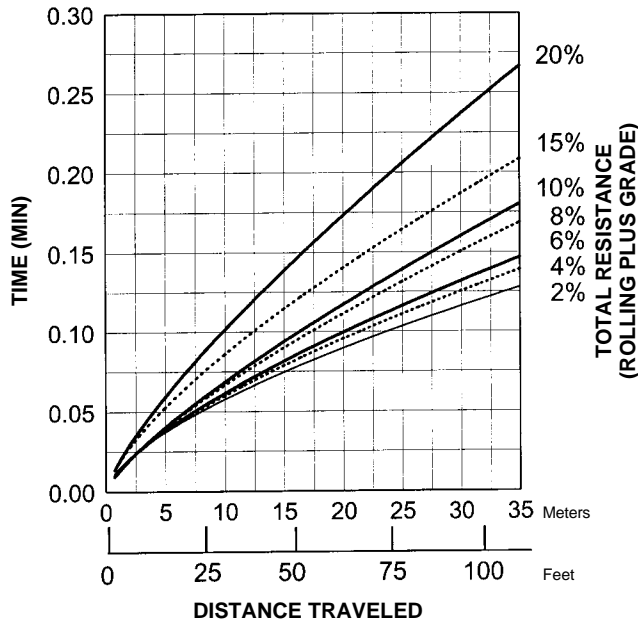
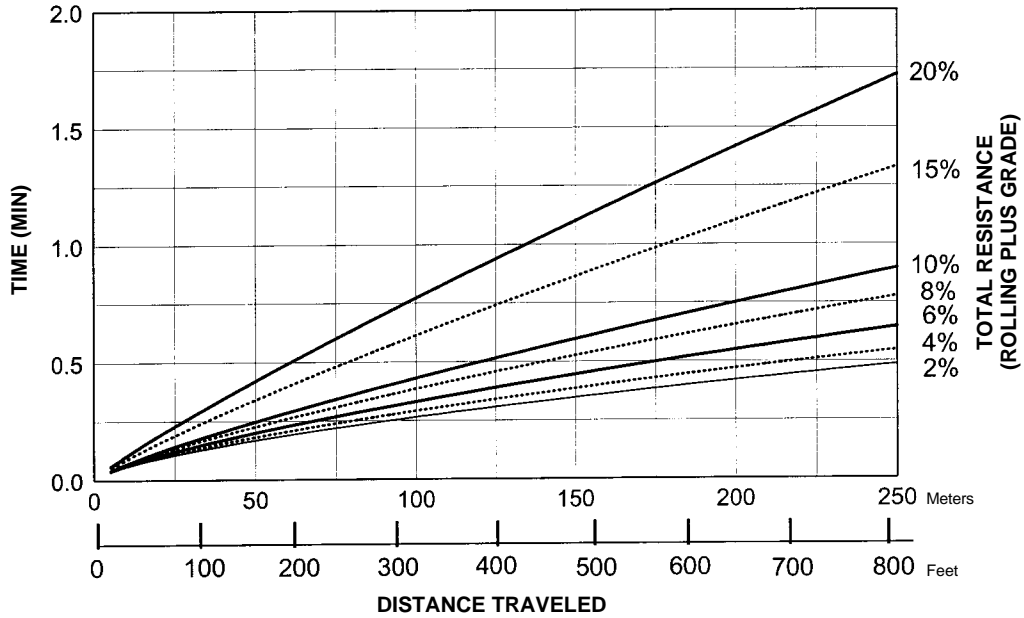

NOTE: Curves assume use of highest operating speed attainable: 4th gear for 2%-6% TR, 3rd gear for 8%-10% TR, 2nd gear for 15% TR and 1st gear for 20% TR.

In load and carry applications it is important to consult the tire manufacturer on Ton-MPH ratings and pressure recommendations.

Travel Time — Empty
 ● 962G
 ● 23.5-R25 Tires

Wheel Loaders

962G TRAVEL TIME — EMPTY

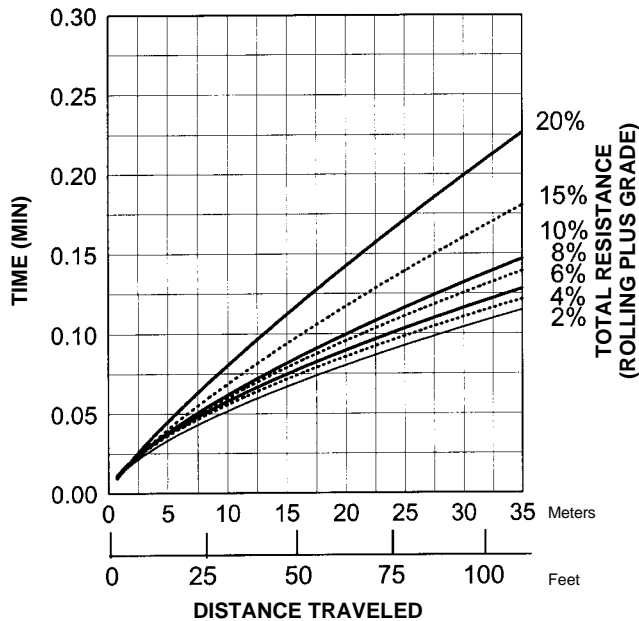
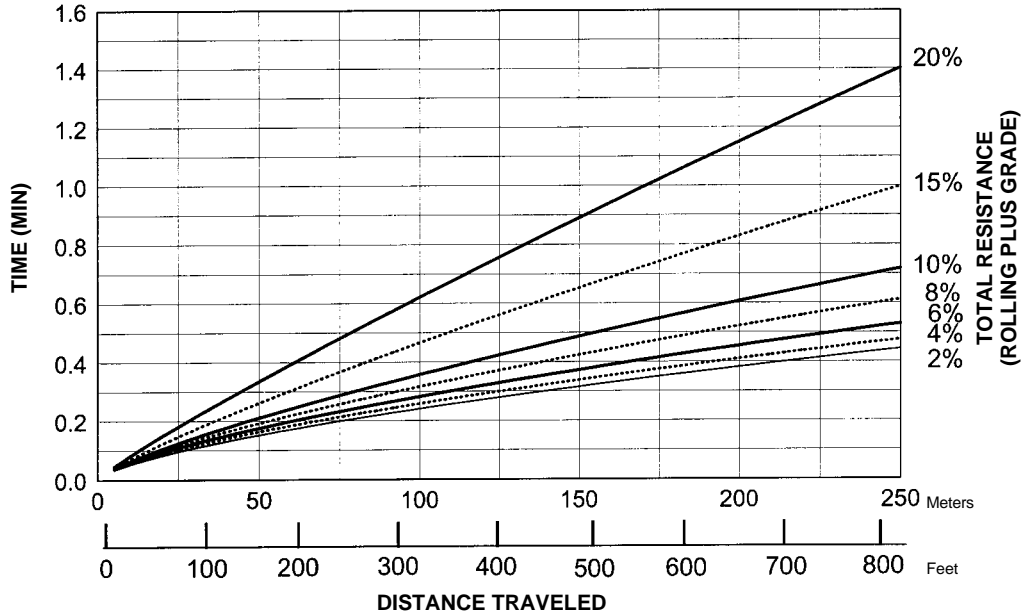

NOTE: Curves assume use of highest operating speed attainable: 4th gear for 2%-6% TR, 3rd gear for 8%-10% TR, 2nd gear for 15% TR and 1st gear for 20% TR.

In load and carry applications it is important to consult the tire manufacturer on Ton-MPH ratings and pressure recommendations.

Wheel Loaders

Travel Time — Loaded

- 966F Series II
- 26.5-25 Tires

966F SERIES II TRAVEL TIME — LOADED

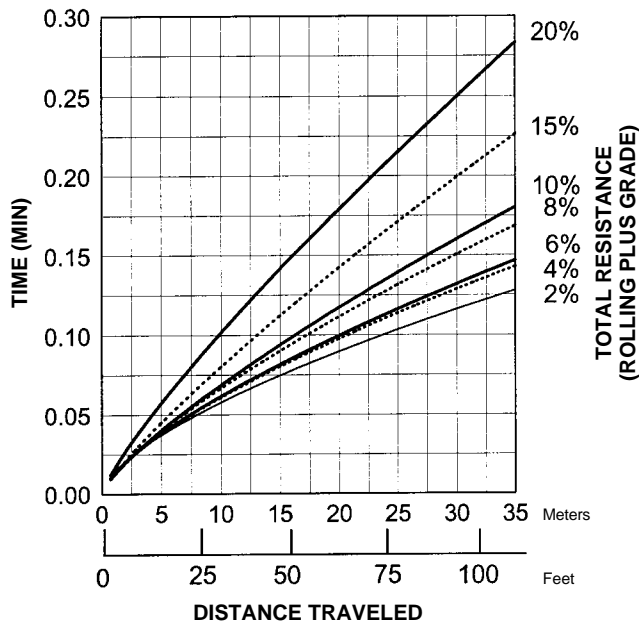
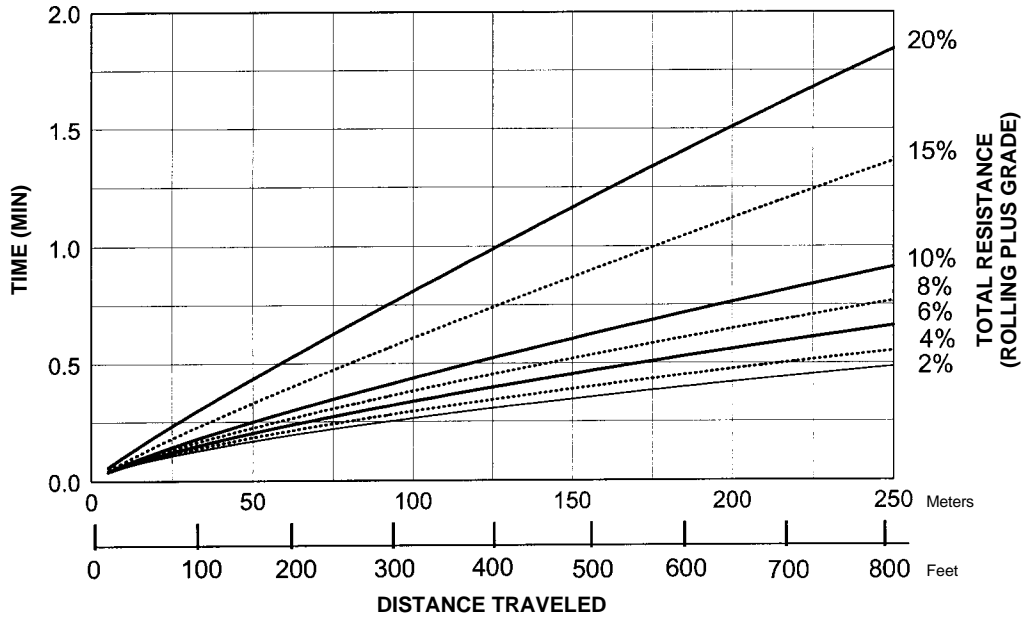

NOTE: Curves assume use of highest operating speed attainable: 4th gear for 2%-6% TR, 3rd gear for 8%-10% TR, 2nd gear for 15% TR and 1st gear for 20% TR.

In load and carry applications it is important to consult the tire manufacturer on Ton-MPH ratings and pressure recommendations.

Travel Time — Empty
● 966F Series II
● 26.5-25 Tires

966F SERIES II TRAVEL TIME — EMPTY

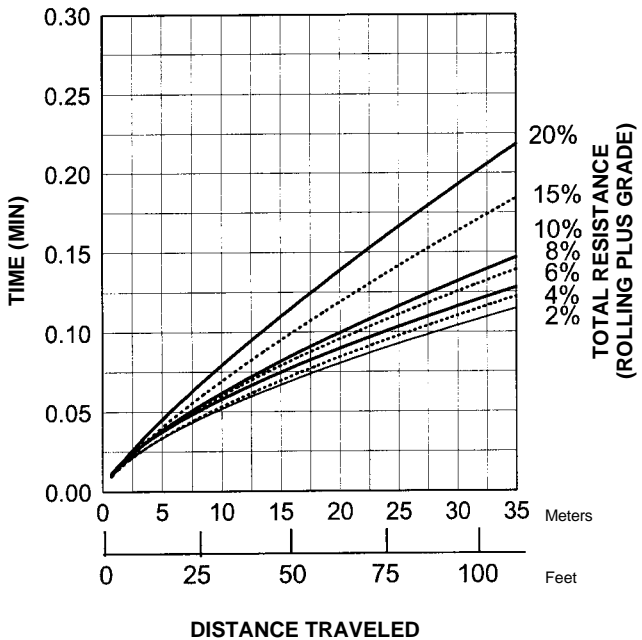
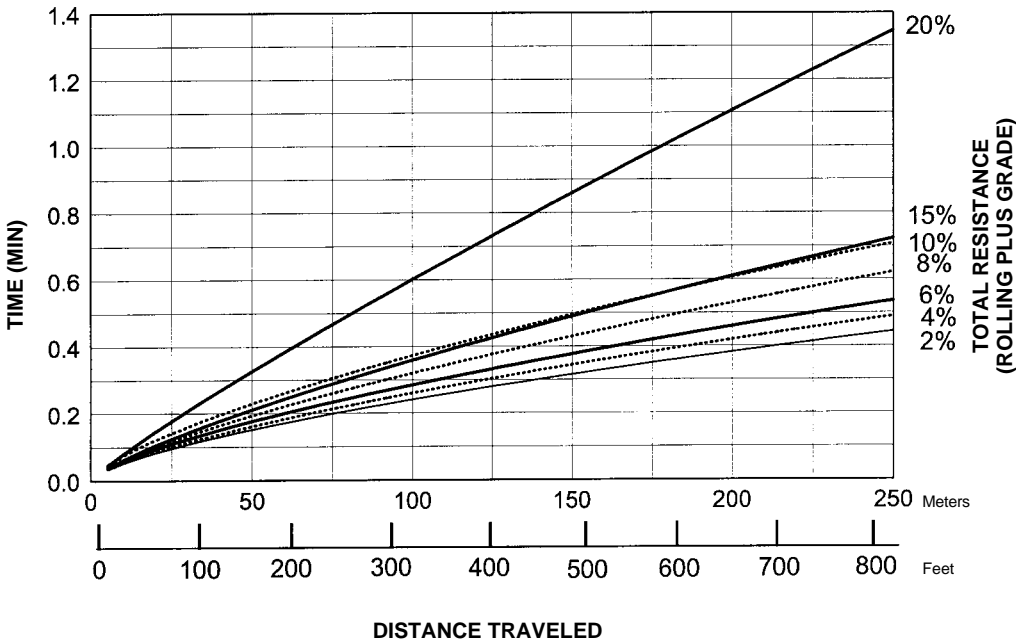

NOTE: Curves assume use of highest operating speed attainable: 4th gear for 2%-6% TR, 3rd gear for 8%-10% TR, 2nd gear for 15% TR and 1st gear for 20% TR.

In load and carry applications it is important to consult the tire manufacturer on Ton-MPH ratings and pressure recommendations.

Wheel Loaders

- Travel Time — Loaded
- 970F (Material Handler)
- 26.5-25 Tires

970F MATERIAL HANDLER TRAVEL TIME — LOADED

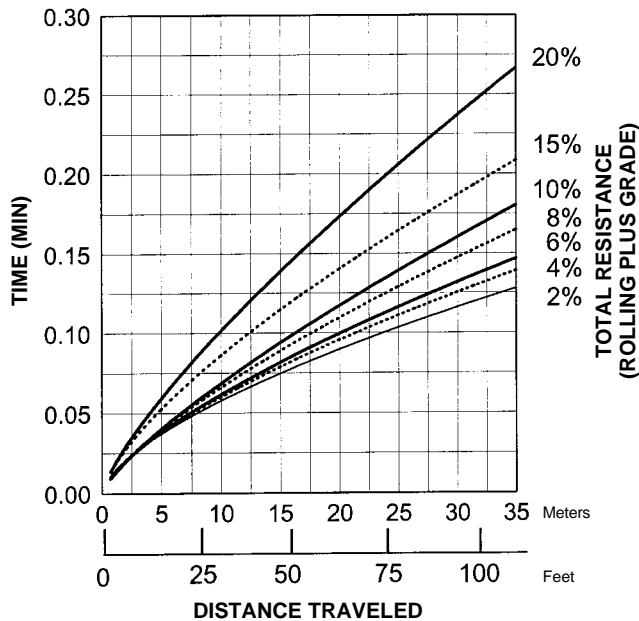
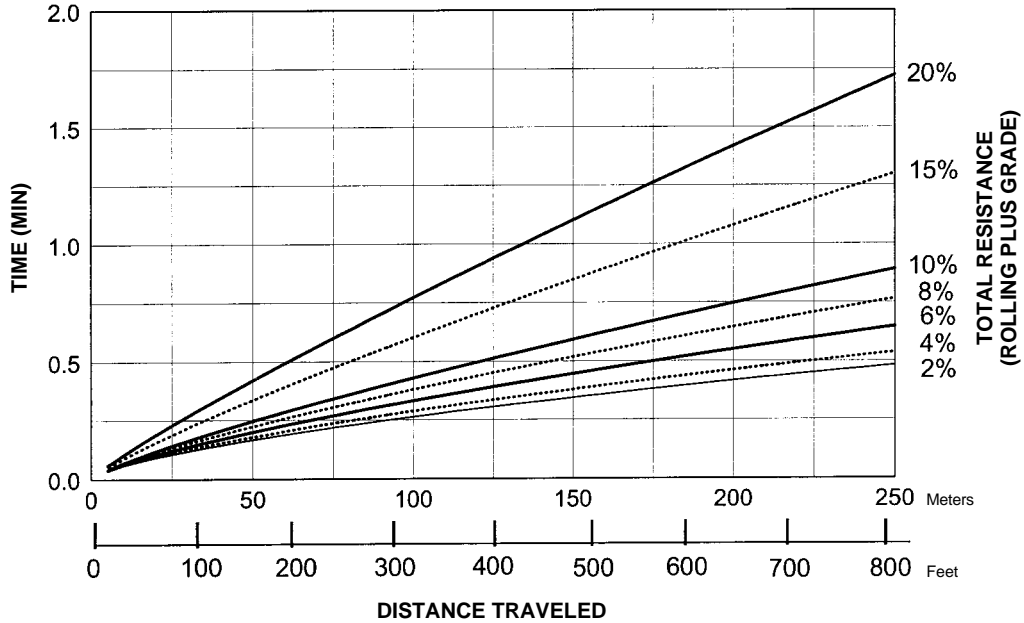

NOTE: Curves assume use of highest operating speed attainable: 4th gear for 2%-6% TR, 3rd gear for 8%-10% TR, 2nd gear for 15% TR and 1st gear for 20% TR.

In load and carry applications it is important to consult the tire manufacturer on Ton-MPH ratings and pressure recommendations.

- Travel Time — Empty
- 970F (Material Handler)
- 26.5-25 Tires

970F MATERIAL HANDLER TRAVEL TIME — EMPTY

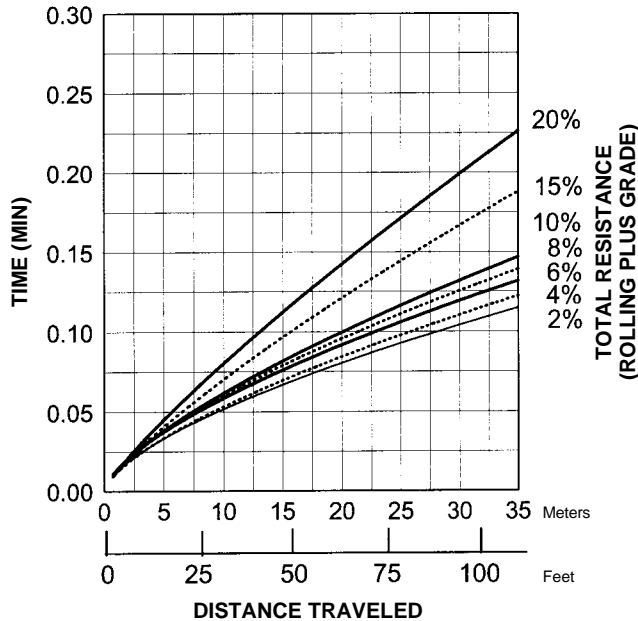
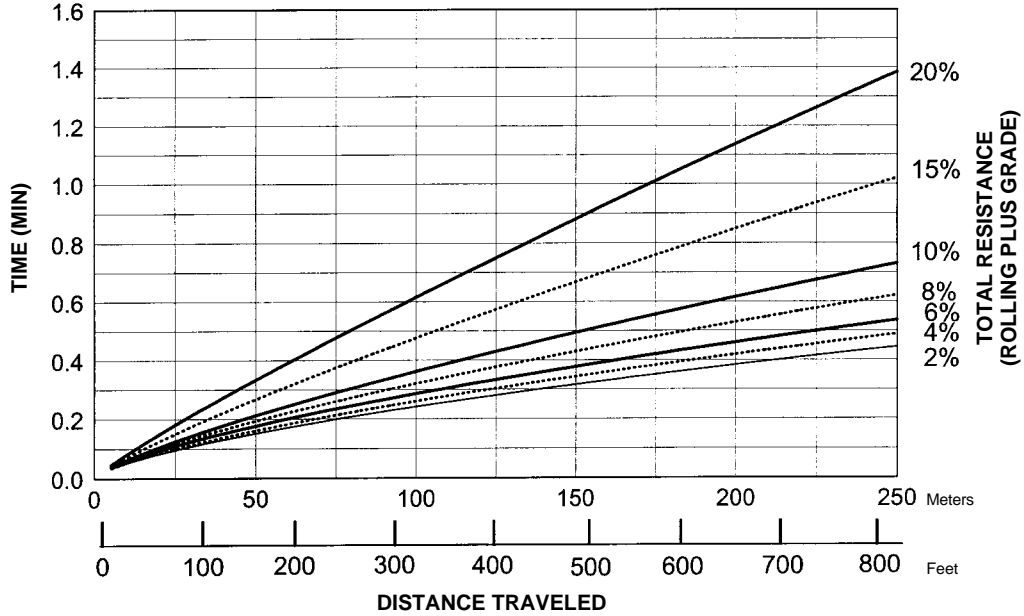

NOTE: Curves assume use of highest operating speed attainable: 4th gear for 2%-6% TR, 3rd gear for 8%-10% TR, 2nd gear for 15% TR and 1st gear for 20% TR.

In load and carry applications it is important to consult the tire manufacturer on Ton-MPH ratings and pressure recommendations.

Wheel Loaders

Travel Time — Loaded

- 980G
- 29.5-25 Tires

980G TRAVEL TIME — LOADED

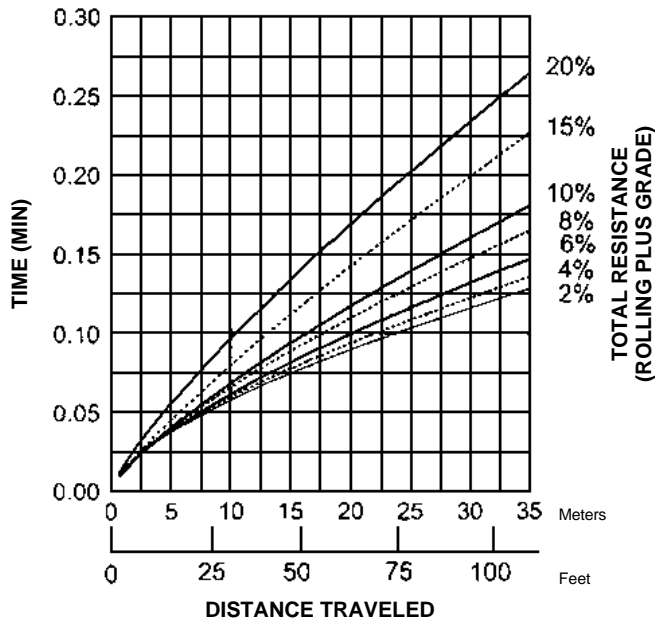
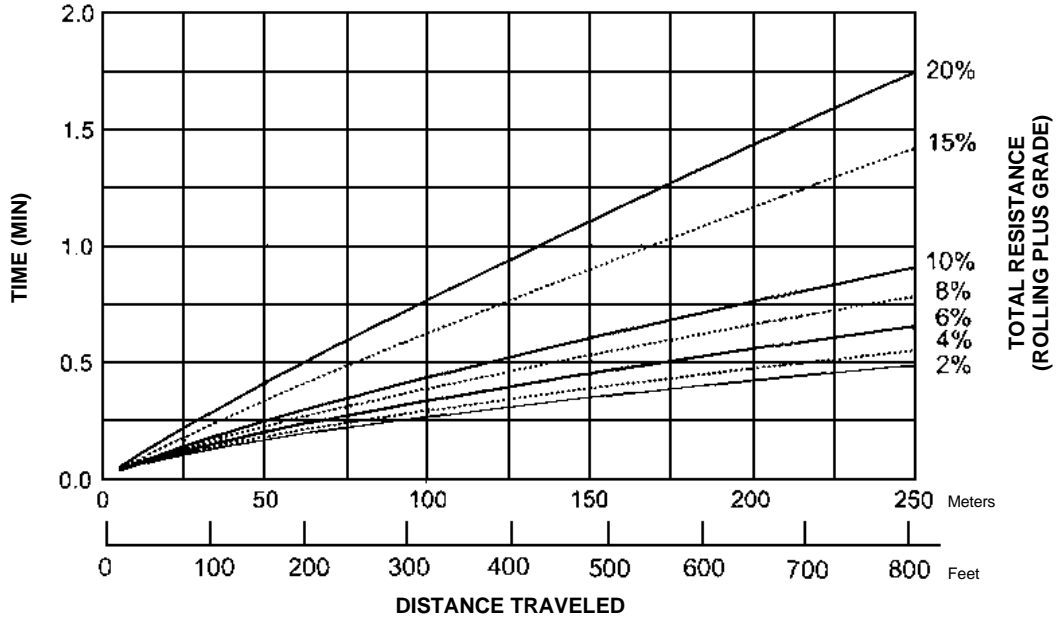

NOTE: Curves assume use of highest operating speed attainable: 4th gear for 2%-6% TR, 3rd gear for 8%-10% TR, 2nd gear for 15% TR and 1st gear for 20% TR.

In load and carry applications it is important to consult the tire manufacturer on Ton-MPH ratings and pressure recommendations.

Travel Time — Empty
 ● 980G
 ● 29.5-25 Tires

Wheel Loaders

980G TRAVEL TIME — EMPTY

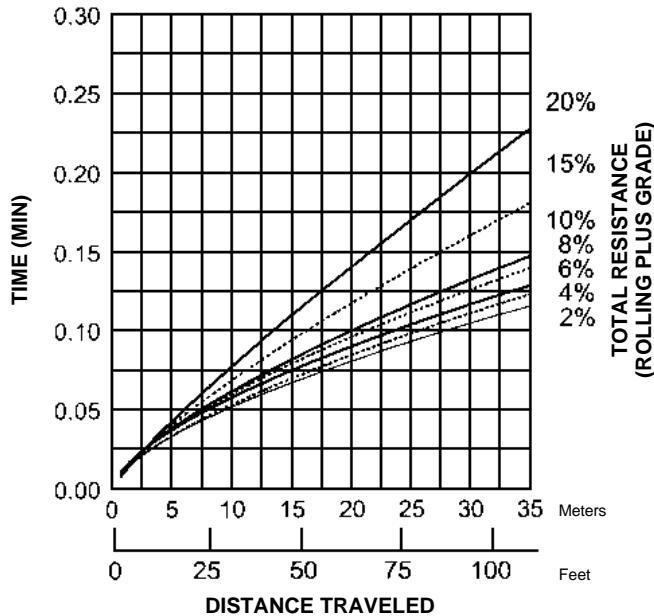
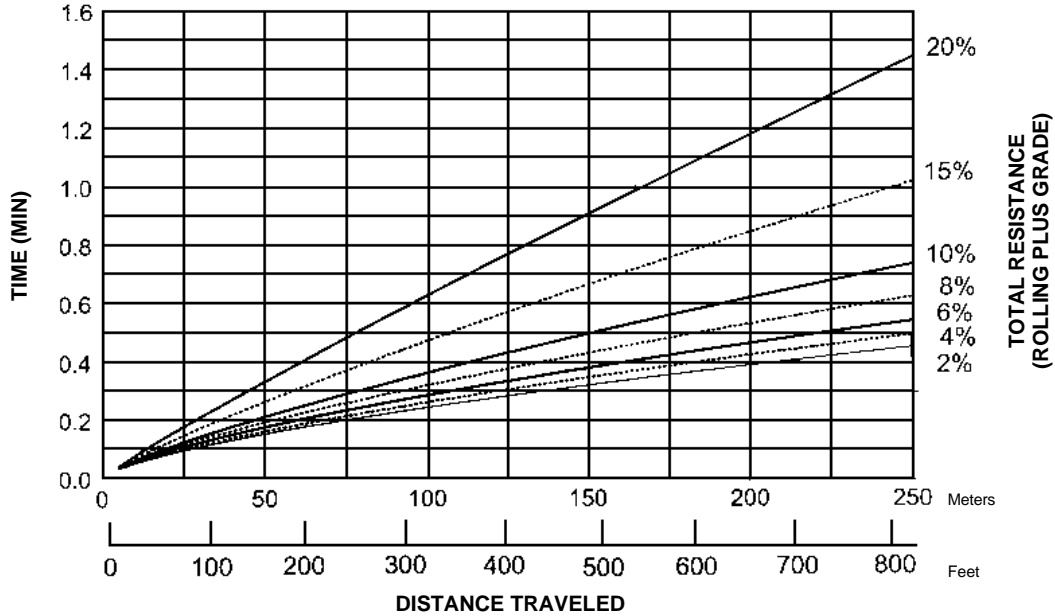

NOTE: Curves assume use of highest operating speed attainable: 4th gear for 2%-6% TR, 3rd gear for 8%-10% TR, 2nd gear for 15% TR and 1st gear for 20% TR.

In load and carry applications it is important to consult the tire manufacturer on Ton-MPH ratings and pressure recommendations.

Wheel Loaders

Travel Time — Loaded

- 988F Series II
- 35/65-33 Tires

988F SERIES II TRAVEL TIME — LOADED

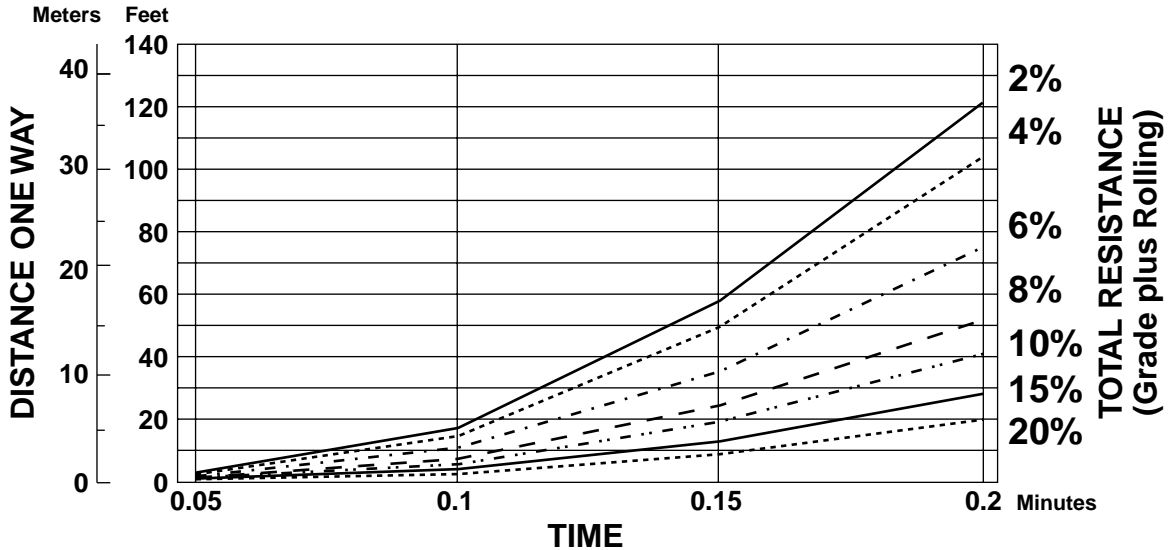
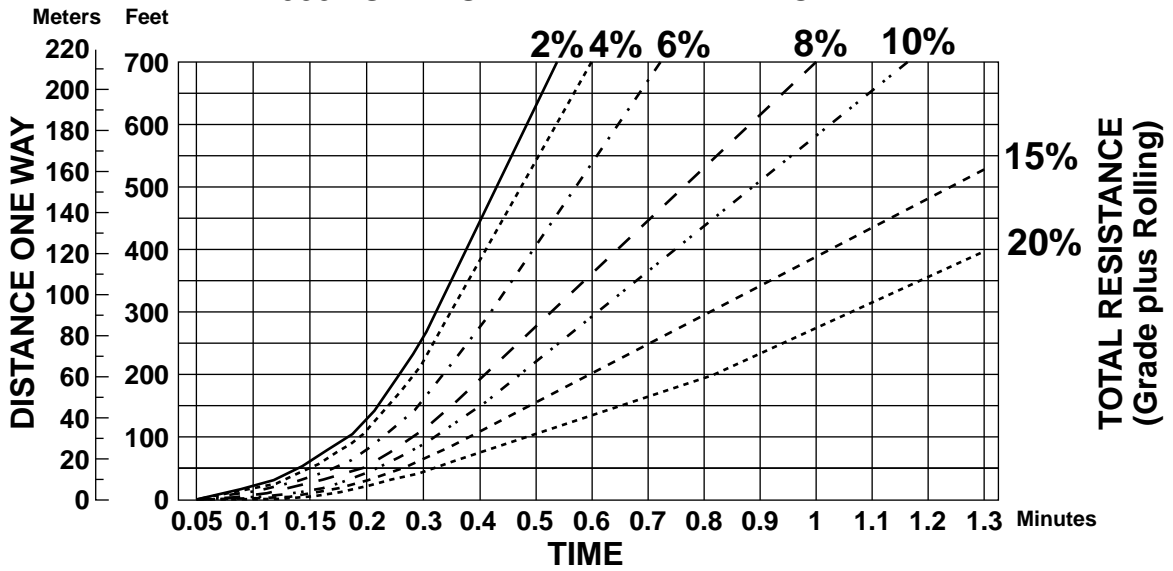

NOTE: Curves assume use of highest operating speed attainable: 4th gear for 2%-6% TR, 3rd gear for 8%-10% TR, 2nd gear for 15% and 20% TR.

In load-and-carry applications it is important to consult the tire manufacturer on Ton-MPH ratings and pressure recommendations.

Travel Time — Empty
 ● 988F Series II
 ● 35/65-33 Tires

Wheel Loaders

988F SERIES II TRAVEL TIME — EMPTY

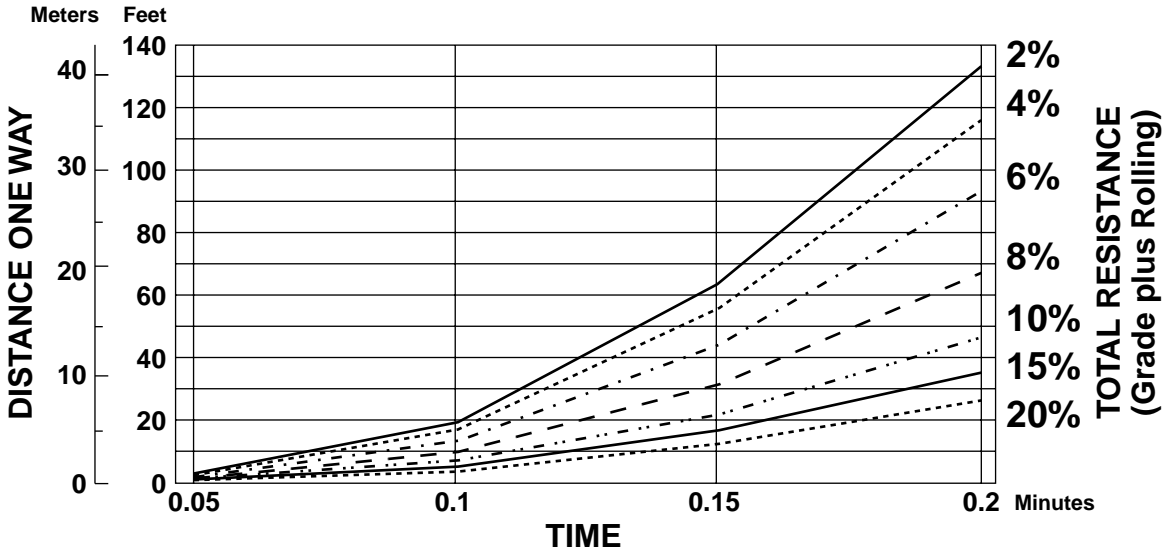
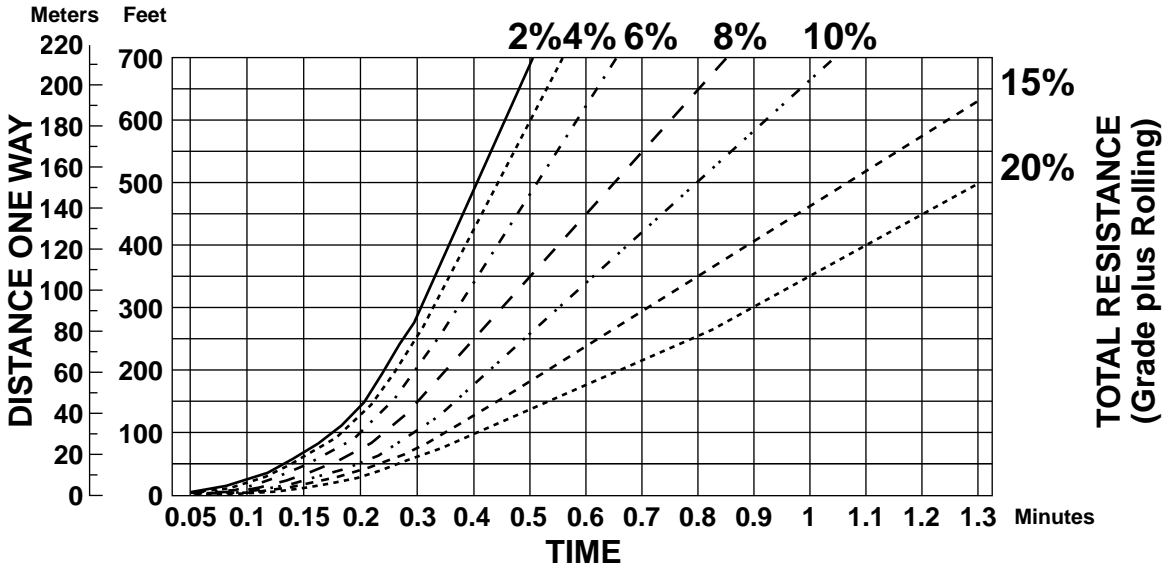

Wheel Loaders

Travel Time — Loaded

- 990 Series II
- 41.25/70-39 Tires

990 SERIES II TRAVEL TIME — LOADED

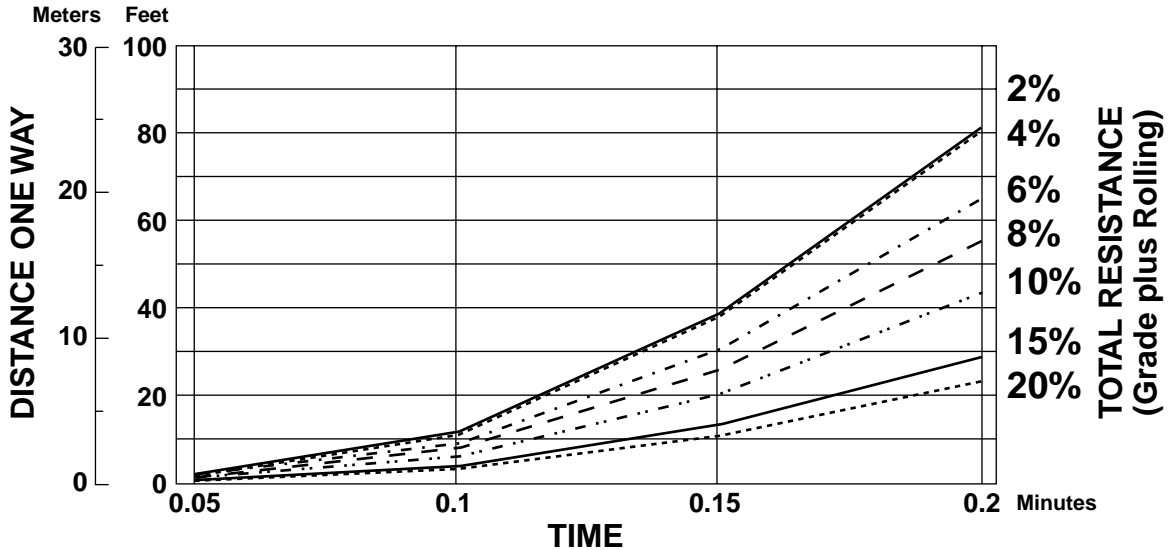
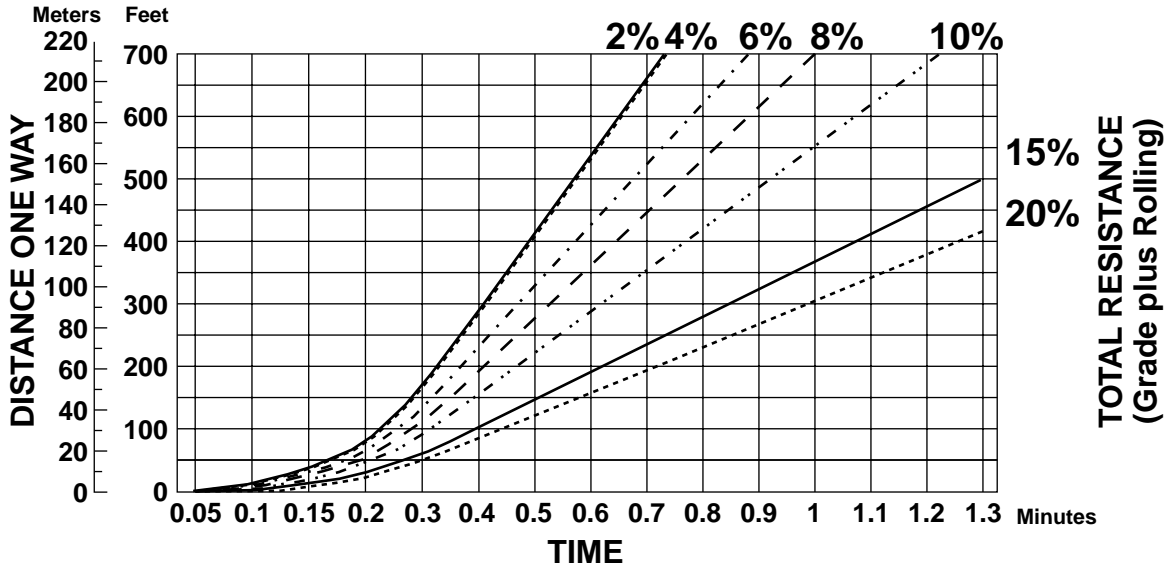

Travel Time — Empty
 ● 990 Series II
 ● 41.25/70-39 Tires

Wheel Loaders

990 SERIES II TRAVEL TIME — EMPTY

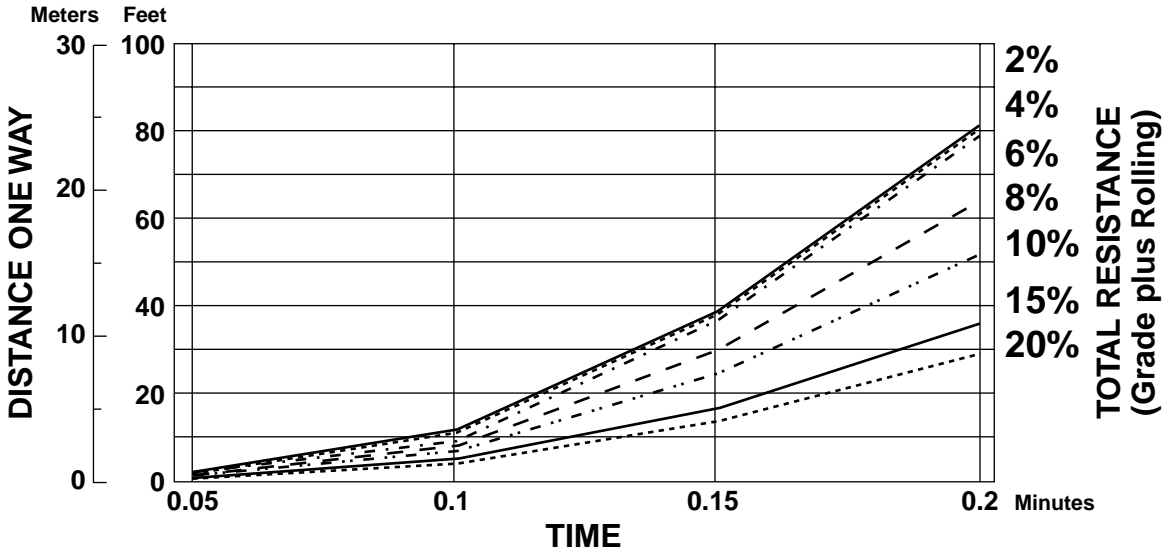
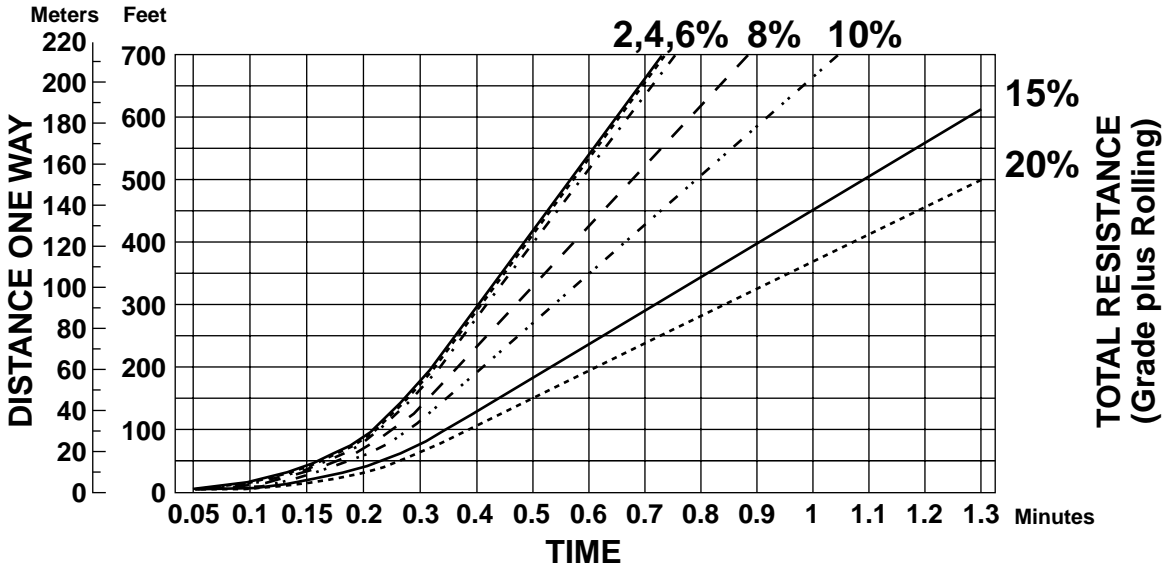

Wheel Loaders

Travel Time — Loaded

- 992G
- 45/65-45 Tires

992G TRAVEL TIME — LOADED

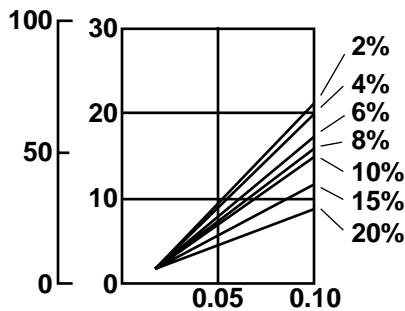
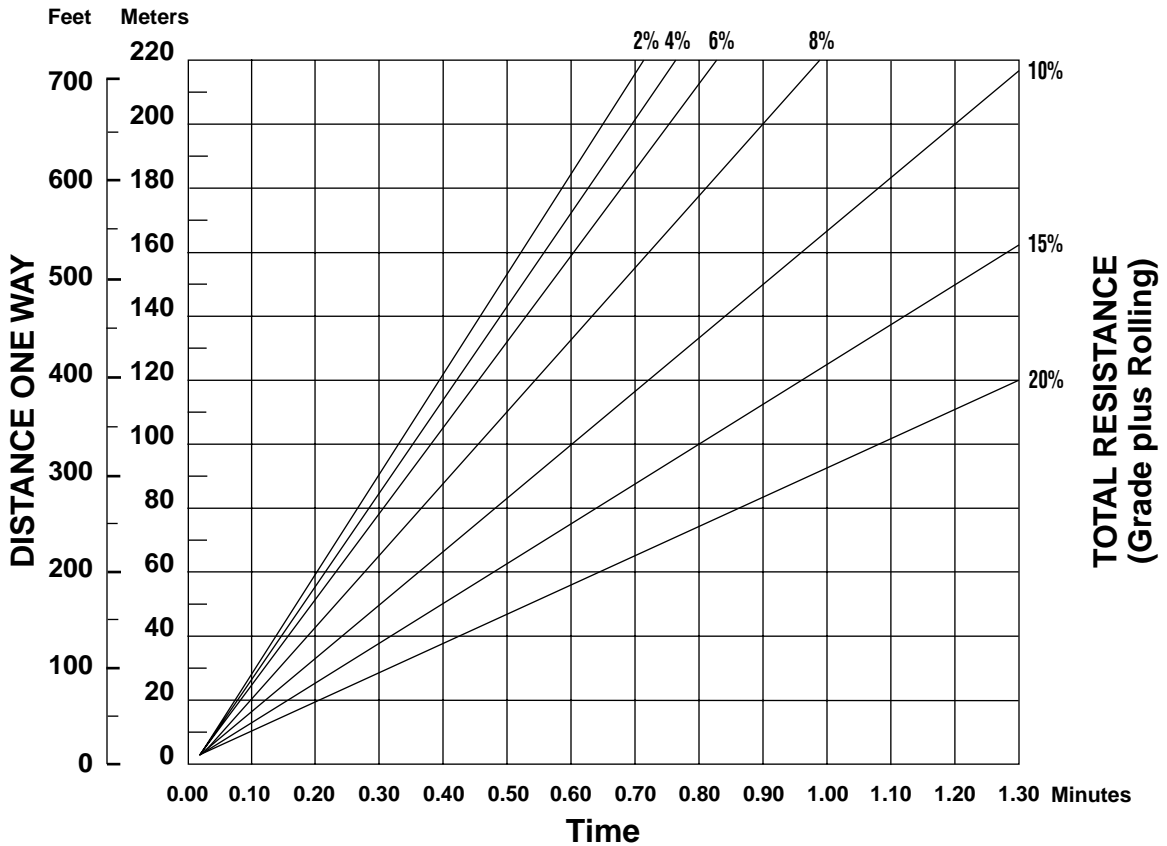

NOTE: Curves assume use of highest operating speed attainable: 3rd gear for 2%-10% TR, 2nd gear for 15% TR and 1st gear for 20% TR.

In load-and-carry applications it is important to consult the tire manufacturer on Ton-MPH ratings and pressure recommendations.

Travel Time — Empty
 ● 992G
 ● 45/65-45 Tires

Wheel Loaders

992G TRAVEL TIME — EMPTY

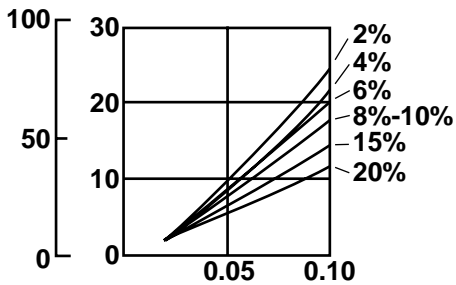
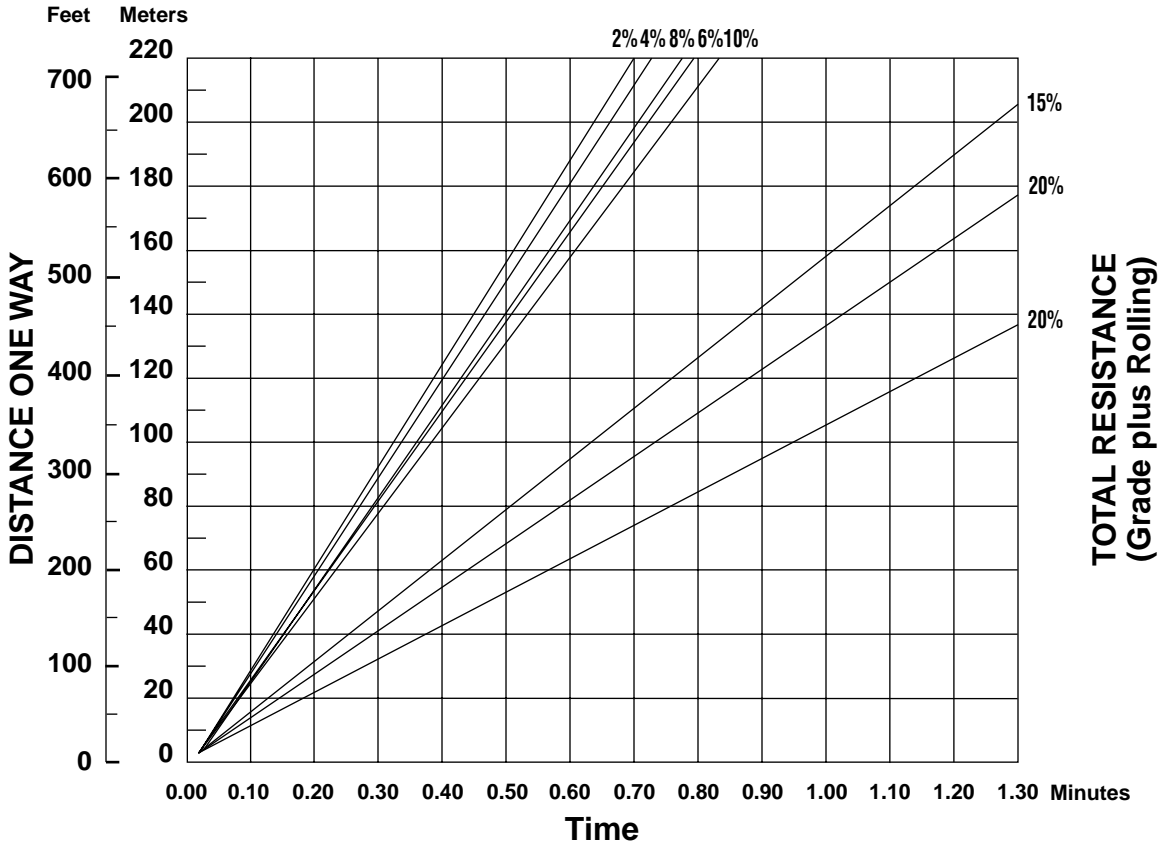

NOTE: Curves assume use of highest operating speed attainable: 3rd gear for 2%-10% TR, 2nd gear for 15% TR and 1st gear for 20% TR.

Wheel Loaders

Travel Time — Loaded

- 994
- 50/80-57 Tires

994 TRAVEL TIME — LOADED

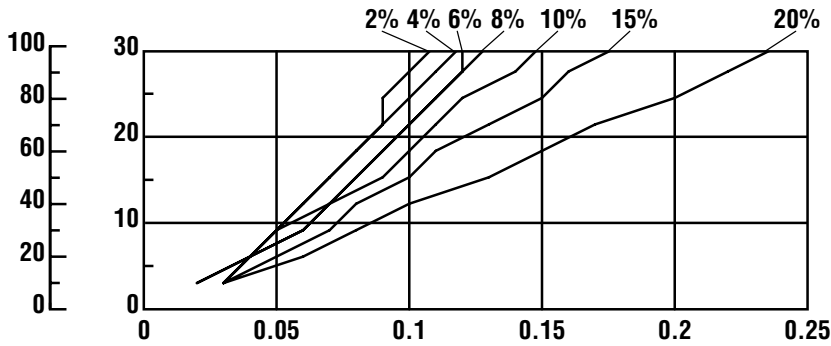
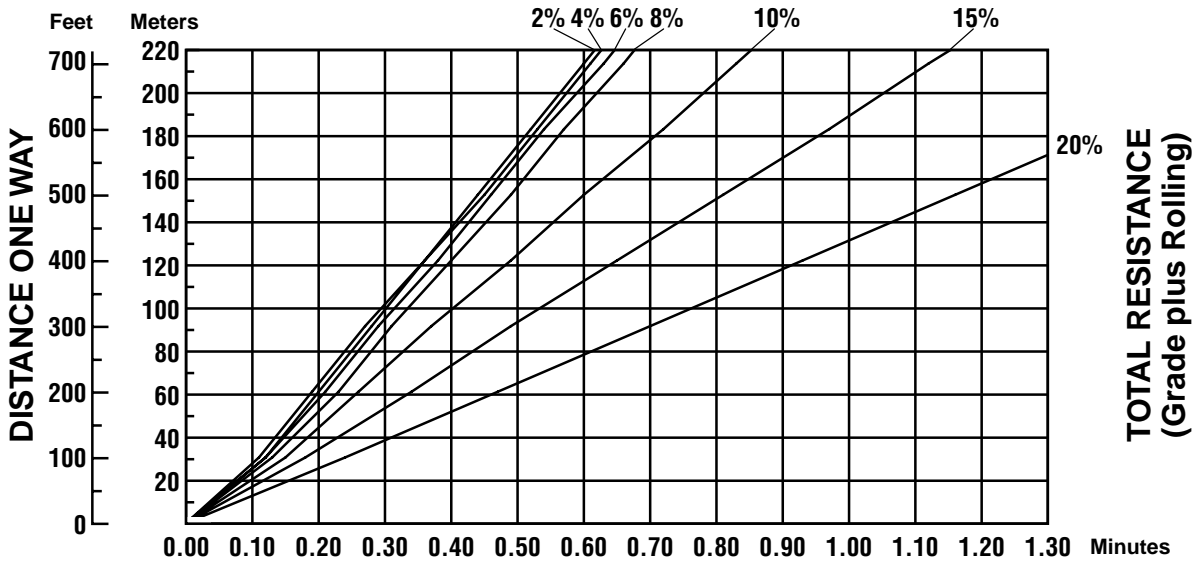

Travel Time — Empty
 ● 994
 ● 50/80-57 Tires

Wheel Loaders

994 TRAVEL TIME — EMPTY

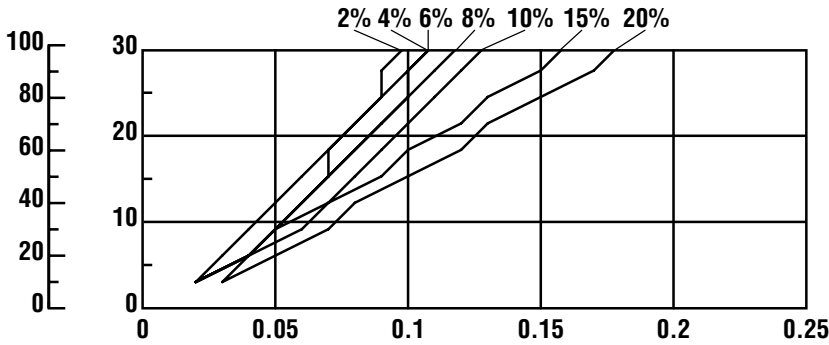
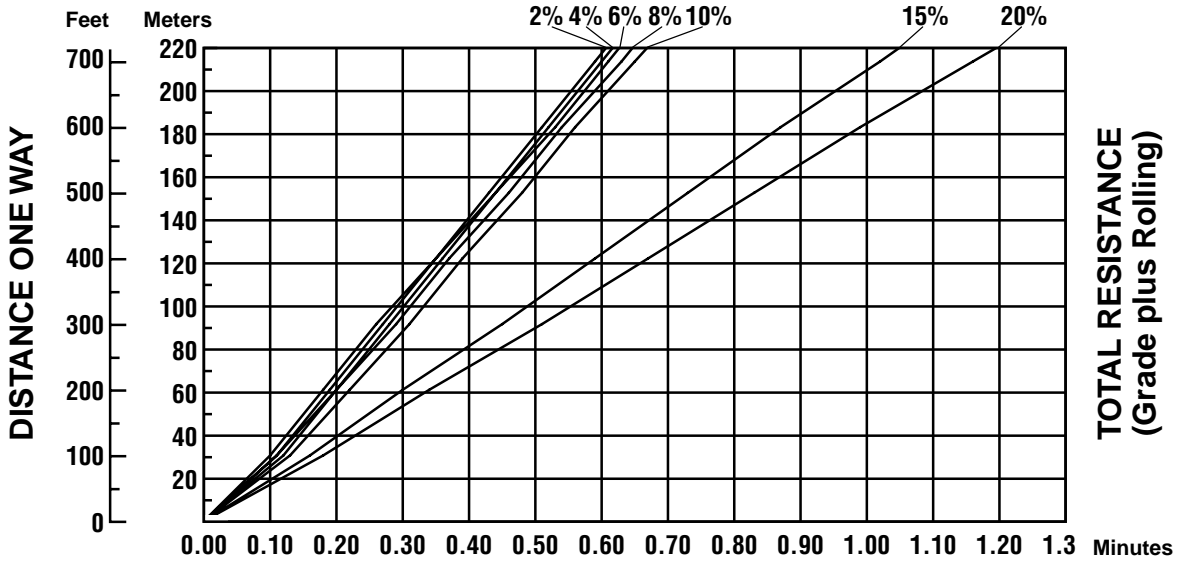

Wheel Loaders

Production Estimating Table

● m³ or yd³/60 min. hour

Bucket Size (m ³ or yd ³)		1.0	1.5	2.0	2.5	3.0	3.5	4.0	4.5	5.0	5.5	6.0	6.5	7.0	7.5	8.0	8.5	9.0	9.5	10.0	
Cycle Time	Cycles Per Hr	Unshaded area indicates average production.																			
0.35	171																				
0.40	150	150	225	330	375	450	525														
0.45	133	135	200	268	332	400	466	530	600	665	730	800	865								
0.50	120	120	180	240	300	360	420	480	540	600	660	720	780	840	900	960	1003	1080	1140	1200	
0.55	109	109	164	218	272	328	382	436	490	545	600	655	705	765	820	870	925	980	1008	1090	
0.60	100	100	150	200	250	300	350	400	450	500	550	600	650	700	750	800	850	900	950	1000	
0.65	92	92	138	184	230	276	322	368	416	460	505	555	600	645	690	735	780	830	875	920	
0.70	86							342	386	430	474	515	560	600	645	690	730	775	815	860	
0.75	80													560	600	640	680	720	760	800	

Bucket Size (m ³ or yd ³)		11.0	12.0	13.0	14.0	15.0	16.0	17.0	18.0	19.0	20.0	21.0	22.0	23.0	24.0	25.0	26.0
Cycle Time	Cycles Per Hr	Unshaded area indicates average production.															
0.35	171																
0.40	150																
0.45	133																
0.50	120	1320	1440														
0.55	109	1200	1310	1420	1520	1635	1740	1850	1960	2070	2180	2285	2395	2505	2615	2725	2830
0.60	100	1100	1200	1300	1400	1500	1600	1700	1800	1900	2000	2100	2200	2300	2400	2500	2600
0.65	92	1010	1105	1195	1285	1380	1470	1560	1655	1745	1840	1930	2020	2115	2205	2300	2390
0.70	86	945	1030	1120	1200	1290	1375	1460	1545	1630	1720	1805	1890	1975	2060	2150	2235
0.75	80	880	960	1040	1120	1200	1280	1360	1440	1520	1600	1680	1760	1840	1920	2000	2080
0.80	75			975	1050	1125	1200	1275	1350	1425	1500	1575	1650	1725	1800	1875	1950

Job Efficiency Worktime/Hr	Efficiency Factor	Bucket Load Factor Bucket Size × 1.00
60 Min Hr	100%	
55	91%	.95
50	83%	.90
45	75%	.85
40	69%	.80
—	—	.75

Production Estimating Table
 ● 60 min hour ● Shot Rock
 ● Metric Tons

Wheel Loaders

Metric Tons ● 1600 kg Lm³ (1.6 t) density

Bucket Size m ³		1.0	1.5	2.0	2.5	3.0	3.5	4.0	4.5	5.0	5.5	6.0	6.5	7.0	7.5	8.0	8.5	9.0	9.5
Cycle Time	Cycles Per Hr	Unshaded area indicates average production.																	
0.40	150	240	360	480	600	720													
0.45	133	213	319	426	532	638	745	851	958	1064	1170								
0.50	120	192	288	384	480	576	672	768	864	960	1056	1152	1248	1344	1440	1536	1632	1730	1825
0.55	109	174	262	349	436	523	610	698	785	872	959	1046	1134	1221	1308	1395	1482	1570	1655
0.60	100	160	240	320	400	480	560	640	720	800	880	960	1040	1120	1200	1280	1360	1440	1520
0.65	92	147	221	294	368	442	515	589	662	736	810	883	957	1030	1104	1178	1251	1325	1400
0.70	86						482	550	619	688	757	826	894	963	1032	1101	1170	1238	1310
0.75	80											768	832	896	960	1024	1088	1150	1215
Bucket Payload Metric (Tons)		1.6	2.4	3.2	4.0	4.8	5.6	6.4	7.2	8.0	8.8	9.6	10.4	11.2	12.0	12.8	13.6	14.4	15.2

Bucket Size m ³		10.0	11.0	12.0	13.0	14.0	15.0	16.0	17.0	18.0	19.0	20.0
Cycle Time	Cycles Per Hr	Unshaded area indicates average production.										
0.40	150											
0.45	133											
0.50	120											
0.55	109	1744	1918	2092	2267	2441	2616	2790	2964	3139	3313	3488
0.60	100	1600	1760	1920	2080	2240	2400	2560	2720	2880	3040	3200
0.65	92	1472	1619	1766	1913	2060	2208	2355	2502	2649	2796	2944
0.70	86	1376	1513	1651	1788	1926	2064	2201	2339	2476	2614	2752
0.75	80	1280	1408	1536	1664	1792	1920	2048	2176	2304	2432	2560
0.80	75	1200	1320	1440	1560	1680	1800	1920	2040	2160	2280	2400
Bucket Payload Metric (Tons)		16	17.6	19.2	20.8	22.4	24.0	25.6	27.2	28.8	30.4	32.0

Wheel Loaders

Production Estimating Table

- Shot Rock
- 60 min hour
- U.S. Tons

U.S. Tons ● 2700 lb/LCY (1.35 T) density

Bucket Size yd ³		1.0	1.5	2.0	2.5	3.0	3.5	4.0	4.5	5.0	5.5	6.0	6.5	7.0	7.5	8.0	8.5	9.0	9.5	10.0
Cycle Time	Cycles Per Hr	Unshaded area indicates average production.																		
0.40	150	203	330	420	510	615	705	810												
0.45	133	180	293	360	454	545	625	720	810	905	985	1080	1170							
0.50	120	162	254	324	408	492	565	650	730	815	890	970	1060	1140	1200	1300	1380	1470	1540	1620
0.55	109	147	240	294	370	448	515	590	665	740	805	885	960	1030	1090	1180	1250	1330	1400	1740
0.60	100	135	220	270	340	410	470	540	610	680	740	810	880	950	1000	1080	1150	1220	1280	1350
0.65	92	124	200	250	314	380	435	500	560	625	680	750	810	875	920	985	1060	1120	1180	1250
0.70	86								525	585	635	695	755	815	860	930	990	1050	1100	1160
0.75	80													760	800	865	920	975	1030	1080
Bucket Payload (Tons)		1.35	2.2	2.7	3.4	4.1	4.7	5.4	6.1	6.8	7.4	8.1	8.8	9.5	10.0	10.8	11.5	12.2	12.8	13.5

Bucket Size yd ³		11.0	12.0	13.0	14.0	15.0	16.0	17.0	18.0	19.0	20.0	21.0	22.0	23.0	24.0	25.0	26.0
Cycle Time	Cycles Per Hr	Unshaded area indicates average production.															
0.40	150																
0.45	133																
0.50	120	1782	1945														
0.55	109	1620	1765	1905	2060	2200	2350	2495	2645	2790	2940	3080	3235	3375	3530	3670	3825
0.60	100	1485	1620	1750	1890	2020	2160	2290	2430	2560	2700	2830	2970	3100	3240	3370	3510
0.65	92	1365	1490	1610	1735	1855	1985	2105	2235	2355	2480	2600	2730	2850	2980	3100	3225
0.70	86	1275	1390	1505	1625	1735	1855	1965	2085	2200	2320	2430	2550	2665	2785	2895	3015
0.75	80	1190	1295	1400	1510	1615	1725	1830	1940	2045	2160	2260	2375	2480	2590	2695	2805
0.80	75			1310	1415	1515	1620	1715	1820	1920	2025	2120	2225	2325	2430	2525	2630
Bucket Payload (Tons)		14.9	16.4	17.5	18.9	20.2	21.6	22.9	24.3	25.6	27.0	28.3	29.7	31.0	32.4	33.7	35.1

Work Tools	992G	990 Series II	988F Series II	980G	970F	966F Series II	962G	950G	938G	928G	924F	914G	906	902
Quick coupler	X		X	X		X		X	X	X	X	X	X	X
General purpose bucket	X	X	X	X		X	X	X	X	X	X	X	X	X
Coke bucket														
Coal bucket	X	X	X	X	X	X	X	X	X	X	X	X		
Coal seam bucket	X	X												
Woodchip bucket			X	X		X		X	X	X	X	X		
Refuse bucket				X		X		X			X			
Light material bucket					X	X	X	X	X				X	X
Loose material bucket										X	X			
Snow bucket						X		X						
Fertilizer bucket										X	X	X		
Sand & gravel bucket				X	X	X	X	X						
Crushed rock bucket					X									
Rock bucket	X		X	X										
Skeleton rock bucket			X			X								
Slag bucket	X		X	X		X								
Bonus bucket			X											
Multi-purpose bucket						X		X	X	X	X			
Side dump bucket						X		X	X	X	X		X	X
Control discharge bucket														
Bucket with top clamp										X	X			
Tire loader														
Material handling arm			X	X		X		X	X	X	X	X		
Pallet fork	X	X	X	X		X		X	X	X	X	X	X	X
Pallet fork with top clamp						X		X	X	X	X			
Millyard fork			X	X		X		X	X	X				
Log/lumber fork						X		X	X	X	X	X		
Logging fork		X	X	X		X		X						
Core fork								X	X	X				
Grab & Grip bucket									X	X				
Straight blade			X	X					X	X	X	X		
Manual angle blade						X		X	X	X				
Hydraulic angle blade						X		X		X				
V-plow						X		X	X	X		X		
Manual reverse plow						X		X		X	X	X		
Hydraulic reverse plow						X		X		X	X	X		
Clamp rake														
Clearing rake														
Loader rake						X		X	X	X	X	X		
Hydraulic broom												X	X	X
Block handling bucket			X											
Block handling fork			X	X										
Breaker tine			X	X										
Boom clearing rake			X											
Stone seive bucket													X	X
High dump bucket													X	X
Pickup sweeper													X	X

NOTE: List is not all-inclusive. Contact Balderson for special attachment needs.

WASTE HANDLING WHEEL LOADERS

CONTENTS

Features	12-75
Options	12-75
Specifications	12-76

Caterpillar Waste Handling Wheel Loaders are equipped with the features and protection required in a demanding waste handling environment. These Caterpillar designed and built machines feature the following advantages:

- **Exceptional productivity** with fast cycle times for maximum production day-in day-out whether dozing, loading, stacking, or load and carry.
- **Protected work environment** enhances operator comfort, convenience and productivity.
- **Modified front frames** – (Standard on the 966F Series II WHA) provide large cutouts that allows debris to fall out rather than packing and also provide easy access if cleaning is necessary.
- **Standard front drive guard and axle seal guards** protect from wire, string, strapping and other debris from wrapping around and causing damage.
- **Front light guards** protect the lights from debris falling over the bucket spill plate.
- **Hinged crankcase and power train guards** help protect the engine and power train. The hinged design provides easy access for cleaning. (Powered guards available on some models.)
- **Standard waste application cooling system.** The improved, trash-resistant, multi-row module (IMRM) radiator, hood and engine enclosures work as a system to keep the radiator and engine compartment free of debris.
- **Trash resistant IMRM radiator** has six fins per inch (25.4 mm) and in-line tubes that resist plugging by allowing debris to pass through the core.
- **Hinged radiator prescreener** eliminates debris larger than what the radiator core will pass.
- **Suction fan** on 966F II pulls cooler outside air through the prescreener and radiator helping prevent debris from entering through other openings. Reduces trash build-up and fire risk.
- **Air conditioning** features a roof mounted condenser improves air conditioning and engine cooling efficiency. Standard on some models, optional on others.

Recommended Waste Handling Options

- **Powered crankcase and power train guards** raise and lower at the flip of a switch allowing fast, easy and frequent cleanings.
- **High lift arrangement** increases bucket hinge pin height offering increased stacking and stockpiling capability. A critical feature when incoming volumes exceed conveyor capacity, floor space or when a unit goes down.
- **Traction control system (TCS)** option for 938G provides maximum traction in slippery conditions. TCS electronically senses and limits wheel slip at each wheel independently.
- **Limited-slip differential** limits tire slip on both front and rear axles. Increases traction and reduces tire wear and scuffing in wet or dry conditions. Provides an alternative to the No SPIN differential which is not recommended due to increased tire wear, turning interference and poor tracking on dry surfaces.
- **Tire options:**
 - L-5 bias hard rock lug
 - L-5 slick
 - RL-5K Goodyear radials
 - XMINE Michelin radials (varies by model)
 - Foam-filled
- **Articulation guards** (938G only) help protect components in hitch area from damage.
- **Bolt-on power train and crankcase guards** on 938G and 950G help protect from contact damage.

Attachments

- **Refuse bucket** has excellent dozing and stock-piling capability. Large spill plate helps protect the machine from debris falling over the top of the bucket. Available in pin-on or quick coupler configurations.
- **Pallet forks** are ideal for handling refuse destined for further recycling or stacking refuse in landfills for covering.

- **Multi-purpose bucket** has the capability to clamp and sort large objects, doze cover material or other light dozing chores.
- **Quick coupler** increases versatility by allowing a single machine to utilize a wide variety of attachments in a host of applications.



MODEL	938G WHA		950G WHA		966F Series II WHA	
Flywheel Power	108 kW	145 hp	127 kW	170 hp	164 kW	220 hp
Peak Power	115 kW	158 hp	138 kW	185 hp	—	—
Engine Model	3126T		3126TA		3306T	
Rated Engine RPM	2200		2200		2200	
Bore	110 mm	4.3"	110 mm	4.3"	121 mm	4.75"
Stroke	127 mm	5"	127 mm	5"	152 mm	6"
No. Cylinders	6		6		6	
Displacement	7.2 L	439 in³	7.2 L	439 in³	10.5 L	638 in³
Speeds Forward	km/h	mph	km/h	mph	km/h	mph
1st	7	4.3	6.9	4.3	7.3	4.5
2nd	12.7	7.9	12.7	7.9	13	8.1
3rd	21.9	13.6	22.3	13.9	22.5	14
4th	35.9	22.3	37	23	38.8	24.1
Speeds Reverse						
1st	7	4.3	7.6	4.7	8.3	5.2
2nd	12.7	7.9	13.9	8.7	14.8	9.2
3rd	21.9	13.6	24.5	15.3	25.6	15.9
4th	—	—	40.5	25.3	43.9	27.3
Hydraulic Cycle Time*						
Rated Load in Bucket:	Seconds		Seconds		Seconds	
Raise	6		6.3		7.1	
Dump	1.4		2.2		2	
Lower (empty, float down)	2.8		2.2		2.4	
Total	10.2		10.7		11.5	
Tread Width**	2.02 m	6'8"	2.14 m	7'0"	2.20 m	7'3"
Width Over Tires**	2.60 m	8'6"	2.89 m	9'6"	2.94 m	9'8"
Ground Clearance**	400 mm	16"	400 mm	16"	476 mm	18.7"
Fuel Tank Capacity	254 L	67 U.S. gal	295 L	78 U.S. gal	304 L	79 U.S. gal
Hydraulic Tank Capacity	90 L	23.8 U.S. gal	153 L	40.4 U.S. gal	205 L	54 U.S. gal
Hinge Pin Height						
Full Lift Std.	3.84 m	12'7"	3.98 m	13'1"	4.12 m	13'5"
High Lift w/ L-5 tires	4.20 m	13'9"	4.54 m	14'11"	4.80 m	15'9"
Operating weight up to:	13 605 kg	30,000 lb	18 027 kg	39,750 lb	26 400 kg	58,200 lb

*With standard lift arms.

**With standard tires.

TRACK LOADERS

CONTENTS

Features	13-1
Specifications	13-2
Performance data	13-4
Machine dimensions with general purpose bucket	13-12
Multi-purpose bucket dimensions	13-13
Rippers/Scarifiers	13-14
SAE loader ratings	13-15
Estimating cycle time	13-16
Bucket fill factors	13-17
Recommended operating capacities	13-17
Loader production	13-17
Estimating bucket load	13-17
Estimating production	13-18
Production and machine selection:	
Alternative method of selection	13-18
Nomographs	13-19
Travel time charts	13-21
Production estimating table	13-23
Waste handling track loaders	13-25
Attachments	13-27

Features of 933C and 939C:

- **Hydrostatic drive train** offers infinitely variable speeds, fast acceleration, dynamic hydrostatic braking, superior maneuverability and excellent controllability.

Features of 953C-973

- **Rear engine location** provides natural stability as a “working” counterweight, excellent visibility and good weight to horsepower ratio.
- **Hydrostatic drive train** offers independent control of each track, power turns, infinitely variable speeds, fast acceleration and counterrotation for increased production.
- **Z-bar linkage** provides increased breakout force, fewer grease points and fast dump speed.
- **Pilot operated hydraulic controls** offer low lever forces for precise, consistent bucket control and reduces operator fatigue.
- **Implement power requirements** have priority over track requirements automatically ... full implement power available for maximum breakout force and simultaneous lift and dump capability results in fast loading and cycle time.
- **Oscillating track roller frames** decrease ground shock, increase machine stability.

Features common to all models:

- **Sound-suppressed, air-pressurized, resiliently mounted ROPS cab** for superior working environment.
- **Sealed and Lubricated Track** reduces wear and maintenance expense.
- **Sealed loader linkage** extends lubrication intervals and reduces maintenance time.
- **Automatic bucket controls** let bucket rise to pre-set dumping height and return to pre-set digging angle for fast cycle time.
- **Radial rippers** are Multishank with wide beam coverage for utility ripping close to walls, footings and embankments. Five shanks available for 933 and 939. Three shanks for 953C, 963B and 973.



MODEL	933C		939C	
Flywheel Power	52 kW	70 hp	67.1 kW	90 hp
Operating Weight*	8485 kg	18,690 lb	9480 kg	20,900 lb
Engine Model	3046		3046	
Rated Engine RPM	2400		2400	
Bore	94 mm	3.7"	94 mm	3.7"
Stroke	120 mm	4.7"	120 mm	4.7"
No. Cylinders	6		6	
Displacement	5 L	305 in ³	5 L	305 in ³
Speeds Forward/Reverse	0-9 km/h	0-5.6 mph	0-9 km/h	0-5.6 mph
Hydraulic Cycle Time, Bucket Empty, in Seconds:				
Raise	5.8		5.6	
Dump	1.7		2.4	
Lower (Empty, Float Down)	2		2.9	
Total	9.5		10.9	
Track Rollers (Each Side)	6		6	
Width of Standard Track Shoe	356 mm	14"	406 mm	16"
Length of Track on Ground	2.05 m	6'8.9"	2.14 m	7'0.4"
Ground Contact Area (With Std. Shoe)	1.46 m ²	2265 in ²	1.74 m ²	2700 in ²
Ground Pressure	54 kPa	7.8 psi	53.7 kPa	7.8 psi
Ground Clearance	324 mm	12.8"	369 mm	14.5"
Track Gauge	1.45 m	4'9"	1.55 m	5'1"
Width Without Bucket	1.81 m	5'11"	1.96 m	6'5"
Fuel Tank Refill Capacity	157 L	41.4 U.S. gal	157 L	41.4 U.S. gal
Hydraulic System Refill Capacity	56.8 L	15 U.S. gal	56.8 L	15 U.S. gal
	LGP		LGP	
(Specs that differ from above)	933C		939C	
Operating Weight	8744 kg	19,260 lb	No	
Width of Track Shoe	635 mm	2'1"	LGP	
Ground Contact Area	2.60 m ²	4045 in ²	Model	
Ground Pressure	32.8 kPa	4.76 psi		
Track Gauge	1.68 m	5'6"		
Width Without Bucket	2.31 m	7'7"		

See Wheel Loader section of this book for summary of S.A.E. Guidelines for Loader Specifications, to which Caterpillar adheres.

*933C weights for standard and LGP models include basic machine (General Arrangement Number), lubricants, coolant, full fuel tank, operator, general purpose bucket, bucket teeth, and OROPS.

939C weights include basic machine (General Arrangement Number), lubricants, coolants, full fuel tank, operator, general purpose bucket and bucket teeth and OROPS.



MODEL	953C		963B		973	
Flywheel Power	90 kW	121 hp	119 kW	160 hp	157 kW	210 hp
Operating Weight*	14 680 kg	32,360 lb	19 630 kg	43,280 lb	25 040 kg	55,200 lb
Engine Model	3116T		3116TA		3306T	
Rated Engine RPM	2200		2200		2200	
Bore	105 mm	4.13"	105 mm	4.13"	121 mm	4.75"
Stroke	127 mm	5"	127 mm	5"	152 mm	6"
No. Cylinders	6		6		6	
Displacement	6.6 L	403 in³	6.6 L	403 in³	10.5 L	638 in³
Speeds Forward/Reverse	km/h	mph	km/h	mph	km/h	mph
1st	0-10	0-6.2	0-10.1	0-6.3	0-10.3	0-6.4
2nd	Infinitely		Infinitely		Infinitely	
3rd	Variable		Variable		Variable	
Hydraulic Cycle Time, Bucket Empty, in Seconds:						
Raise		6.7		6.2		7.4
Dump**		1.4		1.3		1.4
Lower (Empty, Float Down)		3		2.3		2.6
Total		9.7		8.5		10
Track Rollers (Each Side)	6		6		7	
Width of Standard Track Shoe	380 mm	15"	450 mm	17.7"	500 mm	19.7"
Length of Track on Ground	2.295 m	7'6"	2.454 m	8'1"	2.917 m	9'7"
Ground Contact Area (With Std. Shoe)	1.74 m ²	2704 in²	2.21 m ²	3423 in²	2.92 m ²	4522 in²
Ground Pressure	82.5 kPa	11.97 psi	86.8 kPa	12.6 psi	84.1 kPa	12.2 psi
Ground Clearance	377 mm	14.8"	439 mm	17"	456 mm	17.9"
Track Gauge	1.80 m	5'11"	1.85 m	6'0.8"	2.08 m	6'10"
Width Without Bucket	2.18 m	7'2"	2.30 m	7'6.5"	2.58 m	8'6"
Fuel Tank Refill Capacity	241 L	63.8 U.S. gal	296 L	78 U.S. gal	356 L	94 U.S. gal
Hydraulic System Refill Capacity	104 L	27.5 U.S. gal	138 L	36 U.S. gal	120 L	31.6 U.S. gal
Equipped With Wide Track Shoe Option						
(Specs that differ from above)	953C		963B		973	
Operating Weight	14 970 kg	33,010 lb	19 900 kg	43,880 lb	25 534 kg	56,293 lb
Width of Track Shoe	500 mm	1'8"	550 mm	1'9.7"	675 mm	2'2.6"
Ground Contact Area	2.30 m ²	3558 in²	2.70 m ²	4184 in²	3.94 m ²	6104 in²
Ground Pressure	63.9 kPa	9.28 psi	72.3 kPa	10.5 psi	64.2 kPa	9.14 psi
Track Gauge	1.80 m	5'11"	1.85 m	7'6.5"	2.08 m	6'10"
Width Without Bucket	2300 mm	7'6"	2400 mm	9'4.2"	2755 mm	9'0"

*Includes GP bucket with bolt-on adapters, long tips and segments.

**Simultaneous lift/dump.

See Track Loader section of this book for summary of S.A.E. Guidelines for Loader Specifications, to which Caterpillar adheres.

BUCKET	General Purpose		Multi-Purpose		LGP Arrangement	
Capacity, Rated (Nominal Heaped)	1 m ³	1.3 yd³	0.96 m ³	1.25 yd³	0.96 m ³	1.25 yd³
Struck	0.84 m ³	1.1 yd³	0.79 m ³	1.03 yd³	0.8 m ³	1.05 yd³
Bucket Width*	1969 mm	6'5"	1969 mm	6'5"	2330 mm	7'8"
Dump Clearance at Full Lift and 45° Discharge	2692 mm	8'10"	2642 mm	8'8"	2728 mm	8'11"
Maximum Reach at Full Lift and 45° Discharge	839 mm	2'9"	859 mm	2'9.8"	803 mm	2'7.6"
Digging Depth	148 mm	5.8"	160 mm	6.3"	148 mm	5.8"
Overall Length	4352 mm	14'3"	4352 mm	14'3"	4301 mm	14'1"
Overall Height	4426 mm	14'6"	4426 mm	14'6"	4203 mm	13'9"
Static Tipping Load	5821 kg	12,834 lb	5626 kg	12,392 lb	5630 kg	12,400 lb
Breakout Force**	77.4 kN	17,390 lb	71.3 kN	16,000 lb	83.6 kN	18,790 lb
Operating Weight***	8042 kg	17,730 lb	9010 kg	19,840 lb	8744 kg	19,260 lb

*Bolt-on teeth increase bucket width by 42 mm (1.65"). Bolt-on cutting edge increases bucket width by 10 mm (0.39").

**Breakout force is measured 102 mm (4") behind tip of cutting edge with bucket hinge pin as pivot point.

***Operating weight includes coolant, lubricants, full fuel tank, bottom guards (STD), bucket teeth, ROPS canopy and operator. 426 kg (940 lb) counterweight is also included with Multi-Purpose bucket.

Machine stability can be affected by the addition of other attachments. Add or subtract the following to/from machine operating weight and static tipping load:

	Change in Operating Weight		Change in Static Tipping Load	
	kg	lb	kg	lb
Cab, ROPS	+204	+450	+253	+558
Bucket teeth (long) & segments	+179	+394	-226	-498
Air Conditioner	+ 77	+170	+ 84	+185
457 mm (18") shoes	+108	+238	+ 76	+168
Ripper with 3 teeth (includes removal of 295 kg (650 lb) rear counterweight)	+ 13	+ 29	+ 48	+106
Rear counterweight (per plate)	+116	+255	+195	+430

BUCKET	General Purpose		Multi-Purpose	
Capacity, Rated (Nominal Heaped)	1.15 m ³	1.5 yd ³	1.15 m ³	1.5 yd ³
Struck	0.95 m ³	1.25 yd ³	0.95 m ³	1.25 yd ³
Bucket Width*	2160 mm	7'1"	2160 mm	7'1"
Dump Clearance at Full Lift and 45° Discharge	2667 mm	8'9"	2604 mm	8'6.5"
Maximum Reach at Full Lift and 45° Discharge	866 mm	2'10.1"	877 mm	2'10.5"
Digging Depth	127 mm	5"	165 mm	6.5"
Overall Length	4359 mm	14'3.6"	4411 mm	14'6"
Overall Height	4384 mm	14'4.6"	4384 mm	14'4.6"
Static Tipping Load	6607 kg	14,565 lb	6396 kg	14,100 lb
Breakout Force**	89.9 kN	20,200 lb	92 kN	20,690 lb
Operating Weight***	9480 kg	20,910 lb	10 030 kg	22,110 lb

*Bolt-on teeth increase bucket width by 42 mm (1.65"). Bolt-on cutting edge increases bucket width by 10 mm (0.39").

**Breakout force is measured 102 mm (4") behind tip of cutting edge with bucket hinge pin as pivot point.

***Operating weight includes coolant, lubricants, full fuel tank, bottom guards (STD), bucket teeth, ROPS canopy and operator. 454 kg (1000 lb) rear counterweight is also removed while using Multi-Purpose bucket.

Machine stability can be affected by the addition of other attachments. Add or subtract the following to/from machine operating weight and static tipping load:

	Change in Operating Weight		Change in Static Tipping Load	
	kg	lb	kg	lb
Cab, ROPS	+204	+450	+266	+586
Bucket teeth (long) & segments	+118	+260	-150	-330
Air Conditioner	+ 77	+170	+ 88	+194
Ripper with 3 teeth (includes removal of 295 kg (650 lb) rear counterweight)	+ 17	+ 37	+ 49	+108
Rear counterweight (per plate)	+115	+255	+203	+448

BUCKET	1.75 m ³ /2.25 yd ³ General Purpose Bare		1.75 m ³ /2.25 yd ³ General Purpose Bolt-on Adapters, Long Tips & Segments		1.75 m ³ /2.25 yd ³ General Purpose Bolt-on Cutting Edge		1.75 m ³ /2.25 yd ³ General Purpose Weld-on Adapters & Tips	
	Capacity, Rated (Nominal Heaped) Struck	1.75 m ³ 2.25 yd ³ 1.45 m ³ 1.90 yd ³	1.85 m ³ 2.4 yd ³ 1.55 m ³ 2.05 yd ³	1.85 m ³ 2.4 yd ³ 1.55 m ³ 2.05 yd ³	1.85 m ³ 2.4 yd ³ 1.55 m ³ 2.05 yd ³	1.85 m ³ 2.4 yd ³ 1.55 m ³ 2.05 yd ³	1.85 m ³ 2.4 yd ³ 1.55 m ³ 2.05 yd ³	1.85 m ³ 2.4 yd ³ 1.55 m ³ 2.05 yd ³
Cutting Edge, Type	Straight		Straight		Straight		Straight	
Bucket Width◀	2380 mm 7'10"	2380 mm 7'10"	2380 mm 7'10"	2380 mm 7'10"	2380 mm 7'10"	2380 mm 7'10"	2380 mm 7'10"	2380 mm 7'10"
Teeth	None		8, optional, bolt-on with replaceable tips		None		8, weld-on with replaceable tips	
Dump Clearance @ Full Lift and 45° Discharge	2899 mm 9'6"	2706 mm 8'10"	2706 mm 8'10"	2706 mm 8'10"	2834 mm 9'3"	2732 mm 8'11"	2732 mm 8'11"	2732 mm 8'11"
Reach at 45° Discharge Angle 2133 mm (7') Clearance	1554 mm 5'1"	1495 mm 4'10"	1495 mm 4'10"	1495 mm 4'10"	1563 mm 5'1"	1457 mm 4'9"	1457 mm 4'9"	1457 mm 4'9"
Reach @ Full Lift and 45° Discharge	1011 mm 3'3.8"	1051 mm 3'5.4"	1051 mm 3'5.4"	1051 mm 3'5.4"	1051 mm 3'5.4"	998 mm 3'3.3"	998 mm 3'3.3"	998 mm 3'3.3"
Digging Depth	107 mm 4.2"	132 mm 5.2"	132 mm 5.2"	132 mm 5.2"	132 mm 5.2"	107 mm 4.2"	107 mm 4.2"	107 mm 4.2"
Overall Length	5889 mm 19'4"	6133 mm 20'1"	6133 mm 20'1"	6133 mm 20'1"	5988 mm 19'7"	6134 mm 20'1"	6134 mm 20'1"	6134 mm 20'1"
Overall Height	4869 mm 16'0"	4869 mm 16'0"	4869 mm 16'0"	4869 mm 16'0"	4869 mm 16'0"	4869 mm 16'0"	4869 mm 16'0"	4869 mm 16'0"
Static Tipping Load**	9931 kg 21,900 lb	9550 kg 21,060 lb	9550 kg 21,060 lb	9550 kg 21,060 lb	9672 kg 21,330 lb	9860 kg 21,740 lb	9860 kg 21,740 lb	9860 kg 21,740 lb
Breakout Force*	121 kN 27,220 lb	108.7 kN 24,460 lb	108.7 kN 24,460 lb	108.7 kN 24,460 lb	109.7 kN 24,680 lb	122.6 kN 27,580 lb	122.6 kN 27,580 lb	122.6 kN 27,580 lb
Operating Weight**	14 450 kg 31,870 lb	14 680 kg 32,360 lb	14 680 kg 32,360 lb	14 680 kg 32,360 lb	14 570 kg 32,140 lb	14 510 kg 32,000 lb	14 510 kg 32,000 lb	14 510 kg 32,000 lb

◀Bolt-on teeth increase bucket width by 52 mm (2"). Bolt-on cutting edge increases bucket width by 17 mm (0.67").

*Breakout force is measured 100 mm (3.94") behind tip of cutting edge with bucket hinge pin as pivot point.

**Operating weight includes coolant, lubricants, full fuel tank, ROPS cab, General Purpose bucket, and 80 kg (176 lb) operator.

Machine stability can be affected by the addition of other attachments. Add or subtract the following to/from machine operating weight and static tipping load:

	Change in Operating Weight		Change in Static Tipping Load for General Purpose Bucket	
	kg	lb	kg	lb
ROPS canopy only (cab removed)	-221	- 487	- 280	- 617
Ripper (includes rear hydraulic arrangement and bumper removal)	+ 20	+ 44	—	—
Air conditioner	+ 95	+ 209	+ 135	+ 298
Wide track shoes	+291	+ 642	+ 189	+ 417
Rear bumper (removed)	-564	-1243	-1180	-2601

BUCKET	Multi-Purpose Bare		Multi-Purpose Bolt-on Segments & Long Teeth		Multi-Purpose Bolt-on Cutting Edge	
Capacity, Rated (Nominal Heaped)	1.5 m ³	2 yd ³	1.6 m ³	2.1 yd ³	1.6 m ³	2.1 yd ³
Struck	1.25 m ³	1.65 yd ³	1.35 m ³	1.75 yd ³	1.35 m ³	1.75 yd ³
Cutting Edge, Type	Straight		Straight		Straight	
Bucket Width◄	2378 mm	7'10"	2378 mm	7'10"	2378 mm	7'10"
Teeth	None		8, optional, bolt-on with replaceable tips		None	
Dump Clearance @ Full Lift and 45° Discharge	2724 mm	8'11"	2655 mm	8'8"	2655 mm	8'8"
Reach at 45° Discharge Angle 2133 mm (7') Clearance	1440 mm	4'9"	1363 mm	4'6"	1433 mm	4'8"
Reach @ Full Lift and 45° Discharge	986 mm	3'2.8"	1019 mm	3'4.1"	1019 mm	3'4.1"
Digging Depth	158 mm	6.2"	182 mm	7.2"	182 mm	7.2"
Overall Length	6046 mm	19'10"	6261 mm	20'6"	6118 mm	20'0"
Overall Height	4860 mm	16'0"	4860 mm	16'0"	4860 mm	16'0"
Static Tipping Load**	8844 kg	19,500 lb	8490 kg	18,710 lb	8602 kg	18,970 lb
Breakout Force*	95.1 kN	21,400 lb	86.4 kN	19,440 lb	86.9 kN	19,550 lb
Operating Weight**	15 060 kg	33,200 lb	15 280 kg	33,690 lb	15 180 kg	33,470 lb

◄Bolt-on teeth increase bucket width by 52 mm (2"). Bolt-on cutting edge increases bucket width by 17 mm (0.67").

*Breakout force is measured 100 mm (3.94") behind tip of cutting edge with bucket hinge pin as pivot point.

**Operating weight includes coolant, lubricants, full fuel tank, ROPS cab, General Purpose bucket, and 80 kg (176 lb) operator.

Machine stability can be affected by the addition of other attachments.

BUCKET	General Purpose Bare		General Purpose Bolt-on Cutting Edge		General Purpose Weld-on Teeth		General Purpose Bolt-on Segments & Long Teeth	
	m ³	yd ³	m ³	yd ³	m ³	yd ³	m ³	yd ³
Capacity, Rated (Nominal Heaped) Struck	2.3 m ³	3 yd³	2.45 m ³	3.2 yd³	2.3 m ³	3 yd³	2.45 m ³	3.2 yd³
Cutting Edge, Type	Straight		Straight		Straight		Straight	
Bucket Width◀	2498 mm	8'2.3"	2498 mm	8'2.3"	2498 mm	8'2.3"	2498 mm	8'2.3"
Teeth	None		None		8, weld-on, flush mounted with replaceable tips		8, optional, bolt-on with replaceable tips	
Dump Clearance @ Full Lift and 45° Discharge	3144 mm	10'4"	3058 mm	10'0"	3087 mm	10'2"	3087 mm	10'2"
Reach at 45° Discharge Angle	1772 mm	5'10"	1801 mm	5'11"	1784 mm	5'10"	1784 mm	5'10"
2133 mm (7') Clearance								
Reach @ Full Lift and 45° Discharge	1157 mm	3'10"	1228 mm	4'0"	1190 mm	3'11"	1157 mm	3'10"
Digging Depth	88 mm	3.5"	118 mm	4.6"	88 mm	3.5"	113 mm	4.5"
Overall Length	6342 mm	20'10"	6465 mm	21'3"	6599 mm	21'8"	6599 mm	21'8"
Overall Height	5314 mm	17'5"	5314 mm	17'5"	5314 mm	17'5"	5314 mm	17'5"
Static Tipping Load**	13 429 kg	29,611 lb	13 033 kg	28,738 lb	13 357 kg	29,452 lb	12 867 kg	28,372 lb
Breakout Force*	171.5 kN	38,588 lb	153.4 kN	34,515 lb	171.5 kN	38,587 lb	152.1 kN	34,223 lb
Operating Weight**	19 295 kg	42,545 lb	19 503 kg	43,004 lb	19 367 kg	42,704 lb	19 626 kg	43,275 lb

◀Bolt-on teeth increase bucket width by 52 mm (2"). Bolt-on cutting edge increases bucket width by 33 mm (1.30").

*Breakout force is measured 100 mm (3.94") behind tip of cutting edge with bucket hinge pin as pivot point.

**Operating weight includes coolant, lubricants, full fuel tank, ROPS cab, General Purpose bucket, and 80 kg (176 lb) operator.

Machine stability can be affected by the addition of other attachments. Add or subtract the following to/from machine operating weight and static tipping load:

	Change in Operating Weight		Change in Static Tipping Load for General Purpose Bucket	
	kg	lb	kg	lb
Remove ROPS and cab	-475	-1048	- 573	-1264
ROPS canopy only (cab removed)	-168	- 371	- 192	- 423
Ripper (includes rear hydraulic arrangement and three shanks)	+569	+ 313	+1325	+2921
Air conditioner	+108	+ 238	+ 172	+ 379
Bumper (removed)	-260	- 573	- 561	-1239
Wide track shoes	+273	+ 602	+ 185	+ 408
Long teeth	+152	+ 334	- 203	- 448

BUCKET	Multi-Purpose Bare		Multi-Purpose Bolt-on Segments & Long Teeth		Multi-Purpose Bolt-on Cutting Edge	
Capacity, Rated (Nominal Heaped)	1.9 m ³	2.5 yd³	2 m ³	2.6 yd³	2 m ³	2.6 yd³
Struck	1.6 m ³	2.1 yd³	1.7 m ³	2.2 yd³	1.7 m ³	2.2 yd³
Cutting Edge, Type	Straight		Straight		Straight	
Bucket Width◀	2498 mm	8'2.3"	2498 mm	8'2.3"	2498 mm	8'2.3"
Teeth	None		8, optional, bolt-on with replaceable tips		None	
Dump Clearance @ Full Lift and 45° Discharge	2967 mm	9'9"	2906 mm	9'6"	2874 mm	9'5"
Reach at 45° Discharge Angle 2133 mm (7') Clearance	1582 mm	5'2"	1580 mm	5'2"	1590 mm	5'3"
Reach @ Full Lift and 45° Discharge	1038 mm	3'5"	1063 mm	3'6"	1088 mm	3'7"
Digging Depth	170 mm	6.5"	195 mm	7.5"	200 mm	8"
Overall Length	6454 mm	21'2"	6710 mm	22'0"	6575 mm	21'7"
Overall Height	5295 mm	17'4"	5295 mm	17'4"	5295 mm	17'4"
Static Tipping Load**	12 646 kg	27,884 lb	12 213 kg	26,930 lb	12 257 kg	27,027 lb
Breakout Force*	167.7 kN	37,732 lb	149.5 kN	33,638 lb	149.8 kN	33,705 lb
Operating Weight**	19 820 kg	43,703 lb	20 061 kg	44,235 lb	20 028 kg	44,162 lb

◀Bolt-on teeth increase bucket width by 52 mm (2"). Bolt-on cutting edge increases bucket width by 17 mm (0.67").

*Breakout force is measured 100 mm (3.94") behind tip of cutting edge with bucket hinge pin as pivot point.

**Operating weight includes coolant, lubricants, full fuel tank, ROPS cab, General Purpose bucket, and 80 kg (176 lb) operator.

Machine stability can be affected by the addition of other attachments.

BUCKET	General Purpose Bare		General Purpose Bolt-on Segments & Long Teeth		General Purpose Bolt-on Cutting Edge		Rock Weld-on Flush Teeth	
Capacity, Rated (Nominal Heaped) Struck	2.8 m ³	3.75 yd³	3.2 m ³	4.2 yd³	3.2 m ³	4.2 yd³	2.8 m ³	3.75 yd³
Cutting Edge, Type	Straight		Straight		Straight		Spade	
Bucket Width◀	2854 mm	9'4"	2854 mm	9'4"	2854 mm	9'4"	2705 mm	8'11"
Teeth	8, optional, bolt-on with replaceable tips		8, optional, bolt-on with replaceable tips		8, optional, weld-on with replaceable tips		8, optional, bolt-on with replaceable tips	
Dump Clearance @ Full Lift and 45° Discharge	3340 mm	10'11"	3266 mm	10'9"	3266 mm	10'9"	3014 mm	9'10"
Reach @ 45° Discharge Angle, 2.133 m (7') Clearance	2006 mm	6'7"	2029 mm	6'8"	2029 mm	6'8"	2023 mm	6'8"
Reach @ Full Lift and 45° Discharge	1328 mm	4'4"	1375 mm	4'6"	1375 mm	4'6"	1464 mm	4'9"
Digging Depth	118 mm	4.6"	148 mm	5.8"	148 mm	5.8"	118 mm	4.6"
Overall Length	7123 mm	23'4"	7123 mm	23'4"	6942 mm	22'9"	7296 mm	23'11"
Overall Height	5735 mm	19'0"	5785 mm	19'0"	5785 mm	19'0"	5726 mm	18'9"
Static Tipping Load**	16 788 kg	37,010 lb	16 503 kg	36,383 lb	16 696 kg	36,809 lb	16 678 kg	36,768 lb
Breakout Force*	213 kN	47,981 lb	197 kN	44,188 lb	198 kN	44,507 lb	183 kN	41,223 lb
Operating Weight**	24 902 kg	54,899 lb	25 037 kg	55,196 lb	24 894 kg	54,882 lb	24 908 kg	54,912 lb

◀Bolt-on teeth increase bucket width by 63.8 mm (2.5"). Bolt-on cutting edge increases bucket width by 19 mm (0.74").

*Breakout force is measured 100 mm (3.94") behind tip of cutting edge with bucket hinge pin as pivot point.

**Operating weight includes lubricants, full fuel tank, ROPS cab, General Purpose bucket, and 80 kg (176 lb) operator.

Machine stability can be affected by the addition of other attachments. Add or subtract the following to/from machine operating weight and static tipping load:

	Change in Operating Weight		Change in Static Tipping Load	
	kg	lb	kg	lb
Remove ROPS	- 485	-1070	- 545	-1202
ROPS canopy only (cab removed)	- 175	- 385	- 208	- 459
Ripper (includes rear hydraulic arrangement)	+1228	+2707	+2843	+6268
Air conditioner	+ 107	+ 236	+ 166	+ 366
Bumper	+ 151	+ 332	+ 345	+ 761
Wide track shoes	+ 632	+1394	+ 476	+1050
Long teeth	+ 223	+ 492	- 305	- 672

BUCKET	Multi-Purpose Bare		Multi-Purpose Bolt-on Segments & Long Teeth		Multi-Purpose Bolt-on Cutting Edge		Steel Mill Arrangement	
Capacity, Rated (Nominal Heaped)	2.6 m ³	3.40 yd³	2.9 m ³	3.8 yd³	2.9 m ³	3.8 yd³	2.5 m ³	3.25 yd³
Struck	2.419 m ³	2.87 yd³	2.56 m ³	3.34 yd³	2.56 m ³	3.34 yd³	2.03 m ³	2.65 yd³
Cutting Edge, Type	Straight		Straight		Straight		Semi-Spade	
Bucket Width◀	2710 mm	8'11"	2710 mm	8'11"	2710 mm	8'11"	2714 mm	8'11"
Teeth	8, optional, bolt-on with replaceable tips		8, optional, bolt-on with replaceable tips		8, optional, weld-on with replaceable tips		6, standard, weld-on with replaceable tips	
Dump Clearance @ Full Lift and 45° Discharge	3044 mm	9'11"	2965 mm	9'9"	2965 mm	9'9"	2986 mm	9'10"
Reach @ 45° Discharge Angle, 2.133 m (7') Clearance	1859 mm	6'1"	1861 mm	6'1"	1861 mm	6'1"	1784 mm	5'10"
Reach @ Full Lift and 45° Discharge	1287 mm	4'2"	1324 mm	4'4"	1324 mm	4'4"	1237 mm	4'1"
Digging Depth	211 mm	8.3"	241 mm	9.5"	241 mm	9.5"	118 mm	4.6"
Overall Length	7318 mm	24'1"	7318 mm	24'1"	7221 mm	23'8"	7572 mm	24'10"
Overall Height	5894 mm	19'4"	5894 mm	19'4"	5894 mm	19'4"	5825 mm	19'1"
Static Tipping Load**	14 120 kg	31,130 lb	13 930 kg	30,711 lb	14 114 kg	31,116 lb	18 470 kg	40,720 lb
Breakout Force*	174 kN	39,026 lb	161 kN	36,281 lb	163 kN	36,591 lb	203 kN	45,765 lb
Operating Weight**	26 086 kg	57,510 lb	26 205 kg	57,772 lb	26 067 kg	57,467 lb	27 551 kg	60,740 lb

◀Bolt-on teeth increase bucket width by 63.8 mm (2.5"). Bolt-on cutting edge increases bucket width by 19 mm (0.74").

*Breakout force is measured 100 mm (3.94") behind tip of cutting edge with bucket hinge pin as pivot point.

**Operating weight includes lubricants, full fuel tank, ROPS cab, General Purpose bucket, and 80 kg (176 lb) operator.

Machine stability can be affected by the addition of other attachments.

933C-939C

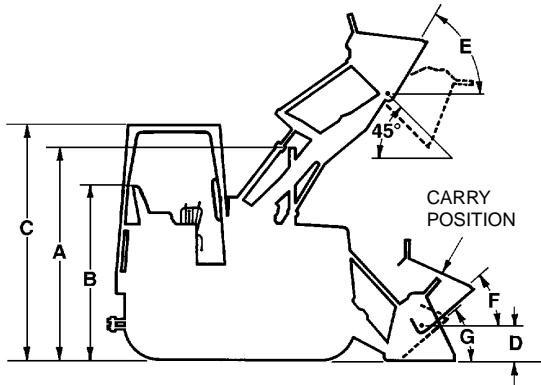

953C-973

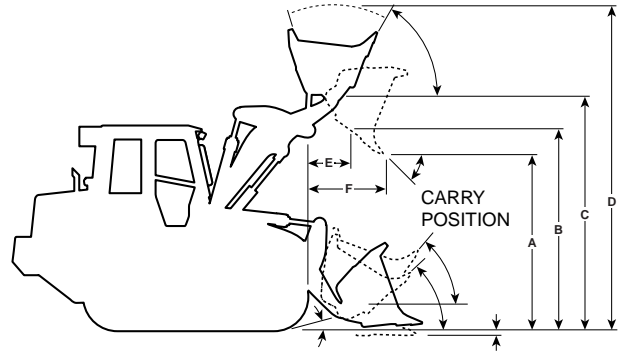

	933C		939C		953C	
A Height to Top of Stack	2.80 m	9'2"	2.81 m	9'2"	2.441 m	8'0"
B Height to Top of Seat	2 m	6'7"	2 m	6'7"	2.353 m	7'9"
C Height to Top of ROPS	2.73 m	9'0"	2.74 m	9'0"	3.084 m	10'1"
D Hinge Pin Height at Carry Position	402 mm	15.8"	414 mm	16.3"	424 mm	16.7"
E Rollback at Maximum Lift		67.7°		67.7°		56°
F Rollback at Carry Height		51.2°		51.2°		48°
G Rollback at Ground Level		42.8°		42.6°		41°
Grading Angle (Bare Edge)		—		—		74°
Width Without Bucket (std. track)	1.80 m	5'11"	1.96 m	6'5"	2.18 m	7'2"
(optional track)	2.31 m	7'7"	2.01 m	6'7"	2.30 m	7'7"

	963B		973	
A Height to Top of Stack	3307 mm	10'11"	3.357 m	11'0"
B Height to Top of Seat	2681 mm	8'10"	2.681 m	8'10"
C Height to Top of ROPS	3423 mm	11'3"	3.423 m	11'3"
D Hinge Pin Height at Carry Position	467 mm	18.4"	492 mm	17.4"
E Rollback at Maximum Lift		59°		59°
F Rollback at Carry Height		50°		50°
G Rollback at Ground Level		42°		42°
Grading Angle (Bare Edge)		68°		69°
Width Without Bucket (std. track)	2580 mm	8'6"	2580 mm	8'6"
(optional track)	2755 mm	9'0.9"	2760 mm	9'0"

Multi-Purpose Bucket Dimensions
 • Bare Cutting Edge

Track Loaders

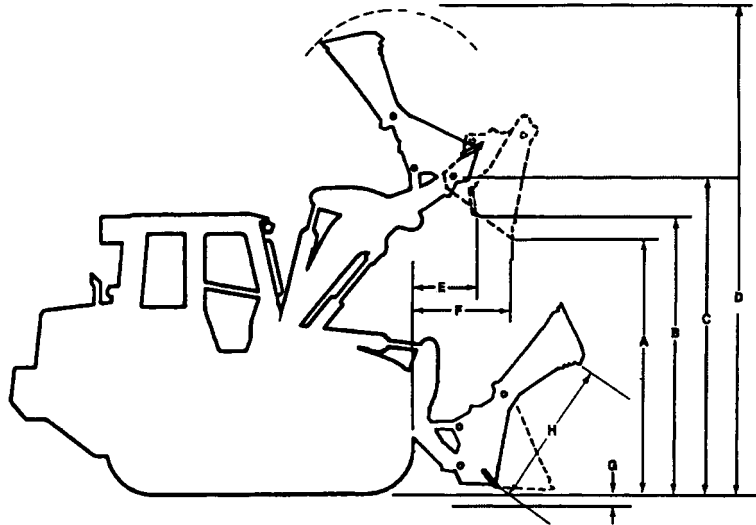

	933C		939C		953C	
A Forward Dump Clearance*	2.56 m	8'5"	2.57 m	8'5"	2.72 m	8'11"
B Bottom Dump Clearance*	2.62 m	8'7"	3.05 m	10'0"	3.16 m	10'5"
C Hinge Pin Height*	3.31 m	10'10"	3.32 m	10'11"	3.60 m	11'10"
D Overall Height	4.67 m	15'4"	4.68 m	15'4"	5.37 m	17'8"
E Bottom Dump Reach	453 mm	18"	453 mm	18"	540 mm	1'9.3"
F Forward Dump Reach*	859 mm	2'10"	776 mm	2'7"	986 mm	3'3"
G Digging Depth	184 mm	7.2"	190 mm	7.5"	158 mm	6.2"
H Bucket Opening	1103 mm	3'7"	930 mm	3'0"	1140 mm	3'9"
Reach at 2133 mm (7'0") Height*	1200 mm	3'11"	1200 mm	3'11"	1440 mm	4'9"
Tilt Back at Ground Level		43°		43°		43°
Closure Force, Clamp to Cutting Edge	50.7 kN	11,400 lb	56.8 kN	12,780 lb	71.8 kN	16,134 lb
Weight of Bucket and Additional Hydraulics	754 kg	1663 lb	1005 kg	2216 lb	1413 kg	3115 lb

	963B		973	
A Forward Dump Clearance*	3.04 m	9'11"	3.04 m	10'0"
B Bottom Dump Clearance*	3.50 m	11'6"	3.65 m	12'0"
C Hinge Pin Height*	4.22 m	13'10"	4.22 m	13'10"
D Overall Height	5.89 m	19'4"	6.52 m	21'5"
E Bottom Dump Reach	612 mm	2'0.1"	721 mm	2'4.4"
F Forward Dump Reach*	2967 mm	9'9"	1290 mm	4'2"
G Digging Depth	211 mm	8.3"	211 mm	8.3"
H Bucket Opening	1260 mm	4'1"	1380 mm	4'6"
Reach at 2133 mm (7'0") Height*	1590 mm	5'2"	1860 mm	6'1"
Tilt Back at Ground Level		42°		45°
Closure Force, Clamp to Cutting Edge	72.3 kN	16,250 lb	89 kN	20,000 lb
Weight of Bucket and Additional Hydraulics	2884 kg	6359 lb	2829 kg	6237 lb

*45° Discharge and full lift.
 Operator may prefer to tip bucket forward when bottom dumping.

TRACK LOADER	933C		939C		953C		963B		973	
Ripper-Scarifier Type	—		Radial		Radial		Radial		Radial	
Dimensions:										
Ripper Shank										
Maximum digging depth	276 mm	10.9"	193 mm	7.6"	284 mm	11.2"	360 mm	14.2"	428 mm	16.8"
Maximum reach at ground line	721 mm	2'4.4"	504 mm	1'7.8"	1092 mm	3'7"	1160 mm	3'9.7"	1295 mm	4'3"
Maximum ground clearance under tip (shank pinned in bottom hole)	520 mm	1'8.5"	604 mm	1'11.8"	415 mm	1'8.3"	513 mm	1'8.2"	670 mm	2'2.4"
Maximum ramp angle, ripper up (shank pinned in bottom hole)	24°		30.5°		19°		19°		20°	
Shank section	36 × 76 mm 1.4" × 3"		36 × 76 mm 1.4" × 3"		50 × 109 mm 2" × 4.3"		58 × 139 mm 2.3" × 5.5"		74 × 175 mm 2.9" × 6.9"	
Ripper Beam										
Overall width	1.58 m	5'2"	1.58 m	5'2"	1.95 m	6'5"	1.95 m	6'5"	2.20 m	7'3"
Height	130 mm	5.1"	130 mm	5.1"	165 mm	6.5"	165 mm	6.5"	216 mm	8.5"
Length	140 mm	5.5"	140 mm	5.5"	211 mm	8.3"	211 mm	8.3"	254 mm	10"
Number of Pockets	5		5		3		3		3	
Pocket Spacing	356 mm	14"	356 mm	14"	900 mm	2'11.4"	896 mm	2'11.3"	1000 mm	3'3.4"
Shank Gauge	1.42 m	4'8"	1.42 m	4'8"	1.80 m	5'11"	1.79 m	5'11"	2 m	6'7"
Track clearance with standard shoe	151 mm	5.9"	151 mm	5.9"	NA		NA		NA	
Installed weights:										
Ripper with standard shanks	250 kg	550 lb	250 kg	550 lb	428 kg	944 lb	563 kg	1241 lb	1228 kg	2707 lb
Each additional shank	11 kg	24 lb	11 kg	24 lb	NA		NA		NA	
Ripper Forces*:										
Penetration Force	2650 kg	5843 lb	2687 kg	5924 lb	4707 kg	10,380 lb	6385 kg	14,080 lb	8820 kg	19,450 lb
Pryout Force	5265 kg	11,610 lb	5265 kg	11,610 lb	10 388 kg	22,905 lb	13 897 kg	30,640 lb	17 450 kg	38,480 lb

*These values may vary slightly with different vehicle configurations.

NA – Not Applicable

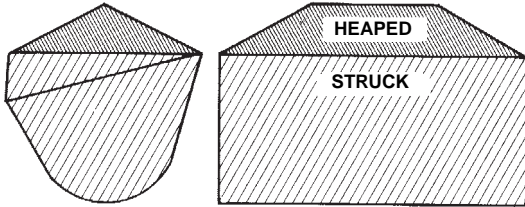
SAE BUCKET RATING**SAE Bucket Capacities**

Struck capacity is that volume contained in a bucket after a load is leveled by drawing a straight edge resting on the cutting edge and the back of the bucket.

Heaped capacity is a struck capacity *plus* that additional material that would heap on the struck load at a 2:1 angle of repose with the struck line parallel to the ground.

SAE J742 (Oct. 79) specifies that the addition of any auxiliary spill guard to protect against spillage of material which might injure the operator will not be included in bucket capacity ratings. Buckets with irregular shaped cutting edges (vee edge) the strike plane should be drawn at one-third the distance of the protruding portion of the cutting edge. Caterpillar rock buckets are built with integral see-through rock guards. Caterpillar light material buckets come standard with bolt-on edges. These features which add to actual bucket capacity are included in published ratings.

Dump Height

SAE J732 JUN92 specifies that dump height is the vertical distance from the ground to the lowest point of the cutting edge with the bucket hinge pin at maximum height and the bucket at a 45° dump angle. Dump angle is the angle in degrees that the longest flat section of the inside bottom of the bucket will rotate below horizontal.

Static Tipping Load

The minimum weight at center of gravity of “SAE Rated” load in bucket which will rotate rear of machine to a point where, on track loaders, front rollers are clear of the track under the following conditions:

- Loader on hard level surface and stationary.
- Unit at standard operating weight.
- Bucket at maximum rollback position.

- Load at maximum forward position during raising cycle.
- Unit with standard equipment as described in specifications unless otherwise noted under the heading.

Operating Load

In order to comply with SAE standard J818 MAY87, the operating load for track loaders should not exceed 35% of the Static Tipping load rating. See “Performance Data” of each machine in this handbook for increases to static tipping load by adding cab, counterweights, ripper-scarifier, etc.

SELECTING A MACHINE**Steps in selecting the proper size loader:**

- Determine production required or desired.
- Determine loader cycle time and cycles per hour. A machine size must be assumed to select a basic cycle time.
- Determine required payload per cycle in loose cubic yards and pounds (meters and kilograms).
- Determine bucket size needed.
- Make machine selection using bucket size and payload as criteria to meet production requirements.
- Compare the loader cycle time used in calculations to the cycle time of the machine selected. If there is a difference, rework the process beginning at step 2.

1. Production Required

The production required of a track loader should be slightly greater than the production capability of the other critical units in the earth or material moving system. For example, if a hopper can handle 300 tons per hour, a loader capable of slightly more than 300 tons should be used. Required production should be carefully calculated so the proper machine and bucket selections are made.

2. Loader Cycle Times

Material type, pile height, and other factors may improve or reduce production, and should be added to or subtracted from the basic cycle time when applicable.

When hauls are involved, obtain haul and return portions of the cycle from the estimated travel chart (this section). Add the haul and return times to the estimated basic cycle time to obtain total cycle time.

CYCLE TIME FACTORS

A basic cycle time (Load, Dump, Maneuver) of 0.25-0.35 minutes is average for a track loader [the basic cycle for large loaders, 2 m³ (2.6 yd³) and up, can be slightly longer], but variations can be authenticated in the field. The following values for many variable elements are based on normal operations. Adding or subtracting any of the variable times will give the total basic cycle time.

Estimating Cycle Time

Cycle time of a track loader needs to be determined to find loads per hour. Total cycle time includes the following segments:

Load Time + Maneuver Time + Travel Time + Dump Time

Load Time —

Material	Minutes
Uniform aggregates	0.03-0.05
Moist mixed aggregates	0.03-0.06
Moist loam	0.03-0.07
Soil, boulders, roots	0.04-0.20
Cemented materials	0.05-0.20

Maneuver Time — includes basic travel, four changes of direction and turning time, and will be about 0.20 minutes with a competent operator.

Travel Time — in a load and carry operation is comprised of haul and return times which can be determined by the travel charts in this section.

Dump Time — is dictated by the size and strength of the dump target and varies from 0.00 to 0.10 minutes. Typical dump times into highway trucks are from 0.04 to 0.07 minutes.

NOTE: When comparing hydrostatic track loaders with former power shift models (using the production estimating method) two factors must be considered: (1) The hydrostatic loaders on the average outcycle power shift models by up to 10 percent due to faster machine speed and easier operation. (2) Hydrostatic loaders incorporate Z-bar linkage, which provides substantially better bucket fill factors. The degree to which each factor affects estimated production should be left to the user’s judgment depending on the particular job application and conditions.

Example: Moist loam is being excavated from a bank and loaded into trucks.

	Minutes
Load — moist loam	0.05
Maneuver Time	0.20
Travel — none	
required	0.00
Dump	<u>0.05</u>
Total Cycle	0.30 min. or 200 cycles per 60 min. hour

*Minutes added (+)
or Subtracted (-)
From Basic Cycle*

Materials

- Mixed+0.02
- Up to 3 mm (1/8 in)+0.02
- 3 mm (1/8 in) to 20 mm (3/4 in)-0.02
- 20 mm (3/4 in) to 150 mm (6 in) 0.00
- 150 mm (6 in) and over+0.03 and Up
- Bank or broken+0.04 and Up

Pile

- Conveyor or Dozer piled 3 m (10 ft) and up 0.00
- Conveyor or Dozer piled 3 m (10 ft) or less+0.01
- Dumped by truck+0.02

Miscellaneous

- Common ownership of trucks and loadersUp to -0.04
- Independently owned trucksUp to +0.04
- Constant operationUp to -0.04
- Inconsistent operationUp to +0.04
- Small targetUp to +0.04
- Fragile targetUp to +0.05

Using actual job conditions and the above factors, total cycle time can be estimated. Convert total cycle time to cycles per hour.

$$Cycles\ per\ hour\ at\ 100\%\ Efficiency = \frac{60\ Min}{Total\ Cycle\ Time\ in\ Minutes}$$

Job efficiency is an important factor in machine selection. Efficiency is the actual number of minutes worked during an hour. Job efficiency accounts for operator breaks, and other work interruptions. See “Efficiency Considerations” page 13-18

- Bucket Fill Factors
- Recommended Operating Capacities
- Loader Production

Bucket Fill Factors

The following indicates the approximate amounts of material as a percent of rated bucket capacity which will actually be delivered per bucket per cycle. This is known as “Bucket Fill Factor.”

Loose Material	Fill Factor
Mixed Moist Aggregates	95-110%
Uniform Aggregates	95-110
3 mm-9 mm (1/8 in-3/8 in)	90-110
12 mm-20 mm (1/2 in-3/4 in)	90-110
24 mm and over (1 in)	90-110
Blasted Rock	
Well	80-95%
Average	75-90
Poor	60-75
Other	
Rock Dirt Mixtures	100-120%
Moist Loam	100-120
Soil, Boulders, Roots	80-100
Cemented Materials	85-100

Fill factors on track loaders are affected by bucket penetration, breakout force, rackback angle, bucket profile and ground engaging tools such as bucket teeth or bolt-on replaceable cutting edges and segments.

**GENERAL PURPOSE BUCKET
MAXIMUM OPERATING CAPACITIES**

MODEL	GENERAL PURPOSE BUCKET SIZE		MAXIMUM OPERATING CAPACITY	
	m ³	yd ³	kg	lb
933C	1.0	1.3	1770	3900
939C	1.15	1.5	2040	4500
953C	1.75	2.25	3410	7490
963B	2.3	3.0	4700	10,360
973	2.8	3.75	6265	13,190

LOADER PRODUCTION

Loader production equals quantity of material the bucket carries per load × number of bucket loads per hour.

Estimating Bucket Load

The quantity of material in a loader bucket is estimated by two methods, depending on whether the material being loaded is in a loose or bank state.

1. When the material is loose, as in stockpile loading, the bucket load is estimated in loose meters (or cubic yards) by a Bucket Fill Factor (see Tables Section or chart following this discussion). The quantity of material is determined as follows:
 Rated Bucket Capacity × Bucket Fill Factor = Bucket Payload in Loose m³ (yd³)

For example, a 973 with a 2.8 m³ (3.75 yd³) General-Purpose bucket loading uniform aggregate from a stockpile will carry:

$$2.8 \text{ m}^3 \times 1.0 = 2.8 \text{ loose cubic meters}$$

$$(3.75 \text{ yd}^3 \times 1.0 = 3.75 \text{ loose cubic yards})$$

Once the potential bucket load has been determined, check the static tipping load ratings on the specific machine to determine if bucket load is in fact a safe operating load. (*Safe operating load as defined by SAE for track loaders should not exceed 35% of static tipping load.*)

Productivity in many applications is measured in tons. See Tables Section for material densities if conversion to tons is desired.

2. When material is in the bank state, as in excavation, productivity is measured in bank meters (cubic yards). Bucket load in Bm³ (BCY) is estimated by applying one of the load factors from the Tables section to convert the excavated material in the bucket from Bm³ (BCY) to Lm³ (LCY) to allow for the digging and carrying characteristics of the material. The quantity of excavated material a bucket carries is then determined as follows:

$$\text{Rated Bucket Capacity} \times \text{Load Factor} \times \text{Bucket Fill Factor} = \text{Bucket Payload in Bm}^3 \text{ (BCY)}$$

Example: a 953C with a 1.75 m³ (2.25 yd³) General Purpose bucket loading wet loam earth from bank:

$$1.75 \text{ m}^3 \times 0.80 \times 1.15 = 1.61 \text{ Bm}^3$$

$$(2.25 \text{ yd}^3 \times 0.80 \times 1.15 = 2.07 \text{ BCY})$$

- Estimating Production
- Alternative Machine Selection Method

Estimating Production

Machine and job considerations include:

- Machine model and bucket size
- Material type, particle size, density and load factor (see Tables Section)
- Bucket fill factor
- Haul distance
- Underfoot conditions
- Altitude
- Dump target size, height, and type

Example:

Conditions —

Machine	953C
Bucket size	1.75 m ³ (2.25 yd ³)
Material	Moist Loam
Bucket fill factor	1.15
Haul length	30 m (100 ft)
Dump target	Pile
Travel in forward speed	

Cycle Time

	Minutes
Load time	0.03 min
Maneuver time	0.20
Travel time (from curves)	0.40
Dump time	0.00
Total	<u>0.63 min</u>

Loads Per Hour —

$$\frac{60 \text{ min/hr}}{0.63 \text{ min/cycle}} = 95 \text{ cycles per hour}$$

@ 100% efficiency

Load Per Cycle —

$$1.75 \text{ m}^3 \times 1.15 \text{ BFF} = 2.0 \text{ Lm}^3 \times 0.81 \text{ LF}$$

$$= 1.63 \text{ Bm}^3$$

$$(2.25 \text{ yd}^3 \times 1.15 \text{ BFF} = 2.58 \text{ LCY} \times 0.81 \text{ LF}$$

$$= 2.10 \text{ BCY})$$

Hourly Production —

$$1.63 \text{ Bm}^3 \times 95 \text{ cycles/h} = 154.9 \text{ Bm}^3/\text{h}$$

$$(2.10 \text{ BCY} \times 95 \text{ cycles/hr} = 199.1 \text{ BCY/hr})$$

Efficiency Considerations

Loader capacity should always be matched to peak production requirements of the job. Actual “on-the-job” loader productivity will be influenced by factors such as operator skill, personal delays, job layout and other delays. Experience and knowledge of local conditions will be the best indicators of actual job efficiency.

Operation	Working Hour	Efficiency Factor
Day	50 min/Hr	0.83

An Alternative Machine Selection Method

Another method of selecting the right Track Loader and bucket to meet production requirements is by use of the nomographs on the following pages. The method is quicker and easier than the preceding example because it does not require as many calculations, yet the accuracy is about the same within the normal limits of input data.

Be careful when entering and reading data from the nomographs because some scales increase from bottom to top, while others are the reverse. Do not be overly concerned with the precision as affected by pencil line width or reading to the hundredth of a m³ (yd³). Remember that bucket fill factor, material density, and cycle time are at best close estimates.

Example problem

A track loader must produce 180 Lm³ (235 LCY) per hour. Estimated cycle time is 0.5 minutes, working 50 minutes per hour. Bucket fill factor is 100% and the material density is 1600 kg/Lm³ (2700 lb/LCY).

Determine bucket size, machine model and hourly production in tons and yards.

Solution:

At full efficiency, it will cycle 120 times per hour. Since only an average 50 minutes are available, only 100 cycles will be completed per hour.

Starting on Scale A at 100 cycles per hour draw a straight line intersecting 180 m³/hr (235 yd³/hr) on Scale B and continuing the line on to Scale C giving 1.80 m³ (2.35 yd³) required payload.

Follow steps 1 through 7 on the next two pages.



Production and Machine Selection Nomograph

- To find required bucket payload and bucket size

Track Loaders

- Enter Scale A cycles per hour (100) and B hourly production 180 m³/hr (235 yd³/hr).
- Connect A and B and extend to C to find required payload 1.8 m³ (2.35 yd³).
- Connect C to bucket fill factor on Scale D (1.0) and extend to E to find required bucket size 1.8 m³ (2.35 yd³).
- Transfer Scale A and C readings to nomograph on following page.

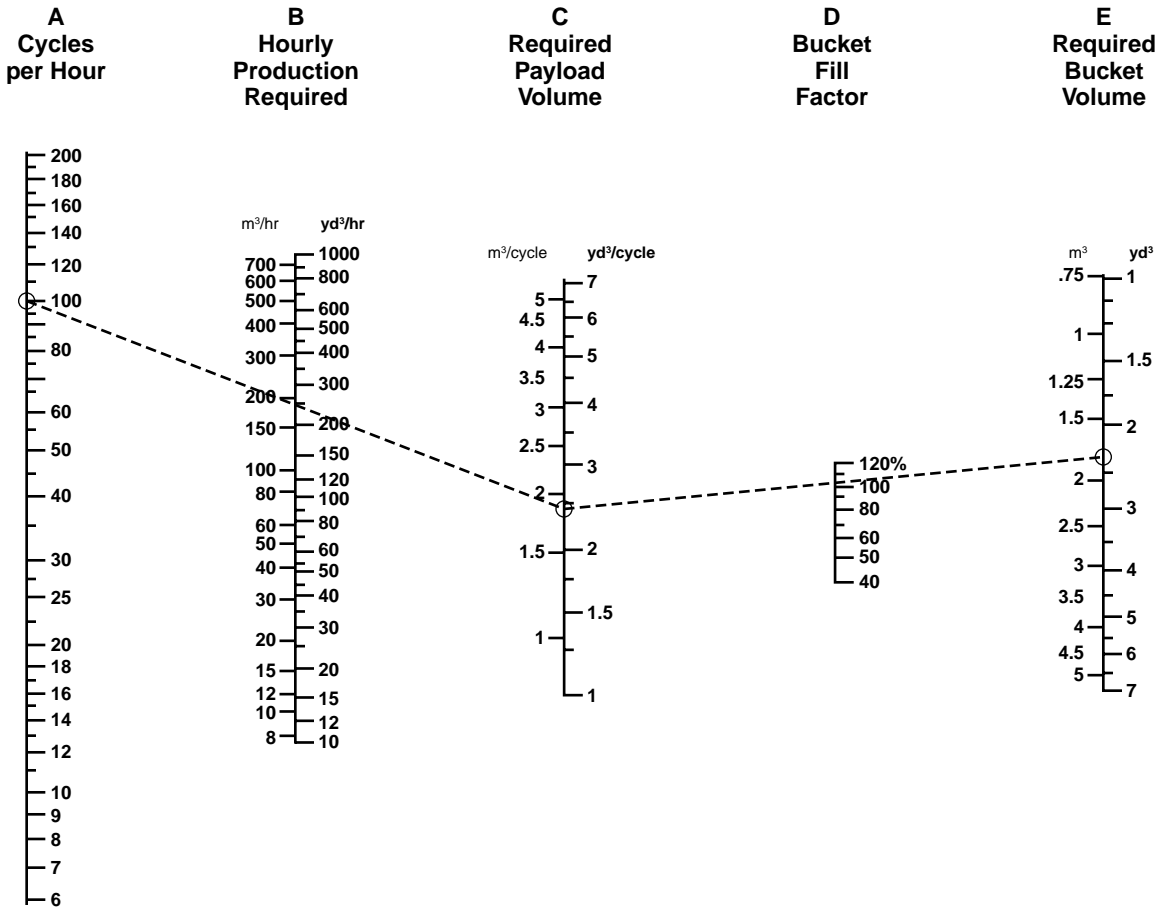

Track Loaders

Production and Machine Selection Nomograph

- To find payload weight for stability and output in tons per hour

- 5) Connect C 1.8 m³ (2.35 yd³) to F 1600 kg/m³ (2700 lb/yd³) and extend to G to find payload weight 2880 kg (6345 lb).
- 6) Compare G bucket payload weight 2880 kg (6345 lb) with maximum operating capacities table in this section to see if the 1.75 m³ (2.25 yd³) bucket can handle the desired payload. Table indicates the

953C with a 1.75 m³ (2.25 yd³) bucket equipped with bolt-on cutting edge or teeth and segments has a greater operating capacity of 3097 kg (6827 lb), therefore stability is okay.

- 7) Extend Scale A (100) to Scale I to find tons per hour 288 metric ton/hr (317 U.S. ton/hr).

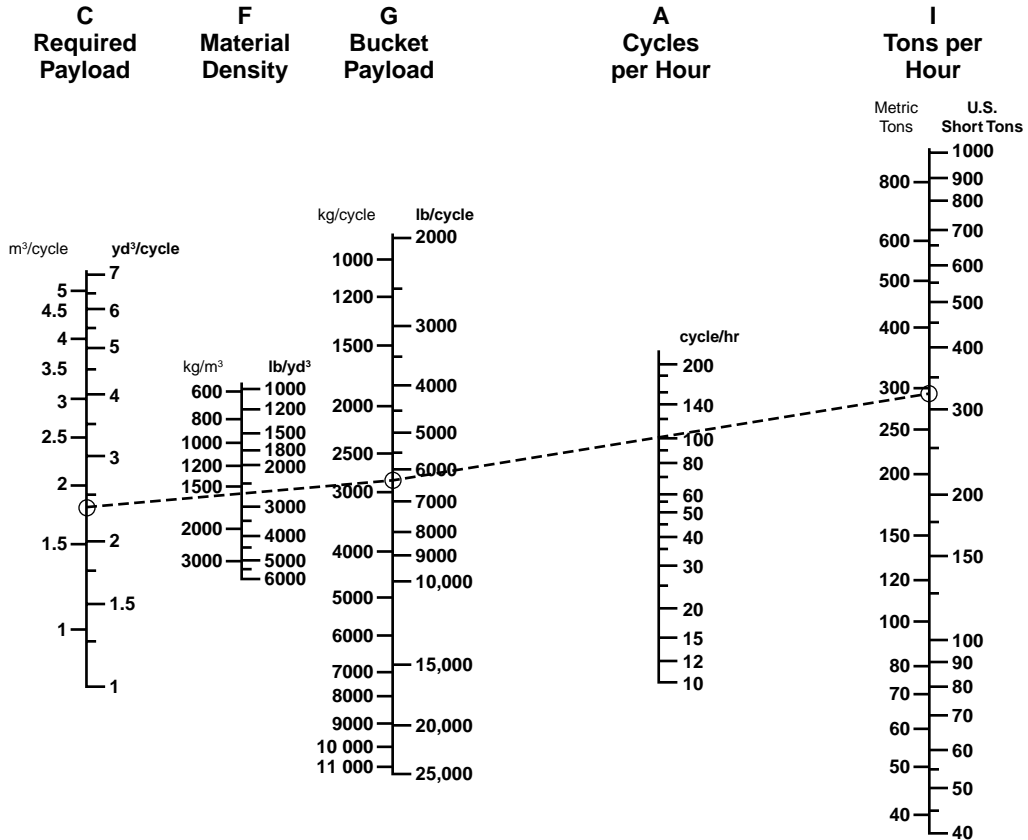

TRAVEL TIME CHARTS

Conditions:

- No grades.
- Speeds loaded and empty essentially the same.
- Bucket position constant during travel.
- Travel encountered in maneuver time portion of cycle not included.
- Acceleration time accounted for in maneuver time.

Travel Time (in minutes) =

Metric – $\frac{\text{number of meters traveled}}{\text{speed (in km/h)} \times 16.67}$

English – $\frac{\text{number of feet traveled}}{\text{speed (in mph)} \times 88}$

Hydrostatic top speed both forward and reverse 9 km/h (5.6 mph).

933C

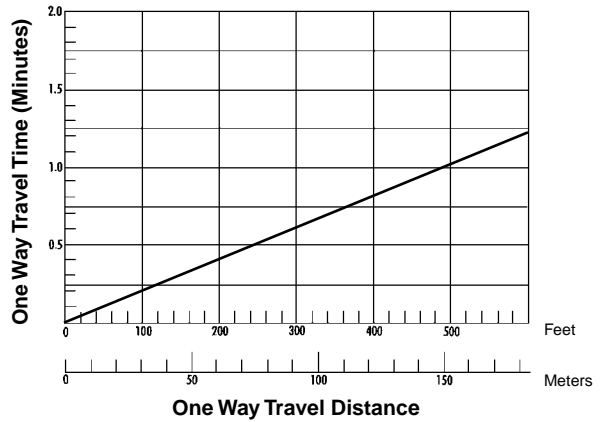

939C

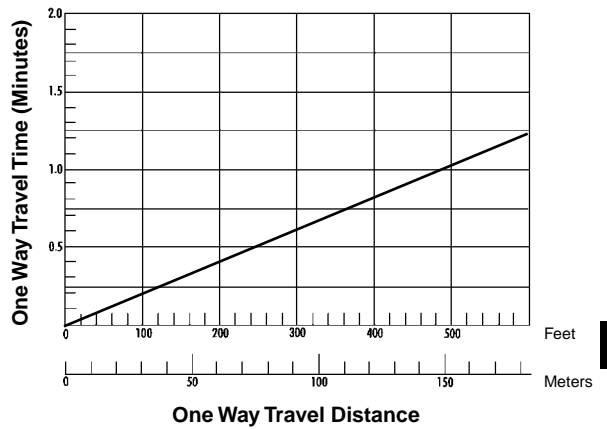

953C

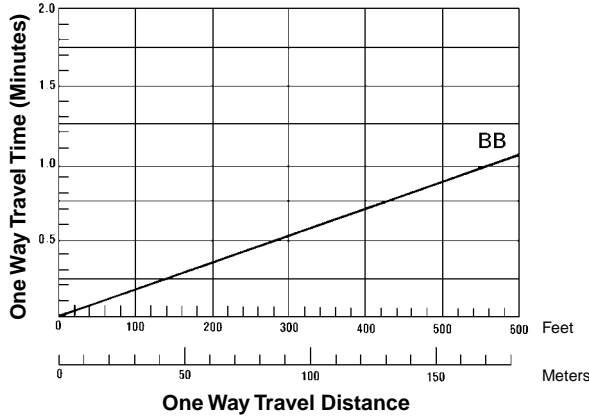

963B

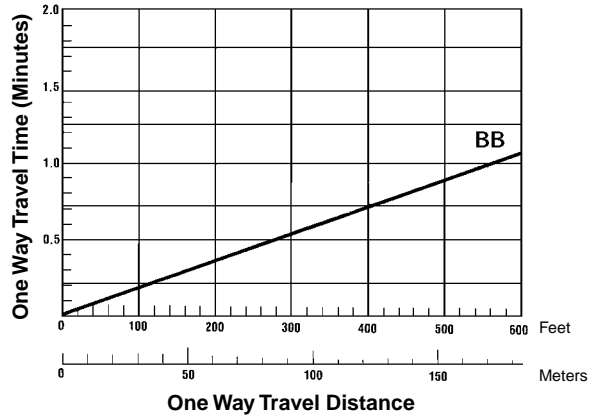

973

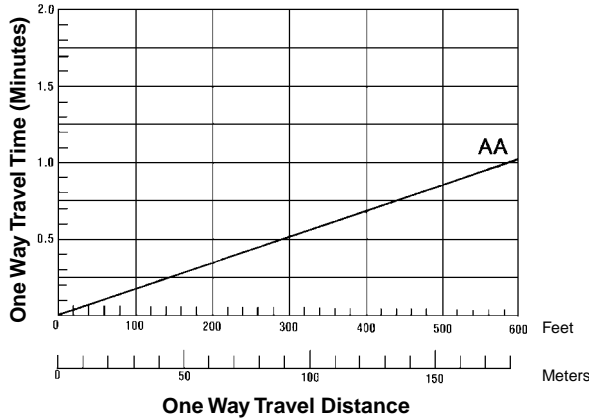

TRAVEL TIME CHARTS

Conditions:

- No grades.
- Speeds loaded and empty essentially the same.
- Bucket position constant during travel.
- Travel encountered in maneuver portion of cycle not included.
- Acceleration time accounted for in maneuver time.

Travel Time (in minutes) =

$$\text{Metric} - \frac{\text{number of meters traveled}}{\text{speed (in km/h)} \times 16.67}$$

$$\text{English} - \frac{\text{number of feet traveled}}{\text{speed (in mph)} \times 88}$$

KEY

AA — Hydrostatic top speed both forward and reverse
10.3 km/h (6.4 mph)

BB — Hydrostatic top speed both forward and reverse
10 km/h (6 mph)

Production Estimating Table
 • m^3 or $yd^3/60$ min. hour
 • Estimated bucket payload in bank m^3 or yd^3

Track Loaders

Bucket Size (m^3 or yd^3)		1.0	1.5	2.0	2.5	3.0	3.5	4.0	4.5	5.0
Cycle Time Hundredths of a minute	Cycles Per Hr	Unshaded area indicates average work range								
		0.25	240	240	360	480	600	720	840	960
0.30	200	200	300	400	500	600	700	800		
0.35	171	171	257	342	428	513	599	684	769	
0.40	150	150	225	300	375	450	525	600	675	750
0.45	133	133	200	268	332	400	466	530	600	665
0.50	120	120	180	240	300	360	420	480	540	600
0.55	109	109	164	218	272	328	382	436	490	545
0.60	100	100	150	200	250	300	350	400	450	600
0.65	92	92	138	184	230	276	322	368	416	460

WASTE HANDLING TRACK LOADERS

CONTENTS

Features	13-25
Specifications	13-26
Attachments	13-27

Features

- **Unmatched versatility** — excavates, loads, dozes, compacts, shreds, sorts, grapples — a true all purpose machine.
- **Additional heavy duty guarding** helps protect sheet metal and machine components from damage in waste handling applications.
- **Improved serviceability** — swing open doors, guards and oil coolers give quicker access for cleaning debris and for servicing.
- **Hinged heavy duty radiator guard** with quick release “T” handles allows for easy access to the radiator for cleaning.
- **Rear Striker Bar (optional)** keeps trash from climbing the track and damaging fenders.
- **Lamp Guard Group (front and rear)** protects lamps with bolt on grid guards.
- **Single grouser trapezoidal-shaped center hole track shoes (optional)** provides maximum traction and center holes allow sprocket to punch out dirt and debris.
- **Debris Barrier Package** protects machine from material entering engine and other compartments.

Waste Handling Track Loaders

Specifications



MODEL	953C WHA		963B WHA		973 WHA	
Flywheel Power	90 kW	121 hp	119 kW	160 hp	157 kW	210 hp
Operating Weight	15 840 kg	34,920 lb	21 269 kg	46,898 lb	29 266 kg	64,585 lb
Engine Model	3116T		3116TA		3306T	
Rated Engine RPM	2200		2200		2200	
Bore	105 mm	4.13"	105 mm	4.13"	121 mm	4.75"
Stroke	127 mm	5"	127 mm	5"	152 mm	6"
No. Cylinders	6		6		6	
Displacement	6.6 L	403 in ³	6.6 L	403 in ³	10.5 L	638 in ³
Speeds Forward,	km/h	mph	km/h	mph	km/h	mph
1st	0-10	0-6.2	0-10.1	0-6	0-10.3	0-6.4
2nd	Infinitely		Infinitely		Infinitely	
3rd	Variable		Variable		Variable	
Reverse						
1st	0-10	0-6.2	0-10.1	0-6	0-10.3	0-6.4
2nd	Infinitely		Infinitely		Infinitely	
3rd	Variable		Variable		Variable	
Hydraulic Cycle Time, Bucket Empty, in Seconds:						
Raise	6.7		6.2		7.4	
Dump	1.4		1.3		1.4	
Lower (Empty, Float Down)	3		2.3		2.6	
Total	11.1		9.8		11.4	
Track Rollers (Each Side)	6		6		7	
Width of Standard Track Shoe	380 mm	15"	450 mm	17.7"	500 mm	1'7.7"
Length of Track on Ground	2.295 m	7'6"	2.454 m	8'1"	2.85 m	9'6"
Ground Contact Area (With Std. Shoe)	1.74 m ²	2704 in ²	2.21 m ²	3426 in ²	2.92 m ²	4526 in ²
Ground Pressure	89 kPa	12.9 psi	96.2 kPa	13.7 psi	100.2 kPa	14.3 psi
Ground Clearance	377 mm	14.8"	439 mm	17"	456 mm	17.9"
Track Gauge	1.80 m	5'11"	1.85 m	6'0.8"	2.08 m	6'10"
Width Without Bucket	2.18 m	7'2"	2.30 m	7'6.5"	2.58 m	8'5.6"
Fuel Tank Refill Capacity	241 L	63.6 U.S. gal	296 L	78 U.S. gal	356 L	94 U.S. gal
Hydraulic System Refill Capacity	65 L	17.2 U.S. gal	68 L	18 U.S. gal	60 L	16 U.S. gal

See Wheel Loader section of this book for summary of S.A.E. Guidelines for Loader Specifications, to which Caterpillar adheres.

LANDFILL BUCKETS

Machine Model	953C		963B		973	
Bucket Model	B53-4L		B63-6L		B73-8L	
Capacity, rated (Refuse)	2.7 m ³	3.5 yd³	4.2 m ³	5.5 yd³	5.58 m ³	7.25 yd³
Capacity, rated (Earth)	1.91 m ³	2.5 yd³	2.87 m ³	3.75 yd³	4.2 m ³	5.5 yd³
Width	2438 mm	8'0"	3033 mm	9'11"	3323 mm	10'11"
Height	1448 mm	4'9"	1967 mm	6'5"	2284 mm	7'6"
Depth	889 mm	2'11"	1585 mm	5'2"	1626 mm	5'4"
Teeth-optional	8		8		8	
Clearance @ 45° dump	2852 mm	9'3"	2769 mm	9'1"	2918 mm	9'7"
Reach @ 45° dump	810 mm	2'8"	1406 mm	4'7"	1560 mm	5'1"
Digging depth	132 mm	5.2"	124 mm	4.9"	114 mm	4.5"
Weight (approx.)	998 kg	2200 lb	2475 kg	5460 lb	2905 kg	6400 lb

**MUTLI-PURPOSE
LANDFILL BUCKETS**

Machine Model	953C		963B		973	
Bucket Model	B53-3ML		B63-4ML		B73-6ML	
Capacity, rated (Refuse)	2 m ³	2.62 yd³	2.7 m ³	3.5 yd³	4.4 m ³	5.75 yd³
Capacity, rated (Earth)	1.53 m ³	2 yd³	1.9 m ³	2.5 yd³	2.68 m ³	3.5 yd³
Width	2426 mm	8'0"	2529 mm	8'4"	3399 mm	11'2"
Height	1676 mm	5'6"	1905 mm	6'3"	1968 mm	6'6"
Depth	953 mm	3'2"	1060 mm	3'6"	1243 mm	4'1"
Teeth-optional	8		8		8	
Clearance @ 45° dump	2738 mm	9'0"	2870 mm	9'5"	3121 mm	10'3"
Reach @ 45° dump	806 mm	2'8"	1013 mm	3'4"	1220 mm	4'0"
Digging depth	229 mm	9"	203 mm	8"	211 mm	8.3"
Weight (approx.)	1615 kg	3565 lb	2109 kg	4650 lb	2765 kg	6100 lb

Work Tools	973	963B	953C	939C*	933C*
Quick coupler	X	X	X		
General purpose bucket	X	X	X		
Landfill bucket	X	X	X		
Landfill Multi-purpose	X	X	X		
Skeleton rock bucket		X			
Coal bucket			X		
Woodchip bucket					
Fertilizer bucket					
Multi-purpose bucket	X	X	X		
Side dump bucket	X	X			
Demolition bucket	X				
Trim blade	X	X	X		
Straight blade			X		
Manual angle blade			X		
Hydraulic angle blade			X		
Fork	X	X	X		
Material handling arm	X	X	X		
Loader rake		X	X		

*This list is not all-inclusive. Contact Caterpillar Attachment Products and Services for specific attachment needs.

INTEGRATED TOOLCARRIERS

CONTENTS

Features	14-1
Specifications	14-2
Special attachments	14-4
Performance Data:	
General purpose buckets	14-5
Pallet forks	14-7
Material handling arm	14-8
Machine Dimensions:	
General purpose buckets	14-9
Pallet forks	14-10
Material handling arm	14-11
Bucket selection guide	14-13
Machine/Attachment selection	14-14

Features:

- **Integral quick coupler** for fast tool changes.
- **Wide range of tools** available to meet many jobs.
- **Increased lift height and reach** over conventional loaders.
- **Parallel lift** from ground level to maximum height.
- **High tilt force** throughout lift cycle provides exceptional load control.
- **Pressure compensating valves** provide precise hydraulic “feel” on the IT28G.
- **Transmission neutralizer lockout switch** for low speed maneuverability is standard. (IT14G-IT38G)
- **Positive carry position** for load stability and retention.
- **Standard third valve and optional fourth function** for multiple tool functions.
- **Work tool interchangeability.** IT14G thru IT28G share the same tools. IT38G and IT62G can share the same tools.
- **Excellent center visibility** to quick coupler and work tool.
- **Two position return** to work kickouts.



MODEL	IT14G		IT24F	
Flywheel Power	67 kW	90 hp	78 kW	105 hp
Engine Model	3054T		3114T	
Rated Engine RPM	2200		2400	
Bore	100 mm	3.94"	105 mm	4.13"
Stroke	127 mm	5"	127 mm	5"
No. Cylinders	4		4	
Displacement	4 L	244 in³	4.4 L	268 in³
Speeds Forward:	km/h	mph	km/h	mph
1st	7.0	Lo* 4.3	7.1	4.4
2nd	20.0	Hi* 12.4	13.1	8.2
3rd	9.0	Lo** 5.6	23.6	14.8
4th	32.0	Hi** 19.9	38.2	23.9
Speeds Reverse:				
1st	7.0	Lo* 4.3	7.1	4.4
2nd	20.0	Hi* 12.4	13.1	8.2
3rd	9.0	Lo** 5.6	23.6	14.8
4th	32.0	Hi** 19.9	—	
Hydraulic Cycle Time, rated load in bucket:	Seconds		Seconds	
Raise	6.9		5.3	
Dump	2.5		1.5	
Lower (empty, float down)	3.1		4.3	
Total	12.5		11.1	
Fuel tank capacity	150 L	39.6 U.S. gal	157 L	41.5 U.S. gal
Hydraulic tank capacity	70 L	18.5 U.S. gal	53 L	14 U.S. gal
Hydraulic system capacity (includes tank)	100 L	26.4 U.S. gal	79 L	20 U.S. gal

*Hydrostatic transmission standard speed version.

**Hydrostatic transmission high speed version.



MODEL	IT28G		IT38G		IT62G	
Flywheel Power	93 kW	125 hp	108 kW	145 hp	149 kW	200 hp
Engine Model	3116T		3126T		3126TA	
Rated Engine RPM	2300		2200		2200	
Bore	105 mm	4.13"	110 mm	4.3"	110 mm	4.3"
Stroke	127 mm	5"	127 mm	5"	127 mm	5"
No. Cylinders	6		6		6	
Displacement	6.6 L	403 in ³	7.2 L	439 in ³	7.2 L	439 in ³
Speeds Forward:	km/h	mph	km/h	mph	km/h	mph
1st	7.6	4.7	7.0	4.3	6.9	4.3
2nd	12.0	7.5	12.7	7.9	12.7	7.9
3rd	24.6	15.3	21.9	13.6	22.3	13.9
4th	36.7	22.8	35.9	22.3	37.0	23.0
Speeds Reverse:						
1st	7.6	4.7	7.0	4.3	7.6	4.7
2nd	12.0	7.5	12.7	7.9	13.9	8.7
3rd	24.6	15.3	21.9	13.6	24.5	15.3
4th	—	—	—	—	40.5	25.3
Hydraulic Cycle Time, rated load in bucket:	Seconds		Seconds		Seconds	
Raise	6.1		5.8		6.3	
Dump	1.4		2.0		2.2	
Lower (empty, float down)	2.8		2.9		2.2	
Total	10.3		10.7		10.7	
Fuel tank capacity	230 L	60.8 U.S. gal	254 L	67 U.S. gal	295 L	78 U.S. gal
Hydraulic tank capacity	70 L	18.5 U.S. gal	55 L	14.5 U.S. gal	88 L	23.3 U.S. gal
Hydraulic system capacity (includes tank)	125 L	33 U.S. gal	90 L	23.8 U.S. gal	153 L	40.4 U.S. gal

BUCKETS

General Purpose — for most material types with choice of cutting edges and teeth.

Loose Material — designed for snow, woodchips, hay, coal, etc. Add independently controlled top clamp for materials like hay, brush, silage or compost.

Multi-purpose — versatile ... loads, strips top-soil, bulldozes, clamps pipe, cleans up debris, plus many other tasks.

High dump or “roll-out” — for extended dump height of light materials.

Side dump — dump forward or to the left ... ideal in close quarters or to reduce turning time.

Grading — long, flat floor and straight edge for finish work in housing developments, concrete pours, landscaping and light dozing.

Grab and Grip — positive clamping jaws for garbage pickup, snow removal, debris cleanup or any loose or bundled loads.

FORKS

Log or lumber forks — with optional clamps, single, double or full-width.

Wide frame forks — adjustable for control of long pipes, culverts, etc.

Stinger fork — with long single shaft to penetrate salvage autos or round hay bales.

Utility pallet forks — for a variety of tasks, with three different tine sizes.

Pulpwood — choice of single or double top clamp for positive control of material.

Sorting — designed for durability and efficiency in stacking operations.

BLADES

Angling dozer — choice of manual or hydraulic angling 25° left or right.

Straight blade — for spreading, leveling and other utility dozing.

One-way snow blade — economical snow clearing with minimal machine effort.

V-plow — excellent for breaking up large drifts or high speed clearing operations.

Material Handling arm — carries and places pipe, prefabricated building panels and handles bulky, nonpalletized material ... two telescopic sections extend for three position operation.

AND MORE ...

Rotary broom — for street cleanup, snow removal, jobsite clean-up, clearing runways ... angles left or right 30°.

Asphalt cutter — aids repair work on roads, pavements, water and sewer mains ... cuts clean to 125 mm (5").

Hooks — for attachment to dumpsters, bins, troughs, etc., to permit quick, easy, instant movement from place to place.

These products are available through Caterpillar Attachment Products and Services.

Balderson Work Tools

Work Tools	IT62G	IT38G	IT28G	IT24F	IT14G
Light Material Bucket		X	X	X	X
Fertilizer Bucket				X	X
Bucket With Top Clamp		X	X	X	X
Grab and Grip Bucket		X	X	X	X
Multi-Purpose Bucket	X	X	X	X	X
Side Dump Bucket	X	X	X	X	X
High Dump Bucket			X	X	X
Pallet Fork	X	X	X	X	X
Log/Lumber Fork	X	X	X	X	X
Core Fork			X	X	X
Straight Blade			X	X	X
Manual Angle Blade		X	X	X	X
Hydraulic Angle Blade			X	X	X
Manual Reversible Plow	X	X	X	X	X
Hydr. Reversible Plow	X	X	X	X	X
V-Plow			X	X	X
One Way Plow			X	X	X
Asphalt Cutter			X	X	X
Hydraulic Broom	X	X	X	X	X
Hydraulic Hammers			X	X	X
Tire Loader	X		X	X	X
Loader Rake		X	X	X	X
Woodchip	X	X	X	X	X
Refuse		X	X	X	X

This list not all inclusive. Contact Caterpillar Attachment Products and Services for special attachment needs.

Operating Specifications — Buckets

	IT14G		IT24F		IT28G		IT38G		IT62G	
Cutting Edge	Corner Guard or Bolt-on Edge									
Capacity, heaped	1.3 m ³	1.7 yd³	1.6 m ³	2 yd³	2 m ³	2.6 yd³	2.5 m ³	3.25 yd³	3.1 m ³	4 yd³
Capacity, struck	1.1 m ³	1.4 yd³	1.4 m ³	1.8 yd³	1.7 m ³	2.25 yd³	2.1 m ³	2.7 yd³	2.7 m ³	3.5 yd³
Width	2401 mm	7'10.5"	2395 mm	7'10"	2549 mm	8'4"	2708 mm	8'10"	2870 mm	9'5"
Dump clearance @ full lift and 45° discharge	2920 mm	9'7"	2752 mm	9'0"	2911 mm	9'7"	2800 mm	9'2"	2840 mm	9'4"
Reach at 45° discharge angle, 2130 mm/7'0" clearance	1425 mm	4'8"	1547 mm	5'8"	1567 mm	5'2"	1657 mm	5'5"	***	
Reach at full lift and 45° discharge	787 mm	2'7"	1088 mm	3'7"	1014 mm	3'4"	1200 mm	3'11"	1242 mm	4'11"
Reach with arms horizontal and bucket level	2150 mm	7'1"	2374 mm	7'10"	2383 mm	7'10"	2521 mm	8'3"	2775 mm	9'1"
Digging depth	175 mm	6.9"	132 mm	5.2"	108 mm	4.3"	70 mm	2.8"	88 mm	3.5"
Overall length	6424 mm	21'1"	6771 mm	22'3"	7318 mm	24'0"	7487 mm	24'7"	8263 mm	27'1"
Overall height (bucket @ full raise)	4801 mm	15'9"	4855 mm	15'11"	5080 mm	16'8"	5237 mm	17'2"	5436 mm	17'10"
Loader clearance circle (bucket in carry position)	10.4 m	34'1"	10.76 m	35'4"	11.36 m	37'4"	12.13 m	39'10"	***	
Static tipping load**										
Straight	5307 kg	11,675 lb	6091 kg	13,431 lb	8469 kg	18,674 lb	8861 kg	19,535 lb	13 014 kg	28,631 lb
Full turn	4588 kg	10,094 lb	5284 kg	11,651 lb	7335 kg	16,124 lb	7621 kg	16,802 lb	11 288 kg	24,834 lb
Breakout force*	7850 kg	17,270 lb	8813 kg	19,433 lb	10 631 kg	23,441 lb	12 650 kg	27,830 lb	13 280 kg	29,216 lb
Operating weight**	7861 kg	17,294 lb								
4 forward, 3 reverse	—		9915 kg	21,863 lb	11 970 kg	26,394 lb	13 062 kg	28,714 lb	—	
4 forward, 4 reverse	—		—		—		—		18 284 kg	40,225 lb

*Breakout force is measured 102 mm (4") behind tip of cutting edge with bucket hinge pin as pivot in accordance with SAE J732 JUN92.

**Operating Weight and static tipping load include lubricants, full fuel tank, ROPS cab and 80 kg (176 lb) operator.

— IT14G includes high speed version, standard counterweight and 17.5R25 tires.

— IT24F includes 17.5-25, 12 PR tires.

— IT28G includes 20.5-25, 12 PR (L-2) tires and optional counterweight.

— IT38G includes 20.5R25, XTLA (L-2) tires.

Machine stability is affected by the tire size, tire ballast and attachments.

***Information unavailable.

Operating Specifications — Buckets

Cutting Edge	IT14G		IT24F		IT28G		IT38G	
	Bolt-on Teeth							
Capacity, heaped	1.2 m ³	1.6 yd³	1.5 m ³	2 yd³	1.9 m ³	2.5 yd³	2.4 m ³	3.1 yd³
Capacity, struck	1 m ³	1.3 yd³	1.3 m ³	1.70 yd³	1.6 m ³	2.1 yd³	2 m ³	2.6 yd³
Width	2424 mm	7'11.4"	2424 mm	7'11.4"	2532 mm	8'4"	2735 mm	8'11"
Dump clearance @ full lift and 45° discharge	2975 mm	9'9"	2640 mm	8'8"	2799 mm	9'2"	2720 mm	8'11"
Reach at 45° discharge angle, 2130 mm/7'0" clearance	1351 mm	4'5"	1579 mm	5'2"	1605 mm	5'3"	1704 mm	5'7"
Reach at full lift and 45° discharge	757 mm	2'6"	1183 mm	3'11"	1109 mm	3'8"	1288 mm	4'3"
Reach with arms horizontal and bucket level	2090 mm	6'10"	2520 mm	8'3"	2529 mm	8'4"	2640 mm	8'8"
Digging depth	156 mm	6.1"	146 mm	5.7"	122 mm	4.8"	45 mm	1.8"
Overall length	6506 mm	21'4"	6894 mm	22'7"	7442 mm	24'5"	7601 mm	24'11"
Overall height (bucket @ full raise)	4801 mm	15'9"	4855 mm	15'11"	5080 mm	16'8"	5237 mm	17'2"
Loader clearance circle (bucket in carry position)	10.47 m	34'4"	10.87 m	35'8"	11.46 m	37'6"	12.23 m	40'1"
Static tipping load**								
Straight	5400 kg	11,880 lb	6169 kg	13,603 lb	8567 kg	18,890 lb	9059 kg	20,037 lb
Full turn	4675 kg	10,285 lb	5356 kg	11,810 lb	7423 kg	16,370 lb	7806 kg	17,209 lb
Breakout force*	8438 kg	18,564 lb	9446 kg	20,828 lb	11 340 kg	25,000 lb	12 738 kg	28,024 lb
Operating weight**	7819 kg	17,202 lb	—	—	—	—	—	—
4 forward, 3 reverse	—	—	9900 kg	21,830 lb	11 945 kg	26,340 lb	12 967 kg	28,527 lb
4 forward, 4 reverse	—	—	—	—	—	—	—	—

*Breakout force is measured 102 mm (4") behind tip of cutting edge with bucket hinge pin as pivot in accordance with SAE J732 JUN92.

**Operating Weight and static tipping load include lubricants, full fuel tank, ROPS cab and 80 kg (176 lb) operator.

— IT14G includes high speed version, standard counterweight and 17.5R25 tires.

— IT24F includes 17.5-25, 12 PR tires.

— IT28G includes 20.5-25, 12 PR tires and optional counterweight.

— IT38G includes 20.5R25 XTLA (L-2) tires.

Machine stability is affected by the tire size, tire ballast and attachments.

Operating Specifications — Pallet Forks

	IT14G		IT24F		IT28G	
Fork tine length	1050 mm	3'5"	1050 mm	3'5"	1050 mm	3'5"
Ground to top of tine clearance	3708 mm	12'2"	3629 mm	11'11"	3843 mm	12'7"
Reach with arms horizontal and forks level	1490 mm	4'11"	1584 mm	5'2"	1513 mm	5'0"
Overall length	6723 mm	22'1"	6939 mm	22'9"	7407 mm	24'4"
Static tipping load*						
Straight	4267 kg	9387 lb	4952 kg	10,919 lb	7126 kg	15,713 lb
Full turn	3700 kg	8140 lb	4327 kg	9541 lb	6212 kg	13,697 lb
Operating weight*						
4 forward, 3 reverse	7715 kg	16,973 lb	9588 kg	21,142 lb	11 550 kg	25,470 lb

The rated operating load for a machine with pallet fork is: SAE J1197 FEB91; 50% of full turn static tipping load, or hydraulic/ structural limit. CEN 474-3: 60% of full turn static tipping load on rough terrain; 80% of full turn static tipping load on firm and level ground, or the hydraulic/ structural limit.

	IT14G		IT24F		IT28G		IT38G		IT62G	
Fork tine length	1200 mm	3'11"	1200 mm	3'11"	1200 mm	3'11"	1219 mm	4'0"	1219 mm	4'0"
Ground to top of tine clearance	3708 mm	12'2"	3629 mm	11'11"	3843 mm	12'7"	3716 mm	12'2"	3792 mm	12'5"
Reach with arms horizontal and forks level	1490 mm	4'11"	1584 mm	5'2"	1513 mm	5'0"	2891 mm	9'6"	1976 mm	6'6"
Overall length	6873 mm	22'7"	7089 mm	23'3"	7557 mm	24'10"	7826 mm	25'8"	8756 mm	28'9"
Static tipping load*										
Straight	4133 kg	9093 lb	4934 kg	10,879 lb	6922 kg	15,263 lb	7196 kg	15,830 lb	8928 kg	19,642 lb
Full turn	3582 kg	7880 lb	4309 kg	9501 lb	6032 kg	13,300 lb	6218 kg	13,680 lb	7753 kg	17,057 lb
Operating weight*										
4 forward, 3 reverse	7732 kg	17,010 lb	9605 kg	21,179 lb	11 570 kg	25,510 lb	12 470 kg	27,390 lb	—	—
4 forward, 4 reverse	—	—	—	—	—	—	—	—	17 663 kg	38,859 lb

	IT14G		IT24F		IT28G	
Fork tine length	1350 mm	4'5"	1350 mm	4'5"	1350 mm	4'5"
Ground to top of tine clearance	3708 mm	12'2"	3629 mm	11'11"	3843 mm	12'7"
Reach with arms horizontal and forks level	1490 mm	4'11"	1584 mm	5'2"	1513 mm	5'0"
Overall length	7023 mm	23'1"	7239 mm	23'9"	7707 mm	25'3"
Static tipping load*						
Straight	4008 kg	8818 lb	4918 kg	10,844 lb	6729 kg	14,837 lb
Full turn	3471 kg	7636 lb	4293 kg	9466 lb	5862 kg	12,296 lb
Operating weight*						
4 forward, 3 reverse	7745 kg	17,010 lb	9618 kg	21,208 lb	11 580 kg	25,580 lb

*Static tipping load and operating weight include lubricants, full fuel tank, ROPS cab and 80 kg (176 lb) operator.

— IT14G includes high speed version, standard counterweight and 17.5R25 tires.

— IT24F includes 17.5-25, 12 PR tires.

— IT28G includes 20.5-25, 12 PR tires and optional counterweight.

— IT38G includes 20.5R25 XTLA (L-2) tires.

Machine stability and operating weight are affected by tire size, tire ballast and other attachments.

Operating Specifications — Material Handling Arm The rated operating load for a machine with material handling arm is 50% of full turn static tipping load, or the hydraulic/structural limit.

	IT14G		IT24F		IT28G		IT38G		IT62G	
Handling Arm Position	Retracted									
Operating load — Full articulation	1292 kg	2842 lb	1576 kg	3475 lb	2528 kg	5574 lb	2049 kg	4508 lb	3085 kg	6795 lb
Static tipping load* Straight	2981 kg	6558 lb	3605 kg	7949 lb	5055 kg	11,146 lb	4746 kg	10,441 lb	7095 kg	15,548 lb
Full turn	2585 kg	5678 lb	3151 kg	6948 lb	4407 kg	9717 lb	4098 kg	9016 lb	6170 kg	13,590 lb
Operating weight* 4 forward, 3 reverse	7600 kg	16,720 lb	9473 kg	21,483 lb	11 440 kg	25,220 lb	12 380 kg	27,200 lb	—	
4 forward, 4 reverse	—		—		—		—		17 506 kg	38,583 lb

	IT14G		IT24F		IT28G		IT38G		IT62G	
Handling Arm Position	Mid-position									
Operating load — Full articulation	1015 kg	2233 lb	1245 kg	2745 lb	1747 kg	3852 lb	1729 kg	3804 lb	2626 kg	5783 lb
Static tipping load* Straight	2345 kg	5159 lb	2852 kg	6289 lb	4011 kg	8844 lb	4009 kg	8820 lb	6017 kg	13,253 lb
Full turn	2031 kg	4486 lb	2490 kg	5490 lb	3494 kg	7704 lb	3457 kg	7605 lb	5251 kg	11,565 lb
Operating weight* 4 forward, 3 reverse	7600 kg	16,720 lb	9473 kg	21,483 lb	11 440 kg	25,220 lb	12 380 kg	27,200 lb	—	
4 forward, 4 reverse	—		—		—		—		17 506 kg	38,583 lb

	IT14G		IT24F		IT28G		IT38G		IT62G	
Handling Arm Position	Extended									
Operating load — Full articulation	837 kg	1841 lb	1031 kg	2273 lb	1449 kg	3195 lb	1492 kg	3282 lb	2288 kg	5040 lb
Static tipping load* Straight	1936 kg	4259 lb	2362 kg	5208 lb	3327 kg	7336 lb	3463 kg	7619 lb	5240 kg	11,484 lb
Full turn	1675 kg	3685 lb	2062 kg	4547 lb	2898 kg	6390 lb	2983 kg	6563 lb	4576 kg	10,080 lb
Operating weight* 4 forward, 3 reverse	7600 kg	16,720 lb	9473 kg	21,483 lb	11 440 kg	25,220 lb	12 380 kg	27,200 lb	—	
4 forward, 4 reverse	—		—		—		—		17 506 kg	38,583 lb

*Static tipping load and operating weight include lubricants, full fuel tank, ROPS cab and 80 kg (176 lb) operator.

— IT14G includes high speed version, standard counterweight and 17.5R25 tires.

— IT24F includes 17.5-25, 12 PR tires.

— IT28G includes 20.5-25, 12 PR tires and optional counterweight.

— IT38G includes 20.5R25 XTLA (L-2) tires.

Machine stability and operating weight are affected by tire size, tire ballast and other attachments.

Machine Dimensions

- with General Purpose Buckets and Bolt-on Cutting Edge

Integrated Toolcarriers

See rating plate on each tool. Plate shows the effect of using the same tools on different size machines and aids in machine tool selection. Each plate states capabilities of standard machine in terms of capacity. Any significant weight change of attachments can adversely affect these ratings.

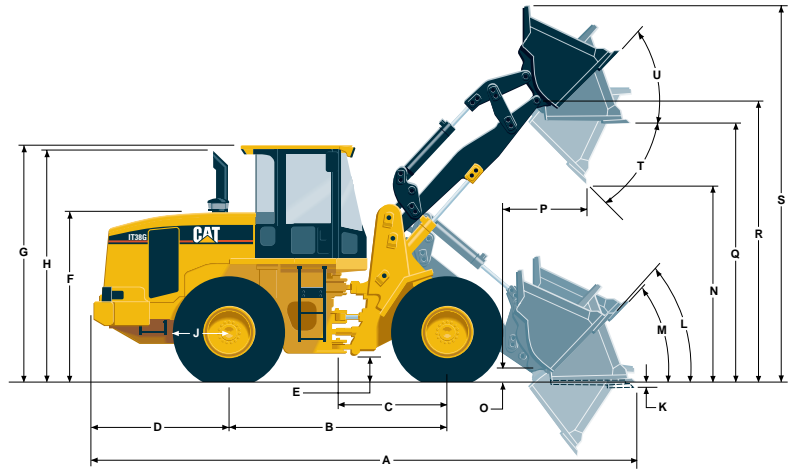

MODEL	IT14G		IT24F		IT28G		IT38G		IT62G	
Bucket	1.3 m ³	1.7 yd ³	1.6 m ³	2 yd ³	2 m ³	2.6 yd ³	2.5 m ³	3.25 yd ³	3.1 m ³	4 yd ³
A Maximum Overall Length	6424 mm	21'1"	6771 mm	22'3"	7318 mm	24'0"	7487 mm	24'7"	8263 mm	27'1"
B Wheel base	2600 mm	8'6"	2700 mm	8'10"	2900 mm	9'6"	3020 mm	9'11"	3350 mm	11'0"
C Machine center point to front axle	1300 mm	4'3"	1350 mm	4'5"	1450 mm	4'9"	1510 mm	4'11"	1675 mm	5'6"
D Rear axle to counterweight	1658 mm	5'5"	1667 mm	5'6"	1955 mm	6'7"	1907 mm	6'3"	1938 mm	6'4"
E Ground clearance	456 mm	18"	321 mm	12.6"	407 mm	16"	400 mm	16"	474 mm	18.7"
F Height to top of engine compartment	2080 mm	6'10"	2138 mm	7'0"	2149 mm	7'1"	2215 mm	7'3"	2254 mm	7'5"
G Height to top of ROPS	3100 mm	10'2"	3134 mm	10'4"	3268 mm	10'8"	3300 mm	10'10"	3374 mm	11'1"
H Height to top of stack	2255 mm	7'5"	3070 mm	10'1"	3184 mm	10'5"	3210 mm	10'6"	3224 mm	10'7"
J Tire radius (empty machine)	620 mm	2'0"	612 mm	2'0"	684 mm	2'3"	688 mm	2'3"	728 mm	2'5"
K Maximum Digging Depth (bucket level)	175 mm	6.9"	132 mm	5.2"	108 mm	4.3"	70 mm	2.8"	88 mm	3.5"
L Maximum rollback at carry height	54°		55°		56°		46.6°		50°	
M Maximum rollback at ground	49°		53°		53°		48.8°		44°	
N Dump Clearance at full lift and 45° Discharge Angle	2920 mm	9'7"	2752 mm	9'0"	2911 mm	9'7"	2800 mm	9'2"	2841 mm	9'4"
O Hinge pin Height at carry position	374 mm	15"	360 mm	14"	382 mm	15"	475 mm	18.7"	*	
P Reach at full lift and 45° Dump	787 mm	2'7"	1088 mm	3'7"	1014 mm	3'4"	1200 mm	3'11"	1242 mm	4'11"
Q Clearance Level Bucket at full height	3565 mm	11'8"	3506 mm	11'6"	3694 mm	12'1"	3625 mm	11'11"	3742 mm	12'3"
R Maximum Hinge Pin Height	3798 mm	12'6"	3766 mm	12'4"	3980 mm	13'1"	3930 mm	12'11"	4106 mm	13'6"
S Maximum Overall Height	4801 mm	15'9"	4855 mm	15'11"	5080 mm	16'8"	5237 mm	17'2"	5436 mm	17'10"
T Full Dump at Maximum Lift	48°		49°		48°		45°		45°	
U Maximum roll back at Maximum Lift	57°		53°		55°		44.6°		58°	
Tires	17.5R25		17.5-25		20.5-25		20.5R25		23.5-25	

*Information unavailable.

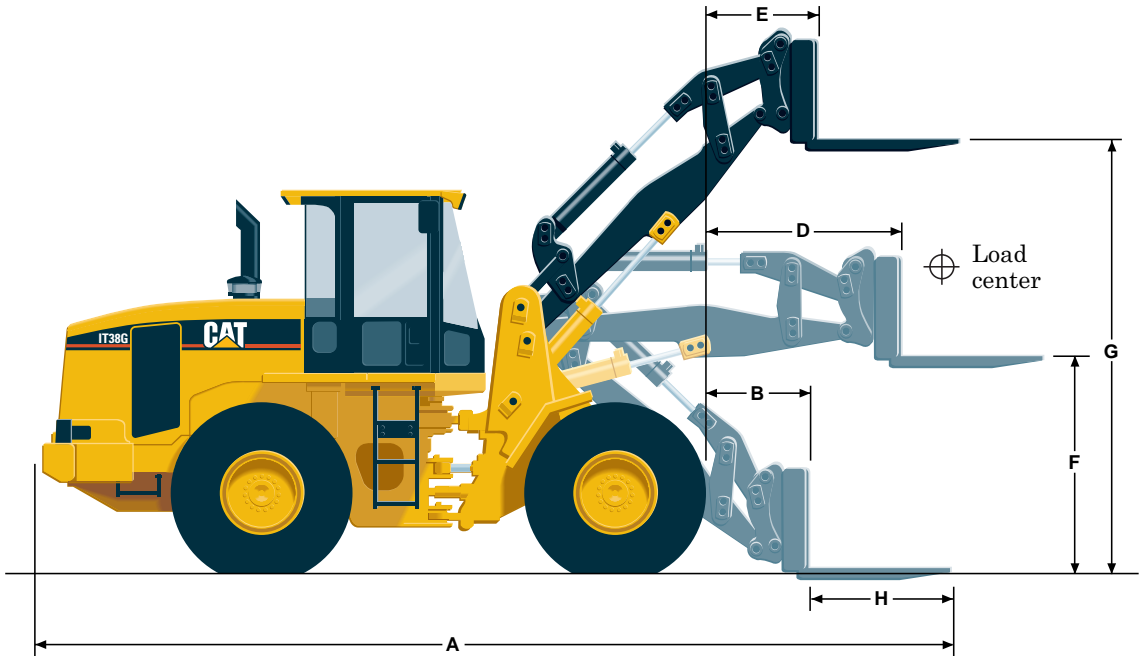

MODEL	IT14G		IT24F		IT28G		IT38G		IT62G	
Rated Operating Load										
Per SAE J1197	1791 kg	3940 lb	2155 kg	4738 lb	3016 kg	6650 lb	—	—	—	—
Per CEN 474-3 Rough Terrain	2149 kg	4728 lb	2585 kg	5688 lb	3619 kg	7980 lb	—	—	—	—
Per CEN 474-3 Firm level ground	2865 kg	6303 lb	3447 kg	7584 lb	4826 kg	10,640 lb	—	—	—	—
A Maximum Overall Length	6873 mm	22'7"	7089 mm	23'3"	7557 mm	24'10"	7826 mm	25'8"	8756 mm	28'9"
B Reach with forks at ground level	745 mm	2'5"	852 mm	2'10"	750 mm	2'6"	955 mm	3'2"	1446 mm	4'9"
C Load center	600 mm	2'0"	600 mm	2'0"	600 mm	2'0"	600 mm	2'0"	610 mm	2'0"
D Reach with arms horizontal and forks level	1490 mm	4'11"	1584 mm	5'2"	1513 mm	5'0"	1672 mm	5'6"	1976 mm	6'6"
E Reach with fork at maximum height	586 mm	1'11"	836 mm	2'9"	703 mm	2'4"	946 mm	3'1"	1117 mm	3'8"
F Arms horizontal & forks level	1808 mm	5'11"	1831 mm	6'0"	1923 mm	6'4"	1864 mm	6'1"	1738 mm	5'8"
G Ground to top of tine at maximum height	3708 mm	12'2"	3629 mm	11'11"	3843 mm	12'7"	3716 mm	12'2"	3792 mm	12'5"
H Fork Tine Length	1200 mm	3'11"	1200 mm	3'11"	1200 mm	3'11"	1219 mm	4'0"	1219 mm	4'0"
Tires	17.5R25		17.5-25		20.5-25		20.5R25		23.5-25	

Machine Dimensions
 ● with Material Handling Arm

Integrated Toolcarriers

For IT14G, IT24F and IT28G machines equipped with 15.5 25 L-2 tires subtract 39 mm (1.5") from lift height — add 39 mm (1.5") for below ground measurements — add 42 mm (1.7") for all reach measurements.

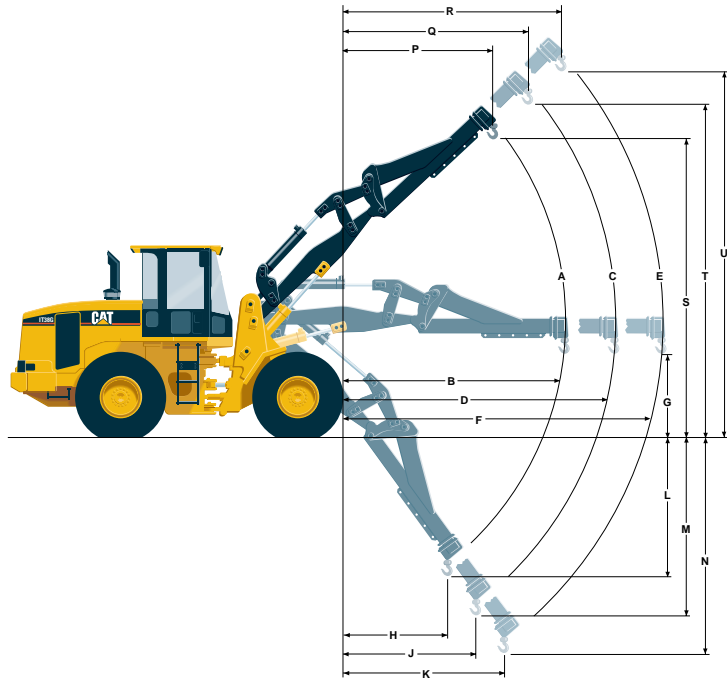

MODEL	IT14G		IT24F		IT28G	
A Operating load (retracted) @ full articulation	1292 kg	2842 lb	1576 kg	3475 lb	2528 kg	5574 lb
B Reach horizontal (retracted)	3179 mm	10'5"	3285 mm	10'7"	3187 mm	10'5"
C Operating load (mid-position) @ full articulation	1015 kg	2233 lb	1245 kg	2745 lb	1747 kg	3852 lb
D Reach horizontal (mid-position)	4178 mm	13'8"	4257 mm	14'0"	4986 mm	13'9"
E Operating load (extended) @ full articulation	837 kg	1841 lb	1031 kg	2273 lb	1449 kg	3195 lb
F Reach horizontal (extended)	5178 mm	17'0"	5257 mm	17'3"	5186 mm	17'0"
G Clearance horizontal	1585 mm	5'2"	1607 mm	5'4"	1983 mm	6'6"
H Reach full down (retracted)	1514 mm	4'11"	1646 mm	5'5"	1529 mm	5'0"
J Reach full down (mid-position)	2116 mm	6'11"	2257 mm	7'5"	2122 mm	7'0"
K Reach full down (extended)	2719 mm	8'11"	2869 mm	9'5"	2715 mm	8'11"
L Clearance full down (retracted)	1874 mm	6'2"	1786 mm	5'10"	1502 mm	4'11"
M Clearance full down (mid-position)	2670 mm	8'9"	2576 mm	8'6"	2306 mm	7'8"
N Clearance full down (extended)	3468 mm	11'5"	3367 mm	11'1"	3111 mm	10'2"
P Reach at maximum height (retracted)	1402 mm	4'7"	1783 mm	5'10"	1608 mm	5'3"
Q Reach at maximum height (mid-position)	1962 mm	6'5"	2396 mm	7'10"	2199 mm	7'3"
R Reach at maximum height (extended)	2522 mm	8'2"	3009 mm	9'11"	2791 mm	9'2"
S Clearance at maximum height (retracted)	5185 mm	17'0"	5039 mm	16'6"	5578 mm	18'3"
T Clearance at maximum height (mid-position)	6012 mm	19'9"	5828 mm	19'1"	6379 mm	20'11"
U Clearance at maximum height (extended)	6840 mm	22'5"	6617 mm	21'9"	7185 mm	23'7"
Tires	17.5R25		17.5-25		20.5-25	

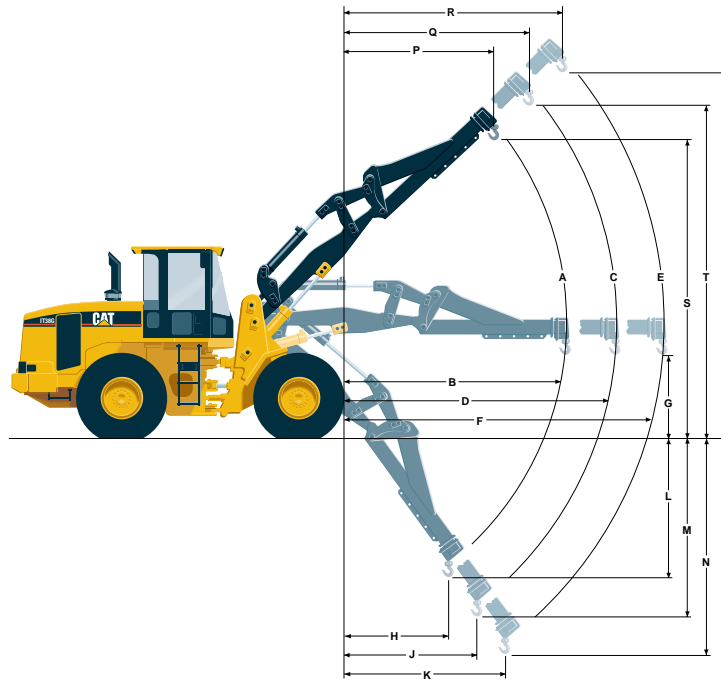

MODEL	IT38G		IT62G*	
A Operating load (retracted) @ full articulation	2049 kg	4508 lb	3085 kg	6795 lb
B Reach horizontal (retracted)	3816 mm	12'6"	4002 mm	13'2"
C Operating load (mid-position) @ full articulation	1729 kg	3804 lb	2626 kg	5783 lb
D Reach horizontal (mid-position)	4616 mm	15'2"	4802 mm	15'9"
E Operating load (extended) @ full articulation	1492 kg	3282 lb	2288 kg	5040 lb
F Reach horizontal (extended)	5416 mm	17'9"	5602 mm	18'5"
G Clearance horizontal	1562 mm	5'1"	1817 mm	6'0"
H Reach full down (retracted)	1840 mm	6'0"	2720 mm	8'11"
J Reach full down (mid-position)	2309 mm	7'7"	3354 mm	11'0"
K Reach full down (extended)	2777 mm	9'1"	3987 mm	13'1"
L Clearance full down (retracted)	2282 mm	7'6"	1483 mm	4'10"
M Clearance full down (mid-position)	2930 mm	9'7"	1971 mm	6'6"
N Clearance full down (extended)	3580 mm	11'9"	2460 mm	8'1"
P Reach at maximum height (retracted)	2506 mm	8'3"	2546 mm	8'4"
Q Reach at maximum height (mid-position)	3076 mm	10'1"	3109 mm	10'2"
R Reach at maximum height (extended)	3646 mm	11'11"	3672 mm	12'1"
S Clearance at maximum height (retracted)	5296 mm	17'5"	5774 mm	18'11"
T Clearance at maximum height (mid-position)	5857 mm	19'3"	6342 mm	20'10"
U Clearance at maximum height (extended)	6419 mm	21'1"	6910 mm	22'8"
Tires	20.5R25		23.5-25	

*All dimensions are to lift eye.

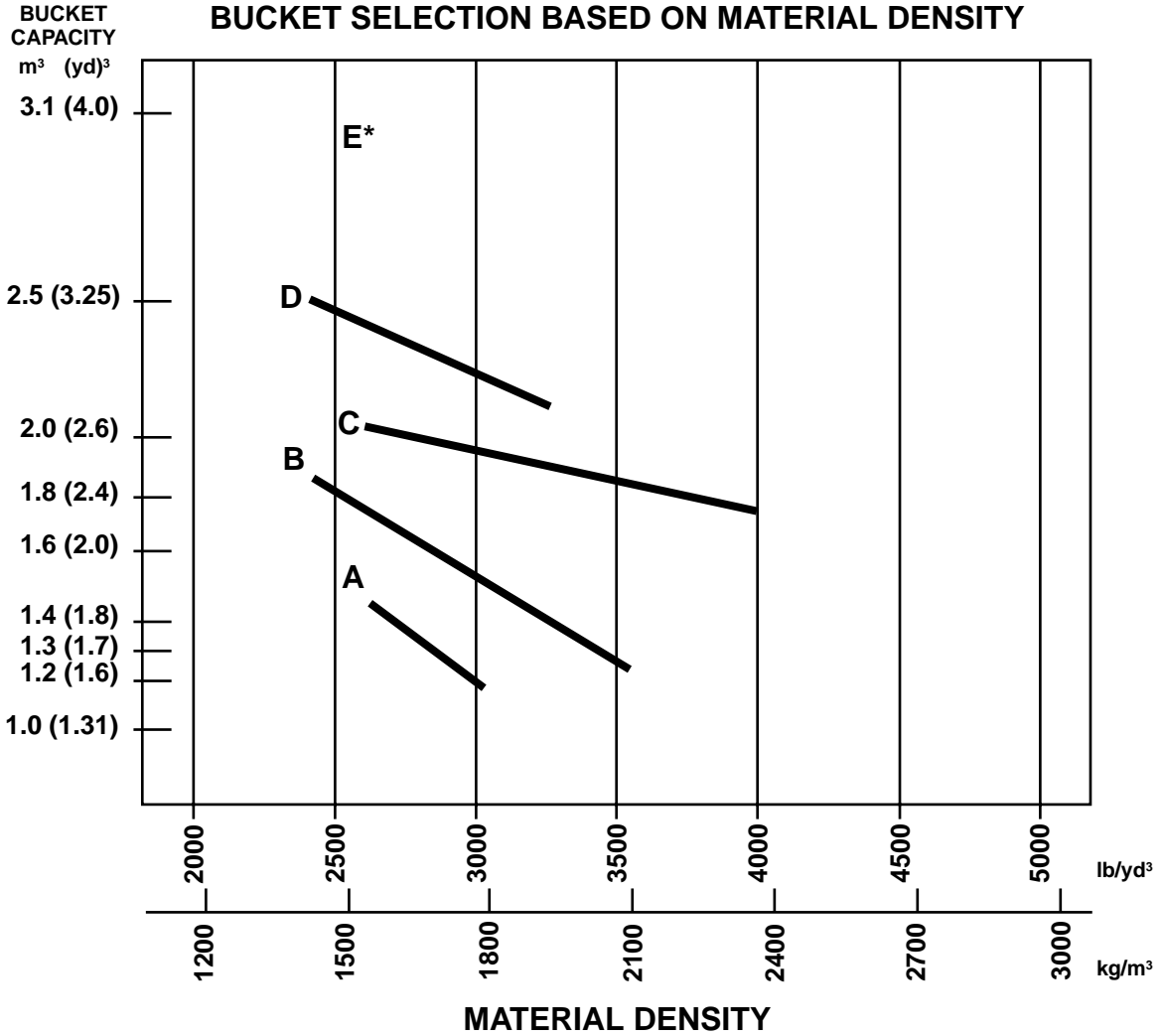

NOTE: Machines equipped same as those on Performance Data pages.

KEY

- A — IT14G
- B — IT24F
- C — IT28G
- D — IT38G
- E — IT62G Information unavailable

MACHINE/ATTACHMENT SELECTION

The Integrated Toolcarrier’s versatility and the wide range of attachments makes the “single machine fleet” concept highly attractive to an increasing number of users.

A Job Analysis helps identify applications, work requirements, material handling parameters and the current working method. Thoroughly research each element in the following chart, the gathered information will help select the proper Integrated Toolcarrier System.

JOB ANALYSIS METHOD

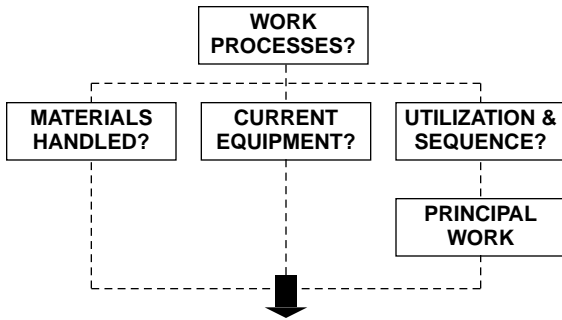

- **APPROPRIATE INTEGRATED TOOLCARRIER MODEL SIZE**
- **NECESSARY ATTACHMENTS**

Work Processes:

The first step in the job analysis is to identify all work processes from start to finish. Key questions outlined below will begin to indicate the required attachments and potential Integrated Toolcarrier applications.

- What kinds of work are performed: (e.g., dozing, loading, stacking, digging, sweeping, handling special materials, etc.)
 - ... in site preparation?
 - ... below ground level?
 - ... at ground level?
 - ... above ground level?
 - ... in landscaping?
 - ... in maintenance equipment yard?
 - etc.
- What work is done manually that could be done with an Integrated Toolcarrier?
- What are the work conditions?:
 - ... underfoot?
 - ... grades?
 - ... tight quarters?
 - ... time restraints?
 - ... climate?
 - etc.

Materials Handled:

Examining the materials handled will assist in determining necessary attachments. Sizes and weights of material(s) handled will indicate the appropriate Integrated Toolcarrier model by defining lift and reach requirements. Concentrate on the material flow at the job site — the point of origin as well as the final destination for the various materials will undoubtedly have material handling requirements.

- What kinds of materials are handled (e.g. snow, earth, bricks, chemicals, pipe, logs, etc.)
- What form are the materials handled in: bulk? palletized?
- How much does each weigh?
- What are the dimensions of each?
- What are the... movement parameters:
 - ... dozed what distance?
 - ... load and carried what distance?
 - ... lifted how high?
 - ... placed below ground level?
 - ... placed what distance from machine?

Current Equipment:

If determining material weight is not possible, much information can be determined from looking at the current equipment fleet. This will suggest required performance capabilities such as lifting capacity.

- Machines currently doing the work (e.g. wheel loaders, lift trucks, sweepers, light capacity cranes, snow plows, etc.)?
- What special (maximum) capabilities does each machine have (production, lift height, load capacity, width/height dimensions, reach, turning radius, travel speed, etc.)?
- To what extent are each machine's maximum capabilities used?
- What are owning/operating costs of each?

Utilization & Sequence:

Utilization implies how often the current machines are used and what will be the utilization factors for the Integrated Toolcarrier with each individual attachment. Sequence implies what order these tasks are accomplished in and if two or more machines operate at the same time. This portion of the job analysis should assist in comparing economies of various systems. Other important considerations may be the number of operators needed, storage space, reduced maintenance requirements, etc.

- How often (what percent) is each machine used?
- How often and when does it sit idle?
- How often and when do two or more machines work at the same time?
- Can the operation be changed to permit single machine operation?

Principal Work:

Utilization and sequence will indicate the principal work the Integrated Toolcarrier will do, further assisting in attachment and model sizing and selection. The basic machine/tool package should be able to handle the toughest, most frequently performed jobs for the primary application. Secondary tools can have a little more "give and take" in their performance capabilities than the primary tool.

- What work can be accomplished by an Integrated Toolcarrier?
- What work will take up the majority of Integrated Toolcarrier time?
- What work will use the maximum static tipping capabilities of the Integrated Toolcarrier?
- What high cost (owning and operating) and/or low utilization machines can be replaced by an Integrated Toolcarrier?

Additional Tips for Tool Sizing and Selection

Tool selection will principally concern hydraulic power requirements and static tipping load considerations. The standard tools offered by Caterpillar can be used on any Integrated Toolcarrier machine with little difficulty. However, tools such as the hydraulic broom, claws, blades and asphalt cutter will require additional consideration before proposing a system to the customer.

Rating Plates

The Caterpillar tools have rating plates showing rated or recommended load limits for each machine in standard configuration. These rated loads are determined by structural limitations on the tool and/or hydraulic and stability criteria established for each machine. The IT14G thru IT28G share common attachment points and can share attachments. The IT38G and IT62G can share the same attachments. This ability to interchange tools necessitates the need for rating plates.

Shown below are examples of the rating plates that will be found on each Caterpillar tool. Beginning with the IT14G, the rating plate on each tool will refer the user to the Operation and Maintenance Manual for the rated operating load for that tool on a specific machine model.

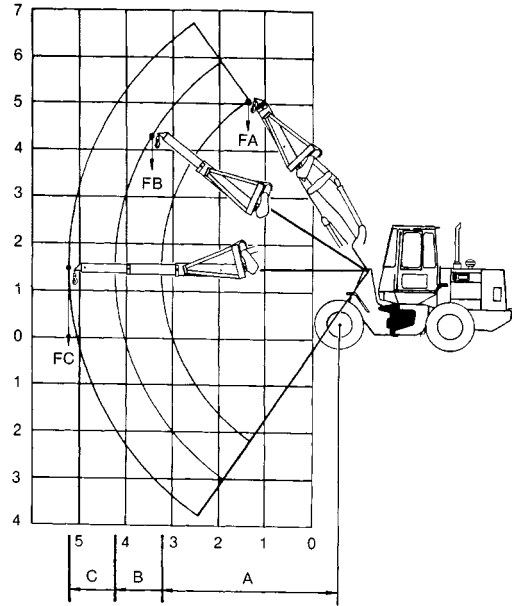

Material Handling Arm

Part No. 9V1795

Table indicates rated load at standard vehicle configuration. See operator's manual to determine rated load for vehicle configuration being used.

Model	Load Radius								Rated Load			
	A		FA		B		FB		C		FC	
	m	ft	kg	lb	m	ft	kg	lb	m	ft	kg	lb
IT14G	3.85	12.6	1292	2842	4.85	15.9	1015	2233	5.85	19.2	837	1841
IT24F	3.92	12.8	1554	3426	4.92	16.2	1220	2690	5.92	19.5	960	2117
IT28G	3.93	12.9	2528	5574	4.97	16.3	1747	3852	5.94	19.5	1449	3195
IT38G	4.57	15.0	4098	9016	5.37	17.7	3457	7605	6.17	20.3	2983	6563
IT62G	4.81	15.8	6170	13,590	5.61	18.4	5251	11,565	6.41	21.0	4576	10,080

Fork Rating Plate

(Located on back of carriage, left side)

Table indicates rated pallet fork load at standard machine configuration with 1200 mm (3'11") fork tine length and a load center distance of 600 mm (24"), see operator manual to determine rated load for vehicle configuration being used.

Model	kg	lb	Model	kg	lb
IT14G	1791	3940	IT24F	2147	4723
IT28G	2867	6321			

Bucket Rating Plate

(Located left rear of buckets)

Bucket capacity, SAEJ742 FEB85 (nominally heaped)

Table indicates rated load at vehicle configuration noted by the asterisks. See operator manual to determine rated load for vehicle configuration being used.

Part No. 112-3121 — 1.4 m³ (1.75 yd³) w/Bolt-On Cutting Edge

Model	kg	lb
IT14G*	2273	5000
IT24F**	2680	5909

Part No. 132-2257 — 1.6 m³ (2.1 yd³) w/Bolt-On Cutting Edge

Model	kg	lb
IT24F**	2642	5825

Part No. 132-2256 — 1.8 m³ (2.35 yd³) w/Bolt-On Cutting Edge

Model	kg	lb
IT24F**	2614	5746
IT28G***	3708	8176

Part No. 132-2258 — 2.0 m³ (2.6 yd³) w/Bolt-On Cutting Edge

Model	kg	lb
IT28G***	3667	8087

*Specifications shown are for high-speed version IT14G and include lubricants, full fuel tank, ROPS cab, 80 kg (176 lb) operator, standard 250 kg (550 lb) counterweight and 17.5-R25 (L2 equivalent) tires.

**Specifications shown include lubricants, full fuel tank, ROPS cab, 80 kg (176 lb) operator and 17.5 x 25, 12 PR (L2) tires.

***Specifications shown include optional counterweight, standard lubricants, full fuel tank, ROPS cab, 80 kg (176 lb) operator and 20.5-25, 12 PR (L2) tires.

The bucket rating plate can be used to illustrate the attachment sizing and selection process. The charts explain each machine's maximum payload. The maximum material density would be determined by dividing the payload by the bucket capacity. If the actual material density exceeds the recommended material density, the process should be repeated to select the properly sized bucket.

A similar procedure would be used with the forks and material handling arm to determine maximum recommended lifting capacity and/or required IT model size.

Pallet Fork

The pallet fork will fulfill many material handling needs. A modified Class 3 fork carriage provides visibility to the tines for precision pallet work. This carriage with non-standard spacing accepts many Class 3 lift truck attachments.

Pallet fork rated operating loads are based on the following:

SAE J1197 FEB91: 50% of the full turn static tipping load or the hydraulic/structural limitations.

CEN 474-3 (European standard): 60% of the full static tipping load on rough terrain or the hydraulic/structural limitations. 80% of the full turn static tipping load on firm, level ground or the structural/hydraulic limitation. Other local, regional or international guidelines may also apply.

If operation is on rough ground these criteria may need modification. In this instance, the size and rating of existing equipment should be considered.

Sizing for pallet work generally consists of answering the following questions.

1. What are the average loaded pallet dimensions?
2. Lift Capacity — what capacity is required to lift and move the average pallet load? The maximum pallet load?
3. Lift Height — can the machine reach the top level of the standard pallet stack? What are the maximum reach, lift and height requirements?
4. Maneuverability — can the machine work around the current aisle configuration? In the stacking aisles? Main aisles? Intersecting aisles? Are 90° turns required in any aisle for material placement?
5. Length — what tine length is required to fit the commonly used pallets? (1219 mm [48 in] tines are standard length for most palletized material.)
6. Any machine height restrictions?
7. Any special fork configurations required?

Lift capacity, lift height, aisle configuration and tine length are the most important considerations in recommending a pallet handling machine.

Example problem:

The following example applies the job analysis method to a work situation.

Sewer & Water Contractor

Sets water lines (152 mm-610 mm [6 in-24 in] iron pipe), sanitary sewer lines (152 mm-457 mm [6 in-18 in] PVC) and storm sewer lines (610 mm-1067 mm [24 in-42 in] concrete pipe) primarily in urban areas ... often-times across or down existing streets.

Materials

Loam/Clay: 1600 kg/m³ (2700 lb/yd³) loose density Bedding

(Gravel): 1900 kg/m³ (3200 lb/yd³) loose density

Water Pipe: 610 mm (24 in) push-on joint ductile iron, 6.1 m (20 ft) sections, 1309 kg (2885 lb)
215 kg/m (144.3 lb/ft) × 6.1 m (20 ft)
See trenching pages in the Excavator backhoe section.

Storm Sewer: 1067 mm (42 in), Wall B, concrete pipe, 1.5 m (5 ft) sections, 1556 kg (3430 lb) 1021 kg/m (686 lb/ft × 5 ft)
See trenching pages in the Excavator backhoe section.

Manhole

Boxes: 1361 kg (3000 lb)

WHAT INTEGRATED TOOLCARRIER MODEL SHOULD BE RECOMMENDED?

WHICH ATTACHMENTS?

Work Processes	Integrated Toolcarrier Attachment Possibilities
Bundled PVC and individual concrete/iron pipe-loaded/unloaded (yardsite) and strung along trench	Forks/Material Handling Arm
Unload, handle, set manhole boxes	Material Handling Arm
Excess excavated material truck loaded	Bucket
Bedding material handled/placed	Bucket
Trench backfilled	Bucket/Blade
Trench compaction	Compactor Wheel
Rough and finish grading	Bucket/Blade
Street cleanup	Bucket/Broom
Pavement removal	Rebar Snips/Asphalt Cutter

Current Equipment

Utilization

Cat 22590%
Champ CB607 lift truck, 3175 kg (7000 lb) capacity15%
Deere 444 with 1.1 m ³ (1.5 yd ³) G.P. bucket60%
Rosco D-50 sweeperone half hour/day
Rammax 1361 kg (3000 lb) self-propelled trench compactor25%

Machine sizing

1350 mm (53 in) Forks

Operating Load at Full Turn*

Model	kg	lb
IT14G	1735	3817
IT24F	2146	4722
IT28G	2931	6463
Water pipes: 1309 kg (2885 lb)		IT14G ... 1 pipe — no problem IT24F ... 1 pipe — no problem IT28G ... 1 pipe — no problem
Storm sewer pipes: 1556 kg (3430 lb)		IT14G ... 1 pipe — no problem IT24F ... 1 pipe — no problem IT28G ... 1 pipe — no problem

*Note that the most conservative operating load (SAE J1197 FEB91) is used here. The rated operating load for some competitive machines with pallet forks will be based upon European standard CEN 474-3, **assuming operation on firm and level ground** (i.e. using 80% of full turn static tipping load).

Material Handling Arm (MHA)

The rated load for the MHA is 50% of the full turn static tipping load in each position or hydraulic or structural limitations. Manually extendable telescopic sections enable maximum lifting capacity at the full retracted position, and maximum lift height and reach in the fully extended position.

Operating Load at Full Turn

Model	Retracted	Mid	Extended
IT14G	1292 kg	1015 kg	837 kg
	2542 lb	2233 lb	1841 lb
IT24F*	1576 kg	1245 kg	1031 kg
	3475 lb	2745 lb	2273 lb
IT28G	2528 kg	1747 kg	1449 kg
	5574 lb	3852 lb	3195 lb

Storm sewer pipes:
1556 kg (3430 lb)

IT14G ... no
IT24F ... marginal in retracted
IT28G ... yes in retracted and mid

Manhole boxes:
1361 kg (3000 lb)

IT14G ... no
IT24F ... yes in retracted
IT28G ... yes in retracted, mid and extended

Buckets

All general purpose buckets are interchangeable on IT14G-IT28G due to common attachment points on the quick couplers. Bucket selection will depend on the material density in your application. Offering multiple sized buckets allows the user the flexibility to closely match material density and bucket size with machine capability. Equipping a machine with too large a bucket will result in unacceptable stability — too small a bucket may provide inadequate tire coverage.

Bucket 1900 kg/m³ (3200 lb/yd³) ... 100% fill factor

Model	Bucket	Payload	50% Full Turn Static Tipping
IT24F*	1.4 m ³	2660 kg	2680 kg
	1.8 yd³	5852 lb	5896 lb
	1.6 m ³	3040 kg	2642 kg
	2.0 yd³	6688 lb	5812 lb
	1.8 m ³	3424 kg	2614 kg
IT28G	2.4 yd³	7680 lb	5750 lb
	1.8 m ³	3420 kg	3708 kg
	2.3 yd³	7524 lb	8176 lb
IT38G	2.0 m ³	3800 kg	3668 kg
	2.6 yd³	8360 lb	8087 lb
	2.3 m ³	3856 kg	3850 kg
	3.0 yd³	8500 lb	8488 lb

NOTE: Metric numbers are a product of conversion.
*IT24F and IT28G equipped with 17.5 × 25 tires.

Machine/Attachment Recommendation

IT28G — The greater static tipping load capabilities allow it to do a greater portion of the contractor's total work processes. With the following attachments, the IT28G could replace part or all of the specialty units, such as the wheel loader, rough terrain lift truck, street sweeper, and/or the trench compactor.

1.8 m³ (2.3 yd³), or 2.0 m³ (2.6 yd³) General Purpose Bucket

1350 mm (53 in) forks (handles all pipes)

Material Handling Arm — (handles pipe sizes under 1067 mm (42 in) concrete and manhole boxes ... 225 would have to set 1219 mm (48 in) and larger concrete pipe

Broom

Optional Attachments to Consider:

24-LH compactor wheel

Rebar snips

Asphalt cutter

TELESCOPIC HANDLERS



CONTENTS

Features	15-1
Specifications	15-1
Performance Data	15-3
Dimensions	15-11
Tire Selection	15-11
Attachments	15-12

Features:

- **Tough, reliable machine components** — Cat 3054 engine turbocharged on U.S. models, naturally aspirated on non-U.S. models. Powershift transmission, enclosed oil immersed brakes, differential lock on front axle and mechanical driveline. Variable displacement axial piston pump. Proven components and well protected from the perils of the jobsite.
- **High visibility factors** — include low boom pivot point, side mounted power module and close fitting fenders. Carefully profiled engine hood allows front wheel visibility. Low profile stabilizers on 3-section machines provides excellent forward visibility.
- **Excellent Operator Comfort** — with large spacious operator station. Open cab or deluxe closed cab with large glazed glass area. Single lever pilot operated boom control. Powershift transmission with 4 forward speeds, 3 reverse and transmission disconnect. Power assisted brakes and steering. Easy engine access for daily maintenance.
- **Superior Performance** — with low center of gravity, maximized wheel base. Fast, responsive hydraulic system with variable displacement axial piston pump. Front and rear overhang is minimized. Four wheel drive and steer with three steering modes, 2-wheel steer, circle steer and crab steer.

MODEL

TH62

Flywheel Power (Gross)	60 kW	81 hp
Turbocharged*	81 kW	109 hp
Operating Weight	6840 kg	15,080 lb
Engine Model	3054	
Rated Engine RPM	2200	
No. of Cylinders	4	
Bore	100 mm	3.94 in
Stroke	127 mm	5.00 in
Displacement	4.0 L	243 in ³
Speeds Forward:	km/h	mph
1st	6	4
2nd	11	7
3rd	22	14
4th	32	20
Speeds Reverse:		
1st	6	4
2nd	11	7
3rd	22	14
Turning Circle Radius	m	ft
Over Tires	3.63	11'11"
Over Forks	4.63	15'2"
Over Bucket	4.72	15'6"
Track	3.43	11'3"
Aisle Width		
Over Forks	3.84	12'7"
Over Bucket @ carry	3.94	12'11"
Tires	15.4 x 24	
Service Refill Cap:		
Fuel Tank @ 90% fill	120 L	32 U.S. gal
Hydraulic Tank	150 L	40 U.S. gal

*U.S. models only.



MODEL	TH63		TH82		TH83		TH103	
Flywheel Power (Gross)	60 kW	81 hp	60 kW	81 hp	81 kW	109 hp	81 kW	109 hp
Turbocharged*	81 kW	109 hp	81 kW	109 hp	Std		Std	
Operating Weight	9260 kg	20,420 lb	7470 kg	16,470 lb	10 000 kg	22,050 lb	11 360 kg	25,050 lb
Engine Model	3054		3054		3054T		3054T	
Rated Engine RPM	2200		2200		2200		2200	
No. of Cylinders	4		4		4		4	
Bore	100 mm	3.94 in	100 mm	3.94 in	100 mm	3.94 in	100 mm	3.94 in
Stroke	127 mm	5.00 in	127 mm	5.00 in	127 mm	5.00 in	127 mm	5.00 in
Displacement	4.0 L	243 in³	4.0 L	243 in³	4.0 L	243 in³	4.0 L	243 in³
Speeds Forward:	km/h	mph	km/h	mph	km/h	mph	km/h	mph
1st	6	4	6	4	6	4	6	4
2nd	11	7	11	7	11	7	11	7
3rd	22	14	22	14	22	14	22	14
4th	32	20	32	20	32	20	32	20
Speeds Reverse:								
1st	6	4	6	4	6	4	6	4
2nd	11	7	11	7	11	7	11	7
3rd	22	14	22	14	22	14	22	14
Turning Circle Radius	m	ft	m	ft	m	ft	m	ft
Over Tires	3.79	12'5"	3.79	12'5"	3.79	12'5"	4.19	13'9"
Over Forks	4.62	15'2"	4.62	15'2"	5.07	15'2"	5.61	18'5"
Over Bucket	4.71	15'5"	4.71	15'5"	5.24	17'2"	5.61	18'5"
Track	3.59	11'9"	3.59	11'9"	3.59	11'9"	3.86	12'8"
Aisle Width								
Over Forks	3.84	12'7"	3.84	12'7"	4.28	14'8"	4.75	15'7"
Over Bucket @ carry	3.94	12'11"	3.94	12'11"	4.45	14'7"	4.75	15'7"
Tires	15.5 x 25		15.5 x 24		13.0 x 25		14.0 x 24	
Service Refill Cap:								
Fuel Tank @ 90% fill	120 L	32 U.S. gal	120 L	32 U.S. gal	120 L	32 U.S. gal	140 L	37 U.S. gal
Hydraulic Tank	150 L	40 U.S. gal	150 L	40 U.S. gal	150 L	40 U.S. gal	170 L	45 U.S. gal

*U.S. models only.

- Performance Data
- Standard Forks and Carriage
- No Stabilizers

Telescopic Handlers

TH62
Non-U.S. Version

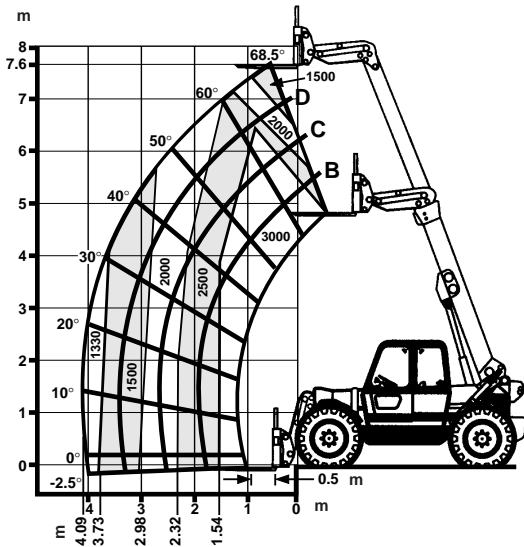

Numbers in chart measured in kilograms.

Maximum lift capacity	3000 kg	6615 lb
Maximum lift height	7.6 m	24'11"
Load at maximum height	1500 kg	3307 lb
Max. height at maximum load	6.5 m	21'4"
Max. reach at maximum load	1.54 m	5'1"
Maximum forward reach	4.09 m	13'5"
Load at maximum reach	1330 kg	2932 lb

TH62
North American Version

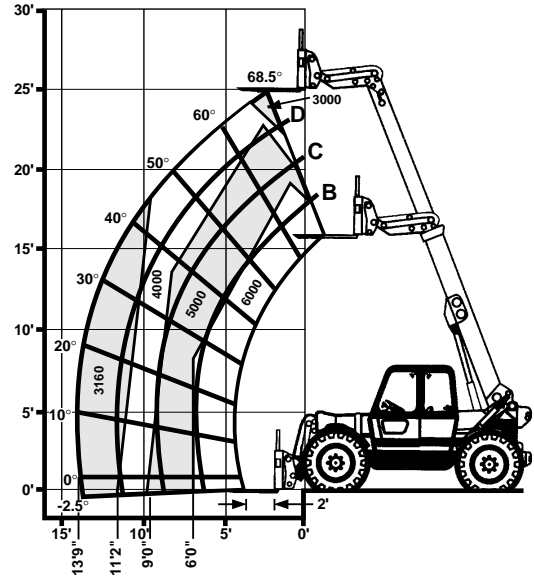

Numbers in chart measured in pounds.

Maximum lift capacity	2725 kg	6000 lb
Maximum lift height	7.6 m	25'0"
Load at maximum height	1365 kg	3000 lb
Maximum forward reach	4.2 m	13'9"
Load at maximum reach	1435 kg	3160 lb

Telescopic Handlers

- Performance Data
- Standard Forks and Carriage
- Non-U.S. Version

TH63
Stabilizers Up

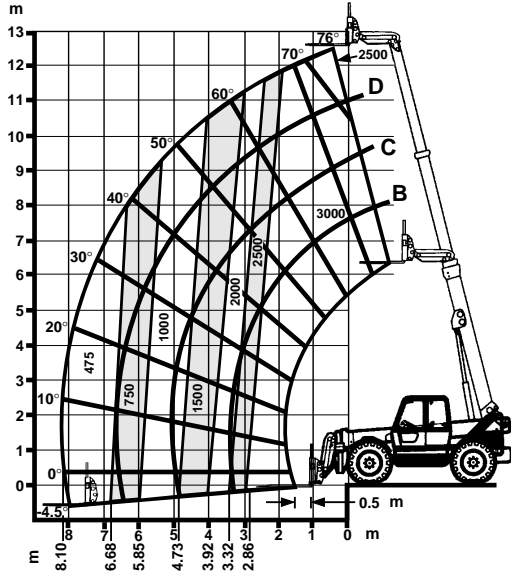

Numbers in chart measured in kilograms.

TH63
Stabilizers Down

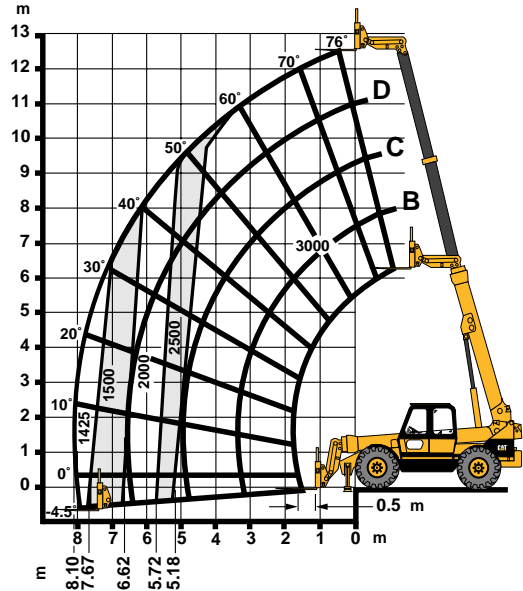

Numbers in chart measured in kilograms.

Maximum lift capacity	3000 kg	6615 lb
Maximum lift height	12.5 m	41'0"
Load at maximum height	2500 kg	5512 lb
Max. height at maximum load	12.0 m	39'4"
Max. reach at maximum load	2.86 m	9'5"
Maximum forward reach	8.10 m	26'7"
Load at maximum reach	475 kg	1047 lb

Maximum lift capacity	3000 kg	6615 lb
Maximum lift height	12.5 m	41'0"
Load at maximum height	3000 kg	6515 lb
Max. height at maximum load	12.5 m	41'0"
Max. reach at maximum load	5.18 m	17'0"
Maximum forward reach	8.10 m	26'7"
Load at maximum reach	1425 kg	3142 lb

- Performance Data
- Standard Forks and Carriage
- North American Version

Telescopic Handlers

TH63
No Stabilizers

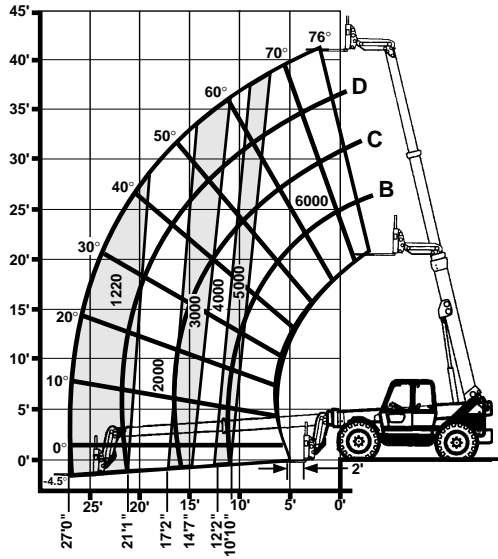

Numbers in chart measured in pounds.

Maximum lift capacity	2725 kg	6000 lb
Maximum lift height	12.5 m	41'0"
Load at maximum height	2725 kg	6000 lb
Maximum forward reach	8.2 m	27'0"
Load at maximum reach	554 kg	1220 lb

TH63
Stabilizers Down

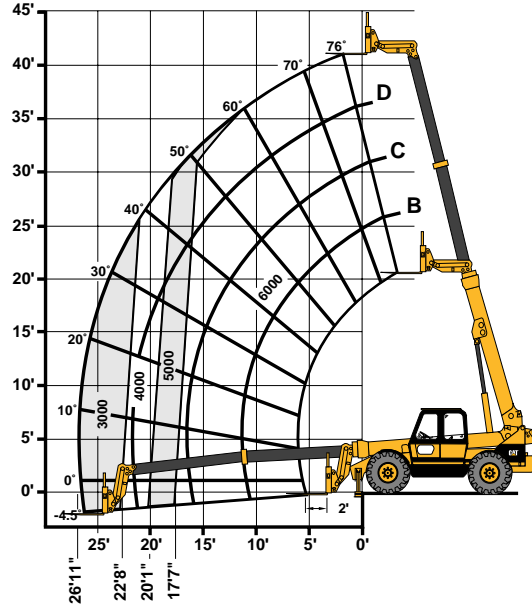

Numbers in chart measured in pounds.

Maximum lift capacity	2725 kg	6000 lb
Maximum lift height	12.5 m	41'0"
Load at maximum height	2725 kg	6000 lb
Maximum forward reach	8.2 m	27'0"
Load at maximum reach	1365 kg	3000 lb

Telescopic Handlers

Performance Data

- Standard Forks and Carriage
- No Stabilizers

TH82

Non-U.S. Version

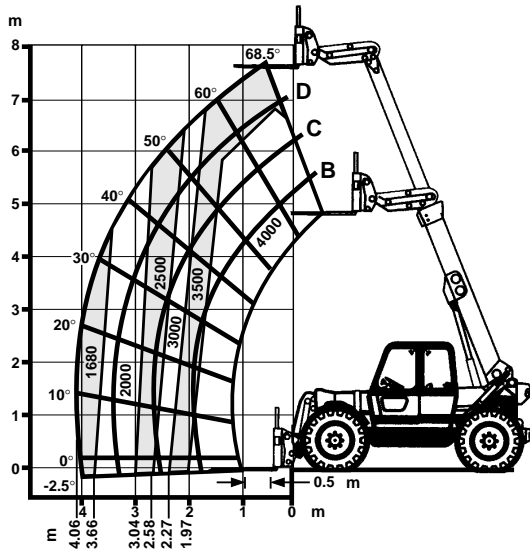

Numbers in chart measured in kilograms.

TH82

North American Version

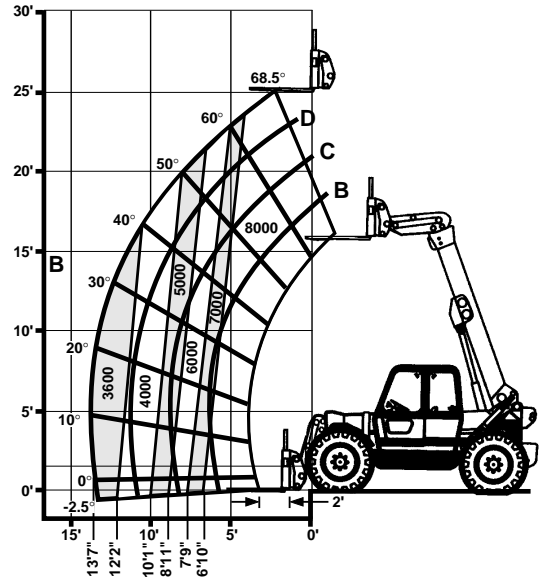

Numbers in chart measured in pounds.

Maximum lift capacity	4000 kg	8820 lb
Maximum lift height	7.6 m	25'0"
Load at maximum height	3500 kg	7717 lb
Max. height at maximum load	7.0 m	23'0"
Max. reach at maximum load	1.97 m	6'6"
Maximum forward reach	4.06 m	13'4"
Load at maximum reach	1680 kg	3704 lb

Maximum lift capacity	3635 kg	8000 lb
Maximum lift height	7.6 m	25'0"
Load at maximum height	3182 kg	7000 lb
Maximum forward reach	4.2 m	13'9"
Load at maximum reach	1635 kg	3600 lb

- Performance Data
- Standard Forks and Carriage
- Non-U.S. Version

Telescopic Handlers

TH83
Stabilizers Up

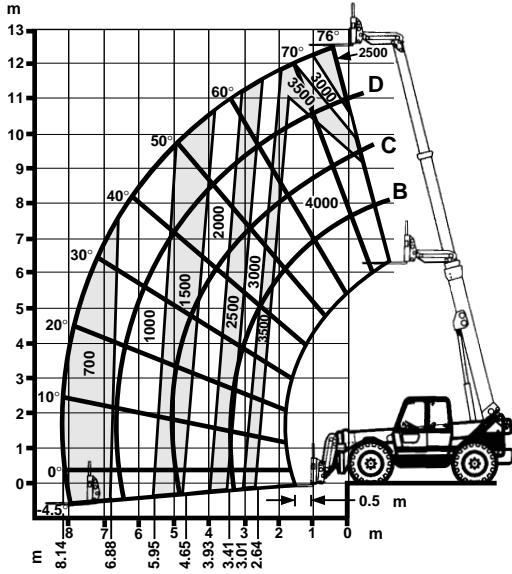

Numbers in chart measured in kilograms.

Maximum lift capacity	4000 kg	8820 lb
Maximum lift height	12.5 m	41'0"
Load at maximum height	2500 kg	5512 lb
Max. height at maximum load	11.0 m	36'1"
Max. reach at maximum load	2.64 m	8'8"
Maximum forward reach	8.14 m	26'8"
Load at maximum reach	700 kg	1543 lb

TH83
Stabilizers Down

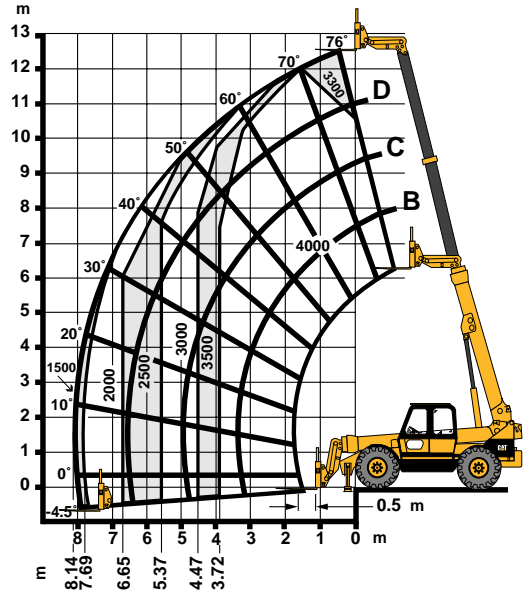

Numbers in chart measured in kilograms.

Maximum lift capacity	4000 kg	8820 lb
Maximum lift height	12.5 m	41'0"
Load at maximum height	3300 kg	7276 lb
Max. height at maximum load	12.25 m	40'2"
Max. reach at maximum load	3.72 m	12'2"
Maximum forward reach	8.14 m	26'8"
Load at maximum reach	1500 kg	3307 lb

Telescopic Handlers

Performance Data

- Standard Forks and Carriage
- North American Version

TH83
No Stabilizers

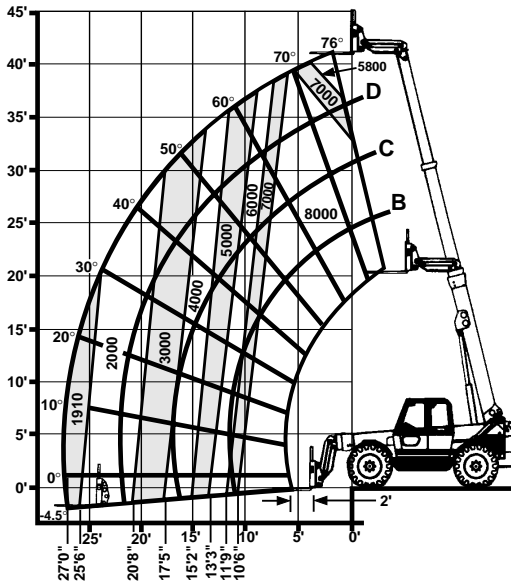

Numbers in chart measured in pounds.

Maximum lift capacity	3635 kg	8000 lb
Maximum lift height	12.5 m	41'0"
Load at maximum height	2725 kg	6000 lb
Maximum forward reach	8.2 m	27'0"
Load at maximum reach	870 kg	1910 lb

TH83
Stabilizers Down

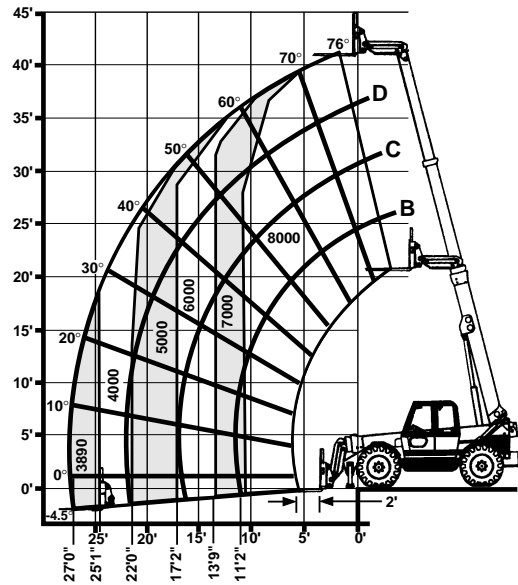

Numbers in chart measured in pounds.

Maximum lift capacity	3635 kg	8000 lb
Maximum lift height	12.5 m	41'0"
Load at maximum height	3635 kg	8000 lb
Maximum forward reach	8.2 m	27'0"
Load at maximum reach	1770 kg	3890 lb

- Performance Data
- Standard Forks and Carriage
- Non-U.S. Version

Telescopic Handlers

TH103
Stabilizers Up

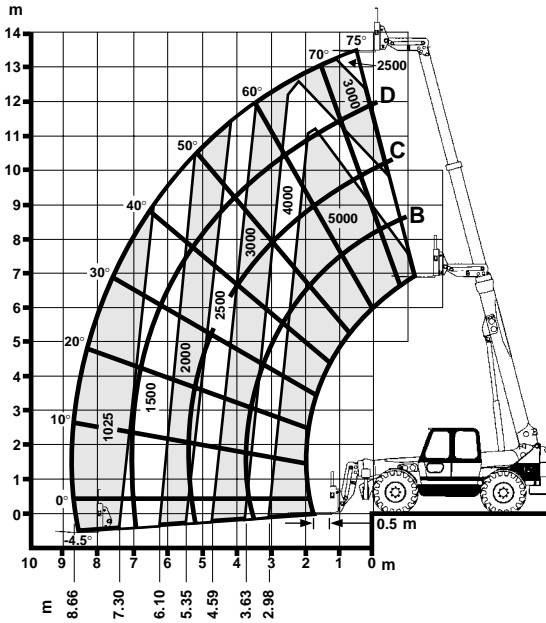

Numbers in chart measured in kilograms.

Maximum lift capacity	5000 kg	11,025 lb
Maximum lift height	13.5 m	44'0"
Load at maximum height	2500 kg	5513 lb
Maximum forward reach	8.66 m	28'4"
Load at maximum reach	1025 kg	2260 lb

TH103
Stabilizers Down

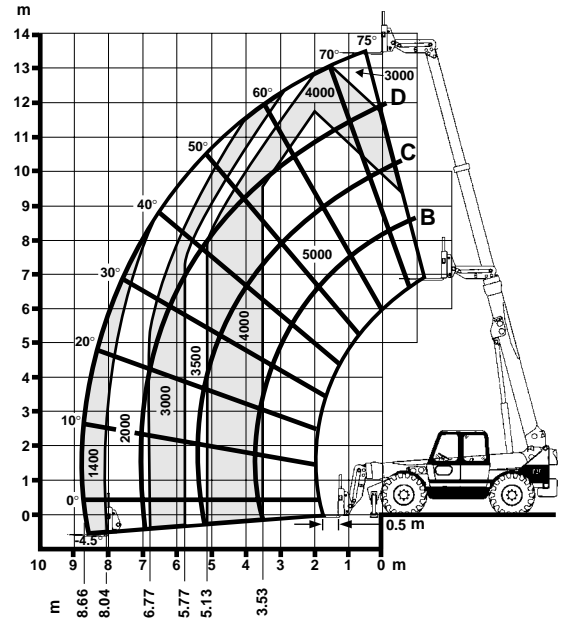

Numbers in chart measured in kilograms.

Maximum lift capacity	5000 kg	11,025 lb
Maximum lift height	13.5 m	44'0"
Load at maximum height	3000 kg	6615 lb
Maximum forward reach	8.66 m	28'4"
Load at maximum reach	1400 kg	3087 lb

Telescopic Handlers

Performance Data

- Standard Forks and Carriage
- North American Version

TH103

No Stabilizers

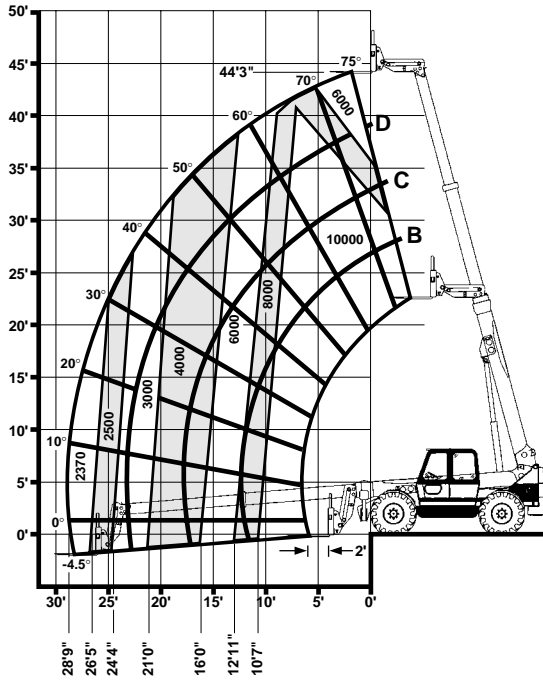

Numbers in chart measured in pounds.

TH103

Stabilizers Down

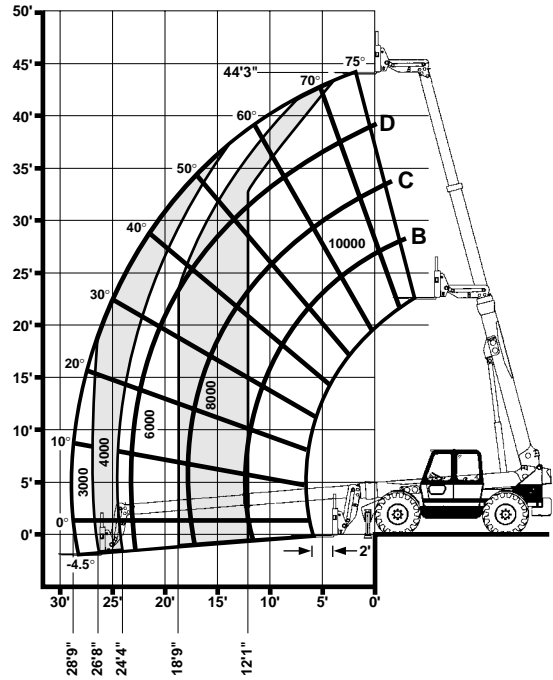

Numbers in chart measured in pounds.

Maximum lift capacity	4536 kg	10,000 lb
Maximum lift height	13.5 m	44'0"
Load at maximum height	2725 kg	6000 lb
Maximum forward reach	8.8 m	28'9"
Load at maximum reach	1075 kg	2370 lb

Maximum lift capacity	4536 kg	10,000 lb
Maximum lift height	13.5 m	44'0"
Load at maximum height	4536 kg	10,000 lb
Maximum forward reach	8.8 m	28'9"
Load at maximum reach	1365 kg	3000 lb

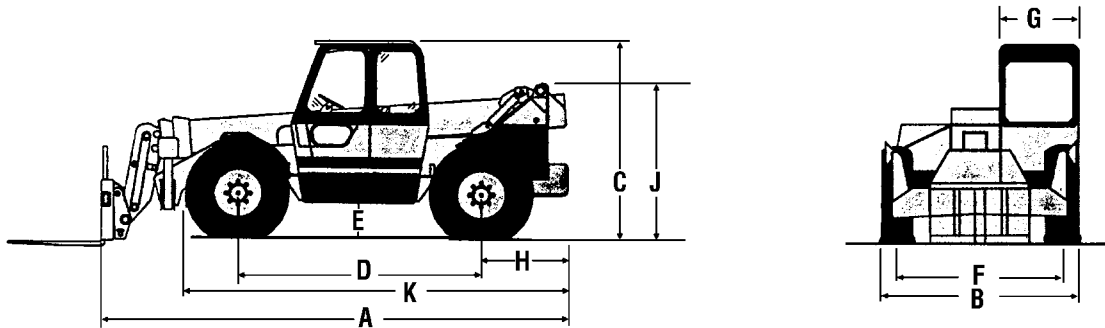

Dimensions (approx.)

MODEL	TH62		TH63		TH82		TH83		TH103	
	mm	ft	mm	ft	mm	ft	mm	ft	mm	ft
A) Length to fork face	4760	15'7"	5720	18'9"	4760	15'7"	5720	18'9"	6332	20'9"
B) Width	2230	7'4"	2450	8'0"	2450	8'0"	2450	8'0"	2440	8'0"
C) Height	2430	8'0"	2450	8'0"	2450	8'0"	2450	8'0"	2675	8'9"
D) Wheel base	2900	9'6"	2970	9'9"	2970	9'9"	2970	9'9"	3175	10'5"
E) Ground clearance	450	18"	450	18"	450	18"	450	18"	496	1'7.5"
F) Wheel track	1850	6'1"	2080	6'10"	2080	6'10"	2080	6'10"	2074	6'10"
G) Cab width (inside)	900	2'11"	955	3'2"	955	3'2"	955	3'2"	955	3'2"
H)	777	2'7"	1085	3'7"	772	2'6"	1060	3'6"	1318	4'4"
J)	1770	5'10"	1932	6'4"	1770	5'10"	1990	6'6"	2058	6'9"
K)	4316	14'2"	4688	15'5"	4374	14'4"	4662	15'4"	*	*

*Unavailable at time of printing.

Tire Selection

Non-U.S. Models			North American Models		
Model	Tire Size	Tire Type	Model	Tire Size	Tire Type
TH62	15.5 x 24 10PR*	Agricultural	TH62	13.0 x 24 12PR*	Construction
	17.5LR24	Agricultural		15.0 x 25 12PR	Construction
	13.0 x 24 12PR	Construction		17.5LR24	Agricultural
	15.5 x 25 12PR	Construction			
TH63	15.5 x 25 12PR*	Construction	TH63	13.0 x 24 12PR*	Construction ^(a)
	15.5 x 80-24	Agricultural		13.0 x 24 12PR	Construction ^(b)
				15.5 x 25 12PR	Construction ^(a)
TH82	15.5 x 25 12PR*	Construction	TH82	15.5 x 25 12PR	Construction ^(b)
	13.0 x 24	Construction		13.0 x 24 12PR*	Construction
	15.5 x 80-24	Agricultural		15.5 x 25 12PR	Construction
	17.5LR24	Agricultural		17.5LR24	Agricultural
	49.5/70R24	Agricultural			
TH83	14.0 x 24 12PR*	Construction	TH83	14.0 x 24 12PR*	Construction ^(a)
	17.5 x 25 12PR	Construction		14.0 x 24 12PR*	Construction ^(b)
				17.5 x 25 12PR	Construction ^(a)
TH103	14.0 x 24 16PR*	Construction	TH103	17.5 x 25 12 PR	Construction ^(b)
	17.5R25	Construction		14.0 x 24 16PR*	Construction
				17.5R25	Construction

*Standard tire.
^(a)No stabilizers.
^(b)With stabilizers.

- Carriages
- Forks

All carriages are bar type with load backrest to support bulky loads. Widespread carriages provide added stability for lifting larger loads. Standard and widespread carriages are also available in rotating mode.

Carriage Type

Model	Standard		Wide		Rotate		Wide/Rotate	
TH62 & TH63								
Capacity	3000 kg	6615 lb	2920 kg	6440 lb	2865 kg	6320 lb	2785 kg	6140 lb
Weight w/1220 mm (4'0") fork	240 kg	529 lb	320 kg	706 lb	375 kg	827 lb	455 kg	1003 lb
Width	1220 mm	4'0"	1880 mm	6'2"	1220 mm	4'0"	1880 mm	6'2"
Height	1155 mm	3'9"	1155 mm	3'9"	1155 mm	3'9"	1155 mm	3'9"
Max. fork spread	1200 mm	3'11"	1850 mm	6'1"	1200 mm	3'11"	1850 mm	6'1"
Floating fork movement	70 mm	3"	70 mm	3"	70 mm	3"	70 mm	3"
Rotation	—		—		12°		12°	
TH82/TH83								
Capacity	4000 kg	8820 lb	3920 kg	8640 lb	3890 kg	8580 lb	3810 kg	8400 lb
Weight w/1220 mm (4'0") fork	286 kg	631 lb	366 kg	807 lb	395 kg	871 lb	475 kg	1047 lb
Width	1220 mm	4'0"	1880 mm	6'2"	1220 mm	4'0"	1880 mm	6'2"
Height	1155 mm	3'9"	1155 mm	3'9"	1155 mm	3'9"	1155 mm	3'9"
Max. fork spread	1200 mm	3'11"	1850 mm	6'1"	1200 mm	3'11"	1850 mm	6'1"
Floating fork movement	70 mm	3"	70 mm	3"	70 mm	3"	70 mm	3"
Rotation	—		—		12°		12°	
TH103								
Capacity	5000 kg	11,025 lb	4920 kg	10,850 lb	4850 kg	10,690 lb	4680 kg	10,320 lb
Weight w/1220 mm (4'0") fork	318 kg	701 lb	398 kg	878 lb	468 kg	1032 lb	548 kg	1208 lb
Width	1220 mm	4'0"	1880 mm	6'2"	1220 mm	4'0"	1880 mm	6'2"
Height	1155 mm	3'9"	1155 mm	3'9"	1155 mm	3'9"	1155 mm	3'9"
Max. fork spread	1200 mm	3'11"	1850 mm	6'1"	1200 mm	3'11"	1850 mm	6'1"
Floating fork movement	70 mm	3"	70 mm	3"	70 mm	3"	70 mm	3"
Rotation	—		—		12°		12°	

Fork Type			Pallet			Block		
Model	Forks/Set	Size	Model	Forks/Set	Size	Model	Forks/Set	Size
TH62/TH63	2	50 x 100 x 1097 mm	TH62/TH63	4	50 x 50 x 1220 mm	TH62/TH63	4	50 x 50 x 1220 mm
	2	50 x 100 x 1220 mm		6	50 x 50 x 1220 mm		6	50 x 50 x 1220 mm
TH82/TH83	2	50 x 100 x 1220 mm	TH82/TH83/ TH103	4	50 x 50 x 1220 mm	TH82/TH83/ TH103	4	50 x 50 x 1220 mm
TH103	2	50 x 125 x 1220 mm		6	50 x 50 x 1220 mm		6	50 x 50 x 1220 mm

HEAVY DUTY BUCKET • Cutting Edge Included

Model	TH62		TH63/TH82/TH83/TH103	
Capacity (heaped)*	1.0 m ³	1.3 yd ³	1.07 m ³	1.4 yd ³
Width	2190 mm	7'2"	2438 mm	8'0"
Weight	444 kg	979 lb	446 kg	983 lb

LOOSE MATERIAL BUCKET • Cutting Edge Included

Model	TH62		TH63/TH82/TH83/TH103	
Capacity (heaped)*	1.5 m ³	2.0 yd ³	1.61 m ³	2.1 yd ³
Width	2290 mm	7'6"	2438 mm	8'0"
Weight	550 kg	1212 lb	590 kg	1300 lb

4 IN 1 BUCKET • Hydraulic Gripping Jaw Included

Model	TH62		TH63/TH82/TH83/TH103	
Capacity (heaped)*	0.75 m ³	1.0 yd ³	0.78 m ³	1.02 yd ³
Width	2290 mm	7'6"	2440 mm	8'0"
Weight	440 kg	970 lb	480 kg	1058 lb

ROOT CROP BUCKET

Model	TH62 & TH82			
Capacity (heaped)*	1.5 m ³		2.0 yd ³	
Width	2290 mm		7'6"	
Weight	410 kg		904 lb	

EXTENSION BOOM

Model	TH62/TH63/TH82/TH83/TH103		
Length	3660 mm		12'0"
Weight	310 kg		683 lb
Capacity	650 kg		1433 lb

MANURE FORK

Model	TH62 & TH82		Model	TH62 & TH82	
Capacity (heaped)*	1.9 m ³	2.5 yd ³	Capacity (heaped)*	1.9 m ³	2.5 yd ³
Width	2290 mm	7'6"	Width	2290 mm	7'6"
No. of tines	9		No. of tines	9	
Tine length	1060 mm	3'6"	Tine length	1060 mm	3'6"
Weight	375 kg	827 lb	Weight	595 kg	1312 lb

MANURE GRAB • Hydraulic Top Grab Included**MANURE FORK WITH PUSHOFF** • Includes Hydraulic Top Grab and Push Off

Model	TH62 & TH82			
Capacity (heaped)*	1.73 m ³		2.26 yd ³	
Width	2290 mm		7'6"	
No. of tines	9			
Tine length	1060 mm		3'6"	
Weight	575 kg		1268 lb	

*SAE Ratings.

GRAIN PUSHER

BALE SPIKE

Model	TH62 & TH82		Model	TH62 & TH82	
Blade width	2110 mm	6'11"	Width	1820 mm	6'0"
Forward reach	2110 mm	6'11"	No. of Tines	6	
Weight	320 kg	706 lb	Tine length	1370 mm	4'6"
			Weight	130 kg	287 lb

AVAILABLE ATTACHMENTS	TH62	TH63	TH82	TH83	TH103
Standard Carriage	●	●	●	●	●
Rotate Carriage*	●	●	●	●	●
Carriage, Wide/Framers	●	●	●	●	●
Carriage, Wide/Framers, Rotate*	●	●	●	●	●
Forks, Pallet — 2 of (50 x 100 x 1097 mm)	●	●	N/A	N/A	N/A
Forks, Pallet — 2 of (50 x 100 x 1220 mm)	●	●	●	●	N/A
Forks, Pallet — 2 of (50 x 125 x 1220 mm)	N/A	N/A	N/A	N/A	●
Forks, Block — 4 of (50 x 50 x 1220 mm)	●	●	●	●	●
Forks, Block — 6 of (50 x 50 x 1220 mm)	●	●	●	●	●
1.0 m ³ , Heavy Duty Bucket	●	N/A	N/A	N/A	N/A
1.07 m ³ , Heavy Duty Bucket	N/A	●	●	●	●
1.5 m ³ , Root Crop Ag Bucket	●	N/A	●	N/A	N/A
1.5 m ³ , Loose Material Bucket	●	N/A	N/A	N/A	N/A
1.61 m ³ , Loose Material Bucket	N/A	●	●	●	●
4 In 1, 0.75 m ³ , Bucket*	●	N/A	N/A	N/A	N/A
4 In 1, 0.78 m ³ , Bucket*	N/A	●	●	●	●
Manure Fork	●	N/A	●	N/A	N/A
Manure Grab*	●	N/A	●	N/A	N/A
Manure Fork and Push Off*	●	N/A	●	N/A	N/A
Extension Boom (3.66 m)	●	●	●	●	●
Blade, Grain Pusher	●	N/A	●	N/A	N/A
Bale Spike — 2 Bales	●	N/A	●	N/A	N/A
Quick Coupler, Hydraulic*	●	●	●	●	●
Hitch, Hydraulic Rear Tow	●	N/A	N/A	N/A	N/A

*Additional Hydraulics Required.

PAVING PRODUCTS

CONTENTS

COLD PLANERS

Features	16-1
Specifications	16-2
Production estimating	16-3
Machine selection	16-4
Cold planing fundamentals	16-4
Applications	16-5
Cold Planer use by project type	16-6

RECLAIMER MIXERS/STABILIZER MIXERS

Features	16-7
Specifications	16-8
Optional equipment	16-8
Production estimating	16-9
Weight of materials	16-10
Stabilization/Reclamation production	16-10

ASPHALT PAVERS

Features & Specifications	16-11
Barber-Greene	16-14
Production table	16-19

ROAD WIDENERS

Barber-Greene	16-20
---------------	-------

WINDROW ELEVATORS

Barber-Greene	16-21
---------------	-------

SMOOTH DRUM VIBRATORY SOIL COMPACTORS

Features & Specifications	16-22
Production table	16-25

PADDED DRUM VIBRATORY SOIL COMPACTORS

Features & Specifications	16-26
Production table	16-28

DUAL DRUM VIBRATORY ASPHALT COMPACTORS

Features & Specifications	16-29
Production rates	16-33

COMBINATION VIBRATORY ASPHALT COMPACTORS

Features & Specifications	16-34
---------------------------	-------

PNEUMATIC TIRE ASPHALT COMPACTORS

Features & Specifications	16-35 & 16-38
Production rates	16-37
Utilization	16-40

Cold Planer Features:

- **Cat Diesel Engines** with large piston displacement and individual adjustment-free fuel pumps and valves.
- **Up-cutting mandrels** provide cutting efficiency and improved bit life.
- **Grade and slope system** produces ± 3 mm (0.125 in) tolerance.
- **Non-contact sensors** speed set-up on PM-565B and PM-465.
- **Short turning radii** for productivity and jobsite flexibility.
- **Front-discharge conveyor on PM-565B and PM-465** facilitates haul unit movement in congested urban applications.
- **Optimum weight-to-horsepower balance** for delivering maximum available horsepower to the cutter.
- **Computerized Monitoring System (CMS)** provides three warning levels for abnormal operating conditions on PM-565B and PM-465.
- **Load control system** on PM-565B keeps machine operating at peak efficiency.
- **Variable width cutter** available for PM-565B.
- **Water spray system** for dust control and bit cooling.



MODEL	PM-465		PM-565B	
Flywheel Power	343 kW	460 hp	466 kW	625 hp
Operating Weight	25 880 kg	57,060 lb	38 000 kg	83,600 lb
Engine Model	3406C		3408E	
Rated Engine RPM	2100		2100	
No. of Cylinders	6		8	
Bore	137 mm	5.4"	137 mm	5.4"
Stroke	165 mm	6.5"	152 mm	6"
Displacement	14.6 L	893 in ³	18 L	1099 in ³
Drive Systems: Rotor	Mechanical		Mechanical	
Ground	Hydrostatic with 4 track design		Hydrostatic with 4 track design	
Discharge Conveyor Width	762 mm	2'6"	762 mm	2'6"
Width of Standard Track Shoe	250 mm	10"	348 mm	13.7"
Track Length on Ground	1242 mm	4'1"	2045 mm	6'8.5"
Ground Contact Area (w/std. shoe)	0.29 m ²	450 in ²	0.43 m ²	672 in ²
Operating Dimensions:				
Height	4.6 m	15'0"	4835 mm	14'11"
Width	2.5 m	8'2"	3151 mm	10'7"
Length	12.83 m	42'1"	14.5 m	47'6"
Standard Mandrel (Width of Cut)	1905 mm	6'3"	2100 mm	6'11"
No. of Teeth	137		—	
Depth of Cut (max.)	305 mm	12"	305 mm	12"
Optional Mandrel Widths	2000 mm	6'7"	N/A	
Speeds: Operating (max.)	0-37 m/min	0-120 ft/min	0-40 mpm	0-132 fpm
Speeds: Travel (max.)	0-5.2 km/hr	0-3.2 mph	0-6 km/hr	0-3.7 mph
Inside Turning Radius: Right	3.62 m	11'10"	4674 mm	15'4"
Left	4.12 m	13'6"	—	—
Grade Control	Contacting and Non Contacting Electric Over Hydraulic		Standard Non Contact Electric Over Hydraulic	
Slope Control	Electric Over Hydraulic		—	
Fuel Capacity	796 L	210 U.S. gal	946 L	250 U.S. gal
Water Capacity	2275 L	600 U.S. gal	3790 L	1000 U.S. gal

Speed		Cutter/Drum Width — m ² /min (yd ² /min)															
		1220 mm 4'0"		1900 mm 6'3"		2010 mm 6'7"		2100 mm 6'11"		2210 mm 7'3"		3050 mm 10'0"		3500 mm 11'6"		3810 mm 12'6"	
		m ²	yd ²	m ²	yd ²	m ²	yd ²	m ²	yd ²	m ²	yd ²	m ²	yd ²	m ²	yd ²	m ²	yd ²
3.0	10	3.7	4.4	5.8	6.9	6.1	7.3	6.4	7.7	6.7	8.0	9.3	11.1	10.7	12.8	11.6	13.9
4.6	15	5.6	6.6	8.7	10.4	9.3	11.0	9.7	11.5	10.0	12.1	13.9	16.7	16.1	19.2	17.4	20.8
6.1	20	7.5	8.8	11.6	13.9	12.3	14.6	12.8	15.4	13.4	16.1	18.6	22.2	21.4	25.5	23.3	27.8
7.6	25	9.3	11.1	14.5	17.4	15.4	18.3	16.1	19.2	16.7	20.1	23.2	27.8	26.8	31.9	29.1	34.7
9.1	30	11.1	13.3	17.4	20.8	18.4	22.0	19.2	23.1	20.1	24.2	27.9	33.3	32.1	38.3	34.9	41.7
10.7	35	13.1	15.5	20.3	24.3	21.6	25.6	22.6	26.9	23.4	28.2	32.5	38.9	37.5	44.7	40.7	48.6
12.2	40	15.0	17.8	23.2	27.8	24.6	29.3	25.7	30.7	26.8	32.2	37.1	44.4	42.8	51.1	46.5	55.5
13.7	45	16.8	20.0	26.1	31.2	27.7	33.0	28.9	34.6	30.1	36.2	41.8	50.0	48.2	57.5	52.3	62.5
15.2	50	18.7	22.2	29.0	34.7	30.7	36.6	32.1	38.4	33.5	40.3	46.4	55.5	53.5	63.9	58.1	69.4
16.8	55	20.6	24.4	31.9	38.2	33.9	40.2	35.4	42.3	36.8	44.3	51.1	61.1	58.9	70.3	63.9	76.4
18.3	60	22.5	26.7	34.9	41.7	37.0	43.9	38.7	46.1	40.1	48.3	55.7	66.7	64.2	76.7	69.8	83.3

Speed		Cutter/Drum Width — metric tons/min (U.S. tons/min)															
		1220 mm 4'0"		1900 mm 6'3"		2010 mm 6'7"		2100 mm 6'11"		2210 mm 7'3"		3050 mm 10'0"		3500 mm 11'6"		3810 mm 12'6"	
		Metric tons	U.S. tons	Metric tons	U.S. tons	Metric tons	U.S. tons	Metric tons	U.S. tons	Metric tons	U.S. tons	Metric tons	U.S. tons	Metric tons	U.S. tons	Metric tons	U.S. tons
3.0	10	0.23	0.26	0.36	0.40	0.38	0.42	0.41	0.44	0.44	0.46	0.58	0.64	0.67	0.74	0.73	0.80
4.6	15	0.35	0.38	0.54	0.60	0.57	0.63	0.61	0.66	0.66	0.69	0.87	0.96	1.00	1.10	1.09	1.20
6.1	20	0.46	0.51	0.72	0.80	0.76	0.84	0.82	0.88	0.88	0.92	1.16	1.28	1.34	1.47	1.46	1.79
7.6	25	0.58	0.64	0.91	1.00	0.94	1.04	1.02	1.10	1.10	1.15	1.45	1.60	1.67	1.83	1.82	1.99
9.1	30	0.69	0.77	1.09	1.20	1.14	1.26	1.23	1.33	1.32	1.39	1.74	1.91	2.01	2.20	2.19	2.40
10.7	35	0.81	0.89	1.27	1.40	1.34	1.47	1.44	1.55	1.54	1.62	2.03	2.24	2.34	2.57	2.56	2.79
12.2	40	0.92	1.02	1.45	1.60	1.53	1.68	1.65	1.76	1.76	1.85	2.32	2.55	2.68	2.94	2.92	3.19
13.7	45	1.04	1.15	1.63	1.80	1.71	1.88	1.84	1.99	1.98	2.08	2.61	2.87	3.01	3.31	3.28	3.59
15.2	50	1.16	1.28	1.81	2.00	1.91	2.10	2.05	2.21	2.20	2.32	2.90	3.19	3.35	3.67	3.65	3.99
16.8	55	1.27	1.41	1.99	2.20	2.09	2.31	2.25	2.43	2.42	2.55	3.19	3.51	3.68	4.04	4.01	4.39
18.3	60	1.39	1.53	2.18	2.40	2.28	2.51	2.46	2.65	2.64	2.78	3.48	3.83	4.02	4.41	4.38	4.79

NOTE: Above figures are based on a one-inch depth of cut. For greater depths of cut, multiply the production rate by cutting depth. Based on asphalt density of 115 lb/yd³, one inch thick.

MACHINE SELECTION

Prime considerations in selecting the proper cold planer model are:

- specifics of work to be done
- type of projects generally done by the contractor
 - City/Urban or Highway/Airport
- desired production capacities

Cold Planer Characteristics (Highway/Airport)

Highway/Airport work requires high-volume cold planers. The PM-565B and other high horsepower half-lane cold planers are being used more on Highway/Airport projects. Users like to have one machine that can work successfully on high production jobs then switch to city/urban applications. The PM-565B has proven to be a true cross-over cold planer.

Cold Planer Characteristics (City/Urban)

The PM-465 is a four track, front discharge cold planer designed primarily for the Urban/City environment. The PM-465, with its tight turning radius and easy set up, makes it suitable for many applications. The PM-465 has the productive capacity to perform effectively on highway applications as well. Machine dimensions and weight allow transport on one truck, often no special weight permits are required.

The PM-565B is a four-track, front discharge model. Front discharge cold planers make traffic control easier in congested quarters. The trucks travel forward in the same direction as the cold planer. The trucks move in and out of traffic faster increasing production.

COLD PLANING FUNDAMENTALS

Definition

Cold planing is automatically controlled cold milling to restore the pavement surface to a specified grade and slope; remove bumps, ruts, and other imperfections; and leave a textured surface which can be opened immediately to traffic or overlaid with new pavement materials.

Production and Tooth Wear

Because pavement materials vary, so do production and tooth wear. While predicting the exact production rate and tooth wear on a particular job is difficult, general guidelines are available.

Production depends on the milling rate (the speed at which the cold planer moves forward). The machine's forward speed is determined, primarily, by aggregate type, asphalt bond strength and depth of cut. When milling asphalt pavement, the cold planer's teeth essentially are breaking the bond between asphalt-coated aggregate, not actually fracturing the aggregate itself. A pavement made with a mix containing a high percentage of fine aggregate and a high asphalt content is more difficult to mill than a pavement with a high percentage of coarse aggregate.

A dense or fine mix usually requires more power at the cutting drum, limiting the cold planer's forward speed. Decreased speed lowers production, and the tough bond between the small aggregate particles causes increased cutting-tooth wear. Lower production and higher tooth wear result in increased unit costs.

Cutting depth affects power demand at the drum and helps determine the cold planer's forward speed. However, production increases, to a point, as the depth of cut increases. For example, changing from a 25 mm (1 in) cut to a 51 mm (2 in) cut slows the machine only slightly but doubles the amount of material produced.

As the cut increases beyond the machine's peak-production depth, the reduced forward speed begins to offset the production gains of the deeper cut. For example, production at a 152 mm (6 in) cutting depth and slow speed may be no greater than cutting at a 76 mm (3 in) depth and a much faster speed.

As long as the cold planer maintains a productive forward speed, deeper cuts will yield greater production and tend to lower tooth cost. Tooth wear does not increase in direct proportion to production when the machine is working in an efficient range.

Tooth wear at various depths for a given material is affected by how long the tooth remains in the cut. Because the teeth are mounted on a circular drum, each tooth cuts through the pavement in an arc. The tooth arc at a 102 mm (4 in) cutting depth, however, is not four times longer than at a 25 mm (1 in) cutting depth, even though production may be four times greater. The cutting arc at 102 mm (4 in) is approximately twice as long as that at 25 mm (1 in).

The peak cutting depth for a particular cold planer on a specific job is best determined by examining production, and subsequent costs, of a single deep cut versus multiple passes at a shallow depth.

APPLICATIONS

Although new applications for cold planers are being discovered, most work can be classified in seven general categories:

Leveling and Bonding

This application removes a layer of pavement to eliminate potholes, ruts, bumps and other surface imperfections. The cold planer leaves a level, textured surface ideal for bonding to a new, thin overlay of asphalt or concrete. The surface has an interlocking texture with double the bonding area of a conventional smooth pavement. The textured surface and overlay form a monolithic bond, eliminating the shear plane that causes pavement layers to move and separate. Thinner overlays can be used, making the technique more economical than traditional overlay methods.

Surface Refinishing

Rough pavement can also be cold planed to specified grade and slope, providing a new riding surface without adding new paving materials. This application is particularly useful when base and sub-base are in good shape, or when several layers have been added to the roadway over the years. Roads can be cold planed during cold, wet months and reopened immediately. New overlays can be added whenever weather permits. This lengthens the practical working season for many contractors. The cold planer can also be used to correct expansion joint faults and pavement cracks.

Surface Repair

This category generally requires deeper cutting than leveling. It consists of removing isolated distressed pavement sections down to subbase, if necessary, prior to adding new overlay materials. Since the cutter mandrel on Caterpillar cold planers cuts forward and upward, there's no damaging impact to the underlying base.

Pavement Removal

Pavement buildup is a problem that plagues most older streets, roads and highways. As overlays are added, curbs and drains are buried — creating drainage problems. Overhead clearances are dangerously reduced ... and additional weight is added to overpasses and bridges. Cold planing is an economical method of curing all these problems.

Surface Texturing

Serious accidents increase when pavement becomes slick from wear. The textured surface produced by cold planing is highly skid-resistant and has dramatically reduced hydroplaning characteristics.

Pavement Mining

Cold milling has made it practical to actually “mine” deteriorated pavement materials from existing roads and streets. The cold planer produces an ideally-sized asphalt or concrete material which can be recycled in a variety of ways. Depending on type, age and condition of pavement, the largest cold planer can reclaim up to 900 tons of material per hour.

COLD PLANER USE BY PROJECT TYPE

Applications	Highway/Airport	City/Urban
Planing (Milling)	<ul style="list-style-type: none"> • To establish grade and slope. • Remove excess pavement. 	<ul style="list-style-type: none"> • To establish proper grade and slope. • To establish new grade and slope.
Partial Removal	<ul style="list-style-type: none"> • For use with hot mix recycle. • Remove pavement irregularities. • Texture for skid resistance. 	<ul style="list-style-type: none"> • To correct drainage and curb reveal. • To lower elevation at overpass. • For use with hot recycle. • Eliminate leveling course.
Full Depth Removal	<ul style="list-style-type: none"> • Total rebuild. RAP used for base or hot recycle. • Cold recycle. This requires additional surface treatment. 	<ul style="list-style-type: none"> • Total rebuild. RAP used for base or hot recycle. • Cold recycle. Requires additional surface treatment.
Texturing	<ul style="list-style-type: none"> • For skid resistance and improved bond when overlay is applied. 	<ul style="list-style-type: none"> • For skid resistance and improved bond when overlay is applied.
Leveling		<ul style="list-style-type: none"> • At intersections to remove bumps, shoving and improve drainage.
Special	<ul style="list-style-type: none"> • Joint and crack repair. • Cut rumble grooves on shoulders of bridge approaches. 	<ul style="list-style-type: none"> • Intersection defect repair. • Pothole repair. • Railroad crossing repair. • Tight radius profiling around manhole covers, etc. • Pavement adjustments (transitions from existing pavements to new overlays).

RR-250B:

The RR-250B is a single rotor full depth reclaiming machine. It uses a cutting mandrel to pulverize and mix asphaltic pavement and base materials. The machine is utilized to mechanically stabilize deteriorated asphalt structures and complete reclamation with the addition of asphaltic emulsions or other binding agents. The RR-250B can be equipped with attachments that accurately inject liquid additives directly into the mixing hood. Optional rotors can be installed to convert the RR-250B into a soil stabilizer. The internally mounted breaker bar aids in material sizing.

SS-250B:

The SS-250B is a single rotor soil stabilization machine. The machine cuts, mixes and pulverizes native in-place soils or select materials, with or without additives. It modifies and stabilizes the soil obtaining a strong base.

Both the RR & SS-250B feature automatic depth control, engine load sensing, and rear steering.

RM-350B:

The RM-350B is a heavy-duty reclaimer/mixer, that can perform either full depth reclamation, or soil stabilization. Rotor options allow the RM-350B to perform the pulverization of asphalt pavement, or the mixing of stabilizing agents with soils to produce a strong base material.

The RM-350B features microprocessor control of major machine systems, including propel speed, rotor depth, and steering modes.

RR-250B/SS-250B Features:

- **Maximum Production** ... rotor driven by Cat turbocharged Diesel Engine through mechanical drive system.
- **Highly Efficient** ... load-sensing propel system helps prevent overloading while allowing continuous work near rated horsepower.
- **Extremely Versatile** ... interchangeable rotors provide both reclamation and stabilization capabilities.
- **Consistent Blending** ... automatic depth control, mid-mounted mixing chamber and multi-speed rotor drive combine for optimum blending and increased production.

RM-350B Features:

- **Maximum Production** ... mechanical rotor drive, with deep cutting and mixing capability, via Cat turbocharged Diesel Engine and Cat three-speed transmission.
- **Efficient Operation** ... Cat Electronic Control Module provides microprocessor control of major machine systems.
- **Highly Maneuverable** ... four steering modes with automatic rear wheel alignment simplify work in congested areas.
- **Versatility** ... choice of three rotors for full depth reclamation or soil stabilization.
- **Reliability** ... field proven Cat components maximize machine availability.



MODEL	RR-250B			SS-250B			RM-350B		
Flywheel Power	250 kW	335 hp		250 kW	335 hp		373 kW	500 hp	
Operating Weight	19 264 kg	42,470 lb		14 343 kg	31,620 lb		24 040 kg	53,000 lb	
Engine Model	3406C			3406C			3406D DITA		
Rated Engine RPM	2100			2100			2100		
No. Cylinders	6			6			6		
Bore	137 mm	5.4"		137 mm	5.4"		137 mm	5.4"	
Stroke	165 mm	6.5"		165 mm	6.5"		165 mm	6.5"	
Displacement	14.6 L	893 in³		14.6 L	893 in³		14.6 L	893 in³	
Drive Systems: Rotor	3 speed Mechanical			3 speed Mechanical			3 speed Mechanical		
Ground	4 speed Hydrostatic			4 speed Hydrostatic			4 speed Hydrostatic		
Operating Dimensions: Height	2600 mm	8'6.5"		2600 mm	8'6.5"		3404 mm	11'2"	
Width	2921 mm	9'7"		2921 mm	9'7"		2997 mm	9'10"	
Length	8560 mm	28'1"		8560 mm	28'1"		9595 mm	31'6"	
Width of Cut	2438 mm	8'0"		2438 mm	8'0"		2438 mm	8'0"	
Depth of Cut (Max.)	330 mm	13"		457 mm	18"		508 mm	20"	
Rotor Speed	Trans	Drive	Speed	Trans	Drive	Speed	Trans	Drive	Speed
	Low	Low	123 rpm	Low	Low	123 rpm	Low	Low	115 rpm
	Low	High	168 rpm	Low	High	168 rpm	Low	High	160 rpm
	High	Low	284 rpm	High	Low	284 rpm	High	Low	215 rpm
Minimum Turning Radius:									
Standard	5.5 m	18'0"		5.5 m	18'0"		5.48 m	18'0"	
Travel Speed (Max.)	19.3 km/h	12 mph		19.3 km/h	12 mph		16.8 km/h	10.5 mph	
Standard Tires: Front	23.5 × 25-16 ply Lug Type E-2			28.1 × 26-10 PR Lug			23.5R25, L-2 Loader/Dozer		
Rear	15.5 × 25-8 ply Lug Type L-2			14.9 × 24-6 PR Lug			19.5L × 24-12 R-4 Lug All		
Fuel Capacity	416 L	110 U.S. gal		416 L	110 U.S. gal		779 L	206 U.S. gal	
Cooling System	61 L	16 U.S. gal		61 L	16 U.S. gal		61 L	16 U.S. gal	
Crankcase	34 L	9 U.S. gal		34 L	9 U.S. gal		34 L	9 U.S. gal	

OPTIONAL EQUIPMENT — RR-250B/SS-250B

- Roll Over Protective Structure (ROPS).
- Foot per minute indicator (available in metric).
- Working light package.
- Cab with heater, defroster and air conditioner.
- Liquid additive system (emulsion or water) (English or Metric).
- Water spray system with in-line flow meter.
- Rear wheel power.
- Sound suppression package.
- Torque limiter.
- Mirror package.

OPTIONAL EQUIPMENT — RM-350B

- Roll Over Protective Structure (ROPS).
- Working light package.
- Roading light package.
- Deluxe cab.
- Liquid additive system (emulsion or water).
- Water spray system.
- Sound suppression package.
- Rear wheel power.
- Mirror package.

Rotor Options for SS-250B

Rotor	Maximum Depth of Work	No. of Bits/Tools	Direction of Cut
Quick Change Tool	381 mm 15"	58	Up
Deep Mix Quick Change	457 mm 18"	58	Down
Combination	381 mm 15"	108	Up

Rotor Options for RR-250B

Rotor	Maximum Depth of Work	No. of Bits/Tools	Direction of Cut
Cone Tool Milldrum	330 mm 13"	188	Up
Breakaway Holder Rotor	330 mm 13"	188	Up
Quick Change	381 mm 15"	58	Up
Combination	381 mm 15"	108	Up

Rotor Options for RM-350B

Rotor	Maximum Depth of Work	No. of Bits/Tools	Direction of Cut
Reclamation	381 mm 15"	190	Up
Quick Change	508 mm 20"	58	Up
Combination	457 mm 18"	108	Up

Other rotors available by custom order.

PRODUCTION ESTIMATING

The maximum cutting depth is 381 mm (15") for the RR-250B and 457 mm (18") for the RM-350B. The SS-250B can mix up to 457 mm (18"). In addition, the cutting width of their rotors is 8 feet. The following formulas allow you to determine the production in square yards (yd²)/minute or cubic yards (yd³)/ minute.

Production in square yards (yd²) per minute

$$\text{yd}^2/\text{min} = \frac{\text{FPM of travel speed}}{1.125}$$

$$\frac{9 \text{ ft}^2/\text{yd}^2}{8 \text{ ft Cutting width}} = 1.125 \text{ (This is a constant value for an eight foot wide rotor)}$$

Gallons of additive (for units with pump and metering additive system)

$$\frac{\text{GPM}}{\text{yd}^2/\text{min}} = \text{gal}/\text{yd}^2$$

Or, if required additive amounts are known, you can determine necessary travel speed as shown:

$$\frac{\text{GPM}}{\text{gal}/\text{yd}^2} = \text{yd}^2/\text{min}; \text{yd}^2/\text{min} \times 1.125 = \text{ft}/\text{min}$$

Production in Cubic Yards (yd³) per minute

$$\frac{\text{FPM of travel speed}}{1.125} \times \frac{\text{Cutting or mixing depth in inches}}{36} = \frac{\text{yd}^3}{\text{min}}$$

Production in Tons per Minute

$$\text{yd}^3/\text{min} \times \frac{\text{Wt. of Material per yd in lbs}}{2000 \text{ lb}/\text{ton}} = \text{tons}/\text{min}$$

Abbreviations

FPM = Feet Per Minute
GPM = Gallons Per Minute

WEIGHT OF MATERIALS

Material		LOOSE		IN-PLACE	
		kg/m ³	lbs/yd ³	kg/m ³	lbs/yd ³
Clay	— Dry	1480	2500	1840	3100
	— Wet	1660	2800	2080	3500
Clay and Gravel	— Dry	1420	2400	1660	2800
	— Wet	1540	2600	1840	3100
Sand and Gravel	— Dry	1720	2900	1930	3250
	— Wet	2020	3400	2220	3750
Sand	— Dry	1420	2400	1600	2700
	— Damp	1690	2850	1900	3200
	— Wet	1840	3100	2080	3500
Earth	— Dry Packed	1510	2550	1900	3200
	— Wet Excavated	1600	2700	2020	3400
	— Top Soil	950	1600	1360	2300
	— Loam	1250	2100	1540	2600
Bituminous Concrete	— Windrowed Chunks (25% Voids)	1740	2925		
	— Compacted			2310	3900

STABILIZATION/RECLAMATION PRODUCTION

The following charts list production in square meters per minute, square yards per minute, cubic meters per minute, and cubic yards per minute. The information is based on various travel speeds and cutting depths for the Caterpillar RM-350B, RR-250B and SS-250B equipped with a 2438 mm (8 ft) cutting rotor.

PRODUCTION RATES																		
Travel Speed m/min	m ² / min	m ³ /Minute																
		Cutting Depth — mm																
		100	125	150	175	200	225	250	275	300	325	350	375	400	425	450	475	500
3	7.3	0.73	0.9	1.1	1.3	1.5	1.6	1.8	2.0	2.2	2.4	2.6	2.7	2.9	3.1	3.3	3.5	3.7
6	14.6	1.46	1.8	2.2	2.6	2.9	3.3	3.7	4.0	4.4	4.8	5.1	5.5	5.9	6.2	6.6	6.9	7.3
9	21.9	2.2	2.7	3.3	3.8	4.4	4.9	5.5	6.0	6.6	7.1	7.7	8.2	8.8	9.3	9.9	10.4	11.0
12	29.3	2.9	3.7	4.4	5.1	5.9	6.6	7.3	8.0	8.8	9.5	10.2	11.0	11.7	12.4	13.2	13.9	14.6
15	36.6	3.6	4.6	5.5	6.4	7.3	8.2	9.1	10.0	11.0	11.9	12.8	13.7	14.6	15.5	16.5	17.4	18.3
18	43.9	4.4	5.5	6.6	7.7	8.8	9.9	11.0	12.1	13.2	14.3	15.4	16.5	17.6	18.7	19.7	20.8	21.9
21	51.2	5.1	6.4	7.7	9.0	10.2	11.5	12.8	14.1	15.4	16.6	17.9	19.2	20.5	21.8	23.0	24.3	25.6
24	58.5	5.9	7.3	8.8	10.2	11.7	13.2	14.6	16.1	17.6	19.0	20.5	21.9	23.4	24.9	26.3	27.8	29.3
27	65.8	6.6	8.2	9.9	11.5	13.2	14.8	16.4	18.1	19.7	21.4	23.0	24.7	26.3	28.0	29.6	31.3	32.9

PRODUCTION RATES																		
Travel Speed ft/min	yd ² / min	yd ³ /Minute																
		Cutting Depth — inches																
		4	5	6	7	8	9	10	11	12	13	14	15	16	17	18	19	20
10	8.9	0.98	1.2	1.5	1.7	2.0	2.2	2.5	2.7	3.0	3.2	3.5	3.7	4.0	4.2	4.5	4.7	4.9
20	17.8	1.96	2.5	3.0	3.4	4.0	4.4	4.9	5.5	5.9	6.4	6.9	7.4	7.9	8.4	8.9	9.4	9.9
30	26.7	2.9	3.7	4.5	5.2	5.9	6.7	7.4	8.2	8.9	9.6	10.4	11.1	11.9	12.6	13.4	14.0	14.8
40	35.6	3.9	4.9	5.9	6.9	7.9	8.9	9.9	10.9	11.9	12.8	13.9	14.8	15.8	16.8	17.8	18.7	19.8
50	44.5	4.9	6.2	7.4	8.6	9.9	11.1	12.4	13.6	14.8	16.0	17.3	18.5	19.8	21.0	22.3	23.4	24.7
60	53.4	5.9	7.4	8.9	10.3	11.9	13.3	14.8	16.4	17.8	19.2	20.8	22.2	23.7	25.2	26.7	28.1	29.7
70	62.3	6.8	8.6	10.4	12.0	13.8	15.6	17.3	19.1	20.8	22.4	24.3	25.9	27.7	29.5	31.2	32.8	34.6
80	71.2	7.8	9.9	11.9	13.7	15.8	17.8	19.8	21.8	23.7	25.6	27.7	29.6	31.6	33.7	35.6	37.5	39.6
90	80.1	8.8	11.1	13.4	15.5	17.8	20.0	22.4	24.5	26.7	28.8	31.2	33.3	35.6	37.9	40.1	42.1	44.5



Features:

- **Variable width Extend-A-Mat B screeds or Pavemaster B fixed screeds** available for AP-650B, AP-800C, AP-1000B, AP-1050B and AP-1055B.
- **Single sliding operator’s station** on AP-650B thru AP-1055B can be positioned on either side of paver for excellent visibility.
- **Hydrostatic pumps** provide infinitely variable speed ranges.
- **Direct hydrostatic drives** on the AP-650B thru AP-1055B eliminate gear boxes, differentials, final drive chains etc.
- **Patented variable speed hydraulic augers on AP-200B** extend with wings to ensure proper material distribution.
- **Self-dumping hydraulic hoppers** are heavy-duty and high capacity.
- **Self-cleaning all-steel tracks on AP-200B** assure long life with virtually no maintenance required.

MODEL

AP-200B

Flywheel Power	26 kW	35 hp
Rated Engine RPM	2650	
No. Cylinders	2	
Displacement	1.716 L	104.7 in³
Engine Model	Hatz 2m40 Air-Cooled Diesel	
Operating Weight (empty)	4080 kg	9000 lb
Speeds	0-54 m/min	0-176 ft/min
Maximum theoretical capacity	609.6 (t)/hr	600 TPH
Track Assemblies:		
Width	381 mm	15"
Length on Ground	760 mm	2'6"
Outside to Outside	2440 mm	8'0"
General Dimensions:		
Basic Width	3000 mm	9'10"
Length	2440 mm	8'0"
Height (less exhaust stack)	1730 mm	6'8"
Wheelbase	—	
Hopper Capacity	5.4 metric ton	6 standard tons
Screed (extendable)	2743 to 3658 mm	9'0" to 12'0"
Paving Width:		
Minimum	914 mm	3'0"
Maximum	3658 mm	12'0"
Service Refill Capacities:		
Cooling system	Air-cooled	
Fuel tank	39.8 L	10.5 U.S. gal
Hydraulic oil tank	75.8 L	20 U.S. gal



MODEL	AP-800C		AP-1000B	
Flywheel Power	80 kW	107 hp	130 kW	174 hp
Rated Engine RPM	2200		2200	
No. Cylinders	4		6	
Displacement	4 L	243 in ³	6.6 L	403 in ³
Engine Model	3054DIT		3116TA	
Operating Weight:				
Tractor	12 202 kg	26,900 lb	16 190 kg	35,700 lb
Pavemaster B Screed	8 ft	1374 kg	—	—
10 ft	1656 kg	3650 lb	1656 kg	3650 lb
Extend-A-Mat B Screed	8 ft	2994 kg	—	—
10 ft	3266 kg	7200 lb	3266 kg	7200 lb
Extend-A-Mat B Wide Plates	10 ft	—	3760 kg	8300 lb
Speeds: Paving	0-76 m/min	0-250 ft/min	0-114 m/min	0-374 ft/min
Travel	0-19 km/h	0-12 mph	0-23.5 km/h	0-14.5 mph
Maximum theoretical capacity	1801 (t)/hr	1773 TPH	2177 (t)/hr	2400 TPH
Tires:				
Front (4)	13 × 22 Solid Rubber		16 × 22 Solid Rubber	
Rear (2)	16.00 × 24		18.00 × 25 16 PR sand rib	
Dimensions:				
Operating Width	8 ft Screed	3269 mm	10'9"	—
10 ft Screed	3327 mm	10'11"	3327 mm	10'11"
Shipping Width*	8 ft Screed	2438 mm	8'0"	—
10 ft Screed	3048 mm	10'0"	3048 mm	10'0"
Height (less exhaust)	2620 mm	8'7"	2769 mm	9'1"
Length (Extend-A-Mat B, push roller)	6477 mm	21'3"	6783 mm	22'3"
Turning Radius	2896 mm	9'6"	2900 mm	9'6"
Wheelbase	2336 mm	7'8"	2540 mm	8'4"
Hopper Capacity	5.5 m ³	195 ft ³	6.1 m ³	215 ft ³
Auger Diameter	406 mm	16"	406 mm	16"
Paving Widths:				
Pavemaster B Screed				
(Min. w/cutoff shoes)	8 ft	1828 mm	6'0"	—
(Max. w/extensions)	6096 mm	20'0"	—	—
Pavemaster B Screed				
(Min. w/cutoff shoes)	10 ft	2438 mm	8'0"	2438 mm
(Max. w/extensions)	6096 mm	20'0"	9147 mm	30'0"
Extend-A-Mat B Screed				
(Min. w/cutoff shoes)	8 ft	1828 mm	6'0"	—
(Max. w/extensions)	4724 mm	15'6"	—	—
Extend-A-Mat B Screed				
(Min. w/cutoff shoes)	10 ft	2438 mm	8'0"	2438 mm
(Max. w/extensions)	6147 mm	20'2"	7290 mm	24'2"
Service Refill Capacities:				
Cooling system	19 L	5 U.S. gal	37 L	9.78 U.S. gal
Fuel tank	189 L	50 U.S. gal	265 L	70 U.S. gal
Hydraulic oil tank	189 L	50 U.S. gal	189 L	50 U.S. gal

*Transport width — hoppers raised without end gates.



MODEL	AP-650B		AP-1050B		AP-1055B	
Flywheel Power	70 kW	121 hp	130 kW	174 hp	180 kW	174 hp
Rated Engine RPM	2200		2200		2200	
No. Cylinders	4		6		6	
Displacement	4 L	243 in ³	6.6 L	403 in ³	6.6 L	403 in ³
Engine Model	3054TA		3116T		3116TA	
Operating Weight:						
Tractor	11 790 kg	25,990 lb	15 785 kg	34,800 lb	16 103 kg	35,500 lb
Pavemaster B Screed	8 ft	1374 kg	—	—	—	—
	10 ft	—	1656 kg	3650 lb	1656 kg	3650 lb
Extend-A-Mat B Screed	8 ft	2944 kg	—	—	—	—
	10 ft	—	3266 kg	7200 lb	3266 kg	7200 lb
Extend-A-Mat B Wide plates	10 ft	—	3760 kg	8300 lb	3760 kg	8300 lb
Speeds: Paving: 1st	0-67 m/min	0-220 ft/min	0-65.6 m/min	0-215 ft/min	0-61 m/min	0-200 ft/min
Travel: 2nd	8 km/h	5 mph	8 km/h	5 mph	0-14.9 km/h	0-9.3 mph
Maximum theoretical capacity	1300 mtph	1435 TPH	2177 mtph	2400 TPH	2177 mtph	2400 TPH
Tracks Assemblies:						
Width	356 mm	14"	356 mm	14"	457 mm	18"
Length on Ground	2249 mm	7'5"	2718 mm	8'11"	2718 mm	8'11"
Total Number of Track Pads	42		100		NA	
Dimensions:						
Operating Width	8 ft Screed	3269 mm	10'9"	—	—	—
	10 ft Screed	—	—	3327 mm	10'11"	3327 mm
Shipping Width*	8 ft Screed	3269 mm	10'9"	—	—	—
	10 ft Screed	—	—	3048 mm	10'0"	3048 mm
Height (less exhaust)	2623 mm	8'7"	2769 mm	9'1"	2769 mm	9'1"
Length (Screed**, Osc. pushroller)	5613 mm	18'5"	6579 mm	21'7"	6579 mm	21'7"
Turning Radius***	—	—	—	—	—	—
Hopper Capacity	5 m ³	177 ft ³	6.1 m ³	215 ft ³	6.1 m ³	215 ft ³
Auger Diameter	406 mm	16"	406 mm	16"	406 mm	16"
Paving Widths:						
8 ft Pavemaster B Screed						
Minimum w/cutoff shoes	1828 mm	6'0"	—	—	—	—
Maximum w/extensions	6096 mm	20'0"	—	—	—	—
10 ft Pavemaster B Screed						
Minimum w/cutoff shoes	—	—	2438 mm	8'0"	2438 mm	8'0"
Maximum w/extensions	—	—	9144 mm	30'0"	9144 mm	30'0"
8 ft Extend-A-Mat B Screed						
Minimum w/cutoff shoes	1828 mm	6'0"	—	—	—	—
Maximum w/extensions	4724 mm	15'6"	—	—	—	—
10 ft Extend-A-Mat B Screed						
Minimum w/cutoff shoes	—	—	2438 mm	8'0"	2438 mm	8'0"
Maximum w/extensions	—	—	7366 mm	24'2"	7366 mm	24'2"
Service Refill Capacities:						
Cooling system	31.5 L	8.3 U.S. gal	31.5 L	8.3 U.S. gal	31.5 L	8.3 U.S. gal
Fuel tank	227 L	60 U.S. gal	227 L	60 U.S. gal	227 L	60 U.S. gal
Hydraulic oil tank	189 L	50 U.S. gal	151.4 L	40 U.S. gal	151.4 L	40 U.S. gal

*Transport width hopper folded, no end gates.

**Pavemaster B on AP-1050B, Extend-A-Mat B on AP-1055B.

***Counter-rotates within own track length.

Features:

- **New variable width Extend-A-Mat B Screeds** or Pavemaster B fixed screeds available for all Barber-Greene paver models.
- **Designed With the Crew In Mind ...** for simplified, more efficient operation and unmatched access to operational controls and service areas.
- **Simplified Drive System ...** variable pump/motor propel system that covers all machine speed ranges required to increase paver productivity.
- **Material Handling System ...** fully hydrostatic drive provides smooth efficient operation with the capability to handle today's varied paving requirements.
- **Complete Range of Models ...** both rubber tired and crawler mounted pavers to meet any paving requirement.
- **Dependable Operation ...** job proven Barber-Greene design and engineering for mile after mile performance.
- **Service Accessibility ...** swing-out panels and decks provide generous access.
- **Complete Customer Support ...** unmatched in the paving industry.

Specifications
 ● Barber-Greene
 ● Rubber Tired Models

Asphalt Pavers



MODEL	BG-210B		BG-230	
Flywheel Power	80 kW	107 hp	80 kW	107 hp
Rated Engine RPM	2200		2200	
No. Cylinders	4		4	
Displacement	4 L	243 in ³	4 L	243 in ³
Engine Model	3054DIT		3054DIT	
Operating Weight:				
Tractor	8786 kg	19,395 lb	12 202 kg	26,900 lb
Pavemaster B Screed				
8 ft	1374 kg	3030 lb	1374 kg	3030 lb
10 ft	1656 kg	3650 lb	1656 kg	3650 lb
Extend-A-Mat B				
8 ft	2994 kg	6600 lb	2994 kg	6600 lb
10 ft	—	—	—	—
Extend-A-Mat B (wide plates)	10 ft	—	—	—
Speeds: Paving	0-83.9 mpm	0-275 fpm	0-76 mpm	0-250 fpm
Travel	0-21.7 kmph	0-13.5 mph	0-19 kmph	0-12 mph
Maximum theoretical capacity	1222 (t)/hr	1203 TPH	1801 (t)/hr	1773 TPH
Tires:				
Front (4) (Solid Rubber)	305 mm × 559 mm	12" × 22"	330 mm × 559 mm	13" × 22"
Rear (2)	14:00 × 24		16:00 × 24 sand rib	
Dimensions:				
Operating Width				
8 ft Screed	3226 mm	10'7"	3269 mm	10'9"
10 ft Screed	—	—	3327 mm	10'11"
Shipping Width*				
8 ft Screed	2502 mm	8'2.5"	2438 mm	8'0"
10 ft Screed	—	—	3048 mm	10'0"
Height (less exhaust)	2578 mm	8'5.5"	2620 mm	8'7 ¹ / ₈ "
Length (Extend-A-Mat B, pushroller)	5842 mm	19'2"	6477 mm	21'3"
Turning Radius	3048 mm	10'0"	2896 mm	9'6"
Wheelbase	2007 mm	6'7"	2336 mm	7'8"
Hopper Capacity	4.8 m ³	170 ft ³	5.5 m ³	195 ft ³
Auger Diameter	357 mm	14"	406 mm	16"
Paving Widths:				
8 ft Pavemaster B Screed				
Minimum w/cutoff shoes	1828 mm	6'0"	1828 mm	6'0"
Maximum w/extensions	4877 mm	16'0"	6096 mm	20'0"
10 ft Pavemaster B Screed				
Minimum w/cutoff shoes	—	—	—	—
Maximum w/extensions	—	—	—	—
8 ft Extend-A-Mat B Screed				
Minimum w/cutoff shoes	1828 mm	6'0"	1828 mm	6'0"
Maximum w/extensions	4724 mm	15'6"	4724 mm	15'6"
10 ft Extend-A-Mat B Screed				
Minimum w/cutoff shoes	—	—	2438 mm	8'0"
Maximum w/extensions	—	—	6147 mm	20'2"
Service Refill Capacities:				
Cooling system	19 L	5 U.S. gal	19 L	5 U.S. gal
Fuel tank	189 L	50 U.S. gal	189 L	50 U.S. gal
Hydraulic oil tank	178 L	47 U.S. gal	189 L	50 U.S. gal

*Shipping width with hoppers raised and without end gates.

Asphalt Pavers

Specifications

- Barber-Greene
- Rubber Tired Models



MODEL	BG-240B		BG-260C	
Flywheel Power	86 kW	115 hp	130 kW	174 hp
Rated Engine RPM	2310		2200	
No. Cylinders	4		6	
Displacement	4.5 L	276 in ³	6.6 L	403 in ³
Engine Model	JD4045T		3116TA	
Operating Weight:				
Tractor	11 896 kg	26,260 lb	16 170 kg	35,700 lb
Pavemaster B Screed	8 ft	—	—	—
	10 ft	1656 kg	1656 kg	3650 lb
Extend-A-Mat B	8 ft	—	—	—
	10 ft	3266 kg	3266 kg	7200 lb
Extend-A-Mat B (wide plates)	10 ft	—	3760 kg	8300 lb
Speeds: Paving	0-80.8 mpm	0-265 fpm	0-114 mpm	0-374 fpm
Travel	0-16.7 kmph	0-10.4 mph	0-23.5 kmph	0-14.5 mph
Maximum theoretical capacity	2936 (t)/hr	2890 TPH	2177 (t)/hr	2400 TPH
Tires:				
Front (4) (Solid Rubber)	406 mm × 559 mm	16" × 22"	406 mm × 559 mm	16" × 22"
Rear (2)	16:00 × 24		18:00 × 25, 16 ply sand rib	
Dimensions:				
Operating Width	8 ft Screed	—	—	—
	10 ft Screed	3327 mm	10'11"	3327 mm
Shipping Width*	8 ft Screed	—	—	—
	10 ft Screed	3048 mm	10'0"	3048 mm
Height (less exhaust)		2616 mm	8'7"	2769 mm
Length (Extend-A-Mat B, pushroller)		6731 mm	22'1"	6783 mm
Turning Radius		3048 mm	10'0"	2900 mm
Wheelbase		2184 mm	7'2"	2540 mm
Hopper Capacity		6.5 m ³	230 ft ³	5.8 m ³
Auger Diameter		406 mm	16"	406 mm
Paving Widths:				
8 ft Pavemaster B Screed				
Minimum w/cutoff shoes	—	—	—	—
Maximum w/extensions	—	—	—	—
10 ft Pavemaster B Screed				
Minimum w/cutoff shoes	2438 mm	8'0"	2438 mm	8'0"
Maximum w/extensions	6096 mm	20'0"	7925 mm	26'0"
8 ft Extend-A-Mat B Screed				
Minimum w/cutoff shoes	—	—	—	—
Maximum w/extensions	—	—	—	—
10 ft Extend-A-Mat B Screed				
Minimum w/cutoff shoes	2438 mm	8'0"	2438 mm	8'0"
Maximum w/extensions	5944 mm	19'6"	7290 mm	24'2"
Service Refill Capacities:				
Cooling system	35 L	9.2 U.S. gal	37 L	9.78 U.S. gal
Fuel tank	157 L	41 U.S. gal	265 L	70 U.S. gal
Hydraulic oil tank	159 L	42 U.S. gal	189 L	50 U.S. gal

*Shipping width with hoppers raised and without end gates.

Specifications
 ● Barber-Greene
 ● Track Models

Asphalt Pavers



MODEL		BG-225C		BG-245C	
Flywheel Power		90 kW	121 hp	130 kW	174 hp
Rated Engine RPM		2200		2200	
No. Cylinders		4		6	
Displacement		4 L	243 in ³	6.6 L	403 in ³
Engine Model		3054DIT		3116TA	
Operating Weight:					
Tractor		11 790 kg	25,990 lb	15 560 kg	34,300 lb
Pavemaster B Screed	8 ft	1374 kg	2850 lb	—	—
	10 ft	—	—	1472 kg	3650 lb
Extend-A-Mat B	8 ft	2994 kg	6600 lb	—	—
	10 ft	—	—	3266 kg	7200 lb
Extend-A-Mat B (wide plates)	10 ft	—	—	3760 kg	8300 lb
Speeds: Paving		0-67 mpm	0-220 fpm	0-65.6 mpm	0-215 fpm
Travel		0-8 kmph	0-5 mph	0-8 kmph	0-5 mph
Maximum theoretical capacity		1300 (t)/hr	1435 TPH	2177 (t)/hr	2400 TPH
Track Assemblies:					
Width		356 mm	14"	356 mm	14"
Length on ground		2244 mm	7'5"	2718 mm	8'11"
Total Number of Track Pads		92		100	
Dimensions:					
Operating Width	8 ft Screed	3269 mm	10'9"	—	—
	10 ft Screed	—	—	3327 mm	10'11"
Shipping Width*	8 ft Screed	2623 mm	8'7"	—	—
	10 ft Screed	—	—	3048 mm	10'0"
Height (less exhaust)		2623 mm	8'7"	2769 mm	9'1"
Length (Extend-A-Mat B Screed, pushroller)		5613 mm	18'5"	6579 mm	21'7"
Turning Radius**		—	—	—	—
Hopper Capacity		5 m ³	177 ft³	6.1 m ³	215 ft³
Auger Diameter		406 mm	16"	446 mm	16"
Paving Widths:					
8 ft Pavemaster B Screed					
Minimum w/cutoff shoes		1828 mm	6'0"	—	—
Maximum w/extensions		6096 mm	20'0"	—	—
10 ft Pavemaster B Screed					
Minimum w/cutoff shoes		—	—	2438 mm	8'0"
Maximum w/extensions		—	—	9144 mm	30'0"
8 ft Extend-A-Mat B Screed					
Minimum w/cutoff shoes		1828 mm	6'0"	—	—
Maximum w/extensions		4724 mm	15'6"	—	—
10 ft Extend-A-Mat B Screed					
Minimum w/cutoff shoes		—	—	2438 mm	8'0"
Maximum w/extensions		—	—	7366 mm	24'2"
Service Refill Capacities:					
Cooling system		31.5 L	8.3 U.S. gal	31.5 L	8.3 U.S. gal
Fuel tank		227 L	60 U.S. gal	227 L	60 U.S. gal
Hydraulic oil tank		189 L	50 U.S. gal	151.4 L	40 U.S. gal

*Shipping width with hoppers raised and without end gates.

**Counter rotates within own track length.

Asphalt Pavers

Specifications

- Barber-Greene
- Track Models



MODEL	BG-265B		BG-2455C	
Flywheel Power	145 kW	195 hp	130 kW	174 hp
Rated Engine RPM	2200		2200	
No. Cylinders	6		6	
Displacement	6.6 L	403 in ³	6.6 L	403 in ³
Engine Model	3116TA		3116TA	
Operating Weight:				
Tractor	15 119 kg	33,375 lb	16 103 kg	35,500 lb
Pavemaster B Screed	8 ft	—	—	—
	10 ft	1656 kg	1656 kg	3650 lb
Extend-A-Mat B	8 ft	—	—	—
	10 ft	3266 kg	3266 kg	7200 lb
Extend-A-Mat B (wide plates)	10 ft	3760 kg	3760 kg	8300 lb
Speeds: Paving	0-50 mpm	0-164 fpm	0-61 mpm	0-200 fpm
Travel	0-8.4 kmph	0-5.5 mph	0-14.9 kmph	0-9.3 mph
Maximum theoretical capacity	2936 (t)/hr	2890 TPH	2177 (t)/hr	2400 TPH
Track Assemblies:				
Width	457 mm	18"	457 mm	18"
Length on ground	3251 mm	10'8"	2718 mm	10'7"
Total Number of Track Pads	94		—	
Dimensions:				
Operating Width	8 ft Screed	—	—	—
	10 ft Screed	3327 mm	3327 mm	10'11"
Shipping Width*	8 ft Screed	—	—	—
	10 ft Screed	3048 mm	3048 mm	10'0"
Height (less exhaust)	2565 mm	8'5"	2769 mm	9'1"
Length (Extend-A-Mat B Screed, pushroller)	6505 mm	21'4"	6579 mm	21'7"
Turning Radius**	—		NA	
Hopper Capacity	5.8 m ³	206 ft ³	6.1 m ³	215 ft ³
Auger Diameter	406 mm	16"	406 mm	16"
Paving Widths:				
8 ft Pavemaster B Screed				
Minimum w/cutoff shoes	—	—	—	—
Maximum w/extensions	—	—	—	—
10 ft Pavemaster B Screed				
Minimum w/cutoff shoes	2438 mm	8'0"	2438 mm	8'0"
Maximum w/extensions	9754 mm	32'0"	9144 mm	30'0"
8 ft Extend-A-Mat B Screed				
Minimum w/cutoff shoes	—	—	—	—
Maximum w/extensions	—	—	—	—
10 ft Extend-A-Mat B Screed				
Minimum w/cutoff shoes	2438 mm	8'0"	2438 mm	8'0"
Maximum w/extensions	7366 mm	24'2"	7366 mm	24'2"
Service Refill Capacities:				
Cooling system	34.8 L	9.2 U.S. gal	31.5 L	8.3 U.S. gal
Fuel tank	303 L	80 U.S. gal	227 L	60 U.S. gal
Hydraulic oil tank	107.7 L	45.1 U.S. gal	151.4 L	40 U.S. gal

*Shipping width with hoppers raised and without end gates.

**Counter rotates within own track length.

Production in tons/hr with 1" compacted mat

Speed		Paving Width					
fpm	6'0"	7'0"	8'0"	9'0"	10'0"	11'0"	12'0"
10	22	26	29	33	37	40	44
20	44	51	58	66	73	80	88
30	66	77	87	99	110	120	131
40	88	102	116	131	146	161	175
50	110	129	145	164	183	201	219



Features:

- **Superior maneuverability.** All 700 Series machines are equipped with four wheel steering and three steering modes which provide unmatched maneuverability on the job ... turn radius under 4267 mm/14 ft.
- **Unmatched traction.** Four wheel drive on the BG-730 and BG-750 with differential locks on the drive axles combined with engine horsepower and weight distribution make the toughest widening jobs easy.
- **High capacity conveyors.** All machines have high capacity 762 mm/30 in. wide belt conveyors for handling large projects.
- **Quick shift conveyor.** The BG-730 and BG-750 conveyors are equipped with a dual drive system allowing rapid change of direction. Conveyors on all units shift hydraulically from side to side.
- **Power dump front hopper lip.** Front lip on hopper hydraulically lifts to clean out material after truck dumps, reducing hand work.
- **Sliding operator's console.** Operator's console slides from side to side providing rapid change of station location.

MODEL

BG-730

Flywheel Power	111 kW	149 hp
Rated Engine RPM	2200	
No. Cylinders	6	
Displacement	6 L	365 in ³
Engine Model	3056T	
Operating Weight	14 062 kg	31,000 lb
Speeds: Paving	0-98 mpm	0-320 fpm
Travel	0-24.1 kmph	0-15 mph
Maximum theoretical capacity	3658 (t)/hr	3600 TPH
Tires	15.00 × 22.5	
Dimensions:		
Length with pushroller	7820 mm	25'8"
Operating height	2921 mm	9'7"
Shipping height	2578 mm	8'5.5"
Shipping width	3048 mm	10'0"
Turning Radius	3962 mm	13'0"
Wheelbase	4572 mm	15'0"
Hopper Capacity	10 m ³	80 ft³
Truck entry width	2845 mm	9'4"
Laydown widths	to 3048 mm	to 10'
Service Refill Capacities:		
Cooling system	28.4 L	7.7 U.S. gal
Fuel tank	151.4 L	40 U.S. gal
Hydraulic oil tank	151.4 L	40 U.S. gal

Features:

- **Attaches easily to most pavers.**
- **Allows for continuous paving operations.**
- **High capacity conveyor** with 1905 mm (75") discharge height provides full power hopper loading.
- **Foot shaft combining augers** provide a wide throat for pick up off-center and extra wide windrows.

- **Wide throat** allows machine to pickup windrows from bottom dump trailers, end dump trailers or trucks.
- **Height adjustable scraper** mounted behind combining augers maintains a clean path for paver.
- **Three point suspension** allows machine to closely follow road contours.



MODEL	BG-650	
Flywheel Power	80 kW	107 hp
Engine RPM	2100	
Operating Weight	7973 kg	17,600 lb
Engine	3054DIT	
Displacement	4 L	243 in ³
General Dimensions		
Operating height	2946 mm	9'8"
Shipping height	2946 mm	9'8"
Length	4267 mm	14'0"
Conveyor:		
Maximum theoretical capacity	1829 (t)/hr	1800 TPH
Discharge height	1905 mm	6'2"
Width	1524 mm	5'0"
Lift	178 mm	7"
Tires:		
Front (2)	178 mm × 559 mm	7" × 22" Solid Rubber
Rear (2)	8.25 × 15	8.25 × 15
Service Refill Capacities:		
Fuel	151.4 L	40 U.S. gal



Features:

- **Designed with optimum horsepower-to-weight ratio** for best operating economy and peak performance.
- **Hydrostatic transmission** allows infinitely variable speeds in both forward and reverse.
- **Drum-drive units** feature a unique, Cat-designed hydraulic flow divider valve (blade-equipped CS-323C) or dual pump and circuit arrangement that delivers positive tractive effort to both drum and rear wheels, regardless of underfooting. This increases the machine's ability to maneuver in a wide variety of soil types and conditions and improves gross gradeability.
- **NoSPIN high traction differential** is standard on all units for best traction of rear tires. (Except CS-533C.)
- **Routine maintenance** simplified by grouped service points and easy, ample access to service areas.
- **Operator comfort** provided by full-width padded seats or adjustable bucket seats for all day productivity. All machine controls and instrumentation are within easy sight and reach. Unobstructed visibility increases work area productivity.
- **ROPS (Roll Over Protective Structure)** standard on all units. Enclosed cabs with EROPS rating available as an option to provide all-weather comfort and productivity.
- **Oil bath lubrication** increases bearing service life and eliminates daily maintenance.
- **High centrifugal force and amplitude** work together for a highly productive compactor.

MODEL

CS-323C

Flywheel Power	60 kW	80 hp
Rated Engine RPM	2200	
No. Cylinders	4	
Displacement	4 L	243 in ³
Engine Model	3054 DINA	
Speeds:		
Forward	1	
Reverse	1	
Max. Speed (For./Rev.)	8.9 km/h	5.5 mph
Operating Weight	4540 kg	9985 lb
Shipping Weight	4395 kg	9670 lb
Drive	Drum/rear wheel	
Gradeability	49%	
Steering:		
Inside radius	2625 mm	8'6"
Outside radius	3895 mm	12'8"
Steering angle	±38°	
Vibratory System:		
Ecc. Weight Drive	Hydraulic	
Frequency	35 Hz	2100 vpm
Amplitude Settings	1	
Centrifugal Force (Max.)	66.8 kN	15,000 lb
General Dimensions:		
Overall width	1395 mm	4'6"
Drum width	1270 mm	4'2"
Drum diameter	1016 mm	3'4"
Tires	11.2 × 24 6-ply	
Overall height	2514 mm	8'3"
Wheel to drum	2240 mm	7'4"
Overall length	4095 mm	13'4"
Curb Clearance	347 mm	13.7"
Service Refill Capacities:		
Fuel tank	144 L	38 U.S. gal
Crankcase	7.6 L	2 U.S. gal
Hydraulic fluid	49.2 L	13 U.S. gal



MODEL	CS-431C		CS-433C		CS-531C*	
Flywheel Power	80 kW	107 hp	80 kW	107 hp	108 kW	145 hp
Rated Engine RPM	2200		2200		2200	
No. Cylinders	4		4		6	
Displacement	4 L	243 in ³	4 L	243 in ³	6.6 L	403 in ³
Engine Model	3054T		3054T		3116T	
Speeds:						
Forward	2		2		2	
Reverse	2		2		2	
Max. Speed (For./Rev.)	12.8 km/h	0-8 mph	12.8 km/h	0-8 mph	12.8 km/h	0-8 mph
Operating Weight	6526 kg	14,375 lb	6670 kg	14,675 lb	9300 kg	20,450 lb
Shipping Weight	6243 kg	13,750 lb	6379 kg	14,080 lb	9090 kg	20,000 lb
Drive	Rear wheel		Drum/rear wheel		Rear wheel	
Steering:						
Inside radius	3008 mm	9'10"	3008 mm	9'10"	3912 mm	12'10"
Outside radius	4684 mm	15'4"	4684 mm	15'4"	6325 mm	20'9"
Steering angle	±37°		±37°		±30°	
Vibratory System:						
Ecc. Weight Drive	Hydraulic		Hydraulic		Hydraulic	
Frequency	30 Hz	1800 rpm	30 Hz	1800 rpm	30 Hz	1800 rpm
Amplitude Settings	2		2		2	
Centrifugal Force						
High amplitude	12 727 kg	28,000 lb	12 727 kg	28,000 lb	24 060 kg	53,100 lb
Low amplitude	6273 kg	13,800 lb	6273 kg	13,800 lb	12 030 kg	26,550 lb
General Dimensions:						
Overall width	1905 mm	6'3"	1905 mm	6'3"	2438 mm	8'0"
Drum width	1680 mm	5'6"	1680 mm	5'6"	2130 mm	7'0"
Drum diameter	1220 mm	4'0"	1220 mm	4'0"	1520 mm	5'0"
Tires	14.9" × 24" 6-ply		14.9" × 24" 6-ply		23.1" × 26" 8-ply	
Overall height	2900 mm	9'6"	2900 mm	9'6"	2667 mm	8'9"
Wheel to drum	2583 mm	8'6"	2583 mm	8'6"	2740 mm	9'0"
Overall length	4825 mm	15'10"	4825 mm	15'10"	5258 mm	17'3"
Curb clearance	380 mm	15"	380 mm	15"	483 mm	1'7"
Service Refill Capacities:						
Fuel tank	167 L	44 U.S. gal	167 L	44 U.S. gal	220 L	58 U.S. gal
Crankcase	6.8 L	1.8 U.S. gal	6.8 L	1.8 U.S. gal	20 L	6.4 U.S. gal
Hydraulic fluid	71 L	18.7 U.S. gal	71 L	18.7 U.S. gal	110 L	29 U.S. gal

*Not offered in the United States.

Smooth Drum Vibratory Soil Compactors

Specifications



MODEL	CS-533C*		CS-563C		CS-573C*		CS-583C	
Flywheel Power	108 kW	145 hp	108 kW	145 hp	108 kW	145 hp	108 kW	145 hp
Rated Engine RPM	2200		2200		2200		2200	
No. Cylinders	6		6		6		6	
Displacement	6.6 L	403 in ³	6.6 L	403 in ³	6.6 L	403 in ³	6.6 L	403 in ³
Engine Model	3116T		3116T		3116T		3116T	
Speeds:								
Forward	2		2		2		2	
Reverse	2		2		2		2	
Max. Speed (For./Rev.)	12.8 km/h	0-8 mph	12.8 km/h	0-8 mph	12.8 km/h	8 mph	12.8 km/h	8 mph
Operating Weight	9397 kg	20,700 lb	11 215 kg	24,700 lb	13 300 kg	29,300 lb	15 460 kg	34,030 lb
Shipping Weight	9284 kg	20,450 lb	10 900 kg	24,000 lb	13 010 kg	28,690 lb	15 140 kg	33,380 lb
Drive	Drum/rear wheel		Drum/rear wheel		Drum/rear wheel		Drum/rear wheel	
Steering:								
Inside radius	3912 mm	12'10"	3912 mm	12'10"	3800 mm	12'6"	3800 mm	12'6"
Outside radius	6325 mm	20'9"	6325 mm	20'9"	6170 mm	20'3"	6170 mm	20'3"
Steering angle	±30°		±30°		±30°		±30°	
Vibratory System:								
Ecc. Weight Drive	Hydraulic		Hydraulic		Hydraulic		Hydraulic	
Frequency	30 Hz	1800 vpm	30 Hz	1800 vpm	30 Hz	1800 vpm	30 Hz	1800 vpm
Amplitude Settings	2		2		2		2	
Centrifugal Force								
High amplitude	24 060 kg	53,100 lb	24 060 kg	53,100 lb	31 750 kg	70,000 lb	31 750 kg	70,000 lb
Low amplitude	12 030 kg	26,550 lb	12 030 kg	26,550 lb	16 675 kg	36,760 lb	16 675 kg	36,760 lb
General Dimensions:								
Overall width	2438 mm	8'0"	2438 mm	8'0"	2508 mm	8'3"	2508 mm	8'3"
Drum width	2130 mm	7'0"	2130 mm	7'0"	2130 mm	7'0"	2130 mm	7'0"
Drum diameter	1520 mm	5'0"	1520 mm	5'0"	1520 mm	5'0"	1520 mm	5'0"
Tires	23.1" × 26" 8-ply		23.1" × 26" 8-ply		23.1" × 26" 8-ply		23.1" × 26" 8-ply	
Overall height	2667 mm	8'9"	2997 mm	9'10"	2997 mm	9'10"	2997 mm	9'10"
Wheel to drum	2740 mm	9'0"	2740 mm	9'0"	2740 mm	9'0"	2740 mm	9'0"
Overall length	5258 mm	17'3"	5400 mm	17'9"	5400 mm	17'9"	5400 mm	17'9"
Curb clearance	483 mm	1'7"	483 mm	1'7"	483 mm	1'7"	483 mm	1'7"
Service Refill Capacities:								
Fuel tank	220 L	58 U.S. gal	220 L	58 U.S. gal	220 L	58 U.S. gal	220 L	58 U.S. gal
Crankcase	20 L	5.4 U.S. gal	20 L	5.4 U.S. gal	20 L	5.4 U.S. gal	20 L	5.4 U.S. gal
Hydraulic fluid	110 L	29 U.S. gal	110 L	29 U.S. gal	110 L	29 U.S. gal	110 L	29 U.S. gal

*Not offered in the United States.

MODEL AND MACHINE PASSES	AVERAGE SPEED MPH	COMPACTED LIFT THICKNESS								
		150 mm m ³ /hr	6 in yd ³ /hr	200 mm m ³ /hr	8 in yd ³ /hr	250 mm m ³ /hr	10 in yd ³ /hr	300 mm m ³ /hr	12 in yd ³ /hr	
CS-323C	3	2.5	249.5	326.0	332.7	434.7	415.9	543.3	499.0	652.0
	3	3.0	299.4	391.2	399.2	521.6	499.0	652.0	598.8	782.4
	3	3.5	349.3	456.4	465.8	608.5	582.2	760.7	698.7	912.8
	3	4.0	399.2	521.6	532.3	695.5	665.4	869.3	798.5	1043.2
	4	2.5	187.1	244.5	249.5	326.0	311.9	407.5	374.3	489.0
	4	3.0	224.6	293.4	299.4	391.2	374.3	489.0	449.1	586.8
	4	3.5	262.0	342.3	349.3	456.4	436.7	570.5	524.0	684.6
	4	4.0	299.4	391.2	399.2	521.6	499.0	652.0	598.8	782.4
	5	2.5	149.7	195.6	199.6	260.8	249.5	326.0	299.4	391.2
	5	3.0	179.7	234.7	239.5	313.0	299.4	391.2	359.3	469.4
	5	3.5	209.6	273.8	279.5	365.1	349.3	456.4	419.2	547.7
	5	4.0	239.5	313.0	319.4	417.3	399.2	521.6	479.1	625.9
CS-431C	3	2.5	343.1	448.3	457.5	597.7	571.8	747.1	686.2	896.5
	3	3.0	411.7	537.9	548.9	717.2	686.2	896.5	823.4	1075.8
	3	3.5	480.3	627.6	640.4	836.7	800.5	1045.9	960.7	1255.1
	3	4.0	548.9	717.2	731.9	956.3	914.9	1195.3	1097.9	1434.4
	4	2.5	257.3	336.2	343.1	448.3	428.9	560.3	514.6	672.4
	4	3.0	308.8	403.4	411.7	537.9	514.6	672.4	617.6	806.9
	4	3.5	360.2	470.7	480.3	627.6	600.4	784.4	720.5	941.3
	4	4.0	411.7	537.9	548.9	717.2	686.2	896.5	823.4	1075.8
	5	2.5	205.9	269.0	274.5	358.6	343.1	448.3	411.7	537.9
	5	3.0	247.0	322.7	329.4	430.3	411.7	537.9	494.1	645.5
	5	3.5	288.2	376.5	384.3	502.0	480.3	627.6	576.4	753.1
	5	4.0	329.4	430.3	439.2	573.8	548.9	717.2	658.7	860.6
CS-433C	3	2.5	343.1	448.3	457.5	597.7	571.8	747.1	686.2	896.5
	3	3.0	411.7	537.9	548.9	717.2	686.2	896.5	823.4	1075.8
	3	3.5	480.3	627.6	640.4	836.7	800.5	1045.9	960.7	1255.1
	3	4.0	548.9	717.2	731.9	956.3	914.9	1195.3	1097.9	1434.4
	4	2.5	257.3	336.2	343.1	448.3	428.9	560.3	514.6	672.4
	4	3.0	308.8	403.4	411.7	537.9	514.6	672.4	617.6	806.9
	4	3.5	360.2	470.7	480.3	627.6	600.4	784.4	720.5	941.3
	4	4.0	411.7	537.9	548.9	717.2	686.2	896.5	823.4	1075.8
	5	2.5	205.9	269.0	274.5	358.6	343.1	448.3	411.7	537.9
	5	3.0	247.0	322.7	329.4	430.3	411.7	537.9	494.1	645.5
	5	3.5	288.2	376.5	384.3	502.0	480.3	627.6	576.4	753.1
	5	4.0	329.4	430.3	439.2	573.8	548.9	717.2	658.7	860.6
CS-533C	3	2.5	436.7	570.5	582.2	760.7	727.8	950.8	873.3	1141.0
CS-563C	3	3.0	524.0	684.6	698.7	912.8	873.3	1141.0	1048.0	1369.2
CS-573C	3	3.5	611.3	798.7	815.1	1064.9	1018.9	1331.2	1222.6	1597.4
CS-583C	3	4.0	698.7	912.8	931.5	1217.1	1164.4	1521.3	1397.3	1825.6
	4	2.5	327.5	427.9	436.7	570.5	545.8	713.1	655.0	855.8
	4	3.0	393.0	513.5	524.0	684.6	655.0	855.8	786.0	1026.9
	4	3.5	458.5	599.0	611.3	798.7	764.2	998.4	917.0	1198.1
	4	4.0	524.0	684.6	698.7	912.8	873.3	1141.0	1048.0	1369.2
	5	2.5	262.0	342.3	349.3	456.4	436.7	570.5	524.0	684.6
	5	3.0	314.4	410.8	419.2	547.7	524.0	684.6	628.8	821.5
	5	3.5	366.8	479.2	489.1	639.0	611.3	798.7	733.6	958.4
	5	4.0	419.2	547.7	558.9	730.2	698.7	912.8	838.4	1095.4



Features:

- **Designed with optimum horsepower-to-weight ratio** for best operating economy and peak performance.
- **All units feature a unique, Cat-designed hydraulic flow divider valve (CP-323C) or dual pump and circuit arrangement** that delivers positive tractive effort to both drum and rear wheels, regardless of underfooting. This increases the machine's ability to maneuver in a wide variety of soil types and conditions and improves gross gradeability.
- **NoSPIN high traction differential** is standard on all units for best traction of rear tires. (Except CP-533C.)
- **Optional Heavy-duty front-mounted blade** with reversible cutting edge is available to allow backfilling and leveling during compaction.
- **Routine maintenance** simplified by grouped service points and easy access to service areas.
- **Operator comfort** provided by full-width padded seats or adjustable bucket seats for all day productivity. All machine controls and instrumentation are within easy sight and reach. Unobstructed visibility increases work area productivity.
- **ROPS (Roll Over Protective Structure)** standard on all units. Enclosed cabs with EROPS rating available as an option to provide all-weather comfort and productivity.
- **Oil bath lubrication** increases bearing service life and eliminates daily maintenance.
- **High centrifugal force and amplitude** work together for a highly productive compactor.
- **Adjustable jaw-type cleaner bar** keeps drums clean between pads during forward and reverse movement.

MODEL

CP-323C

Flywheel Power	60 kW	80 hp
Rated Engine RPM	2200	
No. Cylinders	4	
Displacement	4 L	243 in ³
Engine Model	3054 DINA	
Speeds:		
Forward	1	
Reverse	1	
Max. Speed (For./Rev.)	8.9 km/h	5.5 mph
Operating Weight	4745 kg	10,440 lb
Shipping Weight	4600 kg	10,125 lb
Drive	Drum/rear wheel	
Steering:		
Inside radius	2625 mm	8'7.3"
Outside radius	3895 mm	12'9.3"
Steering angle	±38°	
Vibratory System:		
Ecc. Weight Drive	Hydraulic	
Frequency	35 Hz	2100 vpm
Amplitude Settings	1	
Centrifical Force (Max.)	66.8 kN	15,000 lb
General Dimensions:		
Overall width w/blade	1575 mm	5'2"
Overall width w/o blade	1393 mm	4'7"
Drum width	1270 mm	4'2"
Drum diameter over pads	1016 mm	3'4"
Tires	11.2 × 24 6-ply	
Overall height	2514 mm	8'3"
Wheel to drum	2240 mm	7'4.2"
Overall length	4095 mm	13'5.2"
Curb Clearance	347 mm	13.7"
Service Refill Capacities:		
Fuel Tank	144 L	38 U.S. gal
Crankcase	7.6 L	2 U.S. gal
Hydraulic fluid	49.2 L	13 U.S. gal



MODEL	CP-433C		CP-533C*		CP-563C	
Flywheel Power	80 kW	107 hp	108 kW	145 hp	108 kW	145 hp
Rated Engine RPM	2500		2200		2200	
No. Cylinders	4		6		6	
Displacement	4 L	243 in ³	6.6 L	403 in ³	6.6 L	403 in ³
Engine Model	3054T		3116T		3116T	
Speeds:						
Forward	2		2		2	
Reverse	2		2		2	
Max. Speed (For./Rev.)	13.3 km/h	0-8 mph	12.8 km/h	0-8 mph	12.8 km/h	0-8 mph
Operating Weight	6912 kg	15,225 lb	10 760 kg	23,700 lb	11 670 kg	25,700 lb
Shipping Weight	6628 kg	14,600 lb	10 646 kg	23,450 lb	11 360 kg	25,000 lb
Drive	Drum/rear wheel		Drum/rear wheel		Drum/rear wheel	
Steering:						
Inside radius	3008 mm	9'10"	3912 mm	12'10"	3912 mm	12'10"
Outside radius	4684 mm	15'4"	6325 mm	20'9"	6325 mm	20'9"
Steering angle	±37°		±30°		±30°	
Vibratory System:						
Ecc. Weight Drive	Hydraulic		Hydraulic		Hydraulic	
Frequency	30 Hz	1800 vpm	30 Hz	1800 rpm	30 Hz	1800 vpm
Amplitude Settings	2		2		2	
Centrifugal Force						
Low amplitude	6273 kg	13,800 lb	31 750 kg	70,000 lb	31 750 kg	70,000 lb
High amplitude	12 727 kg	28,000 lb	16 675 kg	36,760 lb	16 675 kg	36,760 lb
General Dimensions:						
Overall width w/blade	1981 mm	6'6"	2740 mm	9'0"	2740 mm	9'0"
Overall width w/o blade	1905 mm	6'3"	2440 mm	8'0"	2440 mm	8'0"
Drum width	1680 mm	5'6"	2130 mm	7'0"	2130 mm	7'0"
Drum diameter over pads	1220 mm	4'0"	1549 mm	5'1"	1549 mm	5'1"
Tires	14.9" × 24" 6-ply		23.1" × 26" 8-ply		23.1" × 26" 8-ply	
Overall height	2900 mm	9'6"	2667 mm	8'9"	2997 mm	9'10"
Wheel to drum	2583 mm	8'6"	2740 mm	9'10"	2740 mm	9'0"
Overall length	4825 mm	15'10"	5258 mm	17'3"	5258 mm	17'3"
Curb clearance	380 mm	15"	483 mm	1'7"	483 mm	1'7"
Service Refill Capacities:						
Fuel tank	167 L	44 U.S. gal	220 L	58 U.S. gal	220 L	58 U.S. gal
Crankcase	6.8 L	1.8 U.S. gal	20 L	5.4 U.S. gal	20 L	5.4 U.S. gal
Hydraulic fluid	71 L	18.7 U.S. gal	110 L	29 U.S. gal	110 L	29 U.S. gal

*Not offered in United States.

**Padded Drum Vibratory
Soil Compactors**

Production Table

MODEL AND MACHINE PASSES	AVERAGE SPEED MPH	COMPACTED LIFT THICKNESS								
		150 mm m ³ /hr	6 in yd ³ /hr	200 mm m ³ /hr	8 in yd ³ /hr	250 mm m ³ /hr	10 in yd ³ /hr	300 mm m ³ /hr	12 in yd ³ /hr	
CP-323C	3	2.5	249.5	326.0	332.7	434.7	415.9	543.3	499.0	652.0
	3	3.0	299.4	391.2	399.2	521.6	499.0	652.0	598.8	782.4
	3	3.5	349.3	456.4	465.8	608.5	582.2	760.7	698.7	912.8
	3	4.0	399.2	521.6	532.3	695.5	665.4	869.3	798.5	1043.2
	4	2.5	187.1	244.5	249.5	326.0	311.9	407.5	374.3	489.0
	4	3.0	224.6	293.4	299.4	391.2	374.3	489.0	449.1	586.8
	4	3.5	262.0	342.3	349.3	456.4	436.7	570.5	524.0	684.6
	4	4.0	299.4	391.2	399.2	521.6	499.0	652.0	598.8	782.4
	5	2.5	149.7	195.6	199.6	260.8	249.5	326.0	299.4	391.2
	5	3.0	179.7	234.7	239.5	313.0	299.4	391.2	359.3	469.4
	5	3.5	209.6	273.8	279.5	365.1	349.3	456.4	419.2	547.7
	5	4.0	239.5	313.0	319.4	417.3	399.2	521.6	479.1	625.9
CP-433C	3	2.5	343.1	448.3	457.5	597.7	571.8	747.1	686.2	896.5
	3	3.0	411.7	537.9	548.9	717.2	686.2	896.5	823.4	1075.8
	3	3.5	480.3	627.6	640.4	836.7	800.5	1045.9	960.7	1255.1
	3	4.0	548.9	717.2	731.9	956.3	914.9	1195.3	1097.9	1434.4
	4	2.5	257.3	336.2	343.1	448.3	428.9	560.3	514.6	672.4
	4	3.0	308.8	403.4	411.7	537.9	514.6	672.4	617.6	806.9
	4	3.5	360.2	470.7	480.3	627.6	600.4	784.4	720.5	941.3
	4	4.0	411.7	537.9	548.9	717.2	686.2	896.5	823.4	1075.8
	5	2.5	205.9	269.0	274.5	358.6	343.1	448.3	411.7	537.9
	5	3.0	247.0	322.7	329.4	430.3	411.7	537.9	494.1	645.5
	5	3.5	288.2	376.5	384.3	502.0	480.3	627.6	576.4	753.1
	5	4.0	329.4	430.3	439.2	573.8	548.9	717.2	658.7	860.6
CP-563C	3	2.5	436.7	570.5	582.2	760.7	727.8	950.8	873.3	1141.0
	3	3.0	524.0	684.6	698.7	912.8	873.3	1141.0	1048.0	1369.2
	3	3.5	611.3	798.7	815.1	1064.9	1018.9	1331.2	1222.6	1597.4
	3	4.0	698.7	912.8	931.5	1217.1	1164.4	1521.3	1397.3	1825.6
	4	2.5	327.5	427.9	436.7	570.5	545.8	713.1	655.0	855.8
	4	3.0	393.0	513.5	524.0	684.6	655.0	855.8	786.0	1026.9
	4	3.5	458.5	599.0	611.3	798.7	764.2	998.4	917.0	1198.1
	4	4.0	524.0	684.6	698.7	912.8	873.3	1141.0	1048.0	1369.2
	5	2.5	262.0	342.3	349.3	456.4	436.7	570.5	524.0	684.6
	5	3.0	314.4	410.8	419.2	547.7	524.0	684.6	628.8	821.5
	5	3.5	366.8	479.2	489.1	639.0	611.3	798.7	733.6	958.4
	5	4.0	419.2	547.7	558.9	730.2	698.7	912.8	838.4	1095.4



Features:

- **Direct hydrostatic drive to both drums** provides dependable, responsive propulsion effort and maximum gradeability.
- **On larger units, vibration automatically ceases before machine comes to a stop** to help produce a smooth, flawless mat surface.
- **Flexible gear coupling between the vibratory motor and shaft** increase motor life.
- **Larger units** feature multiple operator positions with operator positioned away from engine noise and heat.
- **Exhaust systems** direct fumes away from operator.
- **Smaller units** feature padded seats and unobstructed visibility of all rolling edges.
- **Clean frame design and close side clearances** allow compactors to work close to curbs, walls and other obstructions.
- **External plumbing of all motors and brakes** makes maintenance easy. All servicing is possible from ground level.
- **Large, rust-proof water tanks and pressure spray system** provide hours of reliable operation between fill-ups.

MODEL

CB-214C

Flywheel Power	28 kW	37 hp
Rated Engine RPM	2400	
No. Cylinders	2	
Displacement	1.72 L	105 in³
Engine Model	Hatz 2M41	
Speeds:		
Forward	1	
Reverse	1	
Max. Speed (For./Rev.)	10.5 km/h	0-6.5 mph
Operating Weight	2320 kg	5115 lb
Shipping Weight	2110 kg	4652 lb
Drive	Hydraulic	
Gradeability	35%	
Operator Position(s)	Single/bucket seat	
Steering:		
Inside radius	2525 mm	8'3"
Outside radius	3525 mm	11'7"
Steering angle	±32°	
Vibratory System:		
Ecc. Weight Drive	Hydraulic	
Frequency	60 Hz	3600 vpm
Amplitude Settings	1	
Centrifugal Force per drum (Max.)	25.4 kN	5715 lb
General Dimensions:		
Overall width	1090 mm	3'7"
Drum width	1000 mm	3'3.4"
Drum diameter	700 mm	2'3.5"
Overall height (ROPS)	7500 mm	8'2"
Wheelbase	1700 mm	5'7"
Overall length	2430 mm	7'11.5"
Curb clearance	400 mm	15.75"
Ground clearance	250 mm	10"
Service Refill Capacities:		
Fuel tank	53 L	14 U.S. gal
Crankcase	4.5 L	1.19 U.S. gal
Hydraulic tank	29 L	7.7 U.S. gal
Sprinkler water	160 L	42 U.S. gal

Dual Drum Vibratory Asphalt Compactors

Specifications



MODEL	CB-224C		CB-434C		CB-534C		CB-634C	
Flywheel Power	28 kW	37 hp	60 kW	80 hp	80 kW	107 hp	108 kW	145 hp
Rated Engine RPM	2400		2200		2200		2200	
No. Cylinders	2		4		4		6	
Displacement	1.72 L	104.7 in ³	4 L	243 in ³	4 L	243 in ³	6.6 L	403 in ³
Engine Model	Hatz 2M41		3054		3054T		3116T	
Speeds:								
Forward	1		1		2		2	
Reverse	1		1		2		2	
Max. Speed (For./Rev.)	10.5 km/h	0-6.5 mph	11.6 km/h	0-7.2 mph	11 km/h	0-7 mph	12.2 km/h	0-7.6 mph
Operating Weight	2420 kg	5335 lb	6485 kg	14,300 lb	9195 kg	20,270 lb	11 680 kg	25,750 lb
Shipping Weight	2190 kg	4872 lb	5950 kg	13,120 lb	8495 kg	18,728 lb	10 855 kg	23,931 lb
Drive	Hydraulic		Hydraulic		Hydraulic		Hydraulic	
Gradeability	35%		—		—		—	
Operator Position(s)	Single/bucket seat		Swivel/bucket seat		Swivel/bucket seat		Swivel/bucket seat	
Steering:								
Inside radius	2425 mm	7'11.5"	3404 mm	11'2"	4165 mm	13'8"	4318 mm	14'2"
Outside radius	3625 mm	11'11"	4832 mm	15'10.25"	5865 mm	19'3"	6655 mm	21'10"
Steering angle	±32°		±35°		±35°		±32°	
Vibratory System:								
Ecc. Weight Drive	Hydraulic		Hydraulic		Hydraulic		Hydraulic	
Frequency	60 Hz	3600 vpm	48 Hz	2900 vpm	42 Hz	2520 vpm	42 Hz	2520 vpm
Amplitude Settings	1		3		3		3	
Centrifugal Force per drum (Max.)	28.6 kN	6570 lb	74.7 kN	16,800 lb	118.1 kN	26,550 lb	118.1 kN	26,550 lb
General Dimensions:								
Overall width	1300 mm	4'3"	1613 mm	5'4"	1850 mm	6'1"	2311 mm	7'7"
Drum width	1200 mm	3'11.2"	1422 mm	4'8"	1700 mm	5'7"	2130 mm	7'0"
Drum diameter	700 mm	2'3.5"	1100 mm	3'7.5"	1300 mm	4'3"	1300 mm	4'3"
Overall height	1640 mm	5'4"	2261 mm	7'5"	2410 mm	7'11"	2362 mm	7'9"
Wheelbase	1700 mm	5'7"	2616 mm	8'7"	3150 mm	10'4"	3150 mm	10'4"
Overall length	2430 mm	7'11.5"	4191 mm	13'9"	4940 mm	16'2"	4953 mm	16'3"
Curb clearance	400 mm	15.75"	381 mm	15"	416 mm	16"	416 mm	16"
Ground clearance	250 mm	10"	381 mm	15"	416 mm	16"	416 mm	16"
Service Refill Capacities:								
Fuel tank	53 L	14 U.S. gal	144 L	38 U.S. gal	208 L	55 U.S. gal	208 L	55 U.S. gal
Crankcase	4.5 L	1.19 U.S. gal	7.6 L	2 U.S. gal	7.6 L	2 U.S. gal	17 L	4.5 U.S. gal
Hydraulic tank	29 L	7.7 U.S. gal	49.2 L	13 U.S. gal	60 L	15 U.S. gal	60 L	15 U.S. gal
Sprinkler water	160 L	42 U.S. gal	666 L	176 U.S. gal	950 L	264 U.S. gal	1200 L	317 U.S. gal



CB-214C



CB-224C



CB-434B*

MODEL	CB-214C		CB-224C		CB-434B*	
Flywheel Power	28 kW	37 hp	28 kW	37 hp	60 kW	80 hp
Rated Engine RPM	2400		2400		2200	
No. Cylinders	2		2		4	
Displacement	1.72 L	105 in ³	1.72 L	104.7 in ³	4 L	243 in ³
Engine Model	Hatz 2M41		Hatz 2M41		3054	
Speeds:						
Forward	1		1		1	
Reverse	1		1		1	
Max. Speed (For./Rev.)	10.5 km/h	0-6.5 mph	10.5 km/h	0-6.5 mph	11.6 km/h	0-7.2 mph
Operating Weight	2320 kg	5115 lb	2420 kg	5335 lb	6595 kg	14,540 lb
Shipping Weight	2110 kg	4652 lb	2190 kg	4872 lb	6059 kg	13,350 lb
Drive	Hydraulic		Hydraulic		Hydraulic	
Gradeability	35%		35%		—	
Operator Position(s)	Single/bucket seat		Single/bucket seat		Swivel/bucket seat	
Steering:						
Inside radius	2525 mm	8'3"	2425 mm	7'11.5"	3410 mm	11'2.25"
Outside radius	3525 mm	11'7"	3625 mm	11'11"	4832 mm	15'10.25"
Steering angle	±32°		±32°		±35°	
Vibratory System:						
Ecc. Weight Drive	Hydraulic		Hydraulic		Hydraulic	
Frequency	60 Hz	3600 vpm	60 Hz	3600 vpm	48 Hz	2900 vpm
Amplitude Settings	1		1		3	
Centrifugal Force per drum (Max.)	25.4 kN	5715 lb	28.6 kN	6570 lb	7640 kg	16,800 lb
General Dimensions:						
Overall width	1090 mm	3'7"	1300 mm	4'3"	1613 mm	5'3.5"
Drum width	1000 mm	3'3.4"	1200 mm	3'11.2"	1422 mm	4'8"
Drum diameter	700 mm	2'3.5"	700 mm	2'3.5"	1100 mm	3'7.5"
Height w/ROPS	2500 mm	8'2"	1640 mm	5'4"	2970 mm	9'9"
Wheelbase	1700 mm	5'7"	1700 mm	5'6.9"	2616 mm	8'7"
Overall length	2430 mm	7'11.5"	2430 mm	7'11.5"	4191 mm	13'9"
Curb clearance	400 mm	15.75"	400 mm	15.75"	381 mm	15"
Ground clearance	250 mm	10"	250 mm	10"	381 mm	15"
Service Refill Capacities:						
Fuel tank	53 L	14 U.S. gal	53 L	14 U.S. gal	144 L	38 U.S. gal
Crankcase	4.5 L	1.19 U.S. gal	4.5 L	1.19 U.S. gal	7.6 L	2 U.S. gal
Hydraulic tank	29 L	7.7 U.S. gal	29 L	7.7 U.S. gal	57 L	15 U.S. gal
Sprinkler water	160 L	42 U.S. gal	160 L	42 U.S. gal	666 L	176 U.S. gal

*Not available in the United States.

Dual Drum Vibratory Asphalt Compactors

Specifications



MODEL	CB-544*		CB-534C*	
Flywheel Power	60 kW	80 hp	79 kW	106 hp
Rated Engine RPM	2200		2200	
No. Cylinders	4		4	
Displacement	4 L	243 in ³	4 L	243 in ³
Engine Model	3054		3054T	
Speeds:				
Forward	2		2	
Reverse	2		2	
Max. Speed (For./Rev.)	8.9 km/h	5.5 mph	11.3 km/h	0-7 mph
Operating Weight	10 700 kg	23,593 lb	9910 kg	21,850 lb
Shipping Weight	9777 kg	21,558 lb	8440 kg	18,610 lb
Drive	Hydraulic		Hydraulic	
Gradeability	35%		—	
Operator Position(s)	4		4	
Steering:				
Inside radius	3005 mm	9'10"	4165 mm	13'8"
Outside radius	4837 mm	15'10"	5865 mm	19'3"
Steering angle	±25°		±35°	
Vibratory System:				
Ecc. Weight Drive	Hydraulic		Hydraulic	
Frequency	42/50 Hz	2520/3000 vpm	42 Hz	2520 vpm
Amplitude Settings	1		3	
Centrifugal Force per drum (Max.)	86.8 kN	19,530 lb	118.1 kN	27,087 lb
General Dimensions:				
Overall width	1810 mm	5'11"	1850 mm	6'1"
Drum width	1700 mm	5'7"	1700 mm	5'7"
Drum diameter	1200 mm	3'11"	1300 mm	4'3"
Height w/ROPS	3000 mm	9'10"	3000 mm	9'10"
Wheelbase	3000 mm	9'10"	3150 mm	10'4"
Overall length	4200 mm	13'9"	4940 mm	16'2.5"
Curb clearance	855 mm	2'10"	416 mm	16"
Ground clearance	296 mm	12"	416 mm	16"
Service Refill Capacities:				
Fuel tank	208 L	55 U.S. gal	208 L	55 U.S. gal
Crankcase	9 L	2.4 U.S. gal	7.6 L	2 U.S. gal
Hydraulic tank	55 L	14.5 U.S. gal	54.9 L	14.5 U.S. gal
Sprinkler water	850 L	225 U.S. gal	1000 L	264 U.S. gal

*Not available in the United States.

ASPHALT COMPACTION PRODUCTION RATES

Formula for Compacted Cubic Yards (yd³) Per Hour:

$$\frac{W \times S \times L \times 16.3 \times .83}{P} = \text{yd}^3/\text{hr}$$

W = Effective width of compaction per pass in feet
(See NOTE below)

S = Average speed in MPH

L = Compacted Lift in Inches

16.3 = Constant

0.83 = Efficiency Rate (50 minute hour)

P = Number of passes required to achieve compaction

NOTE: In calculating the effective width of the compactor, the width of the laydown lane in relation to the roller width must be taken into consideration.

Example: A CB-634C with a 2130 mm (84 in) drum width takes two roller widths to cover a 3658 mm (12 ft) lane, therefore the effective rolling width is 1829 mm (6 ft). A CB-534C with a 1702 mm (67 in) drum width requires 3 passes to cover the 3658 mm (12 ft) lane, so effective rolling width is 1219 mm (4 ft). The CB-434C, with 1422 mm (56 in) drum width, requires three passes to cover the 3658 mm (12 ft) lane, so also has an effective rolling width of 1219 mm (4 ft) per pass.

Actual production rate will vary depending on many variables including the following:

- Asphalt mix
- Temperature of mix
- Ambient temperature
- Lift thickness
- Percent of density required
- Operator technique

**CB-224C
Capacity On Asphalt @ 3 MPH**

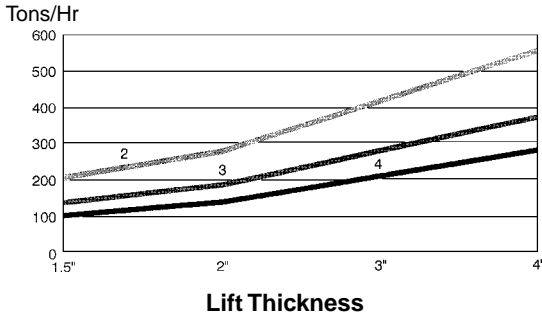

**CB-534B/CB-534C/CB-544
Capacity On Asphalt @ 3 MPH**

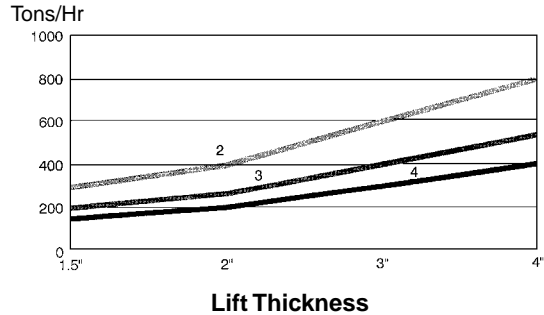

**CB-434B/CB-434C
Capacity On Asphalt @ 3 MPH**

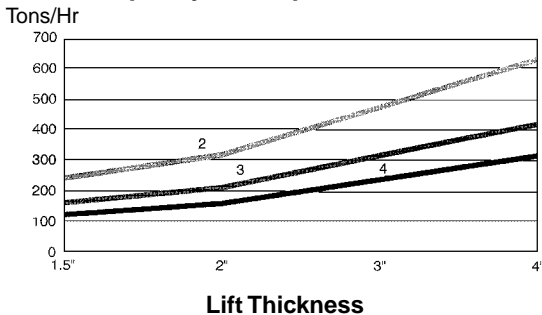

**CB-634C
Capacity On Asphalt @ 3 MPH**



KEY

- 2 — Two Passes
- 3 — Three Passes
- 4 — Four Passes

Combination Vibratory Asphalt Compactors

Features and Specifications

Features:

- **Direct hydrostatic drive** to front drum and rear tires, provides dependable, responsive propulsion effort and maximum gradeability.
- **Vibration stops when machine stops** to help produce a smooth flawless mat surface.
- **Maximum Visibility Multiple Position** sliding console for visibility to front and rear of machine as well as drum edges.
- **Large rust-proof water tanks** and pressure spray system provides hours of reliable operation between fill ups.
- **Equal spacing between tires.** The middle rear tire on the CB-535B is mounted on a hydraulic cylinder for equal weight per wheel and avoids bridging low spots.
- **ROPS Cab or ROPS Canopy** available as an option.
- **Operator comfort** is provided by adjustable bucket seat. Machine controls and instruments move with the operator to one of four operating positions allowing easy access.



MODEL	CB-535B**		CB-545**	
Flywheel Power	80 kW	107 hp	60 kW	80 hp
Rated Engine RPM	2200		2200	
No. Cylinders	4		4	
Displacement	4 L	243 in ³	4 L	243 in ³
Engine Model	3054 DIT		3054 DINA	
Speeds:				
Forward	3		2	
Reverse	3		2	
Max. Speed (For./Rev.)	12.7 km/h	7.9 mph	12.4 km/h	7.7 mph
Operating Weight	13 400 kg	29,547 lb	9410 kg	20,750 lb
Shipping Weight	13 035 kg	28,742 lb	8910 kg	19,645 lb
Drive	Hydraulic		Hydraulic	
Gradeability	±35°		±35°	
Position(s)	4		4	
Steering:				
Inside radius	4350 mm	14'3"	3005 mm	9'10"
Outside radius	6335 mm	20'9"	4837 mm	15'10"
Steering angle	±35°		±25°	
Vibratory System:				
Ecc. Weight Drive	Hydraulic		Hydraulic	
Frequency	42 Hz	2520 vpm	42/50 Hz	2520/3000 vpm
Amplitude Settings	0.36/0.80/1.05 mm		0.33/0.58 mm	
Centrifugal Force per drum/Drum (Max.)	118 kN	26,550 lb	80.54 kN	17,757 lb
Tires	15.00R*		13/80-20*	
Weight per wheel	3000 kg	6615 lb	1100 kg	3991 lb
General Dimensions:				
Overall width	1850 mm	6'1"	1810 mm	5'11"
Drum width	1700 mm	5'7"	1700 mm	5'7"
Drum diameter	1300 mm	4'3"	1200 mm	3'11"
Tire width			315 mm	
Overall height (w/ROPS)	3000 mm	9'10"	3000 mm	9'10"
Wheelbase	3516 mm	11'6"	3000 mm	9'10"
Overall length	5300 mm	17'5"	4200 mm	13'9"
Curb clearance	416 mm	16"	855 mm	2'10"
Service Refill Capacities:				
Fuel tank	208 L	55 U.S. gal	208 L	55 U.S. gal
Hydraulic fluid	55 L	14.5 U.S. gal	55 L	14.5 U.S. gal
Emulsion	130 L	34.3 U.S. gal	380 L	100 U.S. gal
Sprinkler water	440 L	116 U.S. gal	460 L	122 U.S. gal

*Optional treaded tires available.

**Not available in North America.



Features:

- **Designed for high density compaction** of any hot or cold mix or surface seal applications.
- **Tire positions overlap** to provide full width compaction in a single pass.
- **All wheel oscillation.** Front and rear seek out low spots and provide even wheel loads.
- **High drive propel system:** Completely hydrostatic with drive motors and brakes located in main-frame away from contamination and damage.
- **Hydraulic full-power steering** makes for effortless steering.
- **Ballast compartments** are easily accessible for quick loading and are located to provide a balanced wheel/weight ratio. Large side covers provide for fast, convenient unloading.

MODEL

PS-150B

Flywheel Power	60 kW	80 hp
Rated Engine RPM	2300	
No. Cylinders	4	
Displacement	3.9 L	243 in³
Engine Model	3054	
Speeds:		
Forward	2	
Reverse	2	
Max. Speed (For./Rev.)	25.6 km/h	15.9 mph
Wheel Configuration	5 front/6 rear	
Tires	7.5" × 15" 6 ply	
Operating Weight Empty (no ballast)	4885 kg	10,775 lb
Operating Weight Full (max. ballast)	12 940 kg	28,535 lb
Maximum Weight per Wheel	1438 kg	3173 lb
Steering:		
Inside radius	4846 mm	15'3"
Outside radius	6375 mm	20'11"
General Dimensions:		
Overall width	1750 mm	5'9"
Rolling width	1727 mm	5'8"
Overall height	3000 mm	9'10"
Wheelbase	3352 mm	11'0"
Overall length	4299 mm	14'1"
Ground clearance	267mm	10.5"
Service Refill Capacities:		
Fuel tank	173 L	45.7 U.S. gal
Crankcase	7.3 L	1.9 U.S. gal
Sprinkler water	394 L	104 U.S. gal



MODEL	PS-200B		PS-360B	
Flywheel Power	80 kW	107 hp	77.5 kW	104 hp
Rated Engine RPM	2200		2200	
No. Cylinders	4		4	
Displacement	3.9 L	243 in ³	3.9 L	243 in ³
Engine Model	3054T		3054T	
Speeds:				
Forward	2		2	
Reverse	2		2	
Max. Speed (For./Rev.)	19.3 km/h	12 mph	18 km/h	11.2 mph
Wheel Configuration	5 front/4 rear		3 front/4 rear	
Tires	7.5" × 15" 6 ply		14/70 × 20	
Operating Weight Empty (no ballast)	4133 kg	9110 lb	8500 kg	18,740 lb
Operating Weight Full (max. ballast)	18 145 kg	40,000 lb	25 000 kg	55,115 lb
Maximum Weight per Wheel	2016 kg	4444 lb	3570 kg	7870 lb
Steering:				
Inside radius	4648 mm	15'3"	3470 mm	11'5"
Outside radius	6375 mm	20'11"	6700 mm	22'0"
General Dimensions:				
Overall width	1750 mm	5'9"	2150 mm	7'1"
Rolling width	1727 mm	5'8"	2275 mm	7'6"
Overall height	3000 mm	9'10"	2530 mm	8'4"
Wheelbase	3352 mm	11'0"	3650 mm	12'0"
Overall length	4299 mm	14'1"	4850 mm	15'11"
Ground Clearance	267 mm	10.5"	252 mm	10"
Service Refill Capacities:				
Fuel tank	173 L	45.7 U.S. gal	200 L	53 U.S. gal
Crankcase	7.3 L	1.9 U.S. gal	7.3 L	1.9 U.S. gal
Sprinkler water	394 L	104 U.S. gal	394 L	104 U.S. gal

LIFT THICKNESS

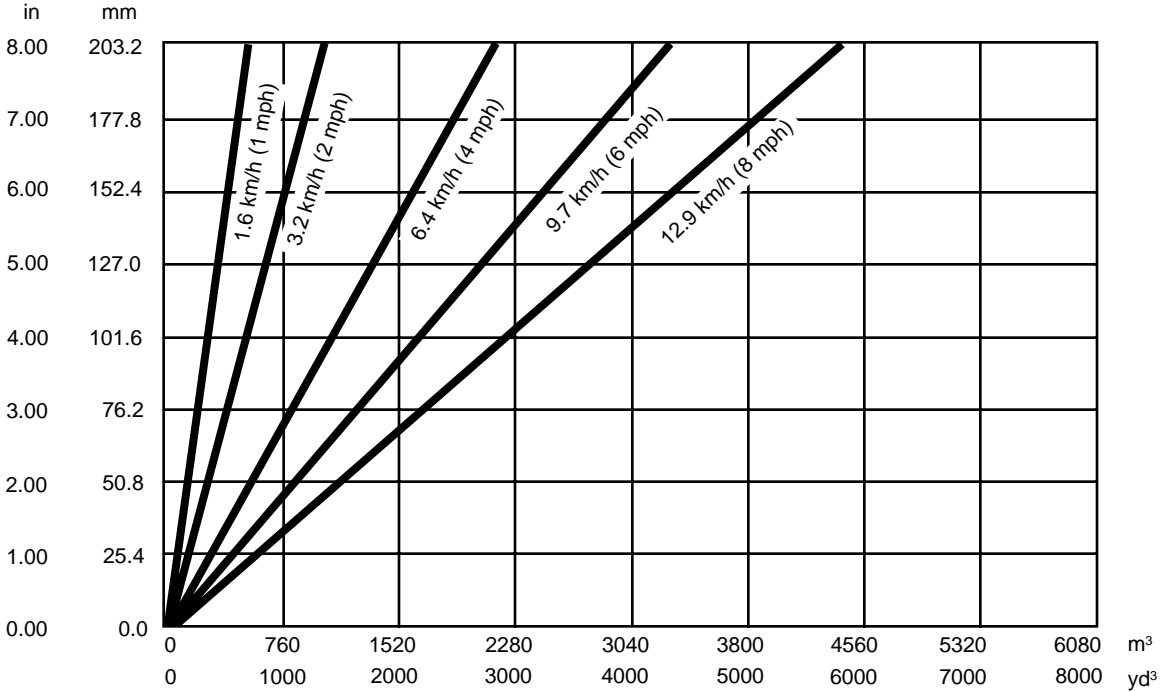

m³ (yd³) per hour per pass

$$\text{Production Rate [m³ (yd³)]} = \frac{\text{m³ (yd³)/hr per pass}}{\text{No. of passes required}}$$



Features:

- **Designed for high density compaction of any hot or cold mix or surface seal applications.**
- **Tire positions overlap** to provide full width compaction in a single pass.
- **Wheel suspension** helps eliminate bridging of low spots and helps provide equal load under each wheel. PS models have suspension front and rear. PF models have rear suspension only.
- **Single-lever fingertips control of forward and reverse movement** makes smooth shuttle rolling easy.
- **Heavy-duty 3-speed powershift transmission** allows infinitely variable travel speeds up to 26.5 km/h (16.5 mph), forward or reverse.
- **Hydraulic full-power steering** makes for effortless steering. Steer wheels swivel individually preventing scuffing of material during turns, similar to automotive style steering.
- **Ballast compartments are easily accessible for quick loading and are located** to provide a balanced wheel/weight ratio.
- **Electric pump water spray system with cleaner mats on all wheels** keep tires clean and resistant to pick-up during compaction.
- **Optional on-the-run tire inflation device**, engine cooled for long life.

MODEL

PF-300B/PS-300B

Flywheel Power	80 kW	107 hp
Rated Engine RPM	2200	
No. Cylinders		
Displacement	4 L	243 in ³
Engine Model	3054 DIT	
Speeds:		
Forward		3
Reverse		3
Max. Speed	20 km/h	12.4 mph
Wheel Configuration	3 front/4 rear	
Tires	13/80-20*	
Operating Weight Empty (no ballast)	14 000 kg	30,870 lb
Operating Weight Full (max. ballast)**	23 300 kg	51,380 lb
Maximum Weight per Wheel**	3300 kg	7280 lb
Shipping weight	14 000 kg	30,870 lb
Drive	Mechanical	
Gradeability	±45°	
Operator positions	4	
Steering:		
Inside radius	4800 mm	15'9"
Outside radius	7700 mm	25'3"
General Dimensions:		
Overall width	2000 mm	6'7"
Rolling width	1900 mm	6'3"
Tire width	315 mm	12"
Tire overlap	48 mm	1.9"
Overall height w/ROPS	3000 mm	9'10"
Wheelbase	4030 mm	13'3"
Overall length	5300 mm	17'5"
Ground clearance	250 mm	9.8"
Service Refill Capacities:		
Fuel tank	215 L	56.8 U.S. gal
Crankcase	7 L	1.8 U.S. gal
Cooling system	28 L	7.4 U.S. gal
Differential	7 L	1.8 U.S. gal
Transmission	22 L	5.8 U.S. gal
Hydraulic fluid	10 L	2.6 U.S. gal
Sprinkler water	460 L	121 U.S. gal

*Optional treaded tires available.

**Includes added weight option.



MODEL	PS-500*	
Flywheel Power	112 kW	150 hp
Rated Engine RPM	2300	
No. Cylinders	8	
Displacement	10.4 L	636 in ³
Engine Model	3208	
Speeds:		
Forward	3	
Reverse	3	
Max. Speed	26.5 km/h	16.5 mph
Wheel Configuration	3 front/4 rear	
Tires	15.00 R 24	
Operating Weight Empty (no ballast)	19 000 kg	41,875 lb
Operating Weight Full (max. ballast)	35 000 kg	77,140 lb
Maximum Weight per Wheel	5000 kg	11,020 lb
Steering:		
Inside radius	5150 mm	16'11"
Outside radius	8550 mm	28'1"
General Dimensions:		
Overall width	2500 mm	8'2"
Rolling width	2420 mm	7'11"
Overall height w/ROPS	3630 mm	11'11"
Wheelbase	4465 mm	14'8"
Overall length	6270 mm	20'7"
Ground clearance	360 mm	14.2"
Service Refill Capacities:		
Fuel tank	310 L	82 U.S. gal
Crankcase	12.5 L	3.3 U.S. gal
Sprinkler water	350 L	92 U.S. gal

*Not available in the United States.

The following table gives, as a guide, the utilization possibilities of the equipment on different types of materials. The symbols and values given correspond to the following cases: ● equipment well suited to this utilization — current utilization: 0.30/0.80 the top figure indicates the minimum rational thickness in metres; the bottom figure indicates the thickness capable of yielding a maximum output — ▲ possible but not current utilization.

Roadworks

Surface dressing	●
wearing course (bituminous mixes)	≥ 0.03
base course	0.10 0.30
sub-base	0.10 0.40
sub-grade	●

Earthworks: coarse grained soils

rock D > 250 mm	
shot rock D ≤ 250 mm	
well graded gravel GW	0.10 0.30
poorly grade gravel GP	▲
silty gravel GF	0.10 0.40
clayey gravel GC	0.15 0.30
well graded sand SW	0.10 0.40
poorly graded sand SP	▲
silty sand SF	0.10 0.40
clayey sand SC	0.10 0.30

Earthworks: fine grained soils

low plasticity silt ML	▲
low plasticity clay CL	▲
high plasticity silt MH	
high plasticity clay CH	
lime stabilized fine soils	0.15 0.30
limestone	0.10 0.30

Nomograms of Ground Pressure

These nomograms make it possible to determine the pressure exerted on the ground under a wheel as a function of its load and of the tire inflation pressure.

Ground pressure values are theoretical because they result from prints obtained on an indeformable ground.

**treadless tires
 E 20 Pilote X (13/80-20) Michelin**

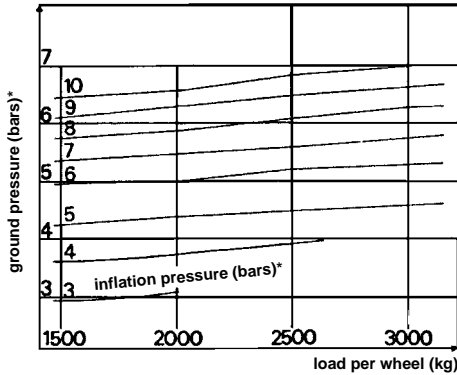

**treaded tires
 F 20 Pilote XZZ (14/80-20) Michelin**

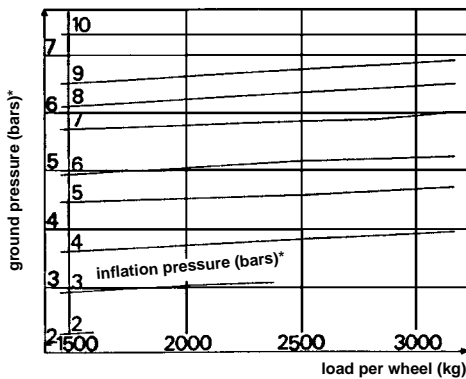

*1 bar = 1.02 kg/cm²

Nomogram of hourly output

The gross hourly output of the equipment is given by the formula: $Q (m^3/h) = V.H.L/N$ where V is the working speed in metres/hour; H is the thickness of the compacted layer in metres; L is the compacted width in metres; N is the number of passes.

The facing nomogram makes it possible to determine the gross hourly output of the equipment without calculation: on the basis of the chosen working speed, draw a vertical line; where it intersects with the "layer thickness" line selected, draw a horizontal line; where this horizontal intersects with the "number of passes" line adopted, draw a vertical line which gives directly the value of the gross hourly output in m³/h.

The net output is obtained by multiplying the gross value by a coefficient depending on jobsite conditions: — easy: 0.8 — normal: 0.7 — difficult: 0.6

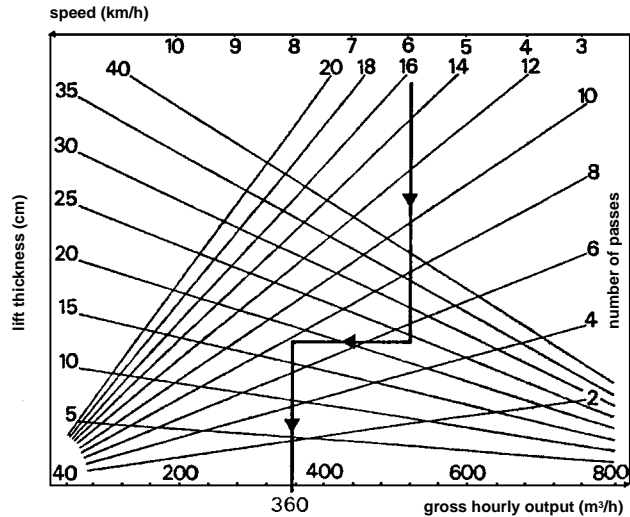

The following table gives, as a guide, the utilization possibilities of the equipment on different types of materials. The symbols and values given correspond to the following cases: ● equipment well suited to this utilization — current utilization: 0.30/0.80 the top figure indicates the minimum rational thickness in metres; the bottom figure indicates the thickness capable of yielding a maximum output — ▲ possible but not current utilization.

Roadworks

Surface dressing	▲
wearing course (bituminous mixes)	≥ 0.05
base course	0.15 0.40
sub-base	0.15 0.40
sub-grade	●

Earthworks: coarse grained soils

rock D > 250 mm	
shot rock D ≤ 250 mm	▲
well graded gravel GW	0.15 0.60
poorly graded gravel GP	0.20 0.50
silty gravel GF	0.15 0.60
clayey gravel GC	0.20 0.50
well graded sand SW	0.15 0.60
poorly graded sand SP	0.20 0.50
silty sand SF	0.15 0.60
clayey sand SC	0.15 0.50

Earthworks: fine grained soils

low plasticity silt ML	0.20 0.70
low plasticity clay CL	0.20 0.50
high plasticity silt MH	0.15 0.30
high plasticity clay CH	0.15 0.30
lime stabilized fine soils	0.20 0.40
limestone	0.15 0.40

Nomograms of Ground Pressure

These nomograms make it possible to determine the pressure exerted on the ground under a wheel as a function of its load and of the tire inflation pressure.

Ground pressure values are theoretical because they result from prints obtained on an indeformable ground.

treadless tires
15.00-24 X (17/80-24) Michelin

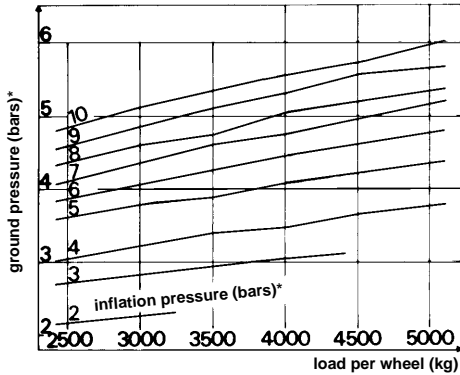

treaded tires
16.00-20 XS Michelin

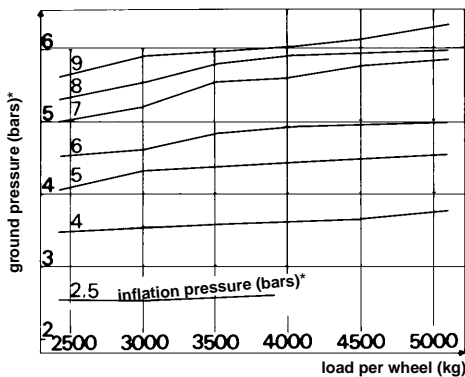

*1 bar = 1.02 kg/cm²

Nomogram of hourly output

The gross hourly output of the equipment is given by the formula: $Q (m^3/h) = V.H.L/N$ where V is the working speed in metres/hour; H is the thickness of the compacted layer in metres; L is the compacted width in metres; N is the number of passes.

The facing nomogram makes it possible to determine the gross hourly output of the equipment without calculation: on the basis of the chosen working speed, draw a vertical line; where it intersects with the "layer thickness" line selected, draw a horizontal line; where this horizontal intersects with the "number of passes" line adopted, draw a vertical line which gives directly the value of the gross hourly output in m³/h.

The net output is obtained by multiplying the gross value by a coefficient depending on jobsite conditions: — easy: 0.8 — normal: 0.7 — difficult: 0.6

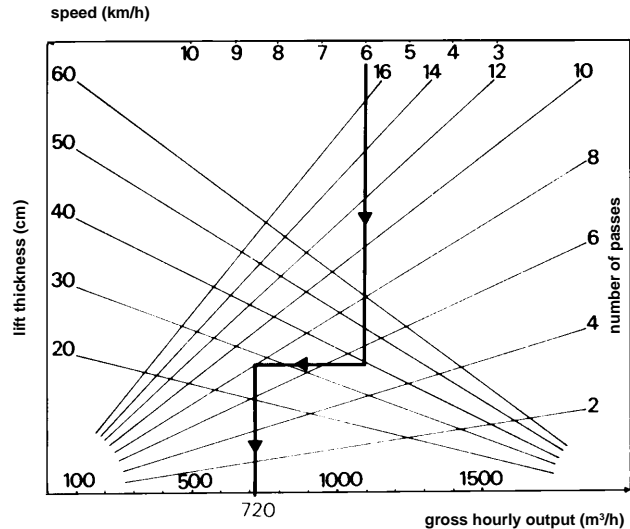

ELPHINSTONE UNDERGROUND MACHINES

Loaders and Haulers for Hard Rock Mining

CONTENTS

Features	17-1
Load-Haul-Dumps (LHDs):	
Specifications	17-2
Dimensions and capacities	17-4
Bucket selection	17-5
Turning dimensions	17-5
Trucks:	
Articulated specifications	17-6
Rigid frame specifications	17-7
Dimensions and capacities	17-8
LHD and Truck Systems	17-9

Elphinstone machines:

- Produced by a joint venture company of Caterpillar Inc. and Dale B. Elphinstone Pty Ltd.
- Manufactured in Burnie, Tasmania (Australia).
- Supported by the worldwide Caterpillar parts and dealer network.

Features, all models:

- Rugged design for underground application.
- Caterpillar diesel engines and power trains.
- High proportion of Caterpillar parts.
- Extensive use of steel castings and forgings.
- Engineered for productivity, reliability, safety, and machine rebuildability.
- Remote control options on loaders.

Elphinstone product line:

- Four models of Load-Haul-Dump (LHD) machines, with rated bucket payloads ranging from 6.5-17 tonnes (17 to 19 tons).
- Dump and ejector versions of an articulated truck, with payload capacities of 40-44 tonnes (44-48 tons).
- Three models of rigid frame trucks; dump versions with 38 tonne (42 tons) and 52 tonne (58 tons) payload capacity; ejector version with 36 tonne (40 tons) capacity.



MODEL	R1300		R1600	
Bucket Size Minimum	2.4 m ³	3 yd³	4.2 m ³	5 yd³
Bucket Size Maximum	3.4 m ³	4 yd³	5.9 m ³	8 yd³
Tramming Capacity	6500 kg	14,330 lb	10 200 kg	22,490 lb
Length	8650 mm	28'5"	9710 mm	31'10"
Width Bucket	2000 mm	6'7"	2600 mm	8'6"
Width over Tires	1900 mm	6'3"	2400 mm	7'10"
Height	2000 mm	6'7"	2400 mm	7'10"
Operating Weight	19 000 kg	41,900 lb	29 800 kg	65,710 lb
Engine Power	123 kw	165 hp	201 kW	270 hp
Engine Model	Cat 3306 DITA		Cat 3176C ATAAC	
Tire Size	17.5x25 20 Ply L5 STMS		18x25 28 Ply STMS	
Outer Turning Radius	5575 mm	18'3"	6540 mm	21'5"
Inner Turning Radius	2972 mm	9'9"	3305 mm	10'10"
Articulation Angle	42.5°		42.5°	
Oscillation Angle	±10°		±10°	
Bucket Raise Time	5		7.6	
Bucket Lower Time	2.3		1.6	
Bucket Tip Time	2		2	
Bucket Total Time	9.3		11.2	
Travel Speeds	km/h	mph	km/h	mph
Forward 1	4.2	2.6	5.5	3.4
2	7.6	4.7	9.8	6.1
3	13.8	8.6	17.5	10.9
4	24.1	15	30.6	19
Reverse 1	3.7	2.3	6.2	3.9
2	6.8	4.2	11.2	7
3	12.4	7.7	19.8	12.3
4	21.7	13.5	34	21.1
Maximum Bucket Pin Height	2900 mm	9'6"	3752 mm	12'4"
Maximum Bucket Dump Angle	43°		45°	
Break Out Force Tilt SAE	12 020 kg	26,500 lb	19 500 kg	43,000 lb
Static Tipping (Tramming)	22 615 kg	49,870 lb	33 350 kg	73,540 lb
Emergency Brake	S.A.F.R. Inboard Spring Applied Fluid Released, Enclosed Wet Disc @ All Wheels, Front and Rear Circuits		S.A.F.R. Inboard Spring Applied Fluid Released, Enclosed Wet Disc @ All Wheels, Front and Rear Circuits	
Service Brake	Hydraulically Applied Spring Released, Enclosed Wet Disc @ All Wheels, Front and Rear Circuits		Fluid Applied Spring Released, Wet Disc	
Park Brake	S.A.F.R. Inboard Spring Applied Fluid Released, Enclosed Wet Disc @ All Wheels, Front and Rear Circuits		S.A.F.R. Inboard Spring Applied Fluid Released, Enclosed Wet Disc @ All Wheels, Front and Rear Circuits	
Fuel Capacity	260 L	69 U.S. gal	400 L	106 U.S. gal



MODEL	R1700 Series II		R2900	
Bucket Size Minimum	4.6 m ³	6 yd ³	6.4 m ³	8 yd ³
Bucket Size Maximum	6.7 m ³	9 yd ³	11.5 m ³	15 yd ³
Tramming Capacity	12 000 kg	26,460 lb	17 200 kg	37,930 lb
Length	10 417 mm	34'2"	10 970 mm	36'0"
Width Bucket	2818 mm	9'3"	3100 mm	10'2"
Width over Tires	2550 mm	8'4"	2900 mm	9'6"
Height	2630 mm	8'8"	2888 mm	9'6"
Operating Weight	36 000 kg	79,380 lb	46 500 kg	102,530 lb
Engine Power	231 kW	310 hp	269 kW	361 hp
Engine Model	Cat 3176B ATAAC		Cat 3406E ATAAC	
Tire Size	26.5x25 32 Ply L5 STMS		29.5x29 34 Ply STMS	
Outer Turning Radius	6755 mm	22'2"	7310 mm	24'0"
Inner Turning Radius	3165 mm	10'5"	3410 mm	11'2"
Articulation Angle	45°		42.5°	
Oscillation Angle	±8°		±8°	
Bucket Raise Time	6.7		6.7	
Bucket Lower Time	2.4		2.4	
Bucket Tip Time	2.8		2.8	
Bucket Total Time	11.9		11.9	
Travel Speeds	km/h	mph	km/h	mph
Forward 1	5.1	3.2	5.1	3.2
2	9	5.6	9.2	5.7
3	18.6	11.6	15.7	9.8
4	26.8	16.6	26.7	16.6
Reverse 1	5.8	3.6	6.4	4
2	10.3	6.4	11.2	7
3	17.9	11.1	19.3	12
4	30.6	19	32.5	20.2
Maximum Bucket Pin Height	4098 mm	13'5"	4540 mm	14'11"
Maximum Bucket Dump Angle	46°		46°	
Break Out Force Tilt SAE	23 430 kg	51,660 lb	28 600 kg	63,060 lb
Static Tipping (Tramming)	31 900 kg	70,340 lb	39 690 kg	87,520 lb
Emergency Brake	Combined Driveline and Service Brakes		Spring Applied Fluid Released, Wet Discs All Wheel Ends	
Service Brake	Fluid Applied Spring Released, Wet Disc All Wheels		Fluid Applied Wet Discs All Wheel Ends	
Park Brake	Spring Applied Hydraulic Released on Driveline		Spring Applied Fluid Released, Wet Discs All Wheel Ends	
Fuel Capacity	520 L	137 U.S. gal	900 L	238 U.S. gal
Load Clearance	—	—	2955 mm	9'8"

Model	R1300		R1600		R1700 Series II		R2900	
Rated payload	6500 kg	14,330 lb	10 200 kg	22,490 lb	12 000 kg	26,460 lb	17 200 kg	37,930 lb
Bucket capacity	3.4 m ³	4.4 yd³	5.9 m ³	7.7 yd³	6.7 m ³	8.8 yd³	11.5 m ³	15 yd³
Overall width	2000 mm	6'7"	2600 mm	8'6"	2818 mm	9'3"	3100 mm	10'2"
Overall height	2000 mm	6'7"	2400 mm	7'10"	2630 mm	8'8"	2888 mm	8'6"
Length (tramming)	8650 mm	28'5"	9710 mm	31'10"	10 417 mm	34'2"	10 970 mm	36'0"
Empty weight	19 000 kg	41,900 lb	29 800 kg	65,710 lb	36 000 kg	79,380 lb	46 500 kg	102,530 lb
Loaded weight	25 500 kg	56,230 lb	40 000 kg	88,200 lb	48 000 kg	105,840 lb	63 700 kg	140,460 lb
Ground clearance	320 mm	12.6"	342 mm	13.5"	400 mm	15.7"	500 mm	19.7"
Axle oscillation	±10°		±10°		±8°		±8°	

Model	Bucket Type	SAE Capacity	
		m³	yd³
R1300	Standard	2.4	3.1
	Standard	2.8	3.7
	Standard	3.4	4.4
	High penetration	2.4	3.1
	High penetration	2.8	3.7
	High penetration	3.4	4.4
	Ejector	2.5	3.3
R1600	Standard	4.2	5.5
	Standard	4.8	6.3
	Standard	5.9	7.7
	High penetration	4.2	5.5
	High penetration	4.8	6.3
	High penetration	5.9	7.7
	Ejector	4.5	5.9
R1700 Series II	Standard	4.6	6.0
	Standard	5.0	6.5
	Standard	5.8	7.6
	Standard	6.7	8.8
	High penetration	5.0	6.5
	High penetration	5.8	7.6
	High penetration	6.7	8.8
R2900	Standard	6.4	8.4
	Standard	7.3	9.5
	Standard	8.8	11.5
	Standard	11.5	15.0
	High penetration	6.4	8.4
	High penetration	7.3	9.5
	High penetration	8.8	11.5
	High penetration	11.5	15.0

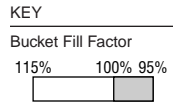
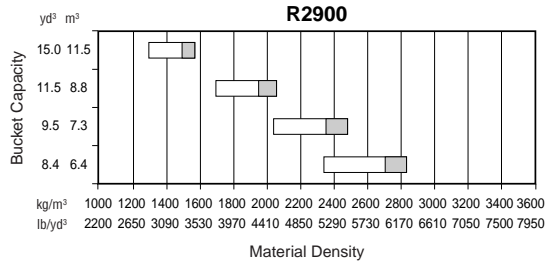
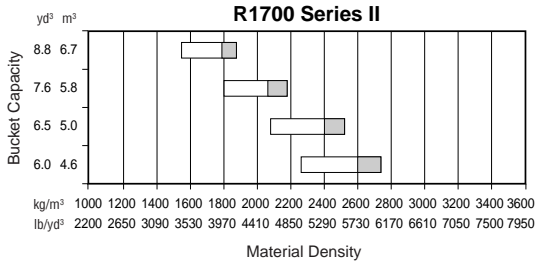
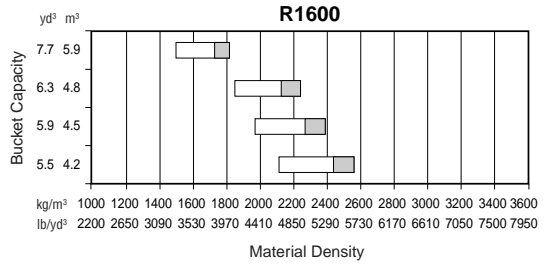
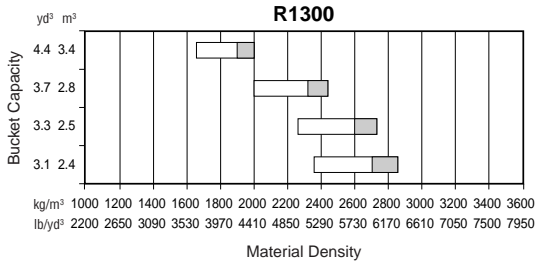

Turning Dimensions

Model	R1300		R1600		R1700 Series II		R2900	
Turn radius (outside)	5575 mm	18'4"	6540 mm	21'5"	6755 mm	22'2"	7310 mm	24'0"
Turn radius (inside)	2972 mm	9'9"	3305 mm	10'10"	3165 mm	10'5"	3410 mm	11'2"
Articulation angle	±42.5°		±42.5°		±45°		±42.5°	



MODEL	AD40 Series II		AE40 Series II	
Engine Power	365 kW	489 hp	365 kW	489 hp
Engine Model	3408E HEUI		3408E HEUI	
Tare Weight	38 100 kg	84,000 lbs	41 800 kg	92,170 lbs
Max. Capacity Tonnes	44 t	48 T	40 t	44 T
Capacity M3 (SAE) 2:1 Heaped	18.4 m ³	24 yd³	18.4 m ³	24 yd³
Distribution Loaded Front		48%		47%
Distribution Loaded Rear		52%		53%
Turning Radius	9228 mm	30'3"	9589 mm	31'6"
Height	2700 mm	8'10"	2890 mm	9'6"
Length	10 660 mm	35'0"	11 266 mm	37'0"
Loading Height	2660 mm	8'9"	2700 mm	8'10"
Width	3000 mm	9'10"	3200 mm	10'5"
Oscillation		12°		12°
Articulation		42.5°		42.5°
Tray Height Raised	5946 mm	19'6"		N/A
Dump Time Sec		10		15
Travel Speeds	km/h	mph	km/h	mph
Forward 1	7.7	4.8	7.7	4.8
2	10.6	6.6	10.6	6.6
3	14.5	9	14.5	9
4	19.3	12	19.3	12
5	26.2	16.3	26.2	16.3
6	35.4	22	35.4	22
7	48.1	29.9	48.1	29.9
8	—	—	—	—
Reverse 1	7.7	4.8	7.7	4.8
2	10.6	6.6	10.6	6.6
Tire Size	29.5x29 2** Radials		29.5x29 2** Radials	
Emergency Brake	Spring Applied Hyd. Released All Wheels		Spring Applied Hyd. Released All Wheels	
Service Brake	Caterpillar Oil Cooled Hyd. Applied Wet Disc All Wheels		Caterpillar Oil Cooled Hyd. Applied Wet Disc All Wheels	
Park Brake	Spring Applied Hyd. Released All Wheels		Spring Applied Hyd. Released All Wheels	
Fuel Capacity	520 L	137 U.S. gal	520 L	137 U.S. gal



MODEL	69D Dump		69D Ejector		73D	
Engine Power	380 kW	510 hp	380 kW	510 hp	509 kW	683 hp
Engine Model	3408E HEUI		3408E HEUI		3412E HEUI	
Tare Weight	30 100 kg	66,370 lbs	34 700 kg	78,500 lbs	40 300 kg	88,860 lbs
Max. Capacity Tonnes	38 t	42 T	36.2 t	40 T	52.2 t	58 T
Capacity M3 (SAE) 2:1 Heaped	18.3 m ³	24 yd ³	18.2 m ³	24 yd ³	31.9 m ³	42 yd ³
Distribution Loaded Front	33%		31%		33%	
Distribution Loaded Rear	67%		69%		67%	
Turning Radius	9616 mm	31'7"	9616 mm	31'7"	10 820 mm	35'6"
Height	3442 mm	11'4"	3442 mm	11'4"	3770 mm	12'4"
Length	8127 mm	26'8"	7830 mm	25'8"	9230 mm	30'3"
Loading Height	3058 mm	10'0"	3160 mm	10'4"	3400 mm	11'2"
Width	3665 mm	12'0"	3665 mm	12'0"	4200 mm	13'9"
Oscillation	N/A		N/A		N/A	
Articulation	N/A		N/A		N/A	
Tray Height Raised	5735 mm	18'10"	N/A	N/A	6635 mm	21'9"
Dump Time Sec	9		16		11.4	
Travel Speeds	km/h	mph	km/h	mph	km/h	mph
Forward 1	12.4	7.7	12.4	7.7	9.2	5.7
2	16.9	10.5	16.9	10.5	12.7	7.9
3	23	14.3	23	14.3	17.2	10.7
4	30.9	19.2	30.9	19.2	23.2	14.4
5	41.2	25.6	41.2	25.6	31.4	19.5
6	54.2	33.7	54.2	33.7	42.3	26.3
7	76.6	47.6	76.6	47.6	57.3	35.6
8	—	—	—	—	—	—
Reverse 1	13.5	8.4	13.5	8.4	11.3	7
2	N/A		N/A		N/A	
Tire Size	18x33 2** Radials		18x33 2** Radials		21x35 2** Radials	
Emergency Brake	Caterpillar Oil Cooled Hyd. Applied Wet Discs on Rear Dry Disc on Front		Caterpillar Oil Cooled Hyd. Applied Wet Discs on Rear Dry Disc on Front		Caterpillar Oil Cooled Hyd. Applied Wet Discs on Rear Dry Disc on Front	
Service Brake	Caterpillar Oil Cooled Hyd. Applied Wet Disc on Rear Dry Disc on Front		Caterpillar Oil Cooled Hyd. Applied Wet Disc on Rear Dry Disc on Front		Caterpillar Oil Cooled Hyd. Applied Wet Disc on Rear Dry Disc on Front	
Park Brake	Spring Applied Hyd. Released All Wheels		Spring Applied Hyd. Released All Wheels		Spring Applied Hyd. Released All Wheels	
Fuel Capacity	530 L	140 U.S. gal	530 L	140 U.S. gal	700 L	185 U.S. gal

Articulated Trucks

Model	AD40 Series II		AE40 Series II	
Heaped capacity*	18.4 m ³	24.1 yd³	18.4 m ³	24.1 yd³
Overall width	3000 mm	9'10"	3200 mm	10'6"
Overall height	2700 mm	8'10"	2890 mm	9'6"
Overall length	10 660 mm	35'0"	11 265 mm	36'11"
Empty weight	38 100 kg	84,010 lb	41 800 kg	92,170 lb
Loaded weight	78 100 kg	172,210 lb	81 800 kg	180,370 lb
Ground clearance	452 mm	17.8"	452 mm	17.8"
Frame oscillation	±12°		±12°	

*2:1 per SAE.

Rigid Frame Trucks

Model	69D Dump		69D Ejector		73D	
Max. capacity	38 t	41.9 T	36.2 t	39.9 T	52.2 t	57.5 T
Heaped capacity	18.3 m ³	23.9 yd³	18.2 m ³	23.8 yd³	31.9 m ³	41.7 yd³
Height (FOPS)	3442 mm	11'4"	3442 mm	11'4"	3770 mm	12'4"
Length	8127 mm	26'8"	7830 mm	25'8"	9230 mm	30'3"
Width	3665 mm	12'0"	3665 mm	12'0"	4200 mm	13'9"
Loading height (empty)	3058 mm	10'0"	3160 mm	10'4"	3400 mm	11'2"

Body Selection

Model	SAE Body Capacity	
AD40 Series II	18.4 m ³	24.1 yd³
	21.3 m ³	27.9 yd³
	25.5 m ³	33.4 yd³
AE40 Series II	18.4 m ³	24.1 yd³
	17.7 m ³	23.2 yd³
	20.8 m ³	27.2 yd³
69D Dump	18.3 m ³	23.9 yd³
	22.7 m ³	29.7 yd³
	24.9 m ³	32.6 yd³
69D Ejector	18.2 m ³	23.8 yd³
73D	31.9 m ³	41.7 yd³
	24.0 m ³	31.4 yd³
	30.6 m ³	40.0 yd³

Turning Dimensions

Articulated Trucks

Model	AD40 Series II		AE40 Series II	
Turn radius (outside)	9228 mm	30'3"	9589 mm	31'6"
Turn radius (inside)	5296 mm	17'5"	5448 mm	19'11"
Articulation angle	±42.5°		±42.5°	

Rigid Frame Trucks

Model	69D Dump		69D Ejector		73D	
Turn circle (outside)	9616 mm	31'7"	9616 mm	31'7"	10 820 mm	35'6"
Turn circle (inside)	4372 mm	14'4"	4372 mm	14'4"	5090 mm	16'8"

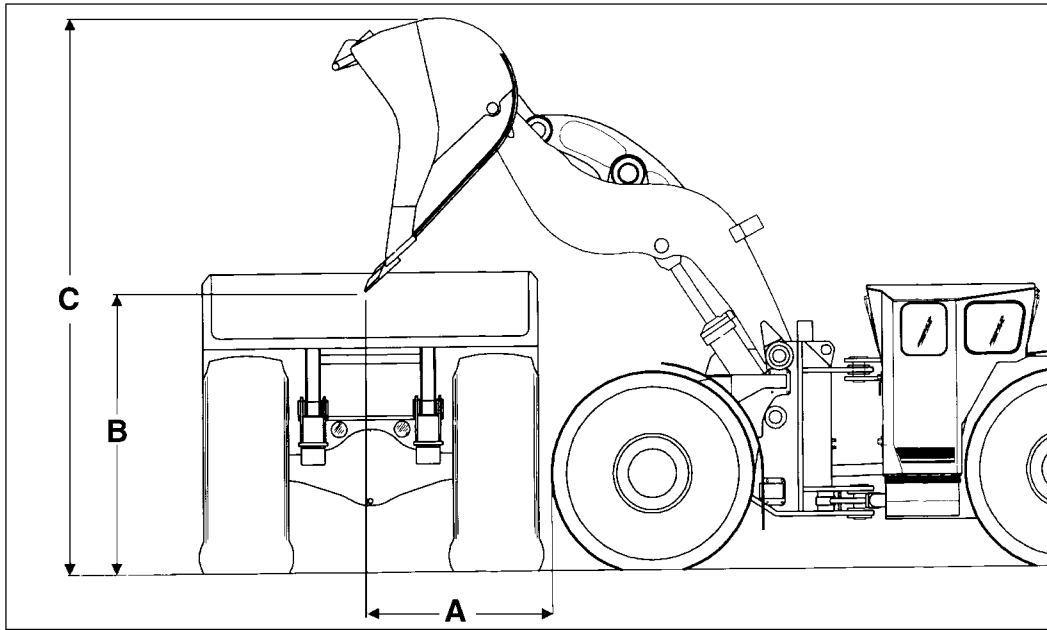

Loader	Target	A		B		C	
R1300		1637 mm	5'4.5"	1632 mm	5'4"	3525 mm	11'7"
R1600	AD40 Series II	1408 mm	4'7"	2213 mm	7'3"	4497 mm	14'9"
R1700 Series II	AD40 Series II	1652 mm	5'5"	2490 mm	8'2"	4903 mm	16'1"
R2900	AD40 Series II	1625 mm	5'4"	2855 mm	9'4"	5370 mm	17'7"
R2900	69D	1625 mm	5'4"	2855 mm	9'4"	5370 mm	17'7"
R2900	73D	1625 mm	5'4"	2855 mm	9'4"	5370 mm	17'7"

HYDROMECHANICAL WORK TOOLS

CONTENTS

HYDRAULIC HAMMERS

Features:

H115s-H195	18-1
H45-H100	18-2
Applications	18-3
Specifications	18-4
Selection guide	18-7
Productivity tables	18-8

MOBILE SHEARS

Features	18-10
Applications	18-10
Shearing capabilities table	18-10
Specifications	18-11
Matching guide	18-12

CONCRETE PULVERIZERS

Features	18-13
Applications	18-13
Matching guide	18-13
Specifications	18-14

CONCRETE CRUSHERS

Features	18-15
Applications	18-15
Matching guide	18-15
Specifications	18-16

HYDRAULIC HAMMERS

H115s-H195 Hammer Features:

- **Shock Mount** isolates both short and long duration forces to protect the carrier.
- **Integrally Mounted Accumulator** dampens pressure peaks inside the hammer to further protect the carrier hydraulic system, and assist the piston in the power stroke.
- **Pressure Control Valve** allows hammer to always strike with maximum fixed energy per blow.
- **Main Valve** directs the firing cycle and blocks the return port to protect the carrier hydraulics from pressure peaks.
- **Check Valve** protects the carrier hydraulics from pressure spikes.
- **Tie Rods** are heat torqued to ensure maximum clamping force and minimal maintenance.
- **Long Heavy Piston** minimizes recoil forces to protect hammer components and carrier structures.
- **Slip Fit Thrust Ring** is rotatable for longer life and is replaceable. Dissipates shock loads in abusive applications.
- **High Abrasion Resilient Plastic Wear Plates** on all four sides guide the power cell within the housing.
- **Slip Fit Upper Tool Bushing** is rotatable for longer life and is replaceable. Guides the tool to optimize in-line piston/tool contact.
- **Slip Fit Lower Tool Bushing** is field replaceable and rotatable. It has grease retention grooves for extended lubrication and wear indication.
- **Sound Suppression** consists of housing noise abatement material, plugs and covers.
- **Autolube** available for all hammers.

H45-H100 Hammer Features:

- **Low Pressure Accumulator** assists in the power stroke of the piston.
- **Custom Side Plates** designed for Caterpillar carrier geometry. Protects power cell and front end.
- **High Pressure Accumulator** protects against internal cavitation. Dampens pressure peaks thus protecting carrier hydraulic system.
- **Distributor** has high oil volume for ultra high blow frequency.
- **Pressure Adjusting Valve** assures that all blows are delivered at a constant blow energy.
- **Long Heavy Piston** delivers maximum impact energy and minimizes recoil forces to carrier.
- **Long Front End** ensures proper piston — tool alignment.
- **Slip Fit Thrust Ring** is rotatable for additional life and dissipates harmful shock loads in abusive applications.
- **Slip Fit Upper Tool Bushing** is rotatable for additional life and provides positive alignment of the tool.
- **Slip Fit Lower Tool Bushing** is field replaceable. Grease retention grooves provide extended lubrications and wear indication.
- **Autolube** available on all models.
- **Sound suppressed** versions available for all models.

Hammer Applications

- Sewer and Water — The hammer can be used on pockets of rock that slow down production. Also good for breaking up old concrete pipes, manholes, etc.
- Road Construction — An essential tool during improvements and upgrading. The hammer works well on removing existing curbs, traffic islands, ramps, or sections of concrete. With special tools, it can cut asphalt.
- Bridge Renewal — Hammers are increasingly used to remove old bridge surfaces, railing supports, abutments, retaining walls, etc.
- Demolition — The hammer-equipped excavator is often a key helper in industrial demolition. It can break up fallen wall sections and floor sections as well as handling loading ramps, foundations, or other brick and concrete structures near ground level.
- Mining — Hammers can break oversized material to avoid secondary blasting, and size riprap.
- Trenching/Primary Excavation — In soft or layered materials, the hydraulic hammer with amoil or chisel point can be cost-effective.
- Tunneling — This work has traditionally been performed by tunnel boring machines or the drill-and blast method. As hydraulic hammers have improved in power and reliability, they have been proven an economical alternative.
- Direct Quarrying — In many types of limestone, direct quarrying with hydraulic hammers can prove cost effective, especially where blasting is prohibited. See Hydraulic Hammer productivity graphs for production estimates.

A hammer need not be full time attachment for these applications. It can be replaced by a bucket in very little time so the excavator can be used for digging, loading, lifting, or other tasks.

Consult your Caterpillar dealer for advice on correct sizing, installation and tool selection.

NOTES: Internal components of hammers are finely machined to close tolerances and require clean oil with full lubricating properties. Hammers also tend to heat hydraulic oil considerably and this can lead to earlier oil deterioration and the need for more frequent oil changes than recommended for the basic excavator. Extra care should also be taken to avoid the entry of dust or dirt when installing or removing a hammer in the field.

Choosing the Tool

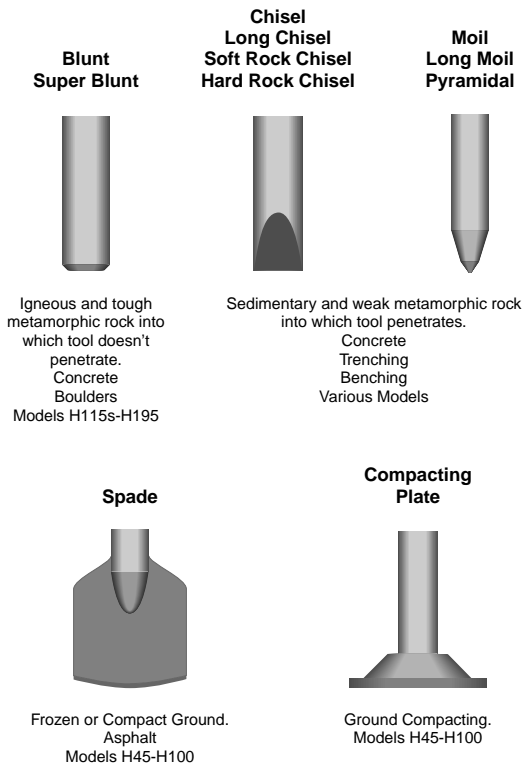

Model	H195		H180s		H160s		H140s	
Working weight	6600 kg	14,520 lb	3800 kg	8360 lb	3000 kg	6600 lb	2200 kg	4840 lb
Impact frequency	300-400 bpm		350-470 bpm		400-600 bpm		360-520 bpm	
Operating pressure	13 500 kPa	1958 psi	16 000 kPa	2321 psi	14 000 kPa	2031 psi	13 500 kPa	1958 psi
Carrier relief pressure	21 000 kPa	3045 psi	21 000 kPa	3045 psi	21 000 kPa	3045 psi	21 000 kPa	3045 psi
Acceptable oil flow	300-400 L/min	78-104 gpm	220-300 L/min	57-78 gpm	210-310 L/min	55-81 gpm	160-230 L/min	42-60 gpm
Maximum back pressure	1000 kPa	145 psi	1000 kPa	145 psi	500 kPa	73 psi	500 kPa	73 psi
Low pressure	—		—		—		—	
Oil temperature	-20°-+80°C	-4°-+176°F	-20°-+80°C	-4°-+176°F	-20°-+80°C	-4°-+176°F	-20°-+80°C	-4°-+176°F
Oil viscosity	15-1000 cSt		15-1000 cSt		15-1000 cSt		15-1000 cSt	
Line Size (minimum)								
ID pressure	36 mm	1.42"	32 mm	1.25"	25 mm	1"	25 mm	1"
ID return	42 mm	1.65"	36 mm	1.42"	32 mm	1.25"	32 mm	1.25"
	or 2 × 32 mm							
2 × 1.25"								
Certified CIMA tool energy*	9275 J	6841 ft-lb	5906 J	4357 ft-lb	4873 J	3594 ft-lb	3976 J	2934 ft-lb

Model	H130s		H120Cs		H115s		H100	
Working weight	1700 kg	3740 lb	1300 kg	2860 lb	1000 kg	2200 lb	730 kg	1605 lb
Impact frequency	330-610 bpm		400-620 bpm		400-700 bpm		470-1000 bpm	
Operating pressure	14 500 kPa	2103 psi	14 000 kPa	2031 psi	14 000 kPa	2031 psi	14 500 kPa	2103 psi
Carrier relief pressure	21 000 kPa	3045 psi	21 000 kPa	3045 psi	21 000 kPa	3045 psi	21 000 kPa	3045 psi
Acceptable oil flow	120-220 L/min	31-57 gpm	120-160 L/min	31-42 gpm	70-130 L/min	18-34 gpm	60-120 L/min	16-31 gpm
Maximum back pressure	1000 kPa	145 psi	1000 kPa	145 psi	1000 kPa	145 psi	1000 kPa	145 psi
Low pressure	—		—		—		—	
Oil temperature	-20°-+80°C	-4°-+176°F	-20°-+80°C	-4°-+176°F	-20°-+80°C	-4°-+176°F	-20°-+80°C	-4°-+176°F
Oil viscosity	15-1000 cSt		15-1000 cSt		15-1000 cSt		15-1000 cSt	
Line Size (minimum)								
ID pressure	32 mm	1.25"	25 mm	1"	25 mm	1"	25 mm	1"
ID return	32 mm	1.25"	25 mm	1"	25 mm	1"	25 mm	1"
Certified CIMA tool energy*	3739 J	2758 ft-lb	2884 J	2127 ft-lb	1481 J	1092 ft-lb	1152 J	850 ft-lb

*Measured in accordance with the CIMA measuring guide for tool energy rating for hydraulic breakers developed by the Mounted Breaker Manufacturers Bureau of the Construction Industry Manufacturers Association (CIMA-MBMB).

Model	H90C		H70/H70s		H63/H63s	
Working weight ¹	480 kg	1056 lb	370/400 kg	814/880 lb	275 kg	605 lb
Impact frequency ²	500-1300 bpm		600-1800 bpm		400-2000 bpm	
Hammer operating pressure	13 500 kPa	1958 psi	12 500 kPa	1813 psi	14 000 kPa	2031 psi
Carrier relief pressure	21 000 kPa	3045 psi	21 000 kPa	3045 psi	21 000 kPa	3045 psi
Acceptable oil flow	60-150 L/min	16-39 gpm	50-150 L/min	13-39 gpm	20-100 L/min	5-26 gpm
Maximum back pressure	2000 kPa	290 psi	3000 kPa	435 psi	3500 kPa	508 psi
Low pressure	3300 kPa	479 psi	3900 kPa	566 psi	3100 kPa	450 psi
Oil temperature working range	-20°-+80°C	-4°-+176°F	-20°-+80°C	-4°-+176°F	-20°-+80°C	-4°-+176°F
Oil viscosity	15-1000 cSt		15-1000 cSt		15-1000 cSt	
Line size (minimum)						
ID pressure	25 mm	1"	25 mm	1"	19 mm	0.75"
ID return	25 mm	1"	25 mm	1"	19 mm	0.75"
Certified CIMA tool energy*	735 J	542 ft-lb	622 J	459 ft-lb	372 J	274 ft-lb

Model	H50/H50s		H45/H45s	
Working weight ¹	180/208 kg	396/458 lb	125/131 kg	275/288 lb
Impact frequency ²	450-1800 bpm		750-2200 bpm	
Hammer operating pressure	10 500 kPa	1523 psi	11 500 kPa	1668 psi
Carrier relief pressure	21 000 kPa	3045 psi	21 000 kPa	3045 psi
Acceptable oil flow	20-70 L/min	5-18 gpm	20-50 L/min	5-13 gpm
Maximum back pressure	3000 kPa	435 psi	3000 kPa	435 psi
Low pressure	—		3100 kPa	450 psi
Oil temperature working range	-20°-+80°C	-4°-+176°F	-20°-+80°C	-4°-+176°F
Oil viscosity	15-1000 cSt		15-1000 cSt	
Line size (minimum)				
ID pressure	15 mm	0.62"	12 mm	0.5"
ID return	15 mm	0.62"	12 mm	0.5"
Certified CIMA tool energy*	198 J	146 ft-lb	137 J	101 ft-lb

¹ Includes standard tool.

² Approximate value, actual impact frequency depends on oil flow, oil viscosity, temperature, and materials to be broken.

Backhoe Loaders equipped with hydraulic hammers are well-suited to breaking concrete, asphalt and hard or frozen ground. Rock applications require hammers classed at 2710 J (**2000 ft-lb**) and above.

*Measured in accordance with the CIMA measuring guide for tool energy rating for hydraulic breakers developed by the Mounted Breaker Manufacturers Bureau of the Construction Industry Manufacturers Association (CIMA-MBMB).

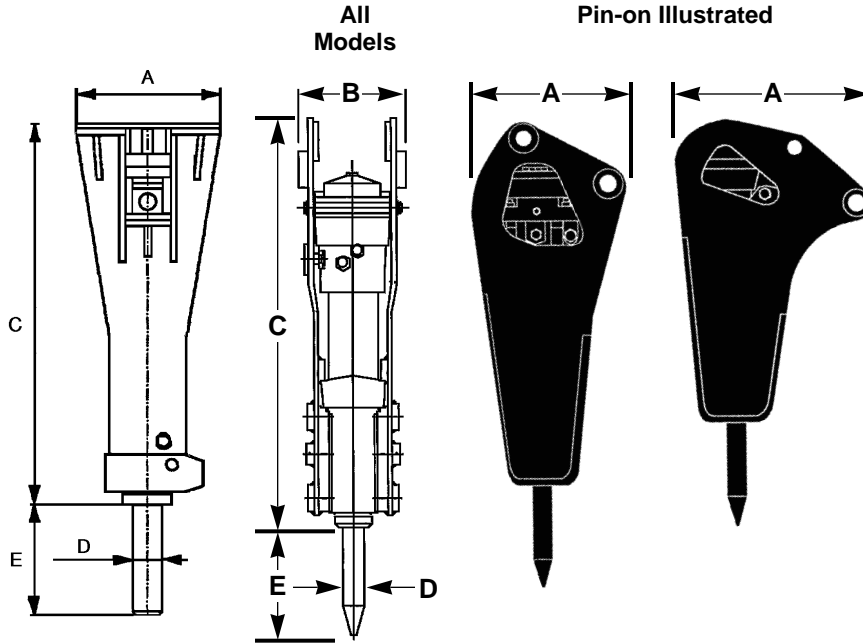

Model	A		B		C		D		E	
	mm	in	mm	in	mm	in	mm	in	mm	in
H195	1090	42.9	1090	42.9	2805	110.4	195	7.7	732	28.8
H180s	730	28.7	730	28.7	2458	96.8	170	6.7	542	21.3
H160s	730	28.7	730	28.7	2306	90.8	160	6.3	560	22.0
H140s	585	23.0	540	21.3	2058	81.0	140	5.5	469	18.5
H130s	585	23.0	540	21.3	1870	73.6	130	5.1	397	15.6
H120Cs	585	23.0	540	21.3	1753	69.0	115	4.5	357	14.1
H115s	585	23.0	540	21.3	1595	62.8	106	4.2	390	15.4
H100	585	23.0	540	21.3	1380	54.3	95	3.7	459	18.1
H100s	585	23.0	540	21.3	1390	54.7	95	3.7	459	18.1
H100 (pin-on)	588	23.1	450	17.7	1512	59.5	95	3.7	459	18.1
H90C	510	20.1	380	15.0	1269	50.0	84	3.3	417	16.4
H90Cs	520	20.5	400	15.7	1277	50.3	84	3.3	417	16.4
H90C (pin-on)	888	35.0	348	13.7	1153	45.4	84	3.3	445	17.5
H70	470	18.5	380	15.0	1134	44.6	70	2.8	355	14.0
H70s	520	20.5	400	15.7	1150	45.3	70	2.8	355	14.0
H70 (pin-on)	771	30.4	348	13.7	1215	48.3	70	2.8	355	14.0
H70s (pin-on)	771	30.4	348	13.7	1215	48.3	70	2.8	355	14.0
H63	470	18.5	380	15.0	1025	40.4	63	2.5	364	14.3
H63s	440	17.3	380	15.0	1006	39.6	63	2.5	364	14.3
H50	340	13.4	280	11.0	920	36.2	50	2.0	261	10.3
H50s	440	17.3	316	12.4	893	35.2	50	2.0	262	10.3
H45	340	13.4	280	11.0	775	30.5	45	1.8	262	10.3
H45s	440	17.3	280	11.0	775	30.5	45	1.8	249	9.8

Hammer Model	Machine Model(s)	Recommended Carrier Weight	
		kg	lb
H195	375	60 000-100 000	132,000-220,000
H180s	375, 350, 345B	40 000-80 000	88,000-176,000
H160s	350, 345B, 330B	32 000-55 000	70,400-121,000
H140s	330B, 325B, 322B	25 000-40 000	55,000-88,000
H130s	325B, 322B, M320, 320B	19 000-32 000	41,800-70,400
H120s	325B, 322B, M320, 320B, M318, 317B, M315, 315B	17 000-26 000	37,400-57,200
H115s	M320, 320B, M318, 317B, 315B, M312, 312B, M315	12 000-20 000	26,400-44,000
H100	446B, M315, M312, 315B, 312B, 311B	8000-14 000	17,600-30,800
H90C	446B, 436C, 426C, 312B, 311B, 307B	7000-12 000	15,400-26,400
H70	428C, 436C, 426C, 416C, 307	5000-8000	11,000-17,600
H63	416C	3000-6500	6600-14,300
H50	302.5	2500-4500	5500-9900
H45	302.5, 301.5	1300-3200	2860-7040

Model H140s

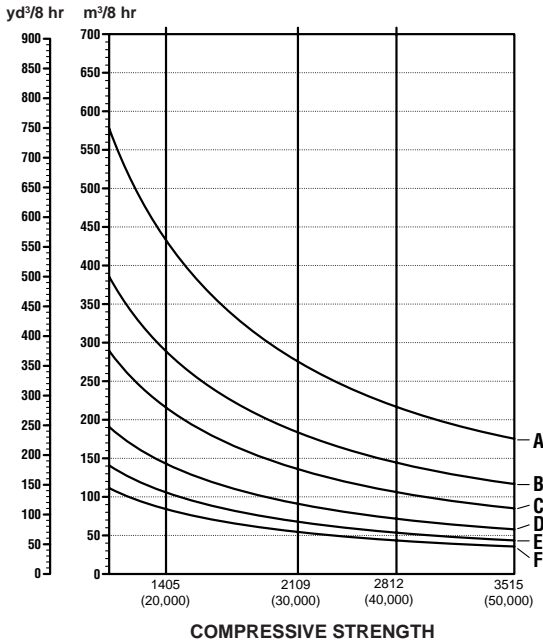

Model H180s

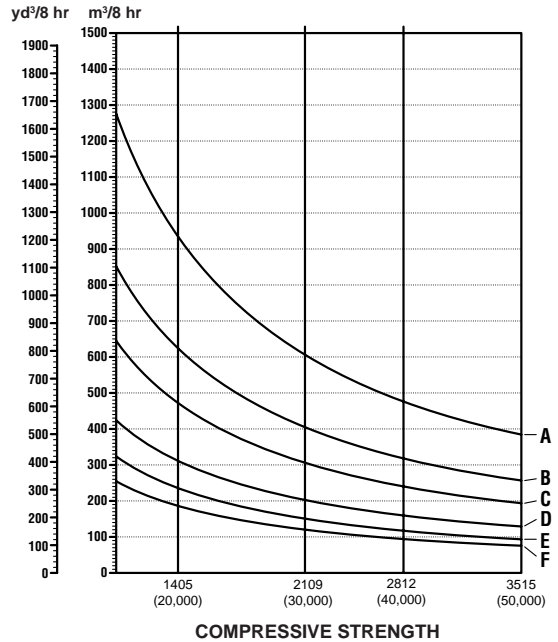

Model H160s

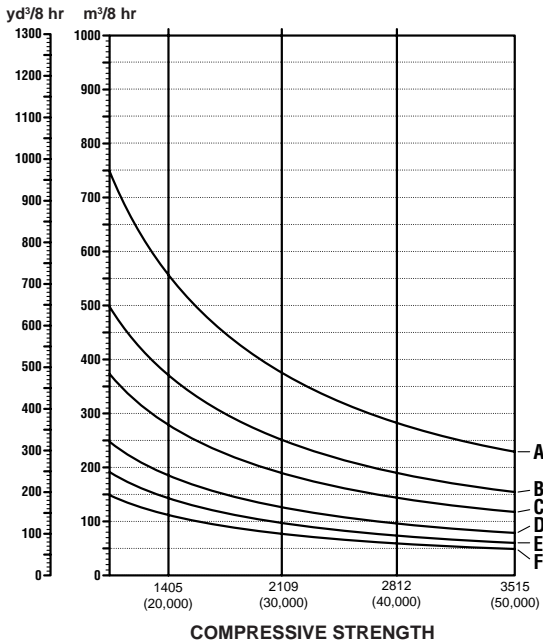

KEY

- A — Bedding thickness less than 20 inches
- B — Bedding thickness — 20 to 40 inches
- C — Bedding thickness — 40 to 80 inches or closely spaced vertical fractures
- D — Some vertical fracturing
- E — Widely spaced vertical fractures
- F — Massive formation

The figures are for comparison and evaluation purposes only. Results will vary depending on operation, carrier and job conditions.

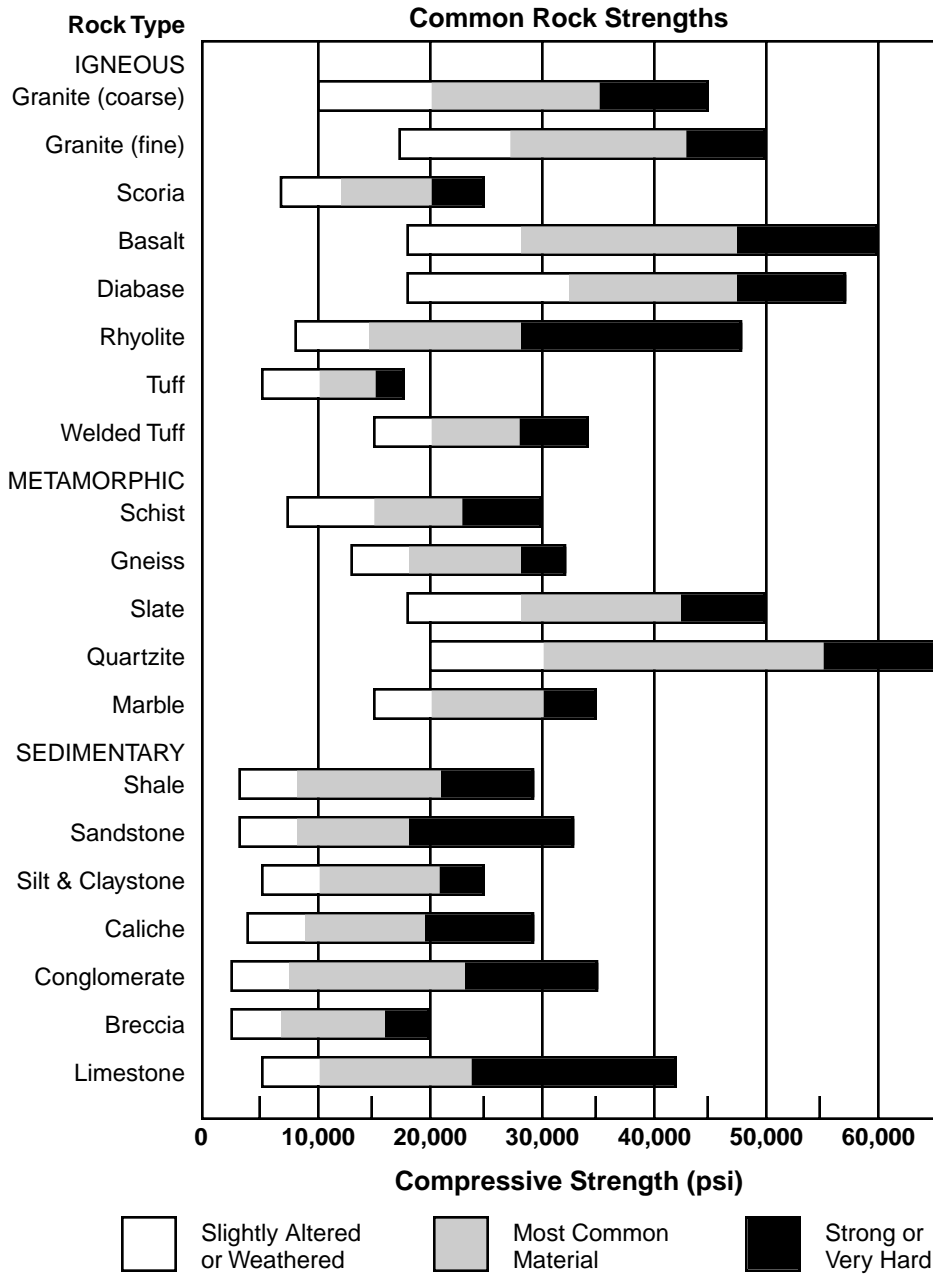

The rock strengths shown are those most commonly encountered by Caterpillar in near surface excavations. Highly altered or deeply weathered rocks can have strength values much lower than those listed. Also, strength values greater than those shown may occasionally be encountered.

- Features
- Applications
- Shearing Capability Table

**MOBILE SCRAP
AND DEMOLITION SHEARS**

Features:

- 180 degree side mounted rotation.
- Precision machined main bolt is field removable.
- 500 Brinell hardness wear plates throughout the upper and lower jaw.
- Hydraulic cylinder rod is protected. When activated the cylinder barrel is pushed out and the rod remains protected by the housing at all times.
- Transportation safety bars are designed to convert the shears to straight shears if the rotator is down for repair or overhaul.

Applications:

The Cat Mobile Scrap and Demolition Shears are widely used for demolishing steel structures, cutting up cars, trucks, farm machinery, railroad cars, large rubber tires, reinforced concrete structures, cables and scrap in general.

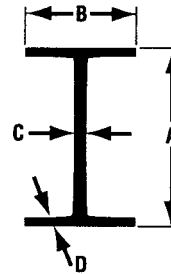

Model	S25		S30		S40		S50		S80		S130	
Narrow I-beams	mm	in	mm	in	mm	in	mm	in	mm	in	mm	in
A Height	320	12.6	400	15.7	425	16.7	500	19.7	550	21.7	600	23.6
B Flange Width	131	5.2	115	6.1	163	6.4	185	7.3	200	7.9	215	8.5
C Web Thickness	11.5	0.45	14.4	0.57	15.3	0.6	18	0.7	19	0.75	21.6	0.85
D Flange Thickness	17.3	0.68	21.8	0.86	23	0.9	27	1.1	30	1.2	32.4	1.28
Wide I-beams												
A Height	171	6.7	230	9.1	250	9.8	330	13	390	15.4	440	17.3
B Flange Width	180	7.1	240	9.4	260	10.2	300	11.8	300	11.8	300	11.8
C Web Thickness	6	0.24	7.5	0.3	7.5	0.3	9.5	0.37	11	0.43	11.5	0.45
D Flange Thickness	9.5	0.37	12	0.47	12.5	0.49	16.5	0.65	19	0.75	21	0.83

The above profiles provide an indication of the shears relative cutting capability. The exact cutting dimensions depend on excavator operating pressure, the conditions of the shear knives and jaws and the steel's tensile strength.

Technical Data (All dimensions are approximate.)

Model	S25		S30		S40	
Approximate Service Weight Excluding Mounting Bracket	2400 kg	5300 lb	3300 kg	7300 lb	4785 kg	10,550 lb
Length	2930 mm	9'7.4"	3500 mm	11'5.8"	4120 mm	13'6"
Jaw Opening	550 mm	1'9.7"	550 mm	1'9.7"	710 mm	2'4"
Jaw Depth	530 mm	1'8.9"	530 mm	1'8.9"	725 mm	2'4"
Primary Cutter Length	300 mm	11.8"	300 mm	11.8"	330 mm	13"
Maximum Shear Force Throat/ Primary Blade Center	3495/ 1800 kN	393/202 st	5030/ 2530 kN	565/283 st	6750/ 3426 kN	759/385 st
Maximum Oil Flow — Hydraulic Cylinder	160 L/min	42 gpm	180 L/min	48 gpm	400 L/min	106 gpm
Maximum Oil Flow — Rotation	15 L/min	4 gpm	17 L/min	4.5 gpm	23 L/min	6.1 gpm
Maximum Working Pressure Hydraulic Cylinder	34 300 kPa	4980 psi	34 300 kPa	4980 psi	34 300 kPa	4980 psi
Rotation	20 200 kPa	2900 psi	20 200 kPa	2900 psi	20 200 kPa	2900 psi
Cycle Time @ Max. Flow Open		4.3 sec		4.7 sec		4.3 sec
Close		7.5 sec		9.2 sec		7.2 sec
Hydraulic Rotation		180°		180°		180°
Approximate Base Machine Operating Weight:						
Boom	18 000 kg	40,000 lb	20 000 kg	44,000 lb	26 000 kg	57,000 lb
Stick	26 000 kg	57,000 lb	30 000 kg	66,000 lb	40 000 kg	88,000 lb

Model	S50		S80		S130	
Approximate Service Weight Excluding Mounting Bracket	6200 kg	13,700 lb	7900 kg	17,500 lb	12 300 kg	27,200 lb
Length	4480 mm	14'8.4"	4650 mm	15'3"	5500 mm	18'0.5"
Jaw Opening	715 mm	2'4.2"	820 mm	2'8.3"	1100 mm	3'7.3"
Jaw Depth	795 mm	2'7.3"	820 mm	2'8.3"	1080 mm	3'6.5"
Primary Cutter Length	450 mm	17.7"	450 mm	17.7"	550 mm	1'9.7"
Maximum Shear Force Throat/ Primary Blade Center	8440/ 3635 kN	949/409 st	9280/ 4310 kN	1043/484 st	11 445/ 5255 kN	1287/591 st
Maximum Oil Flow — Hydraulic Cylinder	400 L/min	106 gpm	450 L/min	119 gpm	800 L/min	211 gpm
Maximum Oil Flow — Rotation	31 L/min	8.2 gpm	53 L/min	14 gpm	47 L/min	12.4 gpm
Maximum Working Pressure Hydraulic Cylinder	34 300 kPa	4980 psi	34 300 kPa	4980 psi	34 300 kPa	4980 psi
Rotation	20 200 kPa	2900 psi	20 200 kPa	2900 psi	20 200 kPa	2900 psi
Cycle Time @ Max. Flow Open		4.6 sec		4.3 sec		4.2 sec
Close		7.8 sec		8.8 sec		8.5 sec
Hydraulic Rotation		180°		180°		180°
Approximate Base Machine Operating Weight:						
Boom	30 000 kg	66,000 lb	40 000 kg	88,000 lb	120 000 kg	265,000 lb
Stick	50 000 kg	110,000 lb	80 000 kg	176,000 lb	N/A	

Matching Guide

Stick Mounted/Reach Boom

Shear Model	Cat Excavator	Stick Range	
		mm	ft
S25	320B	1900	6'3"
	322B	2500-3600	8'2"-11'10"
	325B	2000-4200	6'7"-13'9"
	330B	2150-4800	7'1"-15'9"
S30	325B L	2000-2700	6'7"-8'10"
	330B L	2150-3900	7'1"-12'10"
	345B	2900-4800	9'6"-15'9"
	350 L	3100-4800	10'2"-15'9"
S40	345B	2900-4800	10'2"-12'2"
	350 L	3100-3700	9'6"-15'9"
S50	375 L	2900-5500	9'6"-18'1"
S80	375 L	2900-3400	9'6"-11'2"
	375 L*	2900-4400	9'6"-14'5"

*GP Boom.

Reach Boom Mounted

Shear Model	Cat Excavator
S25	315B L
	320B
	322B
S30	320B
	320B L
	322B
	322B L
	325B L
	330B L
S40	325B L
	330B L
S50	330B L
S80	345B
	350B L
S130	375

CONCRETE PULVERIZERS

Features:

- Hydraulic cylinder rod is protected. When activated the cylinder barrel is pushed out and the rod remains protected by the housing at all times.
- Large diameter slewing ring powered by a hydraulic motor constitutes a rugged and fast 360 degree rotation system.
- P16 and P25 Pulverizers provide the optimum reach configuration. Fifteen replaceable teeth and two square shaped cutting knives.
- P20, P28, P40 and P60 provide the optimum productivity configuration. Twenty-one replaceable teeth with six replaceable square cutting knives.
- Patented staggered tooth design enhances crushing effectiveness of the jaws.
- Long powerful rebar cutters.

Applications:

Primary and secondary demolition in one operation. Ideal for reinforced concrete found in bridge decks, parking garages, support columns and abutments.

Matching Guide

Stick Mounted/Reach Boom

Pulverizer Model	Cat Excavator	Stick Range	
		mm	ft
P16	320B L	1900-2900	6'3"-9'7"
	322B L	2000-3600	6'7"-11'10"
	325B L	2000-4200	6'7"-13'9"
P20	322B L	2000-3600	6'7"-11'10"
	325B L	2000-4200	6'7"-13'9"
P25	325B L	2000-3200	6'7"-10'6"
	330B L	2150-4800	7'1"-15'9"
	345B L	3900-4800	12'10"-15'9"
	350 L	4050-4800	13'3"-15'9"
P28	330B L	2150-3300	7'1"-10'10"
	345B L	3900-4800	12'10"-15'9"
	350 L	4050-4800	13'3"-15'9"
P40	345B L	3900-4800	12'10"-15'9"
	350 L	3100-3700	9'6"-12'2"
	375 L	4400-5500	14'5"-18'1"
P60	375	2900-4400	9'6"-14'5"
	375*	2900-4400	9'6"-14'5"

*GP Boom.

Technical Data (All dimensions are approximate.)

Model	P16		P20		P25	
Approximate Service Weight Excluding Mounting Bracket	2100 kg	4650 lb	2400 kg	5300 lb	3000 kg	6600 lb
Length Excluding Mounting Bracket	2450 mm	8'0.47"	2370 mm	7'9.3"	2730 mm	8'11.48"
Width: Fixed Jaw	530 mm	1'8.87"	635 mm	2'1"	650 mm	2'1.6"
Moving Jaw	305 mm	12"	450 mm	17.7"	400 mm	15.75"
Jaw Opening	750 mm	2'5.53"	650 mm	2'1.7"	900 mm	2'11.43"
Maximum Crushing Force						
Tooth — Jaw's Tip	740 kN	83 st	773 kN	86 st	935 kN	105 st
Tooth — Throat	1235 kN	139 st	1748 kN	197 st	1515 kN	170 st
Maximum Shear Force Cutting Blade Middle (Throat)	2110 kN	237 st	2574 kN	290 st	2990 kN	336 st
Maximum Oil Flow Hydraulic Cylinder	200 L/min	53 gpm	200 L/min	53 gpm	250 L/min	66 gpm
Maximum Oil Flow Rotation	20 L/min	5 gpm	20 L/min	5 gpm	20 L/min	5 gpm
Maximum Working Pressure Hydraulic Cylinder	34 300 kPa	4980 psi	34 300 kPa	4980 psi	34 300 kPa	4980 psi
Maximum Working Pressure Rotation	17 200 kPa	2465 psi	17 200 kPa	2465 psi	17 200 kPa	2465 psi
Cycle Time @ Max. Flow						
Open	2.9 sec		2.9 sec		2.7 sec	
Close	4.6 sec		4.6 sec		5.3 sec	
Hydraulic Rotation Continuous	360°		360°		360°	
Approximate Base Machine Operating Weight	16 000 kg	35,000 lb	20 000 kg	44,000 lb	25 000 kg	55,000 lb

Model	P28		P40		P60	
Approximate Service Weight Excluding Mounting Bracket	3600 kg	7950 lb	5500 kg	12,150 lb	8100 kg	17,900 lb
Length Excluding Mounting Bracket	2650 mm	8'8.3"	2970 mm	9'8.9"	3265 mm	10'8.5"
Width: Fixed Jaw	730 mm	2'4.7"	820 mm	2'8.3"	950 mm	3'1.4"
Moving Jaw	505 mm	1'7.9"	650 mm	2'1.6"	655 mm	2'1.8"
Jaw Opening	850 mm	2'9.5"	1050 mm	3'5.3"	1150 mm	3'9.3"
Maximum Crushing Force						
Tooth — Jaw's Tip	880 kN	99 st	1533 kN	173 st	1920 kN	216 st
Tooth — Throat	1973 kN	222 st	3776 kN	464 st	4130 kN	464 st
Maximum Shear Force Cutting Blade Middle (Throat)	2853 kN	320 st	5931 kN	667 st	5770 kN	649 st
Maximum Oil Flow Hydraulic Cylinder	250 L/min	66 gpm	400 L/min	106 gpm	600 L/min	159 gpm
Maximum Oil Flow Rotation	20 L/min	5 gpm	20 L/min	5 gpm	20 L/min	5 gpm
Maximum Working Pressure Hydraulic Cylinder	34 300 kPa	4980 psi	34 300 kPa	4980 psi	34 300 kPa	4980 psi
Maximum Working Pressure Rotation	17 200 kPa	2465 psi	17 200 kPa	2465 psi	17 200 kPa	2465 psi
Cycle Time @ Max. Flow						
Open	2.7 sec		3.4 sec		3.7 sec	
Close	5.3 sec		6.6 sec		6.3 sec	
Hydraulic Rotation Continuous	360°		360°		360°	
Approximate Base Machine Operating Weight	28 000 kg	62,000 lb	40 000 kg	88,000 lb	60 000 kg	132,000 lb

CONCRETE CRUSHERS

Features:

- Two powerful hydraulic cylinders protected from damage by the unique static rod design.
- Each crushing arm has two cutters and two crushing teeth.
- Replaceable cutters and teeth are bolted and tack welded to the jaw.
- Rebar cutters have four cutting edges.
- Large diameter slewing ring powered by a hydraulic motor constitutes a rugged and fast 360 degree rotation system.

Applications:

Primary demolition where productivity is crucial, reinforced concrete structures with thick walls and large diameter columns. Also used on bridge decks, parking garages, support columns and abutments with a thickness of up to five feet.

Matching Guide

Stick Mounted/Reach Boom

Crusher Model	Cat Excavator	Stick Range	
		mm	ft
CR20	320B L	1900-3900	6'3"-12'10"
	322B L	2000-3600	6'7"-11'10"
CR28	325B L	2000-3200	6'7"-10'6"
	330B L	2150-3900	7'1"-12'10"
	345B L	4800	15'9"
	350 L	4800	15'9"
CR35	345B L	2900-3900	9'6"-12'10"
	350 L	3100-4050	10'2"-13'3"
CR50	375	2900-5500	9'6"-18'1"
	375*	2900-5500	9'6"-18'1"

*GP Boom.





Technical Data (All dimensions are approximate.)

Model	CR20		CR28		CR35		CR50	
Approximate Service Weight Excluding Mounting Bracket	2500 kg	5500 lb	3300 kg	7300 lb	4600 kg	10,200 lb	6500 kg	14,400 lb
Length Excluding Mounting Bracket	2100 mm	6'10.7"	2235 mm	7'7.9"	2620 mm	8'7.1"	2850 mm	9'4.2"
Jaw Opening (Maximum)	720 mm	2'4.3"	915 mm	3'0"	1190 mm	3'10.8"	1600 mm	5'3"
Cutter Length	280 mm	11"	400 mm	15.8"	500 mm	1'7.7"	450 mm	17.7"
Maximum Crushing Force								
Tip	719 kN	81 st	793 kN	90 st	836 kN	94 st	1426 kN	161 st
Middle Tooth	965 kN	108 st	1169 kN	131 st	1233 kN	139 st	1909 kN	214 st
Maximum Shear Force — Cutting	3593 kN	403 st	4815 kN	541 st	4987 kN	561 st	7262 kN	816 st
Maximum Oil Flow Hydraulic Cylinder	160 L/min	42 gpm	180 L/min	48 gpm	250 L/min	66 gpm	450 L/min	119 gpm
Maximum Oil Flow Rotation	20 L/min	5 gpm	20 L/min	5 gpm	20 L/min	5 gpm	20 L/min	5 gpm
Maximum Working Pressure Hydraulic Cylinder	34 300 kPa	4980 psi	34 300 kPa	4980 psi	34 300 kPa	4980 psi	34 300 kPa	4980 psi
Maximum Working Pressure Rotation	17 200 kPa	2465 psi	17 200 kPa	2465 psi	17 200 kPa	2465 psi	17 200 kPa	2465 psi
Cycle Time @ Max. Flow								
Open		3.2 sec		3.2 sec		3.3 sec		3.2 sec
Close		5.1 sec		6.2 sec		5.5 sec		6.7 sec
Hydraulic Rotation Continuous		360°		360°		360°		360°
Approximate Base Machine Operating Weight	20 000 kg	44,000 lb	28 000 kg	62,000 lb	35 000 kg	77,000 lb	50 000 kg	110,000 lb

ENGINES

CONTENTS

Design data19-2
 Rating explanations19-2
 Industrial Diesel Engines19-3
 Fire Pump Engines19-7
 Industrial Gaseous Fueled Engines19-8
 Generator Sets — Diesel — 50 Hz19-10
 Generator Sets — Diesel — 60 Hz19-11
 Olympian Generator Sets19-12
 Generator Sets — Gaseous Fueled19-13
 Marine Propulsion — Rating Levels19-15
 Marine Generator Sets19-18
 Marine Auxiliary Engines19-19
 Truck Diesel Engines19-20

	TYPE	NO. OF MODELS	RANGE
	Diesel	20	56 to 4920 kW 76 to 6600 hp EPA Certified
	Gaseous Fueled	13	30 to 3506 kW 40 to 4700 hp EPA Certified
GENERATOR SETS			50 HZ-kV•A w/fan Prime-112 to 1944 Standby-125 to 2250 w/o fan Prime-1960 to 6500 Standby-2160 to 7150
	Diesel	13	60 HZ-kW w/fan Prime-113 to 1825 Standby-125 to 2000 w/o fan 1525 to 4840
	Gaseous Fueled	12	50 HZ-kV•A w/o fan Continuous-45 to 3385 60 HZ-kW w/o fan Continuous-55 to 3050
OLYMPIAN GENERATOR SETS*			50 HZ-kV•A w/fan Prime-6 to 100 Standby-8 to 200 60 HZ-kV•A w/fan Prime-6 to 100 Standby-8 to 200
	Gaseous Fueled		50 HZ-kV•A w/fan Prime-6 to 50 Standby-12 to 100 60 HZ-kV•A w/fan Prime-6 to 50 Standby-12 to 100
MARINE			
	Propulsion	17	63 to 5420 kW 85 to 7270 hp
	Generator Sets	12	50 HZ kV•A 63 to 6500 Prime 60 HZ-kW 65 to 4840 Prime
TRUCK			
	Diesel	9	123 to 410 kW 170 to 550 hp EPA, CARB and Canadian certified

*Olympian Generator Sets are manufactured exclusively for Caterpillar dealers.

DESIGN DATA**Diesel Engines**

Bearings — Precision-type steel-backed aluminum alloy with lead-tin overlay copper bonded to bearing surface. High load carrying ability and exceptional fatigue strength.

Block — Cast from high tensile strength grey iron. Internal ribbing provides added strength.

Cooling — Built-in, gear driven centrifugal pump (belt driven for 3116 and 3208) circulates jacket water through engine at all times. Water temperature is thermostatically controlled. Heat exchangers and radiators are available.

Crankshaft — Forged steel, dynamically balanced, heat treated and superfinished.

Cylinder Liners — Internal surface induction hardened (1.7 L, 3300, 3400, 3500 and 3600 Families) for excellent wear life. Full-length watercooled for efficient heat transfer.

Fuel System — Adjustment free for reduced engine maintenance, individual fuel injection pumps have built-in calibration — no adjustment required after fuel nozzle replacement (1.7 L, 3500 and 3600 families have unit injectors). 3126, 3408E and 3412E use the Caterpillar Hydraulic Electronic Fuel Injection (HEUI) system.

Governor — Hydra-mechanical (Woodward 3161 on 3500 and 3600 Families) for reliability, good response and smooth, stable load changes.

Lubrication — Positive displacement gear pump maintains continuous flow of lubricant under pressure to all moving parts. Full-flow filtration is provided by replaceable cellulose filters. Watercooled oil cooler maintains proper oil temperature.

Pistons — Three-ring design (two-ring on 3208) reduces friction, provides excellent oil control, and increases engine efficiency.

Starting — Electric and air starting systems are offered for most models.

Valves — Hardened steel alloy. Valves rotate 3° each time they lift to seat in a new position and allow even heat distribution (except for 3116).

Gaseous Fueled Engines

Combustion System — The piston design and compression ratios available provide the ability to utilize a wide variety of gaseous fuels as well as provide low emission output (below 2.0 grams/bhp-hr No_x).

Fuel System — Heavy-duty, industrial-type carburetors designed to maintain optimum air-fuel ratio at all loads and speeds.

Ignition System — Caterpillar Gaseous Fueled Engines employ a low tension magneto, together with an ignition transformer (one at each cylinder), to provide up to 34 kV to spark plugs. The Cat Electronic Ignition system is also available on certain engines.

RATING EXPLANATIONS

All engine ratings listed include such standard accessories as air cleaner and fuel, lube, and jacket water pumps. Power required for auxiliaries such as cooling fans, air compressors, charging alternators, special pumps, etc., must be deducted to arrive at the net power available to drive the load (except as noted). Other ratings are available for specific application and customer requirements, i.e., locomotive, oil field, fire pump, irrigation, etc. Consult your Caterpillar Dealer.

Rating Conditions

Performance is based on SAE J1349 standard conditions of 100 kPa (29.61 in Hg) and 25° C (77° F). Performance also applies at ISO 3046/1 (except for Spark Ignited Engines), DIN 6271 and BS 5514 standard conditions of 100 kPa (29.61 in Hg), 27° C (81° F) and 60% relative humidity.

Fuel consumption is based on fuel oil having an LHV of 42 780 kJ/kg (18,390 Btu/lb) and weighing 838.9 g/liter (7.001 lb/U.S. gal). All ratings are based on distillate fuel.

Altitude and Temperature Capabilities

Industrial Diesel Engines — Most intermittent and continuous ratings are applicable to at least 1320 m (5,000 ft) elevation without derating. Consult factory for specific applications.

Gaseous Fueled Engines — Ratings for turbocharged and aftercooled engines are generally applicable to 1500 m (5000 ft). Naturally aspirated engines are applicable to 150 m (500 ft).

Diesel Truck Engines — Refer to specification sheets for altitude capability of individual truck engine ratings.

Cat Diesel Engines for Industrial Applications

Model Type	"Ind A" Continuous			"Ind B"			"Ind C" Intermittent			"Ind D"			"Ind E"			EPA Certified
	kW	hp	rpm	kW	hp	rpm	kW	hp	rpm	kW	hp	rpm	kW	hp	rpm	
3054 NA	46	62	2200	—	—	—	—	—	—	51	69	2200	—	—	—	
3054 NA	56	76	2400	—	—	—	65	87	2600	—	—	—	—	—	—	
3304 NA	63	85	2000	67	90	2000	75	100	2200	—	—	—	82	110	2200	
3116 T	—	—	—	86	115	1800	—	—	—	—	—	—	—	—	—	X
3116 TA	—	—	—	97	130	1800	—	—	—	—	—	—	—	—	—	X
3304 NA (PC)	63	85	2000	—	—	—	75	100	2200	—	—	—	—	—	—	X
3054 T	72	96	2400	—	—	—	83	111	2600	—	—	—	—	—	—	
3056 NA	84	114	2400	—	—	—	96	129	2600	—	—	—	—	—	—	
3304 T (PC)	93	125	2000	—	—	—	123	165	2200	—	—	—	—	—	—	
3208 NA	93	125	2400	112	150	2400	131	175	2800	—	—	—	—	—	—	
3304 T	93	125	2000	112	150	2000	123	165	2200	131	175	2200	138	185	2200	
3306 NA (PC)	93	125	2000	—	—	—	112	150	2200	—	—	—	—	—	—	
3306 NA	93	125	2000	101	135	2000	112	150	2200	119	160	2200	127	170	2200	
3116 T	97	130	2200	104	140	2200	108	145	2200	119	160	2200	119	160	2200	X
3116 T	104	140	2400	112	150	2400	116	155	2400	123	165	2400	123	165	2400	X
3116 TA	104	140	2200	112	150	2200	119	160	2200	146	195	2200	168	225	2200	X
3056 T	105	140	2400	—	—	—	119	159	2600	—	—	—	—	—	—	
3116 TA	104	140	2200	112	150	2200	119	160	2200	142	190	2200	142	190	2200	X
3116 T	—	—	—	—	—	—	127	170	2600	127	170	2600	127	170	2600	X
3116 T	104	140	2400	112	150	2400	116	155	2400	123	165	2400	123	165	2400	X
3116 TA	—	—	—	119	160	1800	134	180	1800	—	—	—	—	—	—	X
3116 TA	112	150	2400	123	165	2400	131	175	2400	157	210	2400	164	220	2400	X
3116 TA	—	—	—	—	—	—	142	190	2600	142	190	2600	142	190	2600	X
3208 NA	112	150	2400	—	—	—	157	210	2800	—	—	—	—	—	—	X
3208 T	—	—	—	131	175	2400	—	—	—	—	—	—	—	—	—	
3306 T	116	155	2000	131	175	2000	149	200	2200	—	—	—	—	—	—	
3208 T	119	160	2200	119	160	2200	123	165	2200	131	175	2200	138	185	2200	X
3116 TA	112	150	2400	123	165	2400	131	175	2400	146	200	2400	149	200	2400	X
3056 TA	119	160	2400	—	—	—	135	181	2600	—	—	—	—	—	—	
3306 T	127	170	2000	149	200	2000	168	225	2200	—	—	—	—	—	—	
3116 TA	131	175	2200	138	185	2200	145	195	2200	164	220	2200	164	220	2200	
3116 TA	131	175	2200	138	185	2200	145	195	2200	153	205	2200	153	205	2200	X
3116 TA	142	190	2400	149	200	2400	157	210	2400	172	230	2400	172	230	2400	
3116 TA	—	—	—	—	—	—	172	230	2600	179	240	2600	179	240	2600	
3116 ATAAC	—	—	—	—	—	—	172	230	2450	—	—	—	—	—	—	X
3116 TA	—	—	—	—	—	—	194	260	2600	201	270	2600	201	270	2600	
3306 T (PC)	142	190	2000	—	—	—	187	250	2200	—	—	—	—	—	—	
3306 T	142	190	2000	168	225	2000	187	250	2200	198	265	2200	205	275	2200	
3306	142	190	2000	157	210	2000	168	225	2000	160	215	2200	160	215	2200	X
3208 T	142	190	2400	142	190	2400	157	210	2600	—	—	—	—	—	—	X
3116 TA	142	190	2400	149	200	2400	157	210	2400	157	210	2400	157	210	2400	X
3208 T	149	200	2400	—	—	—	168	225	2600	—	—	—	—	—	—	
3208 T	—	—	—	—	—	—	187	250	2600	194	260	2600	194	260	2600	X
3208 T	149	200	2400	168	225	2400	187	250	2600	—	—	—	—	—	—	
3306 DITA	157	210	2000	172	230	2000	186	250	2200	198	265	2200	205	275	2200	X
3306 TA (PC)	160	215	2000	—	—	—	201	270	2200	—	—	—	—	—	—	
3126 TA	160	215	2200	172	230	2200	179	240	2200	186	250	2200	190	255	2200	X
3126 TA	164	220	2400	172	230	2400	179	240	2400	190	255	2400	194	260	2400	X
3126 TA	—	—	—	—	—	—	186	250	2500	186	250	2500	186	250	2500	X
3126 TA	—	—	—	—	—	—	194	260	2600	194	260	2600	194	260	2600	X

NA — Naturally Aspirated
T — Turbocharged
TA — Turbocharged-Aftercooled
PC — Pre-combustion Chamber
ATAAC — Air-to-air Aftercooled
DITA — Direct Injection Turbocharged-Aftercooled

(Continued on next page)

Cat Diesel Engines for Industrial Applications (cont'd)

Model Type	"Ind A" Continuous			"Ind B"			"Ind C" Intermittent			"Ind D"			"Ind E"			EPA Certified
	kW	hp	rpm	kW	hp	rpm	kW	hp	rpm	kW	hp	rpm	kW	hp	rpm	
3208 T	172	230	2400	183	245	2400	205	275	2600	213	285	2600	220	295	2600	
3116 ATAAC	—	—	—	—	—	—	205	275	2450	—	—	—	—	—	—	X
3208 JWAC	183	245	2400	183	245	2400	224	300	2600	224	300	2400	224	300	2400	X
3208 ATAAC	187	250	2200	187	250	2200	187	250	2200	209	280	2200	209	280	2200	
3306 TA	194	260	2000	205	275	2000	224	300	2200	231	310	2200	243	325	2200	
3406 TA	199	267	1300	—	—	—	199	267	1300	—	—	—	—	—	—	
3406 T	201	270	1800	224	300	2000	242	325	2100	283	380	2100	291	390	2100	
3306 TA	205	275	2000	220	295	2000	242	325	2200	246	330	2200	250	335	2200	X
3208 ATAAC	205	275	2400	209	280	2400	224	300	2600	235	315	2600	246	330	2600	
3406 TA	205	275	1800	242	325	2000	269	360	2100	313	420	2100	336	450	2100	
3306 DITA	205	275	2000	216	290	2000	242	325	2200	246	330	2200	250	335	2200	X
3306 DITA	205	275	2000	216	290	2000	224	300	2200	239	320	2200	250	335	2200	X
3208 ATAAC	224	300	2400	224	300	2400	224	300	2400	235	315	2400	235	315	2400	
3208 ATAAC	—	—	—	—	—	—	231	310	2600	246	330	2600	246	330	2600	
3176B ATAAC	—	—	—	—	—	—	272	365	2100	298	400	2100	—	—	—	X
3196 TA	—	—	—	—	—	—	272	365	1800	—	—	—	—	—	—	
3196 TA	—	—	—	—	—	—	272	365	2100	—	—	—	—	—	—	
3176B ATAAC	231	310	2100	250	335	2100	255	342	1800	291	390	2100	317	425	2100	X
3406 TA (PC)	—	—	—	—	—	—	280	375	2100	—	—	—	—	—	—	
3408 TA	238	319	1200	—	—	—	261	350	1200	—	—	—	—	—	—	
3406 TA	242	325	1800	276	370	2000	298	400	2100	358	480	2100	373	500	2100	
3408 T	242	325	1800	272	365	2000	317	425	2100	339	455	2100	358	480	2100	
3196 TA	276	370	1800	298	400	1800	317	425	1800	339	455	1800	373	500	1800	
3196 TA	276	370	2100	298	400	2100	317	425	2100	339	455	2100	373	500	2100	
3406C DITA	287	385	1800	328	440	2000	343	460	2100	373	500	2100	384	515	2100	X
3406C DITA	280	375	1800	291	390	2000	298	400	2100	324	435	2100	362	485	2100	X
3406C DITA	268	360	1800	268	360	2000	268	360	2100	298	400	2100	324	435	2100	X
3406C DITA	257	345	1800	254	340	2000	250	335	2100	—	—	—	—	—	—	X
3406 TA	313	420	1800	328	440	2000	343	460	2100	384	515	2100	392	525	2100	
3456 TA	—	—	—	—	—	—	410	550	2100	—	—	—	—	—	—	
3406E ATAAC	—	—	—	—	—	—	392	525	2100	421	565	2100	429	575	2100	X
3456 TA	—	—	—	—	—	—	391	525	2100	—	—	—	—	—	—	
3406E ATAAC	317	425	1800	317	425	2000	336	450	2100	—	—	—	—	—	—	X
3408 TA (PC)	—	—	—	—	—	—	354	475	2100	—	—	—	—	—	—	
3412 TA (S)	317	425	1200	—	—	—	399	535	1300	—	—	—	—	—	—	
3456 TA	317	425	1800	336	450	2000	336	450	1800	—	—	—	—	—	—	
3456 TA	336	450	1800	354	475	2000	354	475	1800	—	—	—	—	—	—	
3456 TA	354	475	1800	373	500	2000	373	500	1800	421	565	2100	429	575	2100	
3408E TA	354	475	1800	392	525	2000	373	500	1800	—	—	—	—	—	—	X
3408 TA	347	465	1800	366	490	2000	377	505	2100	392	525	2100	399	535	2100	
3408C TA	347	465	1800	365	490	2000	377	505	2100	392	525	2100	399	535	2100	X
3456 TA	—	—	—	—	—	—	410	550	2100	—	—	—	—	—	—	
3408E TA	—	—	—	—	—	—	429	575	2100	466	625	2100	504	675	2100	X
3456 TA	—	—	—	—	—	—	429	575	2100	—	—	—	—	—	—	
3412 T (S)	354	475	1800	384	515	2000	429	575	2100	522	700	2100	552	740	2100	
3408E ATAAC	—	—	—	—	—	—	466	625	2100	522	700	2100	660	750	2100	X
3456 TA	373	500	1800	391	525	2000	391	525	1800	447	600	2100	466	625	2100	
3456 TA	—	—	—	—	—	—	447	600	2100	—	—	—	—	—	—	
3412 T (D)	373	500	1800	410	550	2000	485	650	2100	503	675	2100	522	700	2100	

T — Turbocharged
TA — Turbocharged-Aftercooled
PC — Pre-combustion Chamber
ATAAC — Air-to-air Aftercooled
DITA — Direct Injection Turbocharged-Aftercooled
JWAC — Jacket Water Aftercooled

(Continued on next page)

Cat Diesel Engines for Industrial Applications (cont'd)

Model Type	"Ind A" Continuous			"Ind B"			"Ind C" Intermittent			"Ind D"			"Ind E"			EPA Certified
	kW	hp	rpm	kW	hp	rpm	kW	hp	rpm	kW	hp	rpm	kW	hp	rpm	
3412E DITA	418	560	1800	447	600	2000	485	650	2100	522	700	2100	552	740	2100	
3412E DITA	373	500	1800	448	600	2000	485	650	2100	—	—	—	—	—	—	
3456 TA	384	515	1800	410	550	2000	410	550	1800	470	630	2100	492	660	2100	
3412E DITA	433	580	1800	507	680	2000	560	750	2100	—	—	—	—	—	—	
3412 TA	533	715	1800	541	725	2000	559	750	2100	656	880	2100	716	960	2100	X
3508 TA	507	680	1200	—	—	—	612	820	1300	—	—	—	—	—	—	
3412 TA (D)	533	715	1800	552	740	2000	559	750	2100	656	880	2100	716	960	2100	
3412 DITA	533	715	1800	541	725	2000	559	750	2100	656	880	2100	716	960	2100	X
3412E DITTA	548	735	1800	560	750	2000	560	750	2100	—	—	—	—	—	—	
3508 TA	578	775	1800	—	—	—	634	850	1800	—	—	—	—	—	—	
3508 TA	638	855	1800	697	935	1800	746	1000	1800	—	—	—	—	—	—	
3512 TA	761	1020	1200	—	—	—	858	1150	1300	—	—	—	—	—	—	
3512 TA	877	1175	1800	—	—	—	1007	1350	1800	—	—	—	—	—	—	
3512 TA	955	1280	1800	1048	1405	1800	1119	1500	1800	—	—	—	—	—	—	
3516 TA	1011	1355	1200	—	—	—	1242	1665	1300	—	—	—	—	—	—	
3516 TA	1156	1550	1800	—	—	—	1268	1700	1800	—	—	—	—	—	—	
3516 TA	1275	1710	1800	1391	1865	1800	1492	2000	1800	—	—	—	—	—	—	

TA — Turbocharged-Aftercooled

DITA — Direct Injection Turbocharged-Aftercooled

DITTA — Direct Injection Twin Turbocharged-Aftercooled

Rating Definitions:

NOTE: Application examples are for reference only. For an exact determination of the appropriate rating, contact the factory or your local Caterpillar Dealer.

Rating conditions:

All ratings are based on SAE J1349 standard ambient conditions of 29.6 in Hg (100 kPa), 30% relative humidity and 77°F (25°C). Ratings also apply to AS1501, BS5514, DIN6271 and ISO3046/1 standard conditions.

Power is based on API gravity of 35 at 60°F (15°C), fuel having a LHV of 18,390 Btu/lb (42 780 kJ/kg) used at 84°F (29°C) with a density of 7.001 lb/U.S. gal (838.9 g/L).

Ratings are the total output capability of the engine equipped with standard accessories: lube oil, fuel oil and jacket water pumps.

A Rating (Continuous):

- For heavy-duty services when engine is operated at rated load and speed up to 100% of the time without interruption or load cycling.
- Time at full load up to 100% of the duty cycle.
- Typical application examples include pipeline pumping, ventilation.

B Rating:

- For service where power and/or speed are cyclic.
- Time at full load not to exceed 80% of the duty cycle.
- Typical application examples include irrigation where normal pump demand is 85% of engine rating, oil field mechanical pumping/drilling, stationary/plant air compressors.

C Rating (Intermittent):

- For service where power and/or speed are cyclic. Horsepower and speed capability of the engine can be utilized for one uninterrupted hour followed by one hour of operation at or below the A rating.
- Time at full load not to exceed 50% of the duty cycle.
- Typical application examples include agricultural tractors, harvesters and combines, truck off-highway, fire pumps, blast hole drills, rock crushers, wood chippers with high torque rise, oil field hoisting, and portable air compressors.

D Rating:

- For service where rated power is required for periodic overloads. The maximum horsepower and speed capability of the engine can be utilized for a maximum of 30 uninterrupted minutes followed by one hour at the C rating.
- Time at full load not to exceed 10% of the duty cycle.
- Typical application examples include offshore cranes, runway snow blowers, water well drills, and fire pump certification power.

E Rating:

- For service where rated power is required for a short time for initial starting or sudden overload. For emergency service where standard power is unavailable. Horsepower and speed capability of the engine can be utilized for a maximum of 15 uninterrupted minutes followed by one hour at the C rating or duration of emergency.
- Time at full load not to exceed 5% of the duty cycle.
- Typical application examples include standby centrifugal water pumps, oil field well servicing, crash trucks and gas turbine starters.

Cat Diesel Engines for Industrial Applications (cont'd)

Engine Model	Distillate A Rating (Continuous)			Heavy Fuel A Rating (Continuous)		
	kW	bhp	rpm	kW	bhp	rpm
3606 TA	1490	1998	750	1350	1810	750
3606 TA	1560	2092	800	1355	1817	825
3606 TA	1730	2320	900	1570	2105	900
3606 TA	1850	2481	1000	1680	2253	1000
3608 TA	1980	2655	750	1800	2414	750
3608 TA	2080	2789	800	1800	2414	825
3608 TA	2300	3084	900	2090	2803	900
3608 TA	2460	3299	1000	2240	3004	1000
3612 TA	2980	3996	750	2700	3621	750
3612 TA	3120	4184	800	2710	3634	825
3612 TA	3460	4640	900	3140	4211	900
3612 TA	3700	4962	1000	3360	4506	1000
3616 TA	3960	5310	750	3600	4828	750
3616 TA	4160	5579	800	3600	4828	825
3616 TA	4600	6169	900	4180	5605	900
3616 TA	4920	6598	1000	4480	6008	1000

TA — Turbocharged-Aftercooled

Cat Engines for Fire Pump Packages

Engine Model	Cycl.	Disp.		1460 rpm		1750 rpm		1900 rpm		2100 rpm		2200 rpm	
		L	cu in	kW	hp	kW	hp	kW	hp	kW	hp	kW	hp
3208 NA	V8	10.4	636	75	101	90	121	97	130	105	141	108	145
3208 NA	V8	10.4	636	91	122	105	141	112	150	123	165	127	170
3208 T	V8	10.4	636	108	145	146	196	157	211	175	235	183	245
3306 T	I-6	10.5	638	145	195	172	231	184	247	199	267	—	—
3306 TA	I-6	10.5	638	183	245	198	266	207	278	214	287	—	—
3406 T	I-6	14.6	893	184*	247	218	292	233*	312	246	330	—	—
3406 TA	I-6	14.6	893	224	300	313	420	317	425	321	430	—	—
3406 T	I-6	14.6	893	242†	325	276†	370	280†	375	280†	375	—	—
3406 TA	I-6	14.6	893	—	—	343†	460	343†	460	360†	483	—	—
3408 TA	V8	18.0	1099	—	—	359	481	369	495	378	507	—	—
3408 TA	V8	18.0	1099	—	—	380†	510	392†	525	392†	525	—	—
3412 T	V12	27.0	1649	—	—	401	538	—	—	427	572	—	—
3412 TA	V12	27.0	1649	—	—	476	638	551	739	551	739	—	—
3412 T	V12	27.0	1649	466†	625	492†	660	507†	680	522†	700	—	—
3412 TA	V12	27.0	1649	—	—	597†	800	642†	860	649†	870	—	—
3508 TA	V8	34.5	2105	709*	950	794*	1065	—	—	—	—	—	—
3512 TA	V12	51.8	3158	1067*	1430	1193*	1600	—	—	—	—	—	—
3516 TA	V16	69.0	4210	1417*	1900	1480*	1985	—	—	—	—	—	—

Engine Model	Cycl.	Disp.		2300 rpm		2400 rpm		2600 rpm		2800 rpm		3000 rpm	
		L	cu in	kW	hp	kW	hp	kW	hp	kW	hp	kW	hp
3208 NA	V8	10.4	636	112	150	116	156	119	160	123	165	119	160
3208 NA	V8	10.4	636	131	176	134	180	136	182	139	187	138	185
3208 T	V8	10.4	636	187	251	190	255	194	260	201	270	—	—
3306 T	I-6	10.5	638	203	272	—	—	—	—	—	—	—	—
3306 TA	I-6	10.5	638	212	284	—	—	—	—	—	—	—	—
3406 T	I-6	14.6	893	261†	350	—	—	—	—	—	—	—	—
3406 TA	I-6	14.6	893	339†	455	—	—	—	—	—	—	—	—
3408 TA	V8	18.0	1099	380†	510	—	—	—	—	—	—	—	—
3412 T	V12	27.0	1649	466†	625	—	—	—	—	—	—	—	—
3412 TA	V12	27.0	1649	649†	870	—	—	—	—	—	—	—	—

*This rating is not listed or approved by ULI or FM, but it meets the same standards as the listed or approved ratings.

†These ratings are for engines with dry shielded exhaust manifolds and turbochargers.

T — Turbocharged

NA — Naturally Aspirated

TA — Turbocharged-Aftercooled

Rating Definition:

Standby: Fire pump engine ratings represent the output which may be utilized to drive stationary fire pumps where the pumping equipment has been sized according to ULI and FM procedures.

Engine Model	Compression Ratio	1800 rpm		1600 rpm		1500 rpm		1400 rpm		1200 rpm		1100 rpm		1000 rpm	
		bkW	bhp	bkW	bhp	bkW	bhp	bkW	bhp	bkW	bhp	bkW	bhp	bkW	bhp
G3304 NA	L	63	85	56	75	52	70	48	65	41	55	37	50	34	45
G3304 NA	H	71	95	63	85	60	80	56	75	48	65	45	60	41	55
G3306 NA	L	93	125	82	110	78	103	71	95	62	83	56	75	52	70
G3306 NA	H	108	145	97	130	94	126	86	115	75	100	67	90	60	80
G3306 TA ¹	H	151	203	134	180	123	165	118	158	97	130	90	120	82	110
G3306 TA ²	L	157	211	140	188	138	185	123	164	108	145	101	135	90	125
G3306 TA	H	164	220	145	195	138	185	127	170	108	145	101	135	90	120
G3406 TA ¹	L	242	325	216	290	201	270	187	250	160	215	—	—	134	189
G3406 TA ²	L	272	365	242	325	228	305	209	280	183	245	164	230	153	205
G3406 NA	H	160	215	149	200	138	185	131	175	112	150	101	135	93	125
G3406 TA ²	H	257	345	242	325	227	305	209	280	183	245	164	220	153	205
G3408 TA ²	L	298	400	265	355	250	335	224	300	194	260	179	240	160	215
G3408 TA ¹	L	336	450	298	400	280	375	246	330	213	285	198	265	175	235
G3408 TA ²	H	298	400	265	355	250	335	231	310	198	265	183	245	168	235
G3408 TA ¹	H	336	450	298	400	280	375	261	350	224	300	205	275	187	250
G3408 NA	H	190	255	175	235	168	225	157	210	131	175	119	160	108	145
G3412 TA ²	H	504	675	448	600	421	565	393	525	336	450	306	410	280	325
G3412 TA ¹	L	504	675	448	600	421	565	369	495	317	425	287	385	261	350
G3412 TA ²	H	448	600	399	535	373	500	347	465	298	400	272	365	250	335
G3412 TA ¹	H	504	675	448	600	421	565	392	525	336	450	306	410	280	375
G3412 TA ^{2,3}	H	475	637	—	—	—	—	—	—	—	—	—	—	—	—
G3412 TA ^{1,3}	H	504	675	—	—	—	—	—	—	—	—	—	—	—	—

NA — Naturally Aspirated

TA — Turbocharged-Aftercooled

H — High compression ratio

L — Low compression ratio

¹54°C/130°F or lower temperature water to the aftercooler.²32°C/90°F or lower temperature water to the aftercooler.³Low Emissions.**Rating Definition:**

Continuous: Output available without varying load for an unlimited time. Continuous power in accordance with ISO8528, ISO3046/1, AS2789, DIN6271, and BS5514.

Engine Model	Compression Ratio	1400 rpm		1200 rpm		1100 rpm		1000 rpm	
		bkW	bhp	bkW	bhp	bkW	bhp	bkW	bhp
G3508 NA	H			231	310	213	285	194	260
G3508 TA ^{2,3}	L			384	515	350	470	319	430
G3508 TA ²	H			392	525	362	485	328	440
G3508 TA ^{1,3}	L	500	670	407	545	373	500	336	450
3508 TA ²	H			407	545	373	500	336	450
G3512 NA	H			392	525	362	485	328	440
G3512 TA ¹	H			589	790	541	725	492	660
G3512 TA ²	H			608	815	556	745	504	675
G3512 TA ^{1,3}	L	705	945	604	810	556	745	504	675
G3512 TA ^{2,3}	L	750	1005	642	860	589	790	537	720
G3516 NA	H			492	660	466	625	436	585
G3516 TA ¹	H			783	1050	720	965	653	875
G3516 TA ²	H			809	1085	742	995	675	905
G3516 TA ^{1,3}	L	944	1265	809	1085	742	995	671	900
G3516 TA ^{2,3}	L	1000	1340	858	1150	783	1050	712	955

Engine Model	Compression Ratio	1000 rpm		900 rpm		800 rpm		700 rpm	
		bkW	bhp	bkW	bhp	bkW	bhp	bkW	bhp
G3606 ^{1,3}	L	1316	1765	1184	1588	1052	1410	984	1320
G3606 ^{2,3}	L	1242	1665	1119	1500	992	1330	928	1245
G3608 ^{1,3}	L	1754	2352	1579	2117	1402	1880	1312	1760
G3608 ^{2,3}	L	1659	2225	1491	2000	1324	1775	1242	1665
G3612 ^{1,3}	L	2632	3530	2368	3175	2107	2825	1976	2650
G3612 ^{2,3}	L	2487	3335	2237	3000	1987	2665	1864	2500
G3616 ^{1,3}	L	3509	4705	3158	4235	2808	3765	2632	3530
G3616 ^{2,3}	L	3320	4450	2984	4000	2652	3555	2632	3335

NA — Naturally Aspirated
TA — Turbocharged-Aftercooled
H — High compression ratio
L — Low compression ratio

¹54°C/130°F or lower temperature water to the aftercooler.
²32°C/90°F or lower temperature water to the aftercooler.
³Low Emissions.

Rating Definition:

Continuous: Output available without varying load for an unlimited time. Continuous power in accordance with ISO8528, ISO3046/1, AS2789, DIN6271, and BS5514.

50 Hz Diesel Gen Set Ratings

Gen Set Model	1500 rpm — With Fan		
	Standby kV•A	Prime kV•A	Continuous kV•A
3304 T	125	112	105
3208 T	175	150	145
3208 ATAAC	200	—	—
3306 TA	250	225	188
3306 ATAAC	275	250	206
3406 T	300	275	238
3406 TA	350	320	238
3406 TA	400	365	319
3408 TA	400	365	319
3412 T	500	455	369
3412 TT	550	500	319
3412 TA	600	545	432
3412 TA	650	600	444
3412 TA	700	635	500
3412 TA	750	680	549
3412 TA	800	725	575
3508 TA	1000	910	812
3508B	1100	1000	906
3512 TA	1250	1150	1000
3512 TA	1400	1275	1206
3512B	1500	1360	1320
3512B	1600	1500	—
3516 TA	1750	1600	1600
3516 TA	2000	1825	1600
3516B	2250	2000	1750
	1000 rpm		
3406 TA	—	188	—
3408 TA	—	256	—
3412 TA	—	350	—
3508 TA	525	500	488
3512 TA	812	750	700
3512 TA	950	856	838
3516 TA	950	875	689
3516 TA	1300	1169	1175

Gen Set Model	1000 rpm — Without Fan		
	Standby	Prime	Continuous
3606 TA	2690	2425	2200
3608 TA	3575	3250	2940
3612 TA	5375	4850	4400
3616 TA	7150	6500	5875
	750 rpm		
3606 TA	2160	1960	1775
3608 TA	2860	2600	2365
3612 TA	4325	3925	3550
3616 TA	5725	5200	4725

T — Turbocharged
 TA — Turbocharged-Aftercooled
 TT — Twin Turbochargers
 ATAAC — Air-to-air Aftercooled
 kV•A — Generator output

Rating Definitions:

Standby: Output available with varying load for the duration of the interruption of the normal source power.*

Prime: Output available with varying load for an unlimited time.**

Continuous: Output available without varying load for an unlimited time.***

*Fuel stop power in accordance with ISO3046/1, AS2789, DIN6271, and BS5514.

**Prime power in accordance with ISO8528, overload power in accordance with ISO3046/1, AS2789, DIN6271, and BS5514.

***Continuous power in accordance with ISO8528, ISO3046/1, AS2789, DIN6271, and BS5514.

60 Hz Diesel Gen Set Ratings

Gen Set Model	1800 rpm — With Fan		
	Standby ekW	Prime ekW	Continuous ekW
3304 T	125	113	100
3208 T	175	160	139
3208 ATAAC	200	—	—
3306 TA	230	210	—
3306 ATAAC	250	225	210
3406 TA	300	275	265
3406 TA	350	320	265
3406 TA	400	365	290
3408 TA	400	365	300
3412 T	500	455	360
3412 TA	550	500	400
3412 TA	600	545	435
3412 TA	650	591	473
3412 TA	700	635	500
3412 TA	750	680	540
3412 TA	800	725	575
3508 TA	900	820	660
3508B	1000	910	832
3512 TA	1000	910	890
3512 TA	1100	1000	890
3512 TA	1250	1135	1010
3512B	1400	1275	1230
3512B	1500	1360	—
3516 TA	1750	1600	1450
3516B	2000	1825	1640
	1200 rpm		
3406 TA	—	170	—
3408 TA	—	225	—
3412 TA	—	325	—
3508 TA	450	425	400
3512 TA	700	650	650
3512 TA	925	830	830
3516 TA	975	900	820
3516 TA	1250	1100	1020

Gen Set Model	900 rpm — Without Fan		
	Standby	Prime	Continuous
3606 TA	2000	1820	1650
3608 TA	2660	2420	2200
3612 TA	4000	3640	3300
3616 TA	5320	4840	4400
	720 rpm		
3606 TA	1680	1525	1375
3608 TA	2220	2020	1830
3612 TA	3360	3050	2750
3616 TA	4440	4040	3660

T — Turbocharged
 TA — Turbocharged-Aftercooled
 TT — Twin Turbochargers
 ATAAC — Air-to-air Aftercooled
 ekW — Generator output at 0.8 p.f.

Rating Definitions:

Standby: Output available with varying load for the duration of the interruption of the normal source power.*

Prime: Output available with varying load for an unlimited time.**

Continuous: Output available without varying load for an unlimited time.***

*Fuel stop power in accordance with ISO3046/1, AS2789, DIN6271, and BS5514.

**Prime power in accordance with ISO8528, overload power in accordance with ISO3046/1, AS2789, DIN6271, and BS5514.

***Continuous power in accordance with ISO8528, ISO3046/1, AS2789, DIN6271, and BS5514.

Olympian Generator Sets*

Gen Set Model	Prime		Standby	
	50 Hz (kV•A)	60 Hz ekW	50 Hz (kV•A)	60 Hz (ekW)
Gas				
CG012	6	6	12	12
CG015	10	10	15	15
CG020	15	15	20	20
CG025	20	20	25	25
CG030	20	20	30	30
CG035	25	25	35	35
CG040	30	30	40	40
CG050	40	40	50	50
CG070	50	50	70	70
CG085	70	70	80	80
CG100	90	90	100	100
CG125	110	110	125	125
Diesel				
CD008	6	6	8	8
CD010	8	8	10	10
CD012	10	10	12.5	12.5
CD015	12.5	12.5	15	15
CD017	15	15	17.5	17.5
CD020	15	15	20	20
CD025	20	20	25	25
CD030	25	25	30	30
CD035	30	30	35	35
CD040	45	36	50	40
CD050	50	45	55	50
CD060	59	54	65	60
CD075	67	68	75	75
CD080	79	72	88	80
CD100	100	90	110	100
CD125	100	100	125	125
CD150	135	135	150	150
CD175	160	160	175	175
CD200	180	180	200	200

*Olympian Generator Sets are manufactured exclusively for Caterpillar dealers by Generac Corporation.

kV•A — Generator output

ekW — Generator output at 0.8 p.f.

Gaseous-Fueled Generator Set Ratings

Gen Set Model	Continuous		Standby	Compression Ratio
	1500 rpm	1800 rpm	1800 rpm	
	Without Fan		Without Fan	
	50 Hz kV•A	60 Hz ekW	60 Hz ekW	
G3304-NA	45	55	—	L
G3304-NA	55	65	—	H
G3306-NA	70	85	—	L
G3306-NA	85	100	—	H
G3306-TA ²	110	135	—	L/H
G3306-TA ¹	125	140	—	L
G3306-TA ¹	125	150	—	L/H
G3406-NA	125	145	—	H
G3408-NA	155	175	—	H
G3306-NA	—	160	160	H
G3406-TA ²	175	210	255	H
G3406-TA ²	175	210	245	L
G3406-TA ¹	185	225	265	L
G3406-TA ¹	185	225	275	H
G3408-TA ²	210	255	300	L
G3408-TA ²	210	255	310	H
G3412-NA	225	250	—	H
G3408-TA ¹	230	280	325	L
G3408-TA ¹	230	280	340	H
G3412-TA ²	325	395	455	L
G3412-TA ²	325	395	480	H
G3412-TA ¹	350	425	495	L
G3412-TA ¹	355	425	515	H
G3508-TA ^{3,4}	455	—	—	L/H
G3508-TA ^{2,4}	480	—	—	L/H
G3508-TA ^{1,4}	505	—	—	L/H
G3512-TA ^{2,4}	725	—	—	L/H
G3512-TA ^{1,4}	765	—	—	L/H
G3516-TA ^{2,4}	975	—	—	L/H
G3516-TA ^{1,4}	1030	—	—	L/H
G3516-TA ^{2,4}	—	—	1040	H
G3516-TA ^{1,4}	—	—	1040	H

TA — Turbocharged-Aftercooled
 NA — Naturally Aspirated
 kV•A — Generator output
 ekW — Generator output at 0.8 p.f.
 H — High compression ratio
 L — Low compression ratio

¹32°C/90°F or lower water temperature to the aftercooler.
²54°C/130°F or lower water temperature to the aftercooler.
³70°C/160°F or lower water temperature to the aftercooler.
⁴Low emission.

Gaseous-Fueled Generator Set Ratings (cont'd)

Gen Set Model	Continuous		Standby	Compression Ratio
	1000 rpm	1200 rpm	1800 rpm	
	Without Fan		Without Fan	
	50 Hz kV•A	60 Hz ekW	60 Hz ekW	
G3508-NA	—	210	—	L
G3508-TA ²	—	370	—	L
G3508-TA ¹	—	380	—	L
G3508-TA ^{2,4}	—	375	—	L/H
G3508-TA ^{1,4}	—	400	—	L/H
G3512-NA	—	365	—	L
G3516-NA	—	460	—	L
G3512-TA ²	—	555	—	L
G3512-TA ¹	—	570	—	L
G3512-TA ^{2,4}	—	570	—	L/H
G3512-TA ^{1,4}	—	600	—	L/H
G3516-TA ²	—	750	—	L
G3516-TA ¹	—	770	—	L
G3516-TA ^{2,4}	—	770	—	L/H
G3516-TA ^{1,4}	—	820	—	L/H
	1000 rpm	900 rpm	1800 rpm	
G3606-TA ^{2,4}	1494	1075	—	L
G3606-TA ^{1,4}	1580	1135	—	L
G3608-TA ^{2,4}	1990	1430	—	L
G3608-TA ^{1,4}	2105	1515	—	L
G3612-TA ^{2,4}	3000	2160	—	L
G3612 ^{2,4}	3010	2180	—	H
G3612-TA ^{1,4}	3175	2285	—	L
G3612 ^{1,4}	3420	2475	—	H
G3616-TA ^{2,4}	3995	2880	—	L
G3516 ^{2,4}	4020	2900	—	H
G3616-TA ^{1,4}	4230	3050	—	L
G3516 ^{1,4}	4570	3285	—	H

TA — Turbocharged-Aftercooled

NA — Naturally Aspirated

kV•A — Generator output

ekW — Generator output at 0.8 p.f.

H — High compression ratio

L — Low compression ratio

¹32°C/90°F or lower water temperature to the aftercooler.²54°C/130°F or lower water temperature to the aftercooler.³70°C/160°F or lower water temperature to the aftercooler.⁴Low emission.

Cat Engines for Marine Propulsion Applications

Engine Model	A			B			C			D			E		
	kW	hp	rpm	kW	hp	rpm	kW	hp	rpm	kW	hp	rpm	kW	hp	rpm
3304 NA	63	85	2000	—	—	—	75	100	2200	—	—	—	—	—	—
3304 T	93	125	2000	104	140	2000	123	165	2200	134	180	2200	142	190	2200
3208 NA	112	150	2400	134	180	2400	157	210	2800	157	210	2800	157	210	2800
3306 T	142	190	2000	164	220	2000	186	250	2200	—	—	—	209	280	2200
3116 TA	153	205	2400	153	205	2400	190	255	2600	205	275	2600	224	300	2800
3116 TA	—	—	—	—	—	—	—	—	—	—	—	—	242	325	2800
3116 TA	172	230	2400	172	230	2400	209	280	2600	231	310	2600	261	350	2800
3126 TA	—	—	—	—	—	—	—	—	—	—	—	—	287	385	2800
3126 TA	—	—	—	—	—	—	—	—	—	—	—	—	313	420	2800
3208 T	160	215	2400	190	255	2400	216	290	2800	224	300	2800	239	320	2800
3208 TA	—	—	—	—	—	—	—	—	—	—	—	—	325	435	2800
3306 TA	160	215	2000	175	235	2000	201	270	2200	235	315	2200	261	350	2200
3306 SCAC	175	235	2000	186	250	2000	216	290	2200	250	335	2200	265	355	2200
3208 TA	175	235	2400	205	275	2400	235	315	2600	254	340	2800	280	375	2800
3406 T	186	250	1800	224	300	1800	260	348	2100	—	—	—	300	402	2100
3176B	—	—	—	—	—	—	336	450	2300	392	525	2300	448	600	2300
3406 TA	205	275	1200	231	310	1350	—	—	—	—	—	—	—	—	—
3406 TA	240	322	1800	283	380	1800	358	480	2100	399	535	2100	433	580	2100
3408 TA	261	350	1250	294	394	1350	—	—	—	—	—	—	—	—	—
3406E	—	—	—	298	400	1800	—	—	—	—	—	—	—	—	—
3406 TA	272	365	1800	328	440	2100	—	—	—	—	—	—	—	—	—
3196 TA	—	—	—	—	—	—	—	—	—	—	—	—	448	600	2300
3196	—	—	—	—	—	—	366	490	2300	425	570	2300	492	660	2300
3408 TA	280	375	1300	350	470	1800	—	—	—	—	—	—	—	—	—
3408 TA	300	402	1800	384	515	2100	403	540	2100	425	570	2100	436	585	2100
3412 TA	317	425	1200	354	475	1200	570	764	2100	—	—	—	—	—	—
3406E	336	450	1800	410	550	2100	448	600	2100	522	700	2200	597	800	2300
3408 TA	339	455	1800	—	—	—	—	—	—	—	—	—	—	—	—
3412 T	375	503	1800	403	540	1800	403	540	1800	—	—	—	—	—	—
3508 TA	447	600	1200	—	—	—	—	—	—	—	—	—	—	—	—
3412 T	448	600	1800	459	615	1800	474	635	1800	—	—	—	—	—	—
3412 TA	465	624	1800	500	671	1800	—	—	—	—	—	—	—	—	—
3412 TA	485	650	1800	537	720	1800	—	—	—	—	—	—	—	—	—
3508 TA	526	705	1200	600	805	1300	611	820	1300	—	—	—	—	—	—
3412 TTA	—	—	—	—	—	—	615	825	2100	671	900	2100	746	1000	2100
3508 TA	578	775	1600	—	—	—	—	—	—	—	—	—	—	—	—
3508 TA	578	775	1800	—	—	—	634	850	1800	—	—	—	—	—	—
3508B	578	775	1200	634	850	1200	671	900	1200	—	—	—	—	—	—

NA — Naturally Aspirated

SCAC — Separate Circuit Aftercooled

(Continued on next page)

T — Turbocharged

TTA — Twin Turbocharged-Aftercooled

TA — Turbocharged-Aftercooled

Rating Definitions: (except 3600s)

A: For use with little load cycling in oceangoing displacement hulls such as freighters, tugboats and bottomdrag trawlers, and deep river towboats.

B: For use in midwater trawlers, purse seiners, crew and supply boats, ferry boats with trips longer than one hour, and towboats in rivers where locks, sandbars, curves or traffic dictate frequent slowing.

C: For use in yachts with displacement hulls, as well as ferries with trips less than one hour, fish boats with higher speed journey out and back (e.g., some lobster, crayfish and tuna), and short trip coastal freighters.

D: For use in patrol, customs, police boats, and some fire boats. Also for bow/stern thrusters.

E: For use in pleasure craft with planing hulls, as well as for patrol, pilot and harbor master boats.

Cat Engines for Marine Propulsion Applications (cont'd)

Engine Model	A			B			C			D			E		
	kW	hp	rpm	kW	hp	rpm	kW	hp	rpm	kW	hp	rpm	kW	hp	rpm
3412 TA	—	—	—	—	—	—	634	850	2300	783	1050	2300	970	1300	2300
3412 TA	—	—	—	—	—	—	—	—	—	—	—	—	1007	1350	2300
3508 TA	638	855	1600	675	905	1600	701	940	1600	—	—	—	—	—	—
3508 TA	638	855	1800	716	960	1800	746	1000	1800	858	1500	1800	—	—	—
3508 EUI	638	855	1600	—	—	—	—	—	—	—	—	—	—	—	—
3508 EUI	638	855	1800	716	960	1800	746	1000	1800	858	1150	1800	—	—	—
3512 TA	671	900	1200	—	—	—	—	—	—	—	—	—	—	—	—
3512B	738	990	900	—	—	—	—	—	—	—	—	—	—	—	—
3508B	746	1000	1600	783	1050	1600	821	1100	1600	—	—	—	—	—	—
3508B	746	1000	1800	783	1050	1800	821	1100	1800	—	—	—	—	—	—
3512 TA	790	1060	1200	902	1210	1300	932	1250	1300	—	—	—	—	—	—
3508B	—	—	—	895	1200	1785	969	1300	1835	1044	1400	1880	1119	1500	1925
3512 TA	876	1175	1600	—	—	—	—	—	—	—	—	—	—	—	—
3512 TA	876	1175	1800	—	—	—	969	1300	1800	—	—	—	—	—	—
3516 TA	895	1200	1200	—	—	—	—	—	—	—	—	—	—	—	—
3512 TA	900	1200	1200	970	1300	1200	1060	1410	1200	—	—	—	—	—	—
3512 TA	954	1280	1600	1014	1360	1600	1051	1410	1600	—	—	—	—	—	—
3512 TA	954	1280	1800	1078	1445	1800	1119	1500	1800	1305	1750	1800	—	—	—
3512 EUI	954	1280	1600	—	—	—	—	—	—	—	—	—	—	—	—
3512 EUI	954	1280	1800	1078	1445	1800	1119	1500	1800	1305	1750	1800	—	—	—
3512B	970	1300	1200	1007	1350	1200	1100	1475	1200	—	—	—	—	—	—
3516B	984	1320	900	—	—	—	—	—	—	—	—	—	—	—	—
3516 TA	1051	1410	1200	1200	1610	1200	1242	1665	1200	—	—	—	—	—	—
3512B	1119	1500	1600	1175	1575	1600	1231	1650	1600	—	—	—	—	—	—
3512B	1119	1500	1800	1175	1575	1800	1231	1650	1800	—	—	—	—	—	—
3516 TA	1156	1550	1600	—	—	—	—	—	—	—	—	—	—	—	—
3516 TA	1156	1550	1800	—	—	—	1268	1700	1800	—	—	—	—	—	—
3516 TA	1195	1600	1200	1250	1675	1200	1305	1750	1200	—	—	—	—	—	—
3516B	1231	1650	1200	1305	1750	1200	1380	1850	1200	—	—	—	—	—	—
3512B	—	—	—	1343	1800	1785	1455	1950	1835	1567	2100	1880	1679	2250	1925
3516 TA	1275	1710	1600	1350	1810	1600	1398	1875	1600	—	—	—	—	—	—
3516 TA	1275	1710	1800	1432	1920	1800	1491	2000	1800	1641	2200	1800	—	—	—
3516 EUI	1275	1710	1600	—	—	—	—	—	—	—	—	—	—	—	—
3516 EUI	1275	1710	1800	1432	1920	1800	1491	2000	1800	1641	2200	1800	—	—	—
3516B	1491	2000	1600	1567	2100	1600	1641	2200	1600	—	—	—	—	—	—
3516B	1491	2000	1800	1567	2100	1800	1641	2200	1800	—	—	—	—	—	—
3516B	—	—	—	1790	2400	1785	1940	2600	1835	2088	2800	1880	2238	3000	1925

TA — Turbocharged-Aftercooled

Rating Definitions: (except 3600s)

A: For use with little load cycling in oceangoing displacement hulls such as freighters, tugboats and bottomdrag trawlers, and deep river towboats.

B: For use in midwater trawlers, purse seiners, crew and supply boats, ferry boats with trips longer than one hour, and towboats in rivers where locks, sandbars, curves or traffic dictate frequent slowing.

C: For use in yachts with displacement hulls, as well as ferries with trips less than one hour, fish boats with higher speed journey out and back (e.g., some lobster, crayfish and tuna), and short trip coastal freighters.

D: For use in patrol, customs, police boats, and some fire boats. Also for bow/stern thrusters.

E: For use in pleasure craft with planing hulls, as well as for patrol, pilot and harbor master boats.

Cat Engines for Marine Propulsion Applications

Engine Model	CS			MC		
	kW	hp	rpm	kW	hp	rpm
3606 TA	1490	2000	750	1640	2200	750
3606 TA	1560	2090	800	1720	2310	800
3606 TA	1730	2320	900	1900	2550	900
3606 TA	1850	2480	1000	2030	2720	1000
3608 TA	1980	2660	750	2180	2920	750
3608 TA	2080	2790	800	2290	3070	800
3608 TA	2300	3080	900	2530	3390	900
3608 TA	2460	3300	1000	2710	3630	1000
3612 TA	2980	4000	750	3280	4400	750
3612 TA	3120	4180	800	3440	4610	800
3612 TA	3460	4640	900	3800	5100	900
3612 TA	3700	4960	1000	4060	5440	1000
3616 TA	3960	5310	750	4360	5850	750
3616 TA	4160	5580	800	4580	6140	800
3616 TA	4600	6170	900	5060	6790	900
3616 TA	4920	6600	1000	5420	7270	1000

Engine Model	Fast commercial vessel rating			Military fast vessel rating		
	kW	hp	rpm	kW	hp	rpm
3612	4250	5700	1000	4500	6035	1000
3616	5650	7575	1000	6000	8050	1000
3618	7200	9655	1050	—	—	—

TA — Turbocharged-Aftercooled

RATING DEFINITIONS: (3600s)

CS: Continuous Service is suitable for continuous duty applications, including dredges, for operation without interruption or load cycling.

MC: Maximum Continuous is generally used for vessel applications involving varying loads. The engine power actually produced is limited by application guidelines, leaving a power reserve for unusual operating conditions.

Engine Model	50 Hertz			60 Hertz*			
	1500 rpm kV•A	1000 rpm kV•A	750 rpm kV•A	1800 rpm ekW	1200 rpm ekW	900 rpm ekW	720 rpm ekW
3304 NA	63	—	—	65	—	—	—
3304 T	106	—	—	105	—	—	—
3306 T	150, 194	—	—	170	—	—	—
3306 T	181, 200	—	—	175	—	—	—
3306 TA	—	—	—	190	—	—	—
3306 TA	—	—	—	195	—	—	—
3406 T	250	—	—	250	—	—	—
3406 T	269	—	—	260	—	—	—
3406 TA	300	—	—	315	—	—	—
3406 TA	306	188	—	320	190	—	—
3408 TA	—	238	—	—	245	—	—
3408 TA	388	—	—	370	—	—	—
3412 T	481	—	—	400	—	—	—
3412 T	438, 506	—	—	425	—	—	—
3412 TA	600	—	—	550	—	—	—
3412 TA	575, 625	—	—	500, 590	310	—	—
3508 TA	631, 788	500	—	560, 715	450	—	—
3508B	906, 1000	—	—	910	—	—	—
3512 TA	950, 1206	913, 1019	—	850, 1070	750, 910	—	—
3512B	1363, 1500	—	—	1275, 1360	—	—	—
3516 TA	1281, 1606	1188, 1300	—	1135, 1440	1000, 1170	—	—
3516B	1825, 2000	—	—	1825	—	—	—
3606 TA**	—	2425	1963	—	—	1820	1525
3608 TA**	—	3250	2600	—	—	2420	2020
3612 TA**	—	4850	3925	—	—	3640	3050
3616 TA**	—	6500	5200	—	—	4840	4040

*@ .8 power factor.

**Cat does not manufacture a generator for these engine models.

ekW and kV•A are assumed using generators ranging in efficiency from 95.4 to 97.0.

NA — Naturally Aspirated

T — Turbocharged

TA — Turbocharged-Aftercooled

Rating Definition:

For continuous electrical service with 10% overload capability for one hour in 12 in accordance with ISO 3046/1, DIN 6271, BS 5514.

Engine Model	Heat Exchanger Cooled			Radiator Cooled		
	kW	hp	rpm	kW	hp	rpm
3304 NA	54	72	1200	—	—	—
3304 NA	59	79	1500	57	76	1500
3304 NA	77	104	1800	73	98	1800
3306B T	78, 96	105, 130	1200	—	—	—
3304 T	96	129	1500	94	126	1500
3304 T	118	158	1800	116	156	1800
3306B T	156, 171	209, 229	1500	130, 154, 169	174, 206, 227	1500
3406C TA	167	224	1000	—	—	—
3306B T	190	255	1800	183	245	1800
3406C TA	208	279	1200	—	—	—
3408C TA	208	279	1000	—	—	—
3306B TA	210	281	1800	206	276	1800
3406C T	229	307	1500	229	307	1500
3406C TA	260	348	1500	260	349	1500
3408C TA	266	357	1200	—	—	—
3406C T	228, 277	306, 371	1800	277	371	1800
3412C TA	336	451	1200	—	—	—
3408C TA	340	456	1500	340	456	1500
3406C TA	345	462	1800	345	462	1800
3408C TA	410	549	1800	410	555	1800
3412C T	431	578	1500	431	578	1500
3412C T	450	603	1800	450	603	1800
3412C TA	487, 534	653, 716	1500	534	716	1500
3412C TA	536, 620	719, 831	1800	620	831	1800

NA — Naturally Aspirated
T — Turbocharged
TA — Turbocharged-Aftercooled

Engines

Truck Diesel

- 3126 ● C-10
- C-12 ● 3306C
- 3406C

Diesel Engine Model	kW	Rating hp	rpm	Peak Torque			Torque Rise (%)	Weight	
				N•m	lb-ft	rpm		kg	lb
3126									
ATAAC	131	175	2500	571	420	1440	25%	568	1250
ATAAC	152	190	2500	707	520	1440	40%	568	1250
ATAAC	157	210	2500	707	520	1440	23%	568	1250
ATAAC	157	210	2400	823	605	1440	45%	568	1250
ATAAC	172	230	2400	898	660	1440	37%	568	1250
ATAAC	187	250	2400	898	660	1440	26%	568	1250
ATAAC	187	250	2400	1088	800	1440	52%	568	1250
ATAAC	205	275	2400	1088	800	1440	39%	568	1250
ATAAC	205	275	2400	1170	860	1440	49%	568	1250
ATAAC	224	300	2400	1088	800	1440	27%	568	1250
ATAAC	224	300	2400	1170	860	1440	37%	568	1250
ATAAC	246	330	2400	1170	860	1440	19%	568	1250
C-10									
ATAAC	227	305	2100	1424	1050	1200	34%	932	2050
ATAAC	227	305	1800	1550	1150	1200	29%	932	2050
ATAAC	227	305	1800	1550	1150	1200	51%	932	2050
ATAAC	250	335	1800	1695	1250	1200	28%	932	2050
ATAAC	250	335	2100	1695	1250	1200	49%	932	2050
ATAAC	250	335	1800	1830	1350	1200	38%	932	2050
ATAAC	261	350	1800	1830	1350	1200	32%	932	2050
ATAAC	261	350	1800	1830	1350	1200	54%	932	2050
ATAAC	276	370	1800	1830	1350	1200	25%	932	2050
ATAAC	250/276	335/370*	1800	1695/1830	1250/1350	1200	28/25%	932	2050
ATAAC	209	280	2100	1322	975	1200	39%	932	2050
C-12									
ATAAC	250	335	2100	2108	1550	1200	85%	940	2070
ATAAC	264	355	1800	1830	1350	1200	30%	940	2070
ATAAC	264/306	355*/410	1800	1830/2108	1350/1550	1200	30/21%	940	2070
ATAAC	264/306	355*/410	1800	1830/1972	1350/1450	1200	31%	940	2070
ATAAC	283	380	1800	1972	1450	1200	21%	940	2070
ATAAC	306	410	1800	1972	1450	1200	53%	940	2070
ATAAC	283/306	380*/410	1800	1972/2108	1450/1550	1200	31/30%	940	2070
ATAAC	283/321	380/430	1800	1972/2108	1450/1650	1200	31/53%	940	2070
ATAAC	306	410	2100	2108	1550	1200	51%	940	2070
ATAAC	317	425**	2100	1972	1450	1200	41%	940	2070
ATAAC	317	425**	2100	2108	1550	1200	51%	940	2070
ATAAC	321	430	1800	2244	1650	1200	32%	940	2070
ATAAC	321	430	2100	2244	1650	1200	53%	940	2070
ATAAC	339	455	2100	2108	1550	1200	36%	940	2070
3306C									
ATAAC	224	300	1900	1496	1150	1200	46%	896	1975
3406C***									
ATAAC	261	350	1800	1830	1450	1200	42%	1328	2926
ATAAC	317	425	1900	2244	1650	1200	40%	1328	2926

*Multi-Torque.

**Firetruck/RV rating.

***49-State and Canada.

ATAAC — Air-to-Air Aftercooled

Diesel Engine Model	kW	Rating hp	rpm	Peak Torque			Torque Rise (%)	Weight	
				N•m	lb-ft	rpm		kg	lb
3406E									
ATAAC	261	350	1800	1972	1450	1200	42%	1301	2867
ATAAC	264	355	1800	1836	1350	1200	30%	1301	2867
ATAAC	264	355	2100	1836	1350	1200	52%	1301	2867
ATAAC	264	355	1800	1836/1972	1350/1450	1200	40%	1301	2867
ATAAC	280	375	1800	1972	1450	1200	33%	1301	2867
ATAAC	280	375	2100	1972	1450	1200	55%	1301	2867
ATAAC	280	375	1800	1972/2108	1450/1550	1200	42%	1301	2867
ATAAC	280/324	375/435	1800	1972/2108	1450/1550	1200	33/22%	1301	2867
ATAAC	280/324	375/435*	1800	1972/2244	1450/1650	1200	33/30%	1301	2867
ATAAC	317	425	1900	2244	1650	1200	40%	1301	2867
ATAAC	324	435	1800	2108	1550	1200	22%	1301	2867
ATAAC	324	435	2100	2108	1550	1200	42%	1301	2867
ATAAC	324	435	1800	2244	1650	1200	30%	1301	2867
ATAAC	324	435	2100	2244	1650	1200	52%	1301	2867
ATAAC	339	455	1800	2244	1650	1200	24%	1301	2867
ATAAC	339	455	2100	2244	1650	1200	45%	1301	2867
ATAAC	354	475	1800	2244	1650	1200	19%	1301	2867
ATAAC	354	475	2100	2244	1650	1200	39%	1301	2867
ATAAC	354/373	475/500	2100	2244/2516	1650/1850	1200	19/27%	1301	2867
ATAAC	354	475	1800	2380	1750	1200	26%	1301	2867
ATAAC	354	475	2100	2380	1750	1200	47%	1301	2867
ATAAC	373	500	2100	2244	1650	1200	32%	1301	2867
ATAAC	373	500	2100	2380	1750	1200	47%	1301	2867
ATAAC	373	500	1800	2516	1850	1200	27%	1301	2867
ATAAC	373	500	2100	2516	1850	1200	48%	1301	2867
ATAAC	410	550	2100	2516	1850	1200	41%	1301	2867

*Multi-Torque.
ATAAC — Air-to-Air Aftercooled

FORMER MODELS



TRACK-TYPE TRACTORS

Model	Product Ident. No. Prefix	Years Built	Horse-power FW/ Drawbar	Approx. Machine Weight kg (lb)	Gauge m (ft) and Width m (ft)	Length m (ft) and Height m (ft)	Transmission	Rated Drawbar Pull — kg (lb) and Forward Speed — km/h (mph)				
								1st	2nd	3rd	4th	5th
D2	4U	47-58	43/38	3258 (7175)	1.02 (3'4") 1.42 (4'8")	2.74 (9'0") 1.57 (5'2")	DD	3609 (7950)	2588 (5700)	2061 (4540)	1634 (3600)	1067 (2350)
D2	4U	47-58	42/35	3258 (7175)	1.02 (3'4") 1.57 (5'2")	2.74 (9'0") 1.57 (5'2")	DD	3609 (7950)	2588 (5700)	2061 (4540)	1634 (3600)	1067 (2350)
D2	5U	57-58	38/32	3119 (5870)	1.27 (4'2") 1.42 (4'8")	2.74 (9'0") 1.57 (5'2")	DD	3033 (6680)	2483 (5420)	2007 (4420)	1703 (3570)	1035 (2280)
D2	5U	57-58	43/38	3373 (7430)	1.27 (4'2") 1.67 (5'6")	2.74 (9'0") 1.57 (5'2")	DD	3609 (7950)	2588 (5700)	2061 (4540)	1634 (3600)	1067 (2250)
D3	79U	72-79	62/—	4812 (10,610)	1.42 (4'8") 1.78 (5'10")	2.77 (9'1") 1.70 (5'7")	PS					
D3 LGP	6N	72-79	62/—	5410 (11,925)	1.65 (5'5") 2.29 (7'6")	2.97 (9'10") 1.70 (5'7")	PS					
D3B	23Y	79-87	65	6719 (14,812)	1.42 (4'8") 1.78 (5'10")	2.77 (9'1") 2.67 (8'9")	PS					
D3B	27Y	79-87	65	6877 (15,160)	1.42 (4'8") 1.78 (5'10")	2.77 (9'1") 2.67 (8'9")	PS					
D3B LGP	24Y	79-87	65	7479 (16,488)	1.65 (5'5") 2.29 (7'6")	2.99 (9'10") 2.67 (8'9")	PS					
D3B LGP	28Y	79-87	65	7637 (16,836)	1.65 (5'5") 2.29 (7'6")	2.99 (9'10") 2.67 (8'9")	PS					
D3B	3YC	85-87	65	6719 (14,812)	1.42 (4'8") 1.78 (5'10")	2.77 (9'1") 2.67 (8'9")	DD					
D3B LGP	5MC	85-87	65	7479 (16,488)	1.65 (5'5") 2.29 (7'6")	2.99 (9'10") 2.67 (8'9")	DD					

NOTE: Power Shift models show speeds only, not drawbar pull.
NOTE: Track-Type Tractor weights do not include blades until 1967.

Track-Type Tractors (cont'd)

Model	Product Ident. No. Prefix	Years Built	Horse-power FW/ Drawbar	Approx. Machine Weight kg (lb)	Gauge m (ft) and Width m (ft)	Length m (ft) and Height m (ft)	Transmission	Rated Drawbar Pull — kg (lb) and Forward Speed — km/h (mph)					
								1st	2nd	3rd	4th	5th	6th
D3C	5KG	87-90	67	7084 (15,618)	1.42 (4'8") 1.79 (5'10.6")	2.8 (9'4") 2.66 (8'8.9")	PS	3.1 (1.9)	5.9 (3.7)	10.8 (6.7)			
D3C Series II		90-93	70	7001 (15,435)	1.42 (4'8") 1.79 (5'11")		PS	3.1 (1.9)	5.9 (3.7)	10.8 (6.7)			
D3C XL Series II		91-93	70	7242 (15,965)	1.42 (4'8") 1.83 (6'0")		PS	3.1 (1.9)	5.9 (3.7)	10.8 (6.7)			
D3C LGP	1PJ	87-90	67	7788 (17,170)	1.65 (5'4") 2.29 (7'6")	3.0 (9'10.1") 2.66 (8'8.9")	PS	3.1 (1.9)	5.9 (3.7)	10.8 (6.7)			
D3C LGP Series II		90-93	70	7788 (17,170)	1.65 (5'5") 2.29 (7'6")		PS	3.1 (1.9)	5.9 (3.7)	10.8 (6.7)			
D4	6U	47-59	48/43	4629 (10,195)	1.12 (3'8") 1.58 (5'2")	3.07 (11'0") 1.54 (5'1")	DD	4531 (9980)	3496 (7700)	2656 (5850)	2089 (4600)	1339 (2950)	
D4	6U	47-59	60/48	4847 (10,675)	1.12 (3'8") 1.58 (5'2")	3.16 (10'5") 1.54 (5'1")	DD	4858 (10,700)	3496 (7700)	2724 (6000)	2093 (4610)	1326 (2920)	
D4	6U	47-59	63/50	4844 (10,675)	1.12 (3'8") 1.58 (5'2")	3.18 (10'5") 1.76 (5'10")	DD	4858 (10,700)	3528 (7770)	2724 (6000)	2093 (4610)	1326 (2920)	
D4	7U	47-59	63/50	5067 (10,970)	1.52 (5'0") 1.98 (6'6")	3.16 (10'5") 1.76 (5'10")	DD	4858 (10,700)	3528 (7770)	2724 (6000)	2093 (4610)	1326 (2920)	
D4B	2XF	87	75	7450 (16,420)	1.42 (4'8") 1.78 (5'10")	2.78 (9'1") 2.67 (8'9")	PS	3.2 (2.0)	6.0 (3.7)	11.1 (6.9)			
D4B LGP	1SG	87	75	7800 (17,200)	1.65 (5'5") 2.29 (7'6")	2.99 (9'10") 2.67 (8'9")	PS	3.2 (2.0)	6.0 (3.7)	11.1 (6.9)			
D4C	39A	59-63	65/52	5064 (11,155)	1.12 (3'8") 1.58 (5'2")	3.05 (10'1") 1.76 (5'10")	DD	4858 (10,700)	3528 (7770)	2724 (6000)	2093 (4610)	1321 (2910)	

NOTE: Power Shift models show speeds only, not drawbar pull.
 NOTE: Track-Type Tractor weights do not include blades until 1967.

Track-Type Tractors (cont'd)

Model	Product Ident. No. Prefix	Years Built	Horse-power FW/ Drawbar	Approx. Machine Weight kg (lb)	Gauge m (ft) and Width m (ft)	Length m (ft) and Height m (ft)	Transmission	Rated Drawbar Pull — kg (lb) and Forward Speed — km/h (mph)					
								1st	2nd	3rd	4th	5th	6th
D4C	40A	59-63	65/52	4881 (10,750)	1.52 (5'0") 1.98 (6'6")	3.05 (10'1") 1.76 (5'10")	DD	4858 (10,700)	3528 (7770)	2724 (6000)	2093 (4610)	1321 (2910)	
D4C	1RJ	87-90	78	7581 (16,714)	1.42 (4'7") 1.83 (6'0")	3.00 (9'10.1") 2.66 (8'8.9")	PS		3.1 (1.9)	4.3 (2.7)	5.5 (3.4)	6.8 (4.2)	9.8 (6.1)
D4C Series II		90-93	80	7557 (16,660)	1.42 (4'8") 1.83 (6'5")		PS		3.1 (1.9)	5.9 (3.7)	11.1 (6.9)		
D4C LGP	2CJ	87-90	78	7905 (17,427)	1.65 (5'4") 2.29 (7'6")	3.00 (9'10.1") 2.66 (8'8.9")	PS						
D4C LGP Series II		90-93	80	7905 (17,427)	1.65 (5'5") 2.29 (7'6")		PS		3.2 (2.0)	5.9 (3.7)	11.1 (6.9)		
D4D	78A	63-68	65/52	5900 (13,000)	1.52 (5'0") 1.98 (6'6")	3.35 (11'0") 2.41 (7'11")	DD	5300 (11,690)	3700 (8160)	2560 (5640)	1880 (4150)	1350 (2980)	
D4D	22C	67-68	65/—	5900 (13,100)	1.52 (5'0") 1.98 (6'6")	3.38 (11'1") 2.41 (7'11")	PS		2.7 (1.7)	3.9 (2.4)	5.5 (3.4)	7.1 (4.4)	9.3 (5.8)
D4D	82J	63	—/65	7910 (17,440)	1.52 (5'0") 1.98 (6'6")	3.38 (11'1") 2.67 (8'9")	DD	6150 (13,550)	4150 (9140)	2820 (6210)	2030 (4480)	1420 (3120)	
D4D	83J	67-71	—/65	8270 (18,240)	1.52 (5'0") 1.98 (6'6")	3.38 (11'1") 2.67 (8'9")	PS		2.7 (1.7)	4.0 (2.5)	5.4 (3.4)	7.2 (4.5)	9.4 (5.9)
D4D	83J	72-77	—/75	5900 (13,100)	1.52 (5'0") 1.98 (6'6")	3.38 (11'1") 2.67 (8'9")	DD	6150 (13,550)	4150 (9140)	2820 (6210)	2030 (4480)	1420 (3120)	
D4E	27X	77-84	80/—	9013 (19,820)	1.52 (5'0") 2.44 (8'0")	3.86 (12'8") 2.72 (8'11")	DD	6495 (14,320)	4425 (9756)	3018 (6654)	2172 (4788)	1509 (3327)	
D4E	28X	77-84	80/—	9090 (20,040)	1.52 (5'0") 2.44 (8'0")	3.86 (12'8") 2.72 (8'11")	PS		2.8 (1.7)	4.0 (2.5)	5.5 (3.4)	7.2 (4.5)	9.5 (5.9)
								3.3 (2.1)	5.9 (3.7)	9.5 (5.9)			

NOTE: Power Shift models show speeds only, not drawbar pull.

NOTE: Track-Type Tractor weights do not include blades until 1967.

Track-Type Tractors (cont'd)

Model	Product Ident. No. Prefix	Years Built	Horse-power FW/ Drawbar	Approx. Machine Weight kg (lb)	Gauge m (ft) and Width m (ft)	Length m (ft) and Height m (ft)	Transmission	Rated Drawbar Pull — kg (lb) and Forward Speed — km/h (mph)						
								1st	2nd	3rd	4th	5th	6th	
D4H (JPN)	8PB*	85-89	90/—	9975 (21,991)	1.67 (5'6") 2.13 (7'0")	3.422 (11'3") 2.933 (9'8")	PS	3.5 (2.2)	6.2 (3.9)	10.2 (6.3)				
D4H (JPN)	2AC*	85-89	90/—	10 111 (22,291)	1.67 (5'6") 2.13 (7'0")	3.422 (11'3") 2.933 (9'8")	DD	7618 (16,798)	5843 (12,884)	4333 (9554)	3207 (7071)	2335 (5149)	1640 (3617)	
D4H (JPN)	8PB*	89-90	95/—	10 105 (22,277)	1.67 (5'6") 2.13 (7'0")	3.422 (11'3") 2.933 (9'8")	PS	3.5 (2.2)	6.2 (3.9)	10.2 (6.3)				
D4H (JPN)	8PB	91-96	95/—	11 019 (24,242)	1.67 (5'6") 2.13 (7'0")	3.44 (11'3") 2.939 (9'8")	PS	3.5 (2.2)	6.2 (3.9)	10.2 (6.3)				
D4H (JPN)	2AC*	89-90	95/—	10 231 (22,555)	1.67 (5'6") 2.13 (7'0")	3.422 (11'3") 2.933 (9'8")	DD	7454 (16,434)	5715 (12,599)	4235 (9336)	3132 (6904)	2277 (5020)	1597 (3520)	
D4H (JPN)	2AC	91-96	95/—	11 019 (24,242)	1.67 (5'6") 2.13 (7'0")	3.44 (11'3") 2.939 (9'8")	DD	7454 (16,434)	5715 (12,599)	4235 (9336)	3132 (6904)	2227 (5020)	1597 (3520)	
D4H LGP (JPN)	9DB*	85-89	90/—	11 245 (24,790)	2.00 (6'7") 2.76 (9'1")	3.693 (10'4") 2.986 (9'10")	PS	3.5 (2.2)	6.2 (3.9)	10.2 (6.3)				
D4H LGP (JPN)	3AC*	85-89	90/—	11 381 (25,090)	2.00 (6'7") 2.76 (9'1")	3.693 (10'4") 2.986 (9'10")	DD	7618 (16,798)	5843 (12,884)	4333 (9554)	3207 (7071)	2335 (5149)	1640 (3617)	
D4H LGP (JPN)	9DB*	89-90	95/—	11 350 (25,022)	2.00 (6'7") 2.76 (9'1")	3.693 (10'4") 2.986 (9'10")	PS	3.5 (2.2)	6.2 (3.9)	10.2 (6.3)				
D4H LGP (JPN)	9DB	91-96	105/—	12 440 (27,368)	2.00 (6'7") 2.76 (9'1")	3.718 (12'2") 3.04 (10'0")	PS	3.4 (2.1)	6.0 (3.7)	10.2 (6.4)				
D4H LGP (JPN)	3AC*	89-90	95/—	11 476 (25,300)	2.00 (6'7") 2.76 (9'1")	3.693 (10'4") 2.986 (9'10")	DD	7454 (16,434)	5715 (12,599)	4235 (9336)	3132 (6904)	2277 (5020)	1597 (3520)	
D4H LGP (JPN)	9GJ	92-96	105/—	12 440 (27,368)	2.00 (6'7") 2.76 (9'1")	3.718 (12'2") 3.04 (10'0")	PS	3.4 (2.1)	6.0 (3.7)	10.2 (6.4)				
D4H XL (JPN)	8PS	92-96	105/—	11 786 (25,929)	1.77 (5'10") 2.28 (7'6")	3.446 (11'4") 2.99 (9'10")	PS	3.4 (2.1)	6.0 (3.7)	10.2 (6.4)				

*D4H models prior to Series II. Product identification number prefix still in use for current product.

NOTE: Power Shift models show speeds only, not drawbar pull.

NOTE: Track-Type Tractor weights do not include blades until 1967.

Track-Type Tractors (cont'd)

Model	Product Ident. No. Prefix	Years Built	Horse-power FW/ Drawbar	Approx. Machine Weight kg (lb)	Gauge m (ft) and Width m (ft)	Length m (ft) and Height m (ft)	Transmission	Rated Drawbar Pull — kg (lb) and Forward Speed — km/h (mph)					
								1st	2nd	3rd	4th	5th	6th
D5	81H	67-67	93/75	8300 (18,200)	1.52 (5'0") 2.02 (6'8")	3.89 (12'9") 2.00 (8'7")	DD	7870 (17,330)	4910 (10,820)	3330 (7320)	2230 (4920)	1440 (3170)	
D5	82H	67-67	93/75	8400 (18,600)	1.88 (6'2") 2.38 (7'10")	3.89 (12'9") 2.00 (8'7")	DD	7870 (17,330)	4910 (10,820)	3330 (7320)	2230 (4920)	1440 (3170)	
D5	83H	67-67	93/—	8500 (18,800)	1.52 (5'0") 2.02 (6'8")	3.89 (12'9") 2.64 (8'8")	PS						
D5	84H	67-67	93/—	8700 (19,200)	1.88 (6'2") 2.38 (7'10")	3.89 (12'9") 2.64 (8'8")	PS						
D5	98J	67-77	105	11 290 (24,400)	1.52 (5'0") 2.02 (6'8")	3.89 (12'9") 2.74 (9'0")	DD	8770 (19,340)	5500 (12,130)	3750 (8270)	2540 (5610)	1660 (3660)	9.0 (5.6)
D5	93J	67-77	105	11 290 (24,400)	1.52 (5'0") 2.02 (6'8")	3.89 (12'9") 2.74 (9'0")	DD	8770 (19,340)	5500 (12,130)	3750 (8270)	2540 (5610)	1660 (3660)	
D5	94J	66-77	105	11 390 (25,100)	1.88 (6'2") 2.38 (7'10")	3.89 (12'9") 2.74 (9'0")	DD	8770 (19,340)	5500 (12,130)	3750 (8270)	2540 (5610)	1660 (3660)	
D5	95J	66-77	105	11 290 (24,900)	1.52 (5'0") 2.02 (6'8")	3.89 (12'9") 2.74 (9'0")	PS						
D5	96J	66-77	105	11 600 (25,600)	1.88 (6'2") 2.38 (7'10")	3.89 (12'9") 2.74 (9'0")	PS						
D5B	25X	77-84	105/—	11 619 (25,615)	1.88 (6'2") 3.15 (10'4")	4.60 (15'1") 2.77 (9'1")	PS						
D5B	23X	77-82	105/—	11 283 (24,875)	1.88 (6'2") 3.15 (10'4")	4.60 (15'1") 2.77 (9'1")	DD	8060 (17,770)	5030 (11,100)	3410 (7520)	2290 (5060)	1480 (3260)	
D5C		91-93	90	8460 (18,650)	1.54 (5'1") 2.01 (6'7")		PS						
D5C LGP		91-93	90	8987 (19,800)	1.72 (5'8") 2.38 (7'10")		PS						

NOTE: Power Shift models show speeds only, not drawbar pull.
NOTE: Track-Type Tractor weights do not include blades until 1967.

Track-Type Tractors (cont'd)

Model	Product Ident. No. Prefix	Years Built	Horse-power FW/ Drawbar	Approx. Machine Weight kg (lb)	Gauge m (ft) and Width m (ft)	Length m (ft) and Height m (ft)	Transmission	Rated Drawbar Pull — kg (lb) and Forward Speed — km/h (mph)						
								1st	2nd	3rd	4th	5th	6th	
D5H (FR)	8RC*	85-90	120/—	12 144 (26,772)	1.8 (5'11") 2.21 (7'3")	3.6 (11'10") 2.93 (9'7")	PS	— 3.3 (2.1)	— 5.9 (3.7)	— 10.0 (6.2)				
D5H (FR)	8RC	91-96	120/—	13 250 (29,200)	1.8 (5'11") 2.31 (7'7")	3.6 (11'10") 3.0 (9'10")	DD		3.3 (2.1)	5.9 (3.7)	10.0 (6.2)			
D5H (FR)	7NC*	85-90	120/—	12 212 (26,922)	1.8 (5'11") 2.21 (7'3")	3.6 (11'10") 2.93 (9'7")	DD	9140 (20,150)	7005 (15,440)	5190 (11,440)	3835 (8450)	2785 (6140)	1950 (4300)	
D5H (FR)	7NC	91-96	120/—	13 250 (29,200)	1.8 (5'11") 2.31 (7'7")	3.6 (11'10") 3.0 (9'10")	DD	9140 (20,150)	7005 (15,440)	5190 (11,440)	3835 (8450)	2785 (6140)	1950 (4300)	
D5H LGP (FR)	1DD*	86-90	120/—	14 685 (32,380)	2.16 (7'1") 3.02 (9'11")	4.129 (13'7") 3.069 (10'1")	PS		3.3 (2.1)	5.9 (3.7)	10.0 (6.2)			
D5H LGP (FR)	1DD	91-96	130/—	16 200 (35,700)	2.16 (7'1") 3.02 (9'11")	4.133 (13'7") 3.135 (10'3")	PS		3.3 (2.1)	5.9 (3.7)	10.0 (6.2)			
D5H LGP (FR)	9HC*	85-90	120/—	14 878 (32,800)	2.16 (7'1") 3.02 (9'11")	4.129 (13'7") 3.069 (10'1")	DD	9140 (20,150)	7005 (15,440)	5190 (11,440)	3835 (8450)	2785 (6140)	1950 (4300)	
D5H LGP (FR)	9HC	91-96	130/—	16 200 (35,700)	2.16 (7'1") 3.02 (9'11")	4.133 (13'7") 3.135 (10'3")	DD	10 061 (22,181)	7725 (17,031)	5738 (12,650)	4256 (9384)	3109 (6855)	2195 (4840)	
D5H (JPN)	3MD*	86-90	120/—	12 144 (26,772)	1.8 (5'11") 2.21 (7'3")	3.6 (11'10") 2.93 (9'7")	PS		3.3 (2.1)	5.9 (3.7)	10.0 (6.2)			
D5H (JPN)	3MD	91-96	120/—	13 250 (29,200)	1.8 (5'11") 2.31 (7'7")	3.6 (11'10") 3.0 (9'10")	PS		3.3 (2.1)	5.9 (3.7)	10.0 (6.2)			
D5H (JPN)	1YD*	86-90	120/—	12 212 (26,922)	1.8 (5'11") 2.21 (7'3")	3.6 (11'10") 2.93 (9'7")	DD	9140 (20,150)	7005 (15,440)	5190 (11,440)	3835 (8450)	2785 (6140)	1950 (4300)	
D5H (JPN)	1YD*	91-96	120/—	13 250 (29,200)	1.8 (5'11") 2.31 (7'7")	3.6 (11'10") 3.0 (9'10")	DD	9140 (20,150)	7005 (15,440)	5190 (11,440)	3835 (8450)	2785 (6140)	1950 (4300)	

*D5H models prior to Series II. Product identification number prefix still in use for current product.

NOTE: Power Shift models show speeds only, not drawbar pull.

NOTE: Track-Type Tractor weights do not include blades until 1967.

Track-Type Tractors (cont'd)

Model	Product Ident. No. Prefix	Years Built	Horse-power FW/ Drawbar	Approx. Machine Weight kg (lb)	Gauge m (ft) and Width m (ft)	Length m (ft) and Height m (ft)	Transmission	Rated Drawbar Pull — kg (lb) and Forward Speed — km/h (mph)						
								1st	2nd	3rd	4th	5th	6th	
D5H LGP (JPN)	4KD*	86-90	120/—	14 685 (32,380)	2.16 (7'1") 3.02 (9'11")	4.129 (13'7") 4.133 (10'4")	PS	3.3 (2.1)	5.9 (3.6)	10.0 (6.2)				
D5H LGP (JPN)	4KD	91-96	130/—	16 200 (35,700)	2.16 (7'1") 3.02 (9'11")	4.133 (13'7") 3.135 (10'3")	PS	3.3 (2.1)	5.9 (3.7)	10.0 (6.2)				
D5H LGP (JPN)	2SD*	86-90	120/—	14 878 (32,800)	2.16 (7'1") 3.02 (9'11")	4.129 (13'7") 3.069 (10'4")	DD	9140 (20,150)	7005 (15,440)	5190 (11,440)	3835 (8450)	2785 (6140)	1950 (4300)	
D5H LGP (JPN)	2SD	91-96	130/—	16 200 (35,700)	2.16 (7'1") 3.02 (9'11")	4.133 (13'7") 3.135 (10'3")	DD	10 061 (22,181)	7725 (17,031)	5738 (12,650)	4256 (9384)	3109 (6855)	2195 (4840)	
D5H XL (FR)	8RJ	92-96	130/—	13 900 (30,600)	1.89 (6'2") 2.49 (8'2")	3.606 (11'10") 3.08 (9'11")	PS	3.3 (2.1)	5.9 (3.7)	10.0 (6.2)				
D6	4R	47-59	85	8042 (17,730)	1.88 (6'2") 1.52 (5'0")	3.75 (12'4") 1.91 (6'3")	DD	8618 (19,000)	5534 (12,200)	3837 (8460)	2617 (5770)	1842 (4060)		
D6	9U	47-59	93/75	8153 (17,975)	1.88 (6'2") 1.52 (5'0")	3.75 (12'4") 1.91 (6'3")	DD	8618 (19,000)	5534 (12,200)	3837 (8460)	2617 (5770)	1842 (4060)		
D6B	37A	59-67	93/75	8130 (17,930)	1.52 (5'0") 2.02 (6'8")	3.85 (12'9") 1.91 (6'3")	DD							
D6B	44A	59-67	93/75	8300 (18,300)	1.88 (6'2") 2.38 (7'10")	3.85 (12'9") 1.91 (6'3")	DD	7820 (16,240)	4940 (10,900)	3220 (7090)	2120 (4670)	1450 (3190)		
D6C	74A	63-67	120	10 400 (23,000)	1.88 (6'2") 2.38 (7'9")	3.95 (13'0") 1.92 (6'4")	DD	12 050 (26,540)	8020 (17,670)	5300 (11,690)	3360 (7400)	2030 (4470)		
D6C	76A	63-67	120	10 700 (23,500)	1.88 (6'2") 2.38 (7'9")	3.95 (13'0") 1.92 (6'4")	PS							
D6C	10K	67-76	140	13 880 (30,600)	1.88 (6'2") 2.38 (7'9")	3.73 (12'3") 2.87 (9'5")	PS	4.0 (2.5)	6.9 (4.3)	10.8 (6.7)				

*D5H models prior to Series II. Product identification number prefix still in use for current product.

NOTE: Power Shift models show speeds only, not drawbar pull.

NOTE: Track-Type Tractor weights do not include blades until 1967.

Track-Type Tractors (cont'd)

Model	Product Ident. No. Prefix	Years Built	Horse-power FW/ Drawbar	Approx. Machine Weight kg (lb)	Gauge m (ft) and Width m (ft)	Length m (ft) and Height m (ft)	Transmission	Rated Drawbar Pull — kg (lb) and Forward Speed — km/h (mph)						
								1st	2nd	3rd	4th	5th	6th	
D6 LGP	69U	72-77	140	17 010 (37,500)	2.11 (6'11") 3.02 (9'11")	3.94 (12'11") 2.97 (9'9")	PS							
D6C	99J	67-76	140	14 243 (31,400)	1.88 (6'2") 2.38 (7'9")	3.73 (12'3") 2.87 (9'5")	DD	11 500 (25,360)	7750 (17,090)	5180 (11,420)	3350 (7380)	2090 (4610)		
D6C LGP	69U	72-77	140	13 835 (30,500)	2.11 (6'11") 3.02 (9'11")	2.97 (9'9") 3.94 (12'11")	PS							
D6D	3X	77-86	140	14 290 (31,500)	1.88 (6'2") 2.36 (7'9")	3.73 (12'3") 3.06 (10'0")	DD	11 500 (25,360)	7750 (17,090)	5180 (11,420)	3350 (7380)	2090 (4610)		
D6D	4X	77-86	140	14 290 (31,500)	1.88 (6'2")	3.73 (12'3")	PS	4.0 (2.5)	6.9 (4.3)	10.8 (6.7)				
D6D LGP	6X	77-86	140	17 370 (38,300)	2.1 (6'11") 3.02 (9'11")	3.94 (12'1") 3.06 (10'0")	PS	4.0 (2.5)	6.9 (4.3)	10.8 (6.7)				
D6H	4RC*	85-90	165/—	16 950 (37,367)	1.88 (6'2") 2.64 (8'8")	4.069 (13'4") 3.114 (10'3")	PS	3.8 (2.4)	6.5 (4.0)	11.3 (7.0)				
D6H	8KB	85-88	165/—	16 954 (37,377)	1.88 (6'2") 2.64 (8'8")	4.069 (13'4") 3.114 (10'3")	DD	12 500 (27,560)	9520 (20,990)	7140 (15,740)	5440 (11,990)	4010 (8840)	2820 (6220)	
D6H	3ZF*	88-90	165/—	17 055 (37,599)	1.88 (6'2") 2.64 (8'8")	4.069 (13'4") 3.114 (10'3")	PS/DS	3.8 (2.4)	6.5 (4.0)	11.3 (7.0)				
D6H LGP	6FC*	87-90	165/—	19 555 (43,111)	2.225 (7'4") 3.43 (11'3")	4.493 (14'9") 3.164 (10'5")	PS	3.8 (2.4)	6.5 (4.0)	11.3 (7.0)				
D6H LGP	3YG*	88-90	165/—	19 527 (43,049)	2.225 (7'4") 3.43 (11'3")	4.493 (14'9") 3.164 (10'5")	PS/DS	3.8 (2.4)	6.5 (4.0)	11.3 (7.0)				
D6H (JPN)	2KD*	86-90	165/—	16 950 (37,367)	1.88 (6'2") 2.64 (8'8")	4.069 (13'4") 3.114 (10'3")	PS	3.8 (2.4)	6.5 (4.0)	11.3 (7.0)				

*D6H models prior to Series II. Product identification number prefix still in use for current product.

NOTE: Power Shift models show speeds only, not drawbar pull.

NOTE: Track-Type Tractor weights do not include blades until 1967.

Track-Type Tractors (cont'd)

Model	Product Ident. No. Prefix	Years Built	Horse-power FW/ Drawbar	Approx. Machine Weight kg (lb)	Gauge m (ft) and Width m (ft)	Length m (ft) and Height m (ft)	Transmission	Rated Drawbar Pull — kg (lb) and Forward Speed — km/h (mph)					
								1st	2nd	3rd	4th	5th	6th
D6H (DS)	32F	92-96	123/165	18 111 (39,928)	1.88	4.07	PS	3.8 (2.3)	6.6 (4.1)	11.4 (7.1)			
	(E. Peoria) 4YF				3.36	3.12							
	(Sagami) 6CF (Grenoble)				11'0"	10'3"							
D6H (CB)	4RC	92-96	123/165	17 997 (39,676)	1.88	4.07	PS	3.8 (2.3)	6.6 (4.1)	11.4 (7.1)			
	(E. Peoria) 2KD				3.36	3.12							
	(Sagami) 4LG (Grenoble)				11'0"	10'3"							
D6H XL (DS)	9KJ	92-96	130/175	19 080 (42,063)	1.88	4.07	PS	3.8 (2.3)	6.6 (4.1)	11.4 (7.1)			
	(E. Peoria) 8SK				3.36	3.12							
	(Sagami) 9LK (Grenoble)				11'0"	10'3"							
D6H XL (CB)	8ZJ	92-96	130/175	18 966 (41,811)	1.88	4.07	PS	3.8 (2.3)	6.6 (4.1)	11.4 (7.1)			
	(E. Peoria) 9RK				3.36	3.12							
	(Sagami) 8KK (Grenoble)				11'0"	10'3"							
D6H XR (DS)	6CK	92-96	130/175	18 799 (41,444)	1.88	4.22	PS	3.8 (2.3)	6.6 (4.1)	11.4 (7.1)			
	(E. Peoria) 2TL				3.36	3.12							
	(Sagami) 1YL (Grenoble)				11'0"	10'3"							
D6H XR (CB)	5KK	92-96	130/175	18 799 (41,444)	1.88	4.22	PS	3.8 (2.3)	6.6 (4.1)	11.4 (7.1)			
	(E. Peoria) 7ZK				3.36	3.12							
	(Sagami) 2BL (Grenoble)				11'0"	10'3"							
D6H LGP (DS)	3YG	92-96	134/180	20 486 (45,163)	2.24	4.49	PS	3.8 (2.3)	6.6 (4.1)	11.4 (7.1)			
	(E. Peoria) 4GG				4.0	3.17							
	(Sagami) 5HF (Grenoble)				13'1"	10'5"							
D6H LGP (CB)	6FC	92-96	134/180	20 486 (45,163)	2.24	4.49	PS	3.8 (2.3)	6.6 (4.1)	11.4 (7.1)			
	(E. Peoria) 1KD				4.0	3.17							
	(Sagami) 2TG (Grenoble)				13'1"	10'5"							

NOTE: Power Shift models show speeds only, not drawbar pull.

NOTE: Track-Type Tractor weights do not include blades until 1967.

Track-Type Tractors (cont'd)

Model	Product Ident. No. Prefix	Years Built	Horse-power FW/ Drawbar	Approx. Machine Weight kg (lb)	Gauge m (ft) and Width m (ft)	Length m (ft) and Height m (ft)	Transmission	Rated Drawbar Pull — kg (lb) and Forward Speed — km/h (mph)					
								1st	2nd	3rd	4th	5th	6th
D6H (JPN)	3ED*	86-92	165/—	16 954 (37,377)	1.88 (6'2") 2.64 (8'8")	4.069 (13'4") 3.114 (10'3")	DD	12 500 (27,560)	9520 (20,990)	7140 (15,740)	5440 (11,990)	4010 (8840)	2820 (6220)
D6H (JPN)	4YF*	88-90	165/—	17 055 (37,599)	1.88 (6'2") 2.64 (8'8")	4.069 (13'4") 3.114 (10'3")	PS/DS	3.8 (2.4)	6.5 (4.0)	11.3 (7.0)			
D6H LGP (JPN)	1KD*	86-90	165/—	19 555 (43,111)	2.225 (7'4") 3.43 (11'3")	4.493 (14'9") 3.164 (10'5")	PS	3.8 (2.4)	6.5 (4.0)	11.3 (7.0)			
D6H LGP (JPN)	8FC*	86-90	165/—	19 676 (43,380)	2.225 (7'4") 3.43 (11'3")	4.485 (14'9") 3.164 (10'5")	DD	12 500 (27,560)	9520 (20,990)	7140 (15,740)	5440 (11,990)	4010 (8840)	2820 (6220)
D6H LGP (JPN)	4GG*	88-90	165/—	19 527 (43,049)	2.225 (7'4") 3.43 (11'3")	4.493 (14'9") 3.164 (10'5")	PS/DS	3.8 (2.4)	6.5 (4.0)	11.3 (7.0)			
D6H (FR)	4LG*	87-90	165/—	16 950 (37,367)	1.88 (6'2") 2.64 (8'8")	4.069 (13'4") 3.114 (10'3")	PS	3.8 (2.4)	6.5 (4.0)	11.3 (7.0)			
D6H (FR)	1FJ*	88-90	165/—	16 954 (37,377)	1.88 (6'2") 2.64 (8'8")	4.069 (13'4") 3.114 (10'3")	DD	12 500 (27,560)	9520 (20,990)	7140 (15,740)	5440 (11,990)	4010 (8840)	2820 (6220)
D6H (FR)	6CF*	88-90	165/—	17 055 (37,599)	1.88 (6'2") 2.64 (8'8")	4.069 (13'4") 3.114 (10'3")	PS/DS	3.8 (2.4)	6.5 (4.0)	11.3 (7.0)			
D6H LGP (FR)	2TG*	87-90	165/—	19 555 (43,111)	2.225 (7'4") 3.43 (11'3")	4.493 (14'9") 3.164 (10'5")	PS	3.8 (2.4)	6.5 (4.0)	11.3 (7.0)			
D6H LGP (FR)	5HF*	88-90	165/—	19 527 (43,049)	2.225 (7'4") 3.43 (11'3")	4.493 (14'9") 3.164 (10'5")	PS/DS	3.8 (2.4)	6.5 (4.0)	11.3 (7.0)			
D6H (SCOT)	7PC	86-87	165/—	16 950 (37,367)	1.88 (6'2") 2.64 (8'8")	4.069 (13'4") 3.114 (10'3")	PS	3.8 (2.4)	6.5 (4.0)	11.3 (7.0)			
D6H LGP (SCOT)	8YC	86-87	165/—	19 555 (43,111)	2.225 (7'4") 3.43 (11'3")	4.493 (14'9") 3.164 (10'5")	PS	3.8 (2.4)	6.5 (4.0)	11.3 (7.0)			

*D6H models prior to Series II. Product identification number prefix still in use for current product.

NOTE: Power Shift models show speeds only, not drawbar pull.

NOTE: Track-Type Tractor weights do not include blades until 1967.

Track-Type Tractors (cont'd)

Model	Product Ident. No. Prefix	Years Built	Horse-power FW/ Drawbar	Approx. Machine Weight kg (lb)	Gauge m (ft) and Width m (ft)	Length m (ft) and Height m (ft)	Transmission	Rated Drawbar Pull — kg (lb) and Forward Speed — km/h (mph)						
								1st	2nd	3rd	4th	5th	6th	
D7	3T	54-55	108/90	11 770 (25,925)	1.88 (6'2") 2.64 (8'1")	4.27 (14'0") 2.06 (6'10")	DD							
D7C	17A	55-59	128/102	11 954 (26,355)	1.88 (6'2") 2.64 (8'1")	4.26 (14'0") 2.06 (6'10")	DD	11 759 (25,900)	8045 (17,720)	4521 (11,960)	3428 (7550)	2397 (5280)		
D7D	17A	59-61	140/112	12 056 (26,555)	1.88 (6'2") 2.64 (8'1")	4.26 (14'0") 2.06 (6'10")	DD	12 300 (27,100)	8600 (18,900)	5700 (12,550)	3650 (8080)	2600 (5720)		
D7E	47A	61-68	160/128	14 787 (32,590)	1.98 (6'6") 2.56 (8'5")	4.47 (14'8") 2.30 (7'7")	DD	14 741 (32,500)	10 296 (22,700)	6803 (15,000)	4259 (9390)	3070 (6770)		
D7E	48A	61-66	160/128	14 787 (32,590)	1.98 (6'6") 2.56 (8'5")	4.47 (14'8") 2.30 (7'7")	PS							
D7E	47A	66-69	180/144	15 200 (33,500)	1.98 (6'6") 2.56 (8'5")	4.47 (14'8") 2.18 (7'2")	DD	17 140 (37,750)	11 350 (25,000)	7420 (16,340)	4540 (9990)	3180 (7010)		
D7E	48A	66-69	180	15 500 (34,000)	1.98 (6'6") 2.56 (8'5")	4.47 (14'8") 2.18 (7'2")	PS							
D7F	94N	69-74	180	14 700 (32,400)	1.98 (6'6") 2.56 (8'5")	4.15 (13'8") 2.26 (7'5")	PS							
D7F	93N	69-74	180	14 700 (32,400)	1.98 (6'6") 2.56 (8'5")	4.15 (13'8") 2.26 (7'5")	DD	17 100 (37,600)	11 350 (25,000)	7450 (16,400)	4580 (10,000)	3240 (7140)		
D7G	92V	77-86	200	20 090 (44,300)	1.98 (6'6") 2.62 (8'7")	4.19 (13'9") 3.35 (11'0")	PS	3.7 (2.3)	6.4 (4.0)	10.0 (6.2)				
D7G	91V	77-86	200	20 090 (44,300)	1.98 (6'6") 2.62 (8'7")	4.19 (13'9") 3.35 (11'0")	DD	17 690 (39,010)	11 730 (25,860)	7680 (16,940)	4700 (10,370)	3320 (7320)		
D7G LGP	72W	77-86	200	22 630 (52,100)	2.18 (7'2") 3.3 (10'11")	4.22 (13'9") 3.28 (10'9")	PS	3.7 (2.3)	6.4 (4.0)	10.0 (6.2)				

*D7H models prior to Series II. Product identification number prefix still in use for current product.

NOTE: Power Shift models show speeds only, not drawbar pull.

NOTE: Track-Type Tractor weights do not include blades until 1967.

Track-Type Tractors (cont'd)

Model	Product Ident. No. Prefix	Years Built	Horse-power FW/ Drawbar	Approx. Machine Weight kg (lb)	Gauge m (ft) and Width m (ft)	Length m (ft) and Height m (ft)	Transmission	Rated Drawbar Pull — kg (lb) and Forward Speed — km/h (mph)					
								1st	2nd	3rd	4th	5th	6th
D7H (CB)	79Z (E. Peoria) 4AB (Sagami)	92-96	171/230	24 778 (54,635)	1.98 (6'6")	4.74 (15'6")	PS	3.5 (2.2)	6.2 (3.8)	10.6 (6.6)			
					3.9 (12'10")	3.5 (11'6")							
D7H (DS)	5BF (E. Peoria) 2RG (Sagami)	92-96	171/230	25 077 (55,295)	1.98 (6'6")	4.74 (15'6")	PS	3.5 (2.2)	6.2 (3.8)	10.6 (6.6)			
					3.9 (12'10")	3.5 (11'6")							
D7H LGP (CB)	80Z (E. Peoria) 5WB (Sagami)	92-96	171/230	27 065 (59,678)	2.24 (7'4")	4.74 (15'6")	PS	3.5 (2.2)	6.2 (3.8)	10.6 (6.6)			
					4.50 (14'9")	3.58 (11'9")							
D7H LGP (DS)	4FG (E. Peoria) 3XG (Sagami)	92-96	171/230	27 065 (59,678)	2.24 (7'4")	4.74 (15'6")	PS	3.5 (2.2)	6.2 (3.8)	10.6 (6.6)			
					4.50 (14'9")	3.58 (11'9")							
D7H XR (CB)	79Z (E. Peoria) 4AB (Sagami)	92-96	171/230	25 193 (55,551)	1.98 (6'6")	4.74 (15'6")	PS	3.5 (2.2)	6.2 (3.8)	10.6 (6.6)			
					3.9 (12'10")	3.5 (11'6")							
D7H XR (DS)	5BF (E. Peoria) 2RG (Sagami)	92-96	171/230	25 492 (56,211)	1.98 (6'6")	4.74 (15'6")	PS	3.5 (2.2)	6.2 (3.8)	10.6 (6.6)			
					3.9 (12'10")	3.5 (11'6")							
D7H	77Z	85-86	215	19 680 (43,380)	1.98 (6'6")	4.73 (15'6")	DD	16 834 (37,113)	12 861 (28,353)	9703 (21,390)	7436 (16,394)	5522 (12,173)	3940 (8686)
D7H (US)	79Z*	85-90	215/—	23 647 (52,134)	1.981 (6'6")	4.619 (15'2")	PS	2.7 (1.7)	3.5 (2.2)	4.5 (2.8)	5.8 (3.6)	7.6 (4.7)	10.0 (6.2)
					2.54 (8'5")	3.421 (11'3")		6.8 (4.2)	11.9 (7.4)				
D7H (US)	77Z	85-90	215/—	23 570 (51,960)	1.981 (6'6")	4.619 (15'2")	DD	16 834 (37,113)	12 861 (28,353)	9703 (21,390)	7436 (16,394)	5522 (12,173)	3940 (8686)
					2.869 (9'5")	3.421 (11'3")		2.7 (1.7)	3.5 (2.2)	4.6 (2.8)	5.8 (3.6)	7.6 (4.7)	10.0 (6.2)

*D7H models prior to Series II. Product identification number prefix still in use for current product.

NOTE: Power Shift models show speeds only, not drawbar pull.

NOTE: Track-Type Tractor weights do not include blades until 1967.

Track-Type Tractors (cont'd)

Model	Product Ident. No. Prefix	Years Built	Horse-power FW/ Drawbar	Approx. Machine Weight kg (lb)	Gauge m (ft) and Width m (ft)	Length m (ft) and Height m (ft)	Transmission	Rated Drawbar Pull — kg (lb) and Forward Speed — km/h (mph)						
								1st	2nd	3rd	4th	5th	6th	
D7H (US)	5BF*	88-90	215/—	24 351 (53,683)	1.981 (6'6") 2.871 (9'5")	4.624 (15'2") 3.429 (11'3")	PS/DS	3.7 (2.3)	6.4 (4.0)	11.1 (6.9)				
D7H LGP (US)	80Z*	85-90	215/—	25 237 (55,638)	2.235 (7'4") 3.371 (11'1")	4.619 (15'2") 3.503 (11'6")	PS	3.9 (2.4)	6.8 (4.2)	11.9 (7.4)				
D7H LGP (US)	4FG*	87-90	230/—	25 894 (57,086)	2.235 (7'4") 3.377 (11'1")	4.624 (15'2") 3.505 (11'6")	PS/DS	3.7 (2.3)	6.4 (4.0)	11.1 (6.9)				
D7H (JPN)	4AB*	86-90	215/—	23 647 (52,134)	1.981 (6'6") 2.869 (9'5")	4.619 (15'2") 3.421 (11'3")	PS	3.9 (2.4)	6.8 (4.2)	11.9 (7.4)				
D7H (JPN)	2SB*	86-91	215/—	23 570 (51,960)	1.981 (6'6") 2.869 (9'5")	4.619 (15'2") 3.421 (11'3")	DD	16 834 (37,113)	12 861 (28,353)	9703 (21,390)	7436 (16,394)	5522 (12,173)	3940 (8686)	
D7H (JPN)	2RG*	88-90	215/—	24 351 (53,683)	1.981 (6'6") 2.871 (9'5")	4.624 (15'2") 3.429 (11'3")	PS/DS	3.7 (2.3)	6.4 (4.0)	11.1 (6.9)				
D7H LGP (JPN)	5WB*	86-90	215/—	25 237 (55,638)	2.235 (7'4") 3.371 (11'1")	4.619 (15'2") 3.503 (11'6")	PS	3.9 (2.4)	6.8 (4.2)	11.9 (7.4)				
D7H LGP (JPN)	82Z*	86-91	215/—	25 445 (56,096)	2.235 (7'4") 3.371 (11'1")	4.619 (15'2") 3.503 (11'6")	DD	16 834 (37,113)	12 861 (28,353)	9703 (21,390)	7436 (16,394)	5522 (12,173)	3940 (8686)	
D7H LGP (JPN)	3XG*	88-90	230/—	25 894 (57,086)	2.235 (7'4") 3.377 (11'1")	4.624 (15'2") 3.505 (11'6")	PS/DS	3.7 (2.3)	6.4 (4.0)	11.1 (6.9)				

*D7H models prior to Series II. Product identification number prefix still in use for current product.

NOTE: Power Shift models show speeds only, not drawbar pull.

NOTE: Track-Type Tractor weights do not include blades until 1967.

Track-Type Tractors (cont'd)

Model	Product Ident. No. Prefix	Years Built	Horse-power FW/ Drawbar	Approx. Machine Weight kg (lb)	Gauge m (ft) and Width m (ft)	Length m (ft) and Height m (ft)	Transmission	Rated Drawbar Pull — kg (lb) and Forward Speed — km/h (mph)						Remarks
								1st	2nd	3rd	4th	5th	6th	
D8	1H	35-41	110/95	14 790 (32,600)	1.98 (6'6") 2.64 (8'8")	4.64 (15'3") 2.28 (7'6")	*	9680 (21,350)	6870 (15,150)	5720 (12,610)	4800 (10,590)	3860 (8520)	2740 (6050)	RD-8 with 78" gauge
								2.7 (1.7)	3.8 (2.4)	4.5 (2.8)	5.1 (3.2)	6.3 (3.9)	8.5 (5.3)	
D8	8R	41-45	131/113	15 490 (34,160)	1.98 (6'6") 2.64 (8'8")	4.64 (15'3") 1.85 (6'1")	**	13 060 (28,800)	9750 (21,500)	7940 (17,500)	6800 (15,000)	5620 (12,400)	3990 (8800)	Horsepower Increase
								2.5 (1.6)	3.5 (2.2)	4.2 (2.6)	4.8 (3.0)	5.8 (3.6)	7.9 (4.9)	
D8	2U	45-53	148/130	16 470 (36,310)	1.98 (6'6") 2.64 (8'8")	4.85 (15'10") 2.18 (7'2")	DD	13 560 (29,900)	9840 (21,700)	7120 (15,700)	5400 (11,900)	3900 (8600)		HP increase, DD transmission
								2.5 (1.6)	3.7 (2.3)	4.6 (2.9)	5.9 (3.7)	7.7 (4.8)		
D8	13A	53-55	185/150	16 866 (37,150)	1.98 (6'6") 2.64 (8'8")	4.88 (16'1") 2.18 (7'2")	DD	20 358 (44,840)	12 939 (28,500)	8926 (19,660)	6955 (15,320)	4935 (10,870)		
D8D, G	15A	55-57	191/155	16 310 (35,925)	1.98 (6'6") 2.58 (8'6")	5.23 (17'2") 2.23 (7'8")	TC							
								5.8 (3.6)	8.5 (5.3)	11.9 (7.4)				
D8E, F	14A	55-57	191/155 Belt	17 734 (39,060)	1.98 (6'6") 2.64 (8'8")	4.88 (16'1") 2.26 (7'6")	DD	20 439 (45,020)	16 135 (35,540)	10 964 (24,150)	7373 (16,240)	4953 (10,910)		
								2.4 (1.5)	3.1 (1.9)	4.5 (2.8)	6.1 (3.8)	8.3 (5.2)		
D8H	35A	59-61	235	20 924 (46,032)	2.13 (7'0") 2.87 (9'1")	5.20 (17'1") 2.39 (7'10")	TC							
								5.6 (3.5)	8.2 (5.1)	12.2 (7.6)				
D8H	36A	58-66	235/185	21 400 (47,180)	2.13 (7'0") 2.87 (9'1")	5.20 (17'1") 2.39 (7'10")	DD	19 958 (44,400)	15 648 (34,500)	10 931 (24,100)	8051 (17,750)	5869 (13,000)	3832 (8450)	
								2.4 (1.5)	3.0 (1.9)	4.3 (2.7)	5.6 (3.5)	7.4 (4.6)	10.1 (6.3)	
D8H	46A	58-74	270	21 863 (48,210)	2.13 (7'0") 2.87 (9'1")	5.20 (17'1") 2.39 (7'10")	PS							
								3.8 (2.4)	6.7 (4.2)	10.4 (6.5)				
D8K	76V	74-82	300	31 980 (69,300)†	2.13 (7'0") 3.05 (10'0")	5.26 (17'3") 2.44 (8'0")	DD	25 400 (56,000)	18 930 (41,740)	12 990 (28,640)	9370 (20,650)	6610 (14,580)	4090 (9010)	Turbocharged, Sealed and Lubricated Track
								2.7 (1.7)	3.5 (2.2)	4.8 (3.0)	6.3 (3.9)	8.2 (5.1)	11.3 (7.0)	
D8K	77V	74-82	300	31 430 (70,500)*	2.13 (7'0") 3.05 (10'0")	5.26 (17'3") 2.44 (8'0")	PS							Turbocharged, Sealed and Lubricated Track
								4.0 (2.5)	7.1 (4.4)	10.9 (6.8)				
D8L	53Y 7JC 7YB	82-86 84-90 85-92	335	37 305 (82,243)	2.2 (7'3") 2.84 (9'4")	4.95 (16'2") 3.79 (12'5")	PS							
								3.9 (2.4)	6.8 (4.2)	11.9 (7.4)				
D8L SA	4FB	84-87	400/325	36 650 (80,820)	2.54 (8'4") 3.11 (10'3")		DD	31 679 (69,840)	23 115 (50,960)	17 196 (37,910)	12 388 (27,310)	9154 (20,180)	6428 (14,170)	
								2.9 (1.8)	3.9 (2.4)	5.0 (3.1)	6.8 (4.2)	8.9 (5.5)	11.9 (7.4)	

* Power transmitted through dry tape flywheel clutch to selective type hinge speed gear set.

** Power transmitted through flexible and over center engagement, dry flywheel clutch with metallic friction surfaces. Selective type change speed gear set.

† Approximate operating weight. Includes lubricants, coolant, full fuel tank, hydraulic control, 8S Bulldozer, ROPS canopy and operator.

All other weights listed in this column are shipping weights.

NOTE: Power Shift models show speeds only, not drawbar pull.

NOTE: Track-Type Tractor weights do not include blades until 1967.

Track-Type Tractors (cont'd)

Model	Product Ident. No. Prefix	Years Built	Horse-power FW/ Drawbar	Approx. Machine Weight kg (lb)	Gauge m (ft) and Width m (ft)	Length m (ft) and Height m (ft)	Transmission	Rated Drawbar Pull — kg (lb) and Forward Speed — km/h (mph)						Remarks
								1st	2nd	3rd	4th	5th	6th	
D8N	9TC 5TJ	87-92 92-95	285 285	37 462 (82,590)	2.08 (6'10") 3.05 (10'0")	4.95 (16'3") 3.43 (11'3")	PS	4						Turbocharged, Sealed and Lubricated Track
D9D	18A	55-56	286/230	25 772 (56,765)	2.29 (7'6") 3.03 (10'0")	5.46 (17'11") 2.67 (8'9")	DD	27 631 (60,860)	21 207 (46,710)	15 423 (33,970)	10 706 (23,580)	7658 (16,670)	4958 (10,920)	
D9D	18A	56-59	320/260	26 125 (57,543)	2.29 (7'6") 3.03 (10'0")	5.46 (17'11") 2.67 (8'9")	DD	28 603 (63,000)	23 835 (52,500)	16 617 (36,600)	12 167 (26,800)	9171 (20,200)	6106 (13,450)	
D9D	19A	55-56	286/230	25 729 (56,670)	2.29 (7'6") 3.03 (10'0")	5.46 (17'11") 2.67 (8'9")	TC	6.6 (4.1)	9.0 (5.6)	12.6 (7.8)				
D9D	19A	56-59	320/260	26 238 (57,990)	2.29 (7'6") 3.03 (10'0")	5.46 (17'11") 2.68 (8'9")	TC	6.6 (4.1)	9.5 (5.9)	13.0 (8.1)				
D9E	50A	59-60	335	27 016 (59,506)	2.29 (7'6") 3.03 (10'0")	5.50 (18'1") 2.70 (8'11")	TC	6.8 (4.2)	9.7 (6.0)	13.2 (8.2)				
D9D	34A	59-61	335	27 167 (59,837)	2.29 (7'6") 3.03 (10'0")	5.50 (18'1") 2.70 (8'11")	PS	4.2 (2.6)	7.2 (4.5)	11.2 (7.0)				
D9E	49A	59-60	335/268	26 957 (59,375)	2.29 (7'6") 3.03 (10'0")	5.50 (18'1") 2.70 (8'11")	DD	2.7 (1.7)	3.5 (2.2)	4.8 (3.0)	6.4 (4.0)	8.2 (5.1)	11.4 (7.1)	
D9G	66A	61-74	385	31 072 (68,500)	2.29 (7'6") 3.10 (10'0")	5.50 (18'1") 2.10 (8'7")	PS	3.9 (2.4)	6.8 (4.2)	10.5 (6.5)				

NOTE: Power Shift models show speeds only, not drawbar pull.

NOTE: Track-Type Tractor weights do not include blades until 1967.

Track-Type Tractors (cont'd)

Model	Product Ident. No. Prefix	Years Built	Horse-power FW/ Drawbar	Approx. Machine Weight kg (lb)	Gauge m (ft) and Width m (ft)	Length m (ft) and Height m (ft)	Transmission	Rated Drawbar Pull — kg (lb) and Forward Speed — km/h (mph)						Remarks
								1st	2nd	3rd	4th	5th	6th	
S × S D9G	29N	69-74	770	86 200* (190,000)	5.8* (19'0")	8.0◀ (25'0")	PS	3.9 (2.4)	6.8 (4.2)	10.0 (6.2)	L.H. of S × S D9G			
	7.3** (24'0")				2.8◀◀ (9'2")	R.H. of S × S D9G								
Dual D9G	90J	69-74	770	79 470* (175,200)	2.3* (7'6")	12.9◀ (42'6")	PS	3.9 (2.4)	6.8 (4.2)	10.5 (6.5)	Front of Dual D9G			
	3.3** (10'9")				3.1◀◀ (9'11")	Rear of Dual D9G								
S × S D9H	99V	74-77	820	83 400* (183,900)	5.8* (19'0")	9.0◀ (26'1")	PS	4.0 (2.5)	6.9 (4.3)	10.8 (6.7)	L.H. of S × S D9H			
	7.3** (24'0")				2.9◀◀ (9'6")	R.H. of S × S D9H								
Dual D9H	97V	74-80	820	81 100* (178,800)	2.3* (7'6")	12.9◀ (42'6")	PS	4.0 (2.5)	6.9 (4.3)	10.8 (6.7)	Front of Dual D9H			
	3.3** (10'9")				3.1◀◀ (9'11")	Rear of Dual D9H								
D9H	90V	74-81	410	32 840 (72,400)	2.3* (7'6")	5.6 (18'5")	PS	4.0 (2.5)	6.9 (4.3)	10.8 (6.7)	Standard Model			
					3.0 (9'11")	2.7◀◀ (8'10")								
D9L	14Y	80-87	460	52 055 (114,656)	2.5 (8'2")	5.32 (17'5")	PS	3.9 (2.4)	7.2 (4.5)	12.4 (7.7)				
					3.11 (10'2")	4.41 (14'6")								
D9N	1JD	86-94	370	42 816 (96,196)	2.55 (7'5")	5.17 (16'11.5")	PS	3.9 (2.4)	6.9 (4.3)	12.1 (7.5)				
	6XJ	93-95			2.43 (9'7")	3.91 (12'10")								
D10	84W	78-86	700	79 619 (175,526)	2.89 (9'6")	5.92 (19'8")	PS	3.9 (2.4)	6.9 (4.3)	11.9 (7.4)				
	76X													3.61 (11'11.5")
D10N	2YD	87-93	520	66 400 (147,405)	2.55 (8'4")	5.89 (18'4")	PS	4.0 (2.5)	7.1 (4.4)	12.5 (7.7)				
	3SK	93-96			3.30 (10'10")	4.45 (14'7")								
D11N	74Z	86-93	770	97 454 (214,847)	2.90 (9'6")	6.16 (20'3")	PS	3.9 (2.4)	6.8 (4.4)	11.6 (7.2)				
	4HK	93-96			3.65 (12'0")	4.56 (14'11")								
D11R	8ZR	96-97	770	98 413 (216,963)	2.90 (9'6")	6.16 (20'3")	PS	3.9 (2.4)	6.8 (4.4)	11.6 (7.2)	Electronic Finger Tip Control Steering			
					3.60 (11'10")	4.67 (15'3")								

* Gauge of both tractors combined.

**Width to outside of dozer blade.

* Approximate weight of both machines plus Bulldozer, hydraulic controls, coolant and 5% fuel.

NOTE: Power Shift models show speeds only, not drawbar pull.

NOTE: Track-Type Tractor weights do not include blades until 1967.

◀ Length including dozer blade.

◀◀ Overall height excluding stack and canopy.

TRACK-TYPE TRACTORS MANUFACTURED OUTSIDE U.S.A.

Source	Model	Product Ident. No. Prefix	Years Built	Horsepower Flywheel/ Drawbar	Transmission	Gauge m (ft)
U.K.	D4C	24A	60-64	63/50	DD	1.52 (5'0")
	D4D	88A	64-67	65/52	DD	1.52 (5'0")
	D6C	82A	64-68	120/93	DD	1.88 (6'2")
	D6C	83A	64-68	120/—	PS	1.88 (6'2")
	D6C	46J	71-77	140/—	DD	1.88 (6'2")
	D6C	47J	71-77	140/—	PS	1.88 (6'2")
	D8H	52A	59-61	235/—	PS	2.13 (7'0")
	D8H	22A	59-66	235/185	DD	2.13 (7'0")
	D8H	68A	60-66	235/—	PS	2.13 (7'0")
	D8K	66V	74-82	300/—	PS	2.13 (7'0")
Brazil	D4D	97F	69-78	75/—	DD	1.52 (5'0")
	D4D	74U	71-78	75/—	PS	1.52 (5'0")
	D6C	24U	71-77	120/93	PS	1.88 (6'2")
	D6C	23U	73-77	120/93	DD	1.88 (6'2")
	D6D	74W	77-92	140/—	DD	1.88 (6'2")
	D6D	75W	77-92	140/—	PS	1.88 (6'2")
	D6D	9FK	92-96	140/—	PS	1.88 (6'2")
	D6E	2MJ	92-96	155/—	PS	1.88 (6'2")
	D6D	19B	85-91	140/—	PS	1.88 (6'2")
	D8L	7JC	84-90	335/—	PS	2.2 (7'3")
	D8L	7YB	85-92	335/—	PS	2.2 (7'3")
D8N	7TK	93-95	285/—	PS	2.08 (6'10")	
Australia	D4	29A	59-61	63/50	DD	1.12 (3'8")
	D4	30A	59-60	63/50	DD	1.52 (5'0")
	D4C	54A	60-62	63/52	DD	1.12 (3'8")
	D4C	55A	60-62	65/52	DD	1.52 (5'0")
	D4D	85A	63-68	65/52	DD	1.52 (5'0")
	D5	51H	68-68	93/75	DD	1.88 (6'2")
	D5	52H	68-69	93/—	PS	1.88 (6'2")
	D6	31A	58-60	93/75	DD	1.52 (5'0")
	D6	32A	58-60	93/75	DD	1.18 (6'2")
	D6B	56A	60-66	90/73	DD	1.52 (5'0")
	D6B	57A	60-68	90/73	DD	1.88 (6'2")
	D6C	71A	63-68	120/93	DD	1.88 (6'2")
	D6C	73A	63-68	120/—	PS	1.88 (6'2")
	D6C	55J	69-72	125/—	DD	1.88 (6'2")
D6C	56J	69-72	125/—	PS	1.88 (6'2")	
France	D4C	69A	61-63	63/50	DD	1.52 (5'0")
	D4D	86A	63-68	65/52	DD	1.52 (5'0")
	D4D LGP	18J	66-68	65/52	DD	1.79 (5'10")
	D4D	58J	67-68	65/—	PS	1.52 (5'0")
	D4E	68X	78-86	80/—	DD	1.52 (5'0")
	D4E	69X	78-85	80/—	PS	1.52 (5'0")
	D4E LGP	71X	78-85	80/—	DD	1.77 (5'10")
	D4E LGP	72X	78-86	80/—	PS	1.77 (5'10")
	D5	62J	69-77	105/—	DD	1.88 (6'2")
	D5	63J	69-77	105/—	PS	1.88 (6'2")
	D5 LGP	6R	70-77	105/—	PS	2.06 (6'9")
	D5 LGP	12R	70-77	105/—	DD	2.06 (6'9")
	D5B	43X	77-85	105/—	DD	1.88 (6'2")
	D5B	44X	77-86	105/—	PS	1.88 (6'2")
	D5B LGP	45X	77-86	105/—	DD	2.06 (6'9")
	D5B LGP	46X	77-86	105/—	PS	2.06 (6'9")
	D5B	8MB	84-86	105/—	PS	1.52 (5'0")
	D5H	8RC	85-96	120/—	PS	1.80 (5'11")
	D5H LGP	1DD	86-96	130/—	PS	2.16 (7'1")
	D5H XL	8RJ	86-96	130/—	PS	1.89 (6'2")
	D5H	7NC	85-96	120/—	DD	1.80 (5'11")
D5H LGP	9HC	85-96	130/—	DD	2.16 (7'1")	

Former Models

Track-Type Tractors ● Made Outside U.S.A.

TRACK-TYPE TRACTORS MANUFACTURED OUTSIDE U.S.A. (cont'd)

Source	Model	Product Ident. No. Prefix	Years Built	Horsepower Flywheel/ Drawbar	Transmission	Gauge m (ft)
Scotland	D6D	19X	78-86	140/—	DD	1.88 (6'2")
	D6D	20X	78-86	140/—	PS	1.88 (6'2")
	D6D	0IY	79-87	125/—	PS	1.88 (6'2")
Glasgow	D6H	7PC	86-87	165/—	PS	1.88 (6'2")
	D6H LGP	8YC	86-87	165/—	PS	2.23 (7'4")
Japan	D3	79U	73-79	62/—	PS	1.42 (4'8")
	D3	82U	73-78	62/—	PS	1.42 (4'8")
	D3 LGP	6N	73-79	62/—	PS	1.65 (5'5")
	D3 LGP	83U	73-79	62/—	PS	1.65 (5'5")
	D3B	23Y	79-87	65/—	PS	1.42 (4'8")
	D3B LGP	24Y	79-87	65/—	PS	1.65 (5'5")
	D3B	27Y	79-87	65/—	PS	1.42 (4'8")
	D3B LGP	28Y	79-87	65/—	PS	1.65 (5'5")
	D3B	3YC	85-87	65/—	DD	1.42 (4'8")
	D3B LGP	5MC	85-87	65/—	DD	1.65 (5'5")
	D3C	5KG	87-90	67/—	PS	1.42 (4'7")
	D3C Series II	7JG/4HJ	90-93	70/—	PS	1.42 (4'7")
	D3C LGP	1PJ	87-90	67/—	PS	1.65 (5'4")
	D3C LGP Series II	8GD/5CJ	90-93	70/—	PS	1.65 (5'4")
	D4D LGP	67A	65-68	65/52	DD	1.79 (5'10")
	D4D	91A	65-68	65/52	DD	1.52 (5'0")
	D4E	50X	77-86	80/—	DD	1.52 (5'0")
	D4E	51X	77-86	80/—	PS	1.52 (5'0")
	D4E LGP	52X	77-86	80/—	DD	1.77 (5'10")
	D4C	1RJ	87-90	78/—	PS	1.42 (4'7")
	D4C Series II	7KG	90-93	80/—	PS	1.42 (4'7")
	D4C LGP	2CJ	87-90	78/—	PS	1.65 (5'4")
	D4C LGP Series II	98G	90-93	80/—	PS	1.65 (5'4")
	D4H	8PB	85-96	90/95	PS	1.67 (5'5")
	D4H LGP	9DB	85-96	105/—	PS	2.0 (6'7")
	D4H	2AC	85-92	90/95	DD	1.67 (5'5")
	D4H LGP	3AC	85-90	90/95	DD	2.0 (6'7")
	D4H XL	8PJ	92-96	105/—	PS	1.77 (5'10")
	D4H LGP	9GJ	92-96	105/—	PS	2.0 (6'7")
	D4H LGP	4NK	92-93	105/—	DD	2.0 (6'7")
	D5	37J	67-68	93/75	DD	1.88 (6'2")
	D5 LGP	98A	67-68	93/75	DD	2.06 (6'9")
	D5	67J	68-77	105/—	DD	1.88 (6'2")
	D5	97J	71-76	105/—	PS	1.88 (6'2")
	D5 LGP	68J	68-77	105/—	DD	2.06 (6'9")
	D5B	47X	77-86	105/—	DD	1.88 (6'2")
	D5B	48X	77-86	105/—	PS	1.88 (6'2")
	D5B LGP	49X	77-86	105/—	DD	2.06 (6'9")
	D5C	6PJ	91-93	90/—	PS	1.54 (5'1")
	D5C LGP	3MK	91-93	90/—	PS	1.72 (5'8")
	D5H	3MD	86-96	120/—	PS	1.80 (5'11")
	D5H LGP	4KD	86-96	130/—	PS	2.16 (7'1")
	D5H	1YD	86-96	120/—	DD	1.80 (5'11")
	D5H LGP	2SD	86-96	130/—	DD	2.16 (7'1")
	D6B	37H	66-67	93/75	DD	1.88 (6'2")
	D6B LGP	38H	66-67	93/75	DD	2.06 (6'9")
	D6C	41A	66-68	120/93	DD	1.88 (6'2")
D6C	96A	66-68	120/93	PS	1.88 (6'2")	
D6C	26K	68-77	125/—	DD	1.88 (6'2")	
D6C	69C	68-77	125/—	PS	1.88 (6'2")	
D6C LGP	90B	71-77	140/—	DD	2.11 (6'11")	
D6D LGP LS	6HC	86-96	160/—	DD	1.88 (6'2")	
D6D	31X	86-98	140/—	PS	1.88 (6'2")	
D6D	30X	85-96	140/—	DD	1.88 (6'2")	
D6D PTNR	5YB	88-96	160/—	PS	1.88 (6'2")	
D7H	25B	85-92	215/—	DD	1.98 (6'6")	
						2.54 (8'5")
D7H LGP	82Z	85-92	215/—	DD	2.23 (7'4")	3.15 (10'4")



AGRICULTURAL TRACTORS

Model	Product Ident. No. Prefix	Years Built	Horse-power FW/ Drawbar	Approx. Machine Weight kg (lb)	Height m (ft) Gauge m (ft)	Drawbar Pull kg (lb)* and Forward Speed km/h (mph)									
						1st	2nd	3rd	4th	5th	6th	7th	8th	9th	10th
						Forward Speed km/h (mph)									
Challenger 65	7YC	87-90	270/200	14 061 (31,000)	3.24	14 825	10 393	8880	7701	6656	5708	4950	4245	2858	1725
					(10'8")	(32,684)	(22,912)	(19,577)	(16,978)	(14,674)	(12,583)	(10,912)	(9358)	(6300)	(3803)
					2.15 (7'1")	4.2 (2.6)	6.4 (4.0)	7.5 (4.7)	8.6 (5.3)	9.9 (6.1)	11.3 (7.0)	13.0 (8.1)	14.9 (9.3)	19.3 (12.0)	29.3 (18.1)
Challenger 65B	7YC	91-92	285/225	14 060 (31,000)	3.24	14 893	11 074	9492	8252	7138	6109	5294	4545	3057	1851
					(10'8")	(32,914)	(24,413)	(20,926)	(18,193)	(15,737)	(13,467)	(11,672)	(10,019)	(6740)	(4080)
					2.15 (7'1")	4.2 (2.6)	6.4 (4.0)	7.5 (4.7)	8.6 (5.3)	9.9 (6.1)	11.3 (7.0)	13.0 (8.1)	14.9 (9.3)	19.3 (12.0)	29.3 (18.1)
Challenger 65C	2ZJ	93-95	285/225	14 330 (31,530)	3.24	12 587	9574	8186	7156	6147	5230	4497	3855	2701	1637
					(10'8")	(27,750)	(21,106)	(18,046)	(15,775)	(13,551)	(11,530)	(9914)	(8498)	(5955)	(3610)
					2.29 (7'5")	4.2 (2.6)	6.4 (4.0)	7.5 (4.7)	8.6 (5.3)	9.9 (6.1)	11.3 (7.0)	13.0 (8.1)	14.9 (9.3)	19.3 (12.0)	29.1 (18.1)
Challenger 65D	2ZJ	95-97	300	14 909 (32,875)	3.24	12 689	10 706	9161	7934	6837	5843	5005	4256	3119	2030
					(10'8")	(27,975)	(23,603)	(20,197)	(17,492)	(15,072)	(12,881)	(11,034)	(9382)	(6875)	(4475)
					2.29 (7'5")	4.2 (2.6)	6.4 (4.0)	7.5 (4.7)	8.6 (5.3)	9.9 (6.1)	11.3 (7.0)	13.0 (8.1)	14.9 (9.3)	19.3 (12.0)	29.1 (18.1)
Challenger 70C	2YL	93-95	1st Gear	16 201 (35,685)	3.24	12 621	9574	8186	7156	6147	5230	4497	3855	2701	1637
			215/154		(10'8")	(27,825)	(21,106)	(18,046)	(15,775)	(13,551)	(11,530)	(9914)	(8498)	(5955)	(3610)
			2nd & up 285/225		2.29 (7'5")	4.2 (2.6)	6.4 (4.0)	7.5 (4.7)	8.6 (5.3)	9.9 (6.1)	11.3 (7.0)	13.0 (8.1)	14.9 (9.3)	19.3 (12.0)	29.1 (18.1)
Challenger 75	4CJ	91-92	325/256	14 060 (31,000)	3.24	15 391	12 371	10 753	9382	8073	6923	6017	5162	3588	2181
					(10'8")	(33,931)	(27,273)	(23,706)	(20,684)	(17,797)	(15,263)	(13,264)	(11,379)	(7910)	(4830)
					2.15 (7'1")	4.2 (2.6)	6.4 (4.0)	7.5 (4.7)	8.6 (5.3)	9.9 (6.1)	11.3 (7.0)	13.0 (8.1)	14.9 (9.3)	19.3 (12.0)	29.3 (18.1)
Challenger 75C	4KK		325/268	15 158 (33,419)	3.24	12 689	10 761	9329	8106	6932	5944	5095	4380	3075	1878
					(10'8")	(27,975)	(23,724)	(20,567)	(17,871)	(15,282)	(13,105)	(11,232)	(9657)	(6780)	(4140)
					2.29 (7'5")	4.2 (2.6)	6.4 (4.0)	7.5 (4.7)	8.6 (5.3)	9.9 (6.1)	11.3 (7.0)	13.0 (8.1)	14.9 (9.3)	19.3 (12.0)	29.1 (18.1)
Challenger 75D	5AR	96-97	330	14 878 (32,800)	3.24	12 884	12 562	10 919	9526	8197	7030	6109	5241	3643	2225
					(10'8")	(28,406)	(27,693)	(24,071)	(21,003)	(18,071)	(15,498)	(13,468)	(11,554)	(8031)	(4904)
					2.29 (7'5")	4.2 (2.6)	6.4 (4.0)	7.5 (4.7)	8.6 (5.3)	9.9 (6.1)	11.3 (7.0)	13.0 (8.1)	14.9 (9.3)	19.3 (12.0)	29.1 (18.1)
Challenger 85C	9TK		1-2 Gears	355/272	3.24	12 689	11 596	9544	8302	7089	6406	5490	4720	3146	2024
			325/216		(10'8")	(27,975)	(25,565)	(21,042)	(18,304)	(15,629)	(14,122)	(12,104)	(10,406)	(6935)	(4461)
			3-10 Gears		2.29 (7'5")	4.5 (2.8)	6.4 (4.0)	7.9 (4.9)	9.0 (5.6)	10.5 (6.5)	11.3 (7.0)	13.0 (8.1)	14.9 (9.3)	20.3 (12.6)	29.1 (18.1)
Challenger 85D	4GR	96-97	Gears	15 286 (33,700)	3.24	15 529	10 684	9599	8247	7175	6590	5705	4887	3825	2461
			1-2 330		(10'8")	(34,234)	(23,553)	(21,162)	(18,181)	(15,819)	(14,528)	(12,578)	(10,774)	(8432)	(5425)
			3-5 360		2.29 (7'5")	4.0 (2.5)	6.25 (3.9)	7.75 (4.8)	8.9 (5.5)	10.2 (6.4)	11.2 (7.0)	12.8 (8.0)	14.7 (9.2)	20.3 (12.6)	29.1 (18.1)
D3B SA	2PC	85-87	101	6650 (14,670)	2.71	7634	6226	5306	4531	3888					
					(8'11")	(16,830)	(13,725)	(11,700)	(9990)	(8573)					
D3C SA	7JF	87-92	101	7202 (15,846)	2.71	5552	4521	3827	3235	2755					
					(8'11")	(12,250)	(9960)	(8450)	(7130)	(6070)					
					1.52 (5'0")	4.1 (2.5)	5.0 (3.1)	5.7 (3.6)	6.5 (4.0)	7.6 (4.7)					

*Drawbar pull figures for SA and SR models are max. at lug.

NOTE: Drawbar pull figures for the Challenger 65 is at max. power as found in University of Nebraska Tractor Test no. 1268. This test was performed on concrete. Therefore, usable drawbar pull may be less depending upon soil conditions.

Agricultural Tractors (cont'd)

Model	Product Ident. No. Prefix	Years Built	Horse-power FW/ Drawbar	Approx. Machine Weight kg (lb)	Height m (ft) Gauge m (ft)	Drawbar Pull kg (lb)* and Forward Speed km/h (mph)									
						1st	2nd	3rd	4th	5th	6th	7th	8th	9th	10th
D4D SA	20J	66-68	—/68	6750 (14,900)	2.44	4590	3928	3098	2631	2232					
					(8'0")	(10,120)	(8660)	(6830)	(5800)	(4920)					
					1.52	4.0	4.7	5.6	6.4	7.4					
D4D SA	84J	66	—/68	6470 (14,270)	2.67	4880	4170	3310	2840	2420					
					(8'9")	(10,750)	(9200)	(7300)	(6260)	(5330)					
					1.52	4.0	4.7	5.6	6.4	7.4					
D4E SA	7PB 2CB	84-89 84-91	97	7600 (16,760)	2.71	5901	5148	5831	5002	4433					
					(8'11")	(13,102)	(11,349)	(12,859)	(11,027)	(9773)					
					3.4	4.6	5.5	6.4	8.3						
D4E SA	29X	77-84	—/74	7585 (16,722)	2.72	5802	4986	4007	3814	2896					
					(8'11")	(12,791)	(10,993)	(8835)	(8408)	(6384)					
					1.52	4.1	4.7	5.8	6.6	7.5					
D5 SA	21J	67-67	—/90	9300 (20,400)	2.64	6620	5160	3990	3080	2290					
					(8'8")	(14,580)	(11,360)	(8740)	(6790)	(5030)					
					1.88										
D5 SA	98J	67-77	—/90	9660 (21,300)	2.95	6120	5180	4110	3640	2950	2250				
					(9'8")	(13,500)	(11,410)	(9950)	(7620)	(6500)	(4970)				
					1.88	3.7	4.6	5.8	7.1	8.8					
D5B SA	26X	77-84	—/90	11 283 (24,875)	2.77	6409	5384	4323	3688	3180	2486				
					(9'1")	(14,130)	(11,870)	(9530)	(8130)	(7010)	(5480)				
					1.88	4.0	4.7	5.6	6.6	7.4	9.0				
D5B SA	22X	77-82	105/—	11 619 (25,615)	2.77	8060	5030	3410	2290	1480					
					(9'1")	(17,770)	(11,100)	(7520)	(5060)	(3260)					
					1.52	2.7	4.2	5.8	8.0	11.1					
D5B SA	24X	77-84	105/—	11 619 (25,615)	2.77										
					(9'1")										
					1.52	3.5	6.1	10.1							
					(5'0")	(2.2)	(3.8)	(6.3)							

*Drawbar pull figures for SA and SR models are max. at lug.

NOTE: Drawbar pull figures for the Challenger 65 is at max. power as found in University of Nebraska Tractor Test no. 1268.

This test was performed on concrete. Therefore, usable drawbar pull may be less depending upon soil conditions.

Agricultural Tractors (cont'd)

Model	Product Ident. No. Prefix	Years Built	Horse-power FW/ Drawbar	Approx. Machine Weight (kg (lb))	Height m (ft) Gauge m (ft)	Drawbar Pull kg (lb)* and Forward Speed km/h (mph)													
						1st	2nd	3rd	4th	5th	6th	7th	8th	9th	10th				
D6C SA	17R	70-76	140	13 064 (28,800)	2.67 (8'9")	850 (18,750)	6970 (15,370)	5880 (12,780)	4810 (10,610)	4080 (9000)	3190 (7030)								
						4.0 (2.5)	4.8 (3.0)	5.6 (3.5)	6.4 (4.0)	7.4 (4.6)	8.8 (5.5)								
D6D SR	7XF	89-91	140	15 200 (33,500)	2.87 (9'5")	14 358 (31,645)	12 429 (27,394)	11 721 (25,833)	7067 (15,576)	6096 (13,436)	4931 (10,868)								
						2.0 (1.2)	2.9 (1.8)	4.1 (2.5)	6.5 (4.0)	7.4 (4.6)	8.9 (5.5)								
D6D SA 123-161 kW (165-215 HP)	38C	83-91	165	14 500 (32,000)	2.87 (9'5")	10 098 (22,243)	8510 (18,744)	9210 (20,287)	7789 (17,156)	6732 (14,828)	5456 (12,017)								
						4.5 (2.8)	5.3 (3.3)	6.1 (3.8)	7.1 (4.4)	8.2 (5.1)	9.8 (6.1)								
D6D SA 123-179 kW (165-240 HP)	19B	83-91	165	14 500 (32,000)	2.87 (9'5")	10 098 (22,243)	8510 (18,744)	7181 (15,817)	8732 (19,234)	7560 (16,651)	6144 (13,532)								
						4.5 (2.8)	5.3 (3.3)	6.1 (3.8)	7.1 (4.4)	8.2 (5.1)	9.8 (6.1)								
D6E SR	8FJ	91-96	155/216 121/170	14 960 (32,987)	2.03 (6'8") 1.88 (6'2")	11 308 (24,878)	7771 (17,097)	8130 (17,887)	6866 (15,105)	5926 (13,037)	3135 (6987)								
						3.0 (1.9)	4.3 (2.7)	5.8 (2.6)	6.8 (4.3)	7.7 (4.8)	9.3 (5.8)								
Ag 6 Generation One	05X	77-86	165/240	14 787 (32,600)	3.43 (11'3")	10 034 (22,120)	8455 (18,639)	7134 (15,727)	9041 (19,931)	7830 (17,268)									
						4.5 (2.8)	5.3 (3.3)	6.1 (3.8)	7.1 (4.4)	8.2 (5.1)									
Ag 6 Generation Two	05X	77-86	200/240	14 787 (32,600)	3.48 (11'5")	12 407 (27,353)	10 482 (23,110)	10 667 (23,514)	9091 (19,931)	7830 (17,263)									
						4.5 (2.8)	5.3 (3.3)	6.1 (3.8)	7.1 (4.4)	8.2 (5.1)									
D7G SA std. trans.	35N	80-86	250	18 462 (40,700)	3.2 (10'6")	19 101 (42,110)	13 622 (30,030)	11 358 (25,040)	10 015 (22,080)	8627 (19,020)	7584 (16,720)								
						3.5 (2.2)	4.8 (3.0)	5.6 (3.5)	6.4 (4.0)	7.2 (4.5)	8.2 (5.1)								
D7G SA std. trans. 168-186 kW (225-250 HP)		77-86	250	18 462 (40,700)	3.2 (10'6")	16 990 (37,424)	12 090 (26,631)	11 358 (25,040)	10 015 (22,080)	8627 (19,020)	7584 (16,720)								
						3.5 (2.2)	4.8 (3.0)	5.6 (3.5)	6.4 (4.0)	7.2 (4.5)	8.2 (5.1)								
D8L SA		84-87	400	36 650 (80,820)	3.87 (12'8") 2.2 (7'3")	40 252 (88,740)	39 466 (64,960)	22 013 (48,530)	15 953 (35,170)	11 880 (26,190)	8446 (18,620)								
						2.9 (1.8)	3.9 (2.4)	5.0 (3.1)	6.8 (4.2)	8.9 (5.5)	11.9 (7.4)								

*Drawbar pull figures for SA and SR models are max. at lug.

NOTE: Drawbar pull figures for the Challenger 65 is at max. power as found in University of Nebraska Tractor Test no. 1268.

This test was performed on concrete. Therefore, usable drawbar pull may be less depending upon soil conditions.



MOTOR GRADERS

Model	Product Ident. No. Prefix	Years Built	Horsepower, Rated	Approx. Ship Wt. kg (lb)	Wheel-base m (ft)	Length m (ft)	Width m (ft)	Mold-board Length m (ft)	Turning Radius m (ft)	Controls	Maximum Speed km/h (mph)	
											Forward	Rev.
212TD	79C	54-57	50	6030 (13,290)	5.03 (16'6")	6.68 (21'11")	2.07 (6'10")	3.05 (10'0")	11.10 (36'5")	Mech.	18.1 (11.2)	4.2 (2.6)
112	3U	47-59	70	8770 (19,330)	5.72 (18'9")	7.59 (24'11")	2.39 (7'10")	3.66 (12'0")	10.87 (35'8")	Mech.	25.7 (16.0)	6.4 (4.0)
112	81C	55-59	75	9435 (20,805)	5.72 (18'9")	7.59 (24'11")	2.39 (7'10")	3.66 (12'0")	10.74 (35'3")	Mech.	25.7 (16.0)	6.4 (4.0)
112E	68E(U.S.) 91G(U.S.)	59-64 64-68	85	9500 (20,900)	5.72 (18'9")	7.62 (25'0")	2.36 (7'9")	3.66 (12'0")	10.74 (35'3")	Mech.	29.3 (18.2)	9.3 (5.8)
112F	82F(U.S.) 46D(U.S.) 74H(U.S.) 89J(U.S.) 80J(AUSTL)	60-64 64-68 67-68 68-74 69-84	100	9800 (21,600)	5.72 (18'9")	7.82 (25'8")	2.36 (7'9")	3.66 (12'0")	10.70 (35'3")	Mech.	29.9 (18.6)	9.7 (6.0)
120	89G(U.S.)	64-67	115	10 480 (23,100)	5.71 (18'9")	7.62 (25'0")	2.36 (7'9")	3.66 (12'0")	10.74 (35'3")	Mech.	32.2 (20.0)	10.3 (6.4)
120	14K(U.S.)	67-69	125	10 600 (23,500)	5.71 (18'9")	7.80 (25'8")	2.36 (7'9")	3.66 (12'0")	10.74 (35'3")	Mech.	32.2 (20.0)	41.5 (25.8)
120	10R(U.S.)	69-74	125	10 700 (23,700)	5.85 (19'2")	7.95 (26'1")	2.36 (7'9")	3.66 (12'0")	10.90 (35'9")	Mech.	32.2 (20.0)	6.6 (4.1)
120	13U(U.S.)	71-74	125	11 000 (24,300)	5.85 (19'2")	7.95 (26'1")	2.36 (7'9")	3.66 (12'0")	10.90 (35'9")	Mech.	32.2 (20.0)	6.6 (4.1)
120B	64U(BRAZ)	72-89	125	12 000 (26,460)	5.85 (19'2")	7.92 (26'0")	2.36 (7'9")	3.66 (12'0")	10.90 (35'9")	Mech.	35.4 (22.0)	23.8 (14.8)
120G	87V(U.S.) 4HD(BRAZ) 11W(AUSTL) 82V(CAN)	73-95 86-95 75-95 74-80	125	12 859 (28,350)	5.69 (18'8")	7.92 (26'0")	2.45 (8'0")	3.66 (12'0")	6.7 (22'0")	Hyd.	40.9 (25.4)	40.9 (25.4)
130G	74V(U.S.) 12W(AUSTL)	73-95 75-89	135	13 050 (28,770)	5.92 (19'5")	8.30 (27'3")	2.45 (8'0")	3.66 (12'0")	7.3 (24'0")	Hyd.	39.4 (24.5)	39.4 (24.5)
12	6M(U.S.)	39-42	66	9440 (20,820)	5.72 (18'9")	7.62 (25'0")	2.39 (7'10")	3.66 (12'0")	10.87 (35'8")	Mech.	24.5 (15.2)	6.1 (3.8)
12	9K(U.S.)	38-45	70	9590 (21,140)	5.72 (18'9")	7.62 (25'0")	2.39 (7'10")	3.66 (12'0")	10.87 (35'8")	Mech.	24.5 (15.2)	6.1 (3.8)
12	7T(U.S.)	45-47	75	9750 (21,500)	5.72 (18'9")	7.62 (25'0")	2.39 (7'10")	3.66 (12'0")	10.87 (35'8")	Mech.	24.5 (15.2)	6.1 (3.8)
12	8T(U.S.) 94C(AUSTL)	47-55 55-58	100	10 100 (22,375)	5.72 (18'9")	7.62 (25'0")	2.39 (7'10")	3.66 (12'0")	10.87 (35'8")	Mech.	31.1 (19.3)	6.6 (4.1)
12	70D-71D(U.S.) 80C(U.S.) 38E(AUSTL)	57-59 55-67 58-60	115	10 200 (22,410)	5.72 (18'9")	7.62 (25'0")	2.37 (7'10")	3.66 (12'0")	10.87 (35'8")	Mech.	31.1 (19.3)	10.1 (6.3)

Motor Graders (cont'd)

Model	Product Ident. No. Prefix	Years Built	Horsepower, Rated	Approx. Ship Wt. kg (lb)	Wheel-base m (ft)	Length m (ft)	Width m (ft)	Mold-board Length m (ft)	Turning Radius m (ft)	Controls	Maximum Speed km/h (mph)	
											Forward	Rev.
12E	99E(U.S.) 21F(AUSTL) 17K(AUSTL)	59-65 60-68 68-75	115	11 100 (24,400)	5.72 (18'9")	8.03 (26'4")	2.36 (7'9")	3.66 (12'0")	10.90 (35'9")	Mech.	32.0 (19.9)	22.2 (13.8)
12F	73G(U.S.)	65-67	115	12 973 (28,600)	6.0 (19'8")	8.20 (26'10")	2.36 (7'9")	3.66 (12'0")	11.40 (37'5")	Hyd. Mech.	32.0 (19.9)	22.2 (13.8)
12F	89H(U.S.) 13K(U.S.)	69-73 67-73	125	12 973 (28,600)	6.0 (19'8")	8.20 (26'10")	2.36 (7'9")	3.65 (12'0")	11.40 (37'5")	Hyd. Mech.	34.3 (21.3)	41.5 (25.8)
12G	61M(U.S.) 3PL(BRAZ) 3WC(AUSTL)	73-95 93-95 85-95	135	13 554 (29,860)	5.92 (19'5")	8.30 (27'3")	2.45 (8'0")	3.66 (12'0")	7.3 (24'0")	Hyd.	39.4 (24.5)	39.4 (24.5)
140	14U(U.S.) 11R(U.S.) 55F(AUSTL) 24R(CAN)	71-74 70-74 71-75 71-74	150	13 109 (28,900)	5.84 (19'2")	7.95 (26'1")	2.44 (8'0")	3.66 (12'0")	10.97 (36'0")	Mech.	38.8 (24.1)	47.0 (29.2)
140B	61S(BRAZ)	81-87	150	13 620 (30,003)	6.14 (20'2")	8.07 (26'6")	2.39 (7'10")	3.96 (13'0")	11.60 (38'0")	Mech.	37.6 (23.4)	25.6 (15.9)
140G	72V(U.S.) 5MD(BRAZ) 13W(AUSTL) 81V(CAN)	73-95 87-95 75-95 74-80	150	14 102 (31,090)	5.92 (19'5")	8.33 (27'4")	2.45 (8'0")	3.66 (12'0")	7.3 (24'0")	Hyd.	41.0 (25.5)	41.0 (25.5)
140G AWD	72V(U.S.)	73-95	150	14 914 (32,880)	5.92 (19'5")	8.33 (27'4")	2.45 (8'0")	3.66 (12'0")	7.3 (24'0")	Hyd.	41.0 (25.5)	41.0 (25.5)
14B	78E(U.S.) 64C(U.S.)	59-59 59-69	150	13 300 (29,280)	5.84 (19'2")	8.03 (26'4")	2.44 (8'0")	3.66 (12'0")	10.97 (36'0")	Mech.	34.8 (21.6)	11.3 (7.0)
14C	35F(U.S.)	59-61	150	12 973 (28,600)	5.84 (19'2")	8.03 (26'4")	2.44 (8'0")	3.66 (12'0")	10.97 (36'0")	Mech.	34.8 (21.6)	11.3 (7.0)
14D	96F(U.S.)	61-65	150	13 700 (30,300)	6.15 (20'2")	8.33 (27'4")	2.44 (8'0")	3.96 (13'0")	11.58 (38'0")	Mech.	34.1 (21.2)	23.5 (14.6)
14E	99G(U.S.)	65-68	150	13 699 (30,200)	6.15 (20'2")	8.33 (27'4")	2.44 (8'0")	3.96 (13'0")	11.58 (38'0")	Hyd. Mech.	36.4 (22.6)	24.9 (15.5)
14E	12K(U.S.) 72G(U.S.)	67-73 69-73	150	14 300 (31,600)	6.10 (20'2")	8.30 (27'4")	2.44 (8'0")	3.96 (13'0")	11.60 (38'0")	Hyd. Mech.	39.1 (24.3)	47.3 (29.4)
14G	96U(U.S.)	73-95	200	20 688 (45,610)	6.45 (21'2")	9.21 (30'3")	2.83 (9'3")	4.27 (14'0")	7.9 (25'11")	Hyd.	43.0 (26.8)	50.1 (31.1)
16	49G(U.S.)	63-73	225	22 499 (49,600)	6.86 (22'6")	9.50 (31'2")	3.00 (9'10")	4.27 (14'0")	13.56 (44'6")	Hyd. Mech.	49.7 (30.9)	49.7 (30.9)
16G	93U(U.S.)	73-95	275	27 284 (60,150)	6.96 (22'10")	9.99 (32'8")	3.08 (10'1")	4.88 (16'0")	8.2 (27'0")	Hyd.	43.6 (27.1)	43.6 (27.1)



HYDRAULIC EXCAVATORS (Track)

Model	Product Ident. No. Prefix COSA (US)	Years Built	Flywheel Horsepower	Approx. Operating Weight kg (lb)	Track Gauge m (ft)	Height* m (ft)	Length* m (ft)	Width m (ft)	Max. Reach** m (ft)	Lift Capacity*** kg (lb)
205 LC	(3HC) (4DC)	84-89	Deutz-67 Perkins-71	13 135 (28,957)	1.895 (6'2.5")	3.00 (9'10")	7.30 (23'11")	2.40 (7'10")	8.17 (26'10")	3290 (7300)
205B	5ZF	90-92	80	12 900 (28,443)	1.895 (6'2.5")	2.976 (9'9")	7.67 (25'2")	2.495 (8'2")	8.9 (29'2")	3740 (8250)
211 LC	(4EC) (5CC)	84-89	Deutz-84 Perkins-94	15 540 (34,260)	2.08 (6'9.9")	3.02 (9'11")	8.01 (26'3")	2.49 (8'2")	9.88 (32'5")	4240 (9340)
213 LC	3ZC	83-87	102	17 300 (38,140)	2.08 (6'10")	3.08 (10'1")	8.34 (27'4")	2.49 (8'2")	10.30 (33'9.5")	5127 (11,305)
215	(96L) (57Z) (14Z)	76-80 79-84	85 90	17 450 (38,480)	1.92 (6'4")	3.10 (10'1")	8.94 (29'4")	2.47 (8'0")	9.25 (30'4")	5090 (11,200)
215 SA	(57Y) (14Z)	82-84	90	19 440 (42,860)	2.18 (7'2")	3.22 (10'6")	8.94 (29'4")	2.73 (8'11")	9.23 (30'3")	5130 (11,300)
215B LC	(9YB)	84-87	105	18 510 (40,806)	1.92 (6'4")	3.10 (10'2")	8.94 (29'4")	2.44 (8'0")	9.25 (30'4")	5760 (12,700)
215C LC	(4HG)	87-89	115	19 570 (43,150)	1.92 (6'4")	3.1 (10'2")	8.94 (29'4")	2.42 (7'11")	9.29 (30'6")	7070 (15,200)
215D LC	(9TF)	89-92	125	19 900 (43,900)	1.92 (6'4")	3.2 (10'6")	9.0 (24'6")	2.44 (8'0")	9.23 (30'3")	6830 (14,700)
219	(5CF)	87-89	130	21 120 (46,550)	2.18 (7'2")	3.12 (10'3")	8.94 (29'4")	2.73 (8'11")	10.39 (34'1")	7080 (15,300)
219D	(5XG)	89-92	140	21 600 (47,500)	2.18 (7'2")	3.12 (10'3")	9.41 (30'10")	2.73 (8'11")	9.75 (32'0")	7670 (16,500)
219 LC	(5CF)	87-89	130	22 020 (48,550)	2.18 (7'2")	3.12 (10'3")	8.94 (29'4")	2.73 (8'11")	10.39 (34'1")	7080 (15,300)
219D LC	(5XG)	89-92	140	22 400 (49,300)	2.18 (7'2")	3.12 (10'3")	9.41 (30'10")	2.73 (8'11")	9.75 (32'0")	7670 (16,500)
225 LC	(51U)	72-86	135	23 900 (52,700)	2.64 (8'8")	3.17 (10'5")	9.83 (32'3")	2.99 (9'10")	9.58 (31'5")	7300 (15,600)
225 SA	(51U)	77-86	135	27 125 (59,800)	2.64 (8'8")	3.17 (10'5")	9.83 (32'3")	3.35 (11'0")	9.55 (31'4")	7340 (15,700)
225B	(2ZD) (3YD)	86-89 87-89	145	24 960 (55,030)	2.44 (8'0")	3.17 (10'5")	9.83 (32'3")	2.99 (9'10")	10.16 (33'4")	11 040 (26,100)
225D	(6RG)	89-91	150	25 400 (55,900)	2.44 (8'0")	3.23 (10'7")	9.94 (32'7")	2.99 (9'10")	10.13 (33'3")	—
225B LC	(2ZD) (3YD)	86-89 87-89	145	26 140 (58,230)	2.44 (8'0")	3.17 (10'5")	9.83 (32'3")	2.99 (9'10")	10.16 (33'4")	11 040 (26,100)
225D LC	(2SJ)	89-91	165	26 700 (58,900)	2.44 (8'0")	3.23 (10'7")	9.94 (32'7")	2.99 (9'10")	10.13 (33'3")	12 450 (26,900)

*When shipped with medium stick and bucket curled under.

**Maximum reach at ground level, one-piece boom, longest stick.

***Lift capacity at 4.6 m (15'0") over front, one-piece boom, longest stick.

Hydraulic Excavators (cont'd)

Model	Product Ident. No. Prefix COSA (US)	Years Built	Flywheel Horsepower	Approx. Operating Weight kg (lb)	Track Gauge m (ft)	Height* m (ft)	Length* m (ft)	Width m (ft)	Max. Reach** m (ft)	Lift Capacity*** kg (lb)
229	(1GF)	86-89	145	29 140	2.64	3.38	9.83	3.45	10.11	—
	(1AF)	86-89		(64,830)	(8'8")	(11'1")	(32'3")	(11'4")	(33'2")	
229 LC	(1GF)	86-89	180	33 540	2.64	3.38	11.02	3.45	11.35	7940
Custom 180				(73,940)	(8'8")	(11'1")	(36'2")	(11'4")	(37'3")	(17,100)
229D	(2LJ)	89-91	157	31 700	2.64	3.52	10.9	3.25	10.76	8300
				(69,900)	(8'8")	(11'7")	(35'9")	(10'8")	(35'4")	(18,300)
231D		90-92	200	34 300	2.64	3.45	10.83	3.45	11.20	15 300
				(75,600)	(8'8")	(11'4")	(35'6")	(11'4")	(36'9")	(33,000)
231D LC		90-92	200	35 500	2.64	3.45	10.83	3.45	11.20	15 300
				(78,100)	(8'8")	(11'4")	(35'6")	(11'4")	(36'9")	(33,000)
235	(32K)	73-86	195	39 320	2.69	3.40	11.27	3.45	11.23	7050
	(64R)			(86,700)	(8'10")	(11'2")	(37'0")	(11'4")	(36'10")	(17,300)
235B	(7WC)	86-88	215	40 960	2.69	3.40	11.27	3.45	11.23	9934
	(9PC)			(89,700)	(8'10")	(11'2")	(37'0")	(11'4")	(36'10")	(21,900)
235C	(4DG) (5AF)	88-92	250	42 140	2.69	3.50	11.50	3.45	12.00	14 720
	(2PG) (3WG)			(92,800)	(8'10")	(11'4")	(37'7")	(11'4")	(39'5")	(35,000)
235D	(8KJ)	92-93	250	46 270	2.69	3.50	11.50	3.45	12.00	14 840
	(8TJ)			(103,780)	(8'10")	(11'5")	(37'7")	(11'4")	(39'5")	(35,200)
235D LC	(8KJ)	92-93	250	49 270	3.30	3.60	11.60	3.79	11.97	15 070
	(8TJ)			(108,620)	(10'10")	(11'9")	(38'1")	(12'5")	(39'3")	(35,700)
245	(82X)	74-88	325	65 745	3.24	4.62	13.18	3.71	14.02	14 930
	(84X)			(144,941)	(10'7")	(15'2")	(43'3")	(12'2")	(46'0")	(32,920)
245B	6MF	88-92	360	65 200	3.24	4.78	13.13	3.61	14.02	—
	1SJ			(143,500)	(10'7")	(15'8")	(43'1")	(11'10")	(46'0")	
245D	(4LK)	92-93	385	68 420	3.24	5.46	12.82	3.61	13.84	14 640†
	(7ZJ)			(150,520)	(10'7")	(17'11")	(42'0")	(11'10")	(45'9")	(31,600)
E70	3GB	87-89	52	6500	1.65	2.59	6.02	2.25	6.67	1300
	3CG	87-89		(14,300)	(5'5")	(8'6")	(19'9")	(7'5")	(21'10")	(2750)
E70B	7YF(JPN)	89-94	54	6760	1.75	2.56	6.09	2.32	6.72	1315
	5TG(OSJ)	89-94		(14,900)	(5'9")	(8'5")	(20'0")	(7'7")	(22'1")	(2900)
	6AK(OSJ)	92-94								
E110	3FG	87-89	74	10 700	1.9	2.73	7.345	2.5	7.93	2700
	3GG	87-89		(23,600)	(6'3")	(8'11")	(24'0")	(8'2")	(26'0")	(5750)
E110B	9HF(OSJ)	90-92	79	11 600	1.99	2.70	7.25	2.495	8.10	3350
	8MF(JPN)	90-92		(25,600)	(6'6")	(8'10")	(23'9")	(8'2")	(26'7")	(7200)
	5GK(OSJ)	90-92								
E120	1LF(OSJ)	87-89	84	12 200	1.99	2.775	7.66	2.490	8.58	3850
	1MF(JPN)	87-89		(26,800)	(6'6")	(9'1")	(25'1")	(8'2")	(28'2")	(8300)
E120B	7NF(OSJ)	90-92	84	12 680	1.99	2.70	7.62	2.495	8.74	4310
	6JF(JPN)	90-92		(28,200)	(6'6")	(8'10")	(25'10")	(8'2")	(28'8")	(9250)
	4XK(OSJ)	90-92								

*When shipped with medium stick and bucket curled under.

**Maximum reach at ground level, one-piece boom, longest stick.

***Lift capacity at 4.6 m (15'0") over front, one-piece boom, longest stick.

†@ 7.5 m (25'0") over front, one-piece boom, longest stick.

Hydraulic Excavators (cont'd)

Model	Product Ident. No. Prefix COSA (US)	Years Built	Flywheel Horsepower	Approx. Operating Weight kg (lb)	Track Gauge m (ft)	Height* m (ft)	Length* m (ft)	Width m (ft)	Max. Reach** m (ft)	Lift Capacity*** kg (lb)
E140	1PF(JPN) 1NF(OSJ)	87-94	89	13 970 (30,800)	1.99 (6'6")	2.89 (9'6")	8.29 (27'6")	2.55 (8'4")	5.49 (18'0")	4380 (9650)
E200B	6KF(OSJ) 4SG(JPN)	87-91 87-91	118	18 800 (41,400)	2.20 (7'3")	2.97 (9'9")	9.48 (31'1")	2.83 (9'4")	10.63 (34'10")	8100 (17,350)
EL200B	7DF(OSJ) 5EG(JPN)	87-91 87-91	118	20 100 (44,300)	2.38 (7'10")	2.97 (9'9")	9.48 (31'1")	3.18 (10'5")	10.63 (34'10")	8150 (17,600)
E240	1FG(OSJ) 2HF(JPN)	87-89 87-89	148	23 000 (50,700)	2.39 (7'10")	3.02 (9'11")	9.73 (31'11")	3.19 (10'6")	10.6 (34'9")	9800 (21,600)
E240B	8SF(OSJ) 9PF(JPN)	89-92	148	23 000 (50,700)	2.39 (7'10")	3.02 (9'11")	9.73 (31'11")	3.19 (10'6")	10.6 (34'9")	9800 (21,600)
E240C	2RL(OSJ) 8MK(JPN)	92-93	148	23 000 (50,700)	2.39 (7'10")	3.02 (9'11")	9.73 (31'11")	3.19 (10'6")	10.6 (34'9")	9800 (21,600)
EL240	4JF(OSJ) 4MF(JPN)	87-89 87-89	148	23 600 (52,000)	2.58 (8'6")	3.02 (9'11")	9.73 (31'11")	3.38 (11'1")	10.6 (34'9")	11 300 (24,300)
EL240B	5WG(OSJ) 6MG(JPN)	89-92	148	23 600 (52,000)	2.58 (8'6")	3.02 (9'11")	9.73 (31'11")	3.38 (11'1")	10.6 (34'9")	10 320 (22,750)
EL240C	9PK(OSJ) 9NK(JPN)	92-93	148	23 600 (52,000)	2.58 (8'6")	3.02 (9'11")	9.73 (31'11")	3.38 (11'1")	10.6 (34'9")	10 320 (22,750)
E300	2CF(OSJ) 1KG(JPN)	87-89 87-89	187	30 500 (67,300)	2.6 (8'6")	3.22 (10'7")	10.94 (35'11")	3.4 (11'2")	11.84 (38'9")	12 550 (27,650)
E300B	1WJ(OSJ) 2HJ(JPN)	90-91 90-91	206	30 200 (66,580)	2.6 (8'6")	3.22 (10'7")	10.94 (35'11")	3.4 (11'2")	11.84 (38'9")	12 450 (26,850)
EL300	4NF(OSJ) 4SF(JPN)	87-89 87-89	187	31 600 (69,700)	2.6 (8'6")	3.22 (10'7")	10.94 (35'11")	3.4 (11'2")	11.84 (38'9")	12 550 (27,650)
EL300B	3FJ(OSJ) 1GK(JPN)	90-91 90-91	206	31 200 (68,780)	2.6 (8'6")	3.22 (10'7")	10.94 (35'11")	3.4 (11'2")	11.84 (38'9")	12 450 (26,850)
E450	3HG(OSJ) 3JG(JPN)	87-93 87-93	276	46 000 (101,430)	2.89 (9'6")	3.49 (11'5")	11.96 (39'3")	3.15 (10'4")	13.08 (42'11")	10 900 (23,500)
E650	3KG(OSJ) 3LG(JPN)	87-92 87-92	375	62 600 (138,000)	3.25 (10'8")	4.84 (15'11")	14.0 (45'11")	3.49 (11'5")	13.33 (43'9")	15 850 (34,000)
307	2WM 2PM(OSJ) 9ZL(JPN)	94-97	54	7600 (16,760)	1.75 (5'9")	2.9 (9'6")	6.3 (20'8")	2.4 (7'10")	6.38 (20'11")	2450 (5390)
311	9LJ(OSJ) 5PK(JPN)	93-96 93-96	79	11 100 (24,400)	1.99 (6'6")	2.76 (9'1")	7.25 (23'9")	2.49 (8'2")	8.10 (26'7")	3100 (6650)
312	6GK(OSJ) 7DK(JPN)	93-96 93-96	84	12 600 (27,910)	1.99 (6'6")	2.76 (9'1")	7.6 (24'11")	2.49 (8'2")	8.63 (28'4")	4200 (9260)
312	6BL	93-97	84	12 600 (27,780)	1.99 (6'6")	2.76 (9'1")	7.6 (24'11")	2.49 (8'2")	8.63 (28'3")	4200 (9260)
312B	6SW 9NW(blade)	98	84	13 000 (28,665) 13 785 (30,395)	1.99 (6'6") 1.99 (6'6")	2.91 (9'6") 2.91 (9'6")	7.59 (24'11") 7.59 (24'11")	2.49 (8'2") 2.49 (8'2")	8.30 (27'3") 8.30 (27'3")	4590 (10,120) 4940 (10,890)
312B L	9FS 2KW(blade)	97	84	13 270 (29,260) 14 055 (30,990)	1.99 (6'6") 1.99 (6'6")	2.91 (9'6") 2.91 (9'6")	7.59 (24'11") 7.59 (24'11")	2.59 (8'6") 2.59 (8'6")	8.30 (27'3") 8.30 (27'3")	5000 (11,025) 5050 (11,135)

*When shipped with medium stick and bucket curled under.

**Maximum reach at ground level, one-piece boom, longest stick.

***Lift capacity at 4.6 m (15'0") over front, one-piece boom, longest stick.

Hydraulic Excavators (cont'd)

Model	Product Ident. No. Prefix COSA (US)	Years Built	Flywheel Horsepower	Approx. Operating Weight kg (lb)	Track Gauge m (ft)	Height* m (ft)	Length* m (ft)	Width m (ft)	Max. Reach** m (ft)	Lift Capacity*** kg (lb)
315	4YM(OSJ)	94-97	99	15 300	1.99	2.88	8.5	2.49	8.74	5250
	6XM(JPN)	94-97		(33,730)	(6'6")	(9'5")	(28'0")	(8'2")	(28'8")	(11,290)
315 L	6YM(OSJ)	94-97	99	15 920	1.99	2.88	8.5	2.59	8.74	6320
				(35,100)	(6'6")	(9'5")	(28'0")	(8'6")	(28'8")	(13,570)
315	3ZM	95-98	99	15 920	1.99	2.88	8.5	2.49	8.21	5300
				(35,100)	(6'6")	(9'5")	(28'0")	(8'2")	(26'11")	(11,300)
317	4MM	95-98	99	17 260	2.15	2.88	8.5	2.75	8.62	4210
				(38,050)	(7'1")	(9'5")	(28'0")	(9'0")	(28'3")	(9280)
317N	9SR	96-98	99	17 220	1.99	2.88	8.5	2.75	8.62	6450
				(37,960)	(6'6")	(9'5")	(28'0")	(9'0")	(28'3")	(14,200)
318B L	9WW	98	110	17 700	2.20	3.02	8.67	2.80	8.94	8440
				(39,030)	(7'2")	(9'10")	(28'6")	(9'2")	(29'4")	(18,610)
318B LN	6DZ	98	110	17 160	1.995	3.02	8.67	2.495	8.94	7590
				(37,840)	(6'6")	(9'10")	(28'6")	(8'2")	(29'4")	(16,735)
320	7WK(OSJ)	91-96	128	19 120	2.20	2.93	9.37	2.80	10.63	6200
	2DL(OSJ)			(42,150)	(7'3")	(9'7")	(30'9")	(9'2")	(34'9")	(17,700)
	8LG(OSJ)									
	7GJ(JPN)									
	3XM(JPN)									
	4ZJ(GOS)									
320L	1TL(OSJ)	91-96	128	20 370	2.38	2.93	9.37	3.18	10.63	8150
	9KK(OSJ)			(44,910)	(7'10")	(9'7")	(30'9")	(10'5")	(34'9")	(17,600)
	8HJ(JPN)									
	4JM(JPN)									
	3XK(GOS)									
320N	1XM(OSJ)	94-96	128	20 050	1.90	2.93	9.37	2.59	10.63	8150
	9WG(GOS)			(44,150)	(6'6")	(9'7")	(30'9")	(8'6")	(34'9")	(17,600)
320S	6KM									
322*	7WL(OSJ)	93-96	153	22 650	2.39	3.12	9.95	2.99	10.47	10 400
	7WL(JPN)			(50,000)	(7'10")	(10'3")	(32'8")	(9'10")	(34'4")	(22,500)
322L*	8CL(OSJ)	93-96	153	23 950	2.59	3.12	9.95	3.39	10.47	10 400
	8CL(JPN)			(52,800)	(8'6")	(10'3")	(32'8")	(11'1")	(34'4")	(22,500)
325*	5WK(OSJ)	91-95	168	25 520	2.39	3.24	10.27	2.99	11.50	11 100
	8NL(OSJ)			(56,270)	(7'10")	(10'8")	(33'8")	(9'10")	(37'7")	(24,000)
	8JG(JPN)	91-95	168	25 520	2.39	3.24	10.27	2.99	11.50	11 000
	5WK(JPN)			(56,270)	(7'10")	(10'8")	(33'8")	(9'10")	(37'7")	(24,000)
325L*	6KK(OSJ)	91-95	168	27 010	2.59	3.24	10.27	3.39	11.50	11 650
	9KL(OSJ)			(59,560)	(8'6")	(10'8")	(38'8")	(11'1")	(37'7")	(25,150)
	7CJ(JPN)	91-95	168	27 010	2.59	3.24	10.27	3.39	11.50	11 650
	6KK(JPN)			(59,560)	(8'6")	(10'8")	(38'8")	(11'1")	(37'7")	(25,150)
330*	9PJ(OSJ)	92-95	222	32 130	2.59	3.29	11.01	3.19	12.37	15 550
	8RL(OSJ)			(70,830)	(8'6")	(10'10")	(36'2")	(10'6")	(40'6")	(33,650)
	9NG(JPN)	92-95	222	32 130	2.59	3.29	11.01	3.19	12.37	15 550
	9PJ(JPN)			(70,830)	(8'6")	(10'10")	(36'2")	(10'6")	(40'6")	(33,650)
330L*	6SK(OSJ)	92-95	222	33 510	2.59	3.29	11.01	3.34	12.37	14 600
	9ML(OSJ)			(73,880)	(8'6")	(10'10")	(36'2")	(10'11")	(40'6")	(31,500)
	6WJ(JPN)	92-95	222	33 510	2.59	3.29	11.01	3.34	12.37	14 600
	6SK(JPN)			(70,830)	(8'6")	(10'10")	(36'2")	(10'11")	(40'6")	(31,500)

*When shipped with medium stick and bucket curled under.

**Maximum reach at ground level, one-piece boom, longest stick.

***Lift capacity at 4.6 m (15'0") over front, one-piece boom, longest stick.



HYDRAULIC EXCAVATORS (Wheel)

Model	Product Ident. No. Prefix (USA)	Years Built	Flywheel Horsepower	Approx. Operating Weight kg (lb)	Height* m (ft)	Length* m (ft)	Width m (ft)	Max. Reach** m (ft)	Lift Capacity*** kg (lb)	Standard Tire Size
206	(2RC) (3GC)	84-89	Deutz-67 Perkins-71	12 185 (26,863)	3.11 (10'2")	7.38 (24'2.5")	2.40 (7'10")	8.14 (26'9")	3360 (7400)	Dual 9.00-20 12PR
212	(3JC) (5DC)	84-89	Deutz-84 Perkins-94	13 700 (30,423)	3.15 (10'4")	8.00 (26'3")	2.49 (8'2")	9.86 (32'4")	3850 (8490)	Dual 10.00-20 12PR
212B	(3PJ)	90-95	110	14 000 (30,870)	3.04 (10'0")	8.28 (27'2")	2.49 (8'2")	9.48 (31'1")	3900 (8600)	Dual 10.00-20 12PR
214	(9MB) (1KB)	84-89	Deutz-101 Perkins-102	15 600 (34,175)	3.06 (10'0")	8.28 (27'2")	2.49 (8'2")			Dual 10.00-20 12PR
214B	4CF	87-94	110	18 700 (41,230)	3.06 (10'0")	8.28 (27'2")	2.49 (8'2")	10.41 (34'2")	4200 (9260)	Dual 10.00-20 12PR
214B FT	9NF	87-94	135	18 700 (41,230)	3.06 (10'0")	8.28 (27'2")	2.49 (8'2")	10.41 (34'2")	4200 (9260)	Dual 10.00-20 12PR
224	(2JC) (5TC)	84-89	Deutz-143 Perkins-124	19 000 (41,890)	3.42 (11'3")	8.98 (29'6")	2.49 (8'2")	10.61 (34'10")	4800 (10,600)	Dual 10.00-20 12PR

*When shipped with medium stick and bucket curled under.

**Maximum reach at ground level, one-piece boom, longest stick.

***Lift capacity at 4.6 m (15'0") over front, one-piece boom, longest stick.



5000 SERIES EXCAVATORS AND FRONT SHOVELS

Model	Product Ident. No. Prefix (USA)	Years Built	Flywheel Horsepower	Approx. Operating Weight kg (lb)	Rated* Capacity m ³ (yd ³)	Breakout Force kg (lb)	Crowd Force kg (lb)	Truck Gauge m (ft)	Max Reach* m (ft)	Max Load Height m (ft)	Max Digging Depth m (ft)
5130ME	5ZL	92-97	755	180 000 (397,000)	10.0 (13.0)	615 (138,400)	624 (140,300)	4.72 (15'6")	14.9 (48'11")	9.1 (29'10")	8.4 (27'7")
5130FS	5ZL	92-97	755	179 000 (395,000)	10.5 (13.7)	715 (161,000)	770 (173,000)	4.72 (15'6")	12.4 (40'8")	9.1 (29'10")	—

*Standard boom and stick.



LOGGING AND FOREST PRODUCT MACHINES

Model	Product Ident. No. Prefix	Year Built	Flywheel Horsepower	Overall Track Length m (ft)	Overall Length m (ft)	Overall Width m (ft)	Operating Weight kg (lb)
FB221	8XD	1986	197	4.47 (14'8")	9.78 (32'1")	3.20 (10'6")	28 180 (62,000)
FB227	10W	1983-93	135/180	4.55 (14'11")	11.88 (39'0")	3.35 (11'0")	31 769 (69,892)
DL221	8YD	1987	132	4.47 (14'8")	—	—	22 816 (50,300)
LL216	8JD	1986	128	—	10.70 to 11.23 (35'1" to 36'10")	2.64 (8'8")	17 577 (38,750)
LL228	8MD	1986	176	—	9.7 to 11.6 (32'0" to 38'0")	2.62 (8'7")	30 391 (67,000)
LL231	8PD	1986	235	5.03 (16'6")	10.6 to 11.6 (35'0" to 38'0")	3.56 (11'8")	39 146 (86,300)



WHEEL SKIDDERS

Model	Product Ident. No. Prefix	Year Built	Flywheel Horsepower kW (HP)	Operating Weight kg (lb)	Ground Clearance mm (in)	Wheel Base m (ft/in)
508 Cable	9NC	87-89	71 (95)	7770 (17,130)	521 (20.5)	2.8 (9'2")
508 Grapple	2HD	87-89	71 (95)	8766 (19,308)	521 (20.5)	2.8 (9'2")
518 FB	8ZC	86-89	96 (130)	11 612 (25,600)	587 (23.1)	3.25 (10'8")
518 PS Cable	50S	71-83	90 (120)	7718 (17,000)	505.4 (19.8976)	2895.6 (9'6")
518 PS Grapple	55U	1-80/81-83	90/97 (120/130)	9307 (20,500)	505.4 (19.8976)	2895.6 (9'6")
518 Cable	94U	3-84/85-92	90/97 (120/130)	9988 (22,000)	470 (18.5039)	3251 (10'8.4")
518 Grapple	95U	81-90	97 (130)	11 259 (24,800)	470 (18.5039)	3251 (10'8.4")
518 Series II Cable	94U	91-92	dual 97/108 (130/145)	10 260 (22,600)	470 (18.5039)	3251 (10'8.4")
518 Series II Grapple	95U	91-92	dual 97/108 (130/145)	12 031 (26,500)	470 (18.5039)	3251 (10'8.4")
518C Cable	1CL	93-95	115 (154)	11 528 (25,391)	450.7 (17.74406)	3251 (10'8.4")
518C Grapple	9HJ	93-95	115 (154)	12 587 (27,725)	463.4 (18.24406)	3251 (10'8.4")



TRACK SKIDDERS

Model	Product Ident. No. Prefix	Year Built	Flywheel Horsepower kW (HP)	Operating Weight kg (lb)	Gauge m (ft/in)
D4 TSK Series II	8ZF	90-92	78 (105)	12 909 (28,400)	2.00 (6'6")
D4 TSK Series III	7PK	92-96	78 (105)	14 000 (30,900)	2.00 (6'6")
D5H TSK Series II	7EG	92-96	97 (130)	18 800 (41,360)	2.16 (7'11")



BACKHOE LOADERS

Model	Product Ident. No. Prefix	Year Built	Flywheel Horsepower kW (HP)	Operating Weight kg (lb)	Digging Depth mm (ft/in)	GP Bucket Capacity m ³ (yd ³)	MP Bucket Capacity m ³ (yd ³)
416	5PC	85-90	46 (62)	6156 (13,574)	4420 (14'6")	0.76 (1.0)	0.76 (1.0)
416 Series II	5PC	90-92	46 (62)	6217 (13,708)	4420 (14'6")	0.76 (1.0)	0.76 (1.0)
416B	8ZK(8SG)	92-95	59 (79)	6227 (13,700)	4420 (14'6")	0.76 (1.0)	0.96 (1.25)
426	7BC	86-90	52 (70)	6549 (14,626)	4720 (15'6")	0.96 (1.25)	0.76 (1.0)
426 Series II	7BC	90-92	52 (70)	7315 (15,126)	4720 (15'6")	0.96 (1.25)	0.76 (1.0)
426B	6KL(5YJ)	92-95	59 (79)	6790 (14,970)	4720 (15'6")	0.96 (1.25)	1.04 (1.35)
428	6TC	86-90	52 (70)	6963 (15,350)	4790 (15'9")	1.0 (1.38)	0.92 (1.2)
428 Series II	6TC	90-92	52 (70)	7143 (15,750)	4750 (15'7")	1.0 (1.375)	0.92 (1.2)
428B	7EJ	92-95	60 (80)	7254 (15,992)	4810 (15'9")	1.0 (1.3)	0.92 (1.2)
436	5KF	88-90	57 (77)	6831 (15,062)	4960 (16'3")	1.0 (1.38)	0.76 (1.0)
436 Series II	5KF	90-92	57 (77)	6878 (15,166)	4950 (16'3")	1.0 (1.375)	0.76 (1.0)
436B	7FL(6MJ)	92-95	63 (84)	6857 (15,086)	4950 (16'3")	1.0 (1.38)	1.04 (1.35)
438	3DJ	88-90	63 (84)	7900 (17,420)	4810 (15'9")	1.0 (1.38)	0.92 (1.2)
438 Series II	3DJ	90-92	57 (77)	7364 (16,237)	4810 (15'9")	1.0 (1.375)	0.92 (1.2)
438B	3KK	92-95	62.7 (84)	8331 (18,367)	4870 (16'0")	1.0 (1.3)	0.92 (1.2)
446	6XF	89-95	71 (95)	8892 (19,603)	5220 (17'2")	1.1 (1.5)	1.10 (1.5)
446B			76 (102)	8890 (19,600)	5220 (17'2")	1.1 (1.5)	1.05 (1.375)



PIPELAYERS

Model	Tractor Product Ident. No. Prefix	Years Built	Engine HP	Approx. Weight kg (lb)	Counter-weight kg (lb)	Max. Lift Capacity 1.2 m (4'0") Overhang kg (lb)	Speed Range km/h (mph)		Ground Clearance mm (in)	Ground Contact m ² (sq. in.)
							Forward	Reverse		
MD6	9U39C	52-57	93	12 375 (27,820)	1590 (3500)	12 035 (26,530)	2.7—10.6 (1.7—6.6)	3.2—10.0 (2.0—6.2)	321 (13")	1.77 (2744)
561B	62A	59-66	90	14 560 (32,100)	2270 (5000)	17 500 (38,800)	2.7—10.6 (1.7—6.6)	1.8—9.9 (2.0—6.2)	267 (11")	2.02 (3130)
561B	62A	66-67	93	14 350 (31,637)	2270 (5000)	17 600 (38,800)	2.7—10.9 (1.7—6.8)	3.4—10.3 (2.1—6.4)	267 (11")	2.02 (3130)

Pipelayers (cont'd)

Model	Tractor Product Ident. No. Prefix	Years Built	Engine HP	Approx. Weight kg (lb)	Counter-weight kg (lb)	Max. Lift Capacity 1.2 m (4'0") Overhang kg (lb)	Speed Range km/h (mph)		Ground Clearance mm (in)	Ground Contact m ² (sq. in.)
							Forward	Reverse		
561C	85H	66-67	93	14 700 (32,500)	2450 (5400)	18 000 (40,000)	2.7—11.1 (1.7—6.9)	3.4—10.1 (2.1—6.3)	395 (16")	2.02 (3130)
561C	92J	67-77	105	14 700 (32,500)	2450 (5400)	18 100 (40,000)	2.7—11.1 (1.7—6.9)	3.4—10.1 (2.1—6.3)	395 (16")	2.02 (3130)
561D	54X	78-89	105	15 800 (35,000)	2990 (6600)	18 100 (40,000)	3.5—10.1 (2.2—6.3)	4.2—12.2 (2.6—7.6)	395 (16")	2.02 (3130)
571E PS	64A	61-67	160	22 680 (50,000)	2360 (5200)	27 490 (60,600)	3.7—10.3 (2.3—6.4)	4.3—12.1 (2.7—7.5)	400 (16")	3.04 (4710)
571E PS	64A	66-72	180	23 100 (51,000)	2360 (5200)	27 500 (60,600)	3.7—10.1 (2.3—6.3)	4.3—11.9 (2.7—7.4)	400 (16")	3.04 (4710)
571F	95N	72-74	180	22 800 (50,300)	4350 (9600)	27 500 (60,600)	3.5—9.7 (2.2—6.0)	4.2—11.4 (2.6—7.1)	400 (16")	3.04 (4710)
571G	916W 52D(JPN)	75-81 87-96	200 200	23 040 (50,800)	4350 (9600)	27 500 (60,600)	3.7—10.0 (2.3—6.2)	4.5—11.9 (2.8—7.9)	399 (15.7")	3.04 (4710)
MD7	17A	51-57	140	16 200 (35,815)	3400 (7500)	24 585 (54,200)	2.4—9.5 (1.5—5.9)	2.9—8.7 (1.8—5.4)	394 (16")	3.12 (4840)
572C	21A	57-61	128	26 200 (57,820)	4720 (10,405)	39 000 (86,000)	3.2—7.7 (2.0—4.8)	3.9—6.1 (2.4—3.8)	483 (19")	3.30 (5109)
572D	21A	59	140	26 500 (58,520)	4940 (10,900)	39 000 (86,000)	4.2—9.7 (2.6—6.0)	4.8—7.7 (3.0—4.8)	483 (19")	3.30 (5109)
572E PS	65A	61-69	180	28 000 (62,000)	6000 (13,000)	40 800 (90,000)	3.7—10.1 (2.3—6.3)	4.3—11.9 (2.7—7.4)	480 (19")	3.45 (5345)
572F PS	96N	70-74	180	27 600 (61,000)	6440 (14,200)	40 800 (90,000)	3.5—9.7 (2.2—6.0)	4.2—11.4 (2.6—7.1)	480 (19")	3.45 (5345)
583C	16A	55-58	190	35 440 (78,132)	8470 (18,676)	58 970 (130,000)	3.9—8.7 (2.4—5.4)	3.9—8.7 (2.4—5.4)	533 (21")	4.24 (6580)
583H TC	38A	59-60	235	38 000 (83,840)	9030 (19,900)	62 140 (137,000)	4.5—10.3 (2.8—6.4)	4.5—10.3 (2.8—6.4)	537 (22")	4.66 (7220)
583H PS	61A	60-74	191	35 600 (78,500)	8470 (18,676)	58 970 (130,000)	3.9—8.7 (2.4—5.4)	3.9—8.7 (2.4—5.4)	533 (21")	4.55 (7050)
583H PS	61A	60-67	225	38 200 (84,270)	9000 (19,900)	62 140 (137,000)	4.1—11.1 (2.5—6.9)	4.6—12.8 (8.9—8.0)	537 (22")	4.66 (7220)
583H PS	61A	61	235	38 900 (85,720)	10 400 (22,880)	62 140 (137,000)	3.9—10.1 (2.4—6.3)	4.8—12.6 (3.0—7.8)	537 (22")	4.66 (7220)
583H	61A	74	270	40 600 (89,500)	10 300 (22,700)	63 500 (140,000)	3.9—10.5 (2.4—6.5)	4.8—13.0 (3.0—8.1)	533 (21")	4.65 (7220)
583K	78V	74-89	300	40 960 (90,300)	7840 (17,290)	63 500 (140,000)	4.0—10.9 (2.5—6.8)	5.0—13.5 (3.1—8.4)	530 (21")	4.65 (7220)
594	62H	74	385	55 400 (122,000)	12 600 (27,800)	90 700 (200,000)	3.9—10.5 (2.4—6.5)	4.8—12.7 (3.0—7.9)	640 (25")	5.72 (8865)
594H	96V	74-82	410	56 065 (123,600)	12 555 (27,680)	90 700 (200,000)	4.0—10.8 (2.5—6.7)	5.0—13.2 (3.1—8.2)	630 (25")	6.48 (10,050)



WHEEL TRACTOR-SCRAPERS

Model	Product Ident. No. Prefix	Years Built	Horse-power Max/ Rated	Capacity Struck/ Heaped m³ (yd³)	Approx. Shipping Weight kg (lb)	Dimensions m (ft)				Tire Size (Standard) & ply rating Tractor & Scraper	Approx. % Weight on Drivers Loaded/ Empty	Turning Circle m (ft)
						Length	Width	Height	Width of Tread			
DW10 Tractor	1N	41-46	100/*	—	6550 (14,350)	4.57 (15'0")	2.24 (7'4")	1.93 (6'4")	1.73 (5'8")	10.0 × 20-12 18.0 × 24-16	—	—
DW10 Tractor	6V	46-47	100/*	—	6850 (15,100)	4.57 (15'0")	2.24 (7'4")	1.93 (6'4")	1.73 (5'8")	10.0 × 20-12 18.0 × 24-16	—	—
DW10 Tractor	1V	47-53	115/*	—	7540 (16,610)	4.70 (15'5")	2.34 (7'8")	1.93 (6'4")	1.79 (5'10")	12.0 × 20-14 21.0 × 25-20	—	—
DW10 & No.10 Scraper	1V 3C	47-51	115/*	6.7/8.4 (8.7/11)	15 980 (35,240)	11.23 (37'0")	3.02 (9'11")	2.69 (8'10")	1.88 (6'2")	12.0 × 20-14 21.0 × 25-20	39/44	7.92 (26'0")
DW10 & No.10 Scraper	1V 19C	52-53	115/*	5.3/6.9 (7/9)	15 130 (33,365)	10.72 (35'2")	2.87 (9'5")	2.36 (7'9")	1.80 (5'11")	12.0 × 20-14 21.0 × 25-20 16.0 × 21-20 Scraper —	42/46	11.23 (37'0")
DW15 & No.10 Scraper	45C 19C	54-55	/150	5.3/6.9 (7/9)	15 960 (35,180)	11.10 (36'5")	2.87 (9'5")	2.36 (7'9")	1.80 (5'11")	12.0 × 20-14 21.0 × 25-20 16.0 × 21-20 Scraper —	42/46	10.36 (34'0")
DW15 & No.15 Scraper	45C 4W	54-55	/150	7.7/9.2 (10/12)	9400 (20,720)	11.84 (38'10")	3.18 (10'5")	2.69 (8'10")	1.93 (6'4")	12.0 × 20-14 21.0 × 25-20	40/42	11.23 (37'0")
DW15 Tractor	45C	54-55	/150	—	9510 (20,960)	5.08 (16'8")	2.39 (7'10")	2.69 (8'10")	1.98 (6'6")	12.0 × 20-14 21.0 × 25-20	—	—
DW15C & No.15 Scraper	59C or 70C	55-57	186/*	7.7/9.5 (10/12.5)	19 220 (42,370)	11.84 (38'10")	3.18 (10'5")	2.69 (8'10")	1.98 (6'6")	12.0 × 12-14 21.0 × 25-20	40/42	10.36 (34'0")
DW15E & No. 428 Scraper	75D or 76D	57-59	200/172	10/14 (13/18)	20 280 (44,711)	12.22 (40'1")	3.30 (10'10")	3.05 (10'0")	1.98 (6'6")	12.0 × 20-14 26.5 × 25-20	37/41	—
DW15F & No. 428 Scraper	75D or 76D	58-59	200/172	10/14 (13/18)	20 280 (44,711)	12.22 (40'1")	3.30 (10'10")	3.05 (10'0")	1.98 (6'6")	12.0 × 20-14 26.5 × 25-20	37/41	—
DW20 & No. 20 Scraper	21C 11C	51-55	225/*	14/7.6 (18/23)	12 750 (28,100)	13.23 (43'5")	3.53 (11'7")	3.10 (10'2")	2.29 (7'6")	24.0 × 29-4	37/41	11.23 (37'0")
DW20 Tractor (For W20 Wagon)	6W	51-55	225/*	—	11 620 (25,610)	5.39 (17'8")	2.79 (9'2")	2.41 (7'11")	2.18 (7'2")	14.0 × 24-16 24.0 × 29-24	—	—
DW20E & No. 456 Scraper	57C 67C	55-57	300/*	14/19 (18/25)	26 040 (57,400)	13.36 (43'10")	3.58 (11'9")	3.45 (11'4")	2.24 (7'4")	14.0 × 24-16 29.5 × 29-22	34/42	11.58 (38'0")
DW20F & No. 456 Scraper	87E 88E	58-60	320/*	14/19 (18/25)	26 870 (59,240)	13.36 (43'10")	3.58 (11'9")	3.45 (11'4")	2.24 (7'4")	14.0 × 24-16 29.5 × 29-22	38/42	11.58 (38'0")
DW20G & No. 456 Scraper	87E 88E	58-60	345/*	15/21 (19.5/27)	27 200 (59,960)	13.36 (43'10")	3.58 (11'9")	3.45 (11'4")	2.24 (7'4")	14.0 × 24-16 29.5 × 29-28	38/42	11.58 (38'0")
DW20G & No. 482 Scraper	87E 88E	58-60	345/*	18.5/26 (24/34)	31 070 (68,500)	14.05 (46'1")	3.91 (12'10")	3.81 (12'6")	2.39 (7'10")	14.0 × 24-16 29.5 × 29-28	37/40	11.58 (38'0")
DW21 & No. 21 Scraper	8W 8	51-55	225/*	11.5/15 (15/20)	24 790 (54,650)	12.37 (40'7")	3.53 (11'7")	3.28 (10'9")	2.13 (7'0")	24.0 × 29-24	—	10.67 (35'0")
DW21C & No. 470 Scraper	58C 69C	55-58	300/*	14/19 (18/25)	26 610 (58,670)	12.67 (41'7")	3.58 (11'9")	3.35 (11'0")	2.24 (7'4")	29.5 × 29-22	46/33	11.00 (36'0")
DW21D & No. 470 Scraper	85E 86E	58-58	320/*	14/19 (18/25)	26 310 (58,010)	12.78 (41'11")	3.58 (11'9")	3.35 (11'0")	2.24 (7'4")	29.5 × 29-22	52/67	11.00 (36'0")
DW21G & No. 470 Scraper	85E 86E	58-60	345/*	14.9/20.6 (19.5/27)	27 210 (59,980)	12.78 (41'11")	3.58 (11'9")	3.48 (11'5")	2.24 (7'4")	29.5 × 29-28	52/67	11.00 (36'0")

*Maximum HP only available.

Wheel Tractor-Scrapers (cont'd)

Model	Product Ident. No. Prefix	Years Built	Horse-power Max/ Rated	Capacity Struck/ Heaped m³ (yd³)	Approx. Shipping Weight kg (lb)	Dimensions m (ft)				Tire Size (Standard) & ply rating Tractor & Scraper	Approx. % Weight on Drivers Loaded/ Empty	Turning Circle m (ft)
						Length	Width	Height	Width of Tread			
613A	71M	69-76	/150	8.4 (11)	13 334 (29,395)	9.67 (31'9")	2.44 (8'0")	2.85 (9'4.5")	1.89 (6'2.5")	18.0 × 25-12	49/63	9.04 (29'8")
613B	38W	76-84	/150	8.4 (11)	14 155 (31,210)	9.78 (32'1")	2.44 (8'0")	2.85 (9'4.5")	1.89 (6'2.5")	18.0 × 25-12	49/64	8.94 (29'4")
613C		84-93	175	8.4 (11)	14 670 (32,340)	10.0 (32'9")	2.44 (8'0")	3.06 (10'0")	1.89 (6'2.5")	18.00-25 16 PR (E-2)	63/49	8.9 (29'4")
615	46Z	81-87	/250	12.23 (16)	23 400 (51,590)	11.6 (38'1")	3.048 (10'0")	3.590 (11'8")	2.21 (7'3")	26.5-25, 26 PR (E-2)	65/35	9.63 (31'7")
615C		87-93	265	12.23 (16)	23 860 (52,600)	11.6 (38'1")	3.048 (10'0")	3.59 (11'9")	2.21 (7'3")	26.5-25 26 PR (E-2)	79/53	9.63 (31'7")
619B DD DD	89E 90E	59-60	/225							Turbocharged, Electric start Turbocharged, Gas start		
619C PS DD	61F 62F	60-66	280/250	10.8/14 (14/18)	21 550 (47,500)	11.05 (36'3")	3.30 (10'11")	3.76 (12'2")	2.00 (6'7")	26.5 × 29-22	55/69	9.14 (30'0")
619*	43F	64-65	/250	15.3/12.6 (20/16.5)	27 400 (60,390)	11.89 (40'0")	3.60 (11'10")	3.45 (11'4")	2.30 (7'7")	26.5 × 29-26	53/65.8	10.20 (33'6")
621	43H	65-72	/300	16.5/— (21.5/—)	28 400 (62,600)	12.00 (39'5")	3.60 (11'10")	3.45 (11'4")	2.19 (7'3")	29.5 × 29-22	53/65	11.50 (37'8")
621	23H	65-74	/300	10.6/15.3 (14/20)	24 900 (55,000)	11.60 (38'1")	3.50 (11'7")	3.40 (11'2")	2.10 (6'10")	29.5 × 29-22	55	13.00 (42'6")
621B	45P	73-86	/330	10.7/15.3 (14/20)	30 205 (66,590)	12.7 (41'7")	3.45 (11'4")	3.63 (11'11")	2.21 (7'3")	29.5-29, 28 PR (E-3)	55/70	11.10 (36'6")
621E	6AB 2PD	86-93	/330	15.3 (20)	30 480 (67,195)	12.93 (42'5")	3.47 (11'4")	3.71 (12'2")	2.21 (7'3")	33.25-29 26 PR (E-3)	68/53	10.9 (35'8")
623	52U	72-74	/300	16.8 (22)	29 900 (66,000)	11.90 (39'0")	3.50 (11'7")	3.70 (12'1")	2.20 (7'3")	29.5 × 29-28	53	13.70 (44'11")
623B	46P	73-86	/330	16.8 (22)	32 546 (71,750)	12.5 (41'1")	3.55 (11'8")	3.81 (12'6")	2.18 (7'2")	29.5-29, 28 PR (E-2)	49/63	8.90 (29'4")
623E	6CB	86-89	/330	16.8 (22)	33 317 (73,450)	12.61 (41'4")	3.55 (11'8")	3.81 (12'6")	2.21 (7'3")	29.5-29 34 PR (E-2)	52/65	10.9 (35'9")
623E	6YF	89-93	/365	17.6 (23)	35 290 (77,800)	12.61 (41'4")	3.55 (11'8")	3.94 (12'11")	2.18 (7'2")	29.5R25	66/51	10.9 (35'8")
627	54K	68-74	/450	10.6/15.3 (14/20)	29 900 (66,000)	12.00 (36'9")	3.50 (11'7")	3.60 (11'8")	2.20 (7'3")	29.5 × 29-28	49	13.30 (43'9")
627B	14S	73-86	T/225 S/225	10.7/15.3 (14/20)	34 610 (76,300)	13.3 (43'9")	3.45 (11'4")	3.63 (11'11")	2.18 (7'2")	29.5-29, 28 PR (E-3)	49/59	11.10 (36'6")
627E	6EB	86-90	T/225 S/225	10.7/15.3 (14/20)	34 670 (76,435)	12.89 (42'3")	3.47 (11'4")	3.71 (12'2")	2.21 2.18 (7'2")	33.25-29 26 PR (E-3)	59/48	10.90 (35'9")
627E	7CG	90-93	T/330 S/225	15.3 (20)	35 160 (77,500)	12.93 (42'5")	3.47 (11'4")	3.71 (12'2")	2.21 (7'3")	33.25-29 26 PR (E-3)	59/48	10.9 (35'8")
627B/PP	15S	73-86	T/225 S/225	15.3 (20)	35 660 (78,620)	14.91 (48'11")	3.45 (11'4")	3.63 (11'11")	2.18 (7'2")	29.5-29, 28 PR (E-3)	51/60	11.1 (36'6")
627E/PP	6GB	86-89	T/225 S/225	10.7/15.3 (14/20)	36 130 (79,655)	12.89 (42'3")	3.47 (11'4")	3.71 (12'2")	2.21 2.18 (7'2")	33.25-29 26 PR (E-3)	60/49	10.90 (35'9")
627E/PP	7CG	90-93	T/330 S/225	15.3 (20)	36 620 (80,735)	15.2 (49'7")	3.47 (11'4")	3.71 (12'2")	2.21 (7'3")	33.25-29 26 PR (E-3)	60/49	10.9 (35'8")

*Johnson Manufacturing Company built the J619 Elevating Scraper for Caterpillar in 1964.

Wheel Tractor-Scrapers (cont'd)

Model	Product Ident. No. Prefix	Years Built	Horse-power Max/ Rated	Capacity Struck/ Heaped m³ (yd³)	Approx. Shipping Weight kg (lb)	Dimensions m (ft)				Tire Size (Standard) & ply rating Tractor & Scraper	Approx. % Weight on Drivers Loaded/ Empty	Turning Circle m (ft)
						Length	Width	Height	Width of Tread			
630A & 482C Scraper	52F	60-62	420/335	21/27 (27/35)	35 830 (79,000)	14.63 (48'0")	3.91 (12'10")	4.01 (13'2")	2.39 (7'10") Scraper	16.0 × 25-16 29.5 × 35-28 33.5 × 33-26	37/42	11.89 (39'0")
630A	52F	60-62	420/335	16/21.4 (21/28)	31 430 (69,300)	13.82 (45'4")	3.58 (11'9")	3.73 (12'3")	2.21 (7'3")	16.0 × 25-16 29.5 × 35-28	39/45	11.89 (39'0")
630B	14G	62-63	420/335	16/23 (21/30)	33 520 (73,900)	14.12 (46'4")	3.81 (12'6")	3.71 (12'2")	2.41 (7'11")	16.0-25, 16 29.5-35, 28	38/42	13.36 (43'10")
630B	14G	63-66	400/360	16/23 (21/30)	33 570 (74,000)	14.30 (46'11")	3.81 (12'6")	3.94 (12'11")	2.41 (7'11")	16.0-25, 16 29.5-35, 34	37/42	13.36 (43'10")
630B	10G	62-69	/400	16/23 (21/30)	35 750 (78,800)	14.35 (47'1")	3.81 (12'6")	3.94 (12'11")	2.40 (7'10")	16.0-25, 16 29.5-35, 34	38/44	13.36 (43'10")
631A	51F	60-62	420/335	16/21.4 (21/28)	30 250 (66,700)	12.88 (42'3")	3.58 (11'9")	3.56 (11'8")	2.21 (7'3")	29.5-35, 28	54/69	11.00 (36'0")
631B	13G	62-62	420/335	16/23 (21/30)	31 620 (69,700)	13.05 (42'10")	3.81 (12'6")	3.45 (11'5")	2.39 (7'10")	29.5-35, 28	51/67	11.31 (37'5")
631B	13G	62-66	420/360	16/23 (21/30)	31 840 (70,200)	13.29 (43'7")	3.81 (12'6")	3.63 (11'11")	2.41 (7'11")	29.5-35, 34	51/67	11.31 (37'5")
631C	67M	69-75	/415	16/23 (21/30)	36 350 (80,150)	13.54 (44'5")	3.45 (11'4")	3.91 (12'10")	2.39 (7'10")	29.5-35, 34	53/69	11.45 (37'7")
631D	24W	75-85	/450	16/23.7 (21/31)	42 370 (93,410)	14.25 (46'9")	3.96 (13'0")	4.17 (13'8")	2.46 (8'1")	33.25-35, 38 PR (E-3)	/69	12.2 (40'1")
631E	1AB	85-91	473/450	16.1/23.7 (21/31)	43 365 (95,600)	14.28 (46'10")	3.94 (12'11")	4.29 (14'1")	2.46 (8'1")	37.25-35, 30	53/67	12.2 (40'1")
632	14G	62-63	420/335	21.4/29 (28/38)	37 650 (83,000)	15.21 (49'11")	4.04 (13'3")	4.00 (13'1")	2.44 (8'0")	16.0-25, 16 29.5-35, 34	36/40	13.36 (43'10")
632	14G	63-66	420/360	21.4/29 (28/38)	39 420 (86,910)	15.30 (50'2")	4.04 (13'3")	4.00 (13'1")	2.44 (8'0")	16.0-25, 16 29.5-35, 34	41/62	13.36 (43'10")
633C	66M	69-75	/415	24.5 (32)	41 750 (92,050)	13.36 (43'10")	3.45 (11'4")	3.96 (13'0")	2.39 (7'10")	33.2-35, 32	53/67	11.78 (38'8")
633D	25W	75-85	450	26 (34)	47 570 (104,870)	14.40 (47'3")	3.96 (13'0")	4.24 (13'11")	2.46 (8'1")	33.25-35, 38 PR (E-3)	67	12.4 (40'7")
633E		85-95	475	26 (34)	50 800 (112,000)	14.40 (47'3")	3.96 (13'0")	4.24 (13'11")	2.46 (8'1")	37.25R35	64/36	13.15 (43'2")
637	65M	70-75	/*640	16/23 (21/30)	41 300 (91,050)	13.65 (44'9.5")	3.45 (11'4")	3.93 (12'11")	2.39 (7'10")	33.25-35, 32	51/62	11.68 (38'4")
637/PP	79P	70-75	/*640	16/23 (21/30)	43 700 (96,350)	15.82 (51'11")	3.45 (11'4")	3.93 (12'11")	2.39 (7'10")	33.25-35, 32	51/63	11.68 (38'4")
637D	26W	75-85	450	16.1/23.7 (21/31)	46 987 (103,590)	14.8 (48'8")	3.96 (13'0")	4.17 (13'8")	2.46 (8'1")	33.25-35, 38 PR (E-3)	50/61	12.2 (40'1")
637D/PP	27W	75-85	450	16.1/23.7 (21/31)	48 531 (106,990)	14.8 (48'8")	3.96 (13'0")	4.17 (13'8")	2.46 (8'1")	33.25-35, 38 PR (E-3)	50/61	12.2 (40'1")
637E	1FB	85-91	473/450	16.1/23.7 (21/31)	49 940 (110,100)	14.28 (46'10")	3.94 (12'11")	4.29 (14'1")	2.46 (8'1")	37.25-35, 30	49/59	12.2 (40'1")
637E/PP	1FB	85-91	473/450	16.1/23.7 (21/31)	51 485 (113,500)	15.88 (52'1")	3.94 (12'11")	4.29 (14'1")	2.46 (8'1")	37.25-35, 30	50/60	12.2 (40'1")
639D	99X	79-84	/450	26 (34)	55 030 (121,318)	14.53 (47'8")	3.96 (13'0")	4.06 (13'4")	2.46 (8'1")	37.25-35, 42 37.25-35, 42	51/59	12.4 (40'7")
641	64F	62-65	560/450	21.4/29 (28/38)	43 200 (95,300)	14.73 (48'4")	4.04 (13'3")	4.00 (13'1")	2.44 (8'0")	33.5-39, 38	51/66	12.68 (41'7")
641B	65K	69-81	/550	21.4/29 (28/38)	53 070 (117,000)	14.96 (49'1")	4.04 (13'3")	4.24 (13'11")	2.55 (8'4")	37.5-39, 36	54/69	13.00 (42'9")

*Maximum HP only available.

Wheel Tractor-Scrapers (cont'd)

Model	Product Ident. No. Prefix	Years Built	Horse-power Max/ Rated	Capacity Struck/ Heaped m ³ (yd ³)	Approx. Shipping Weight kg (lb)	Dimensions m (ft)				Tire Size (Standard) & ply rating Tractor & Scraper	Approx. % Weight on Drivers Loaded/ Empty	Turning Circle m (ft)
						Length	Width	Height	Width of Tread			
650	63F	62-64	560/450	24.5/33.6 (32/44)	45 130 (99,500)	16.31 (53'6")	4.24 (13'11")	4.01 (13'2")	2.54 (8'4")S	18.0-25, 20 33.5-39, 32 37.5-39, 36	36/40	13.87 (45'6")
650B	22G	62-72	/550	24.5/33.6 (32/44)	46 100 (101,700)	17.00 (55'10")	3.80 (12'6")	4.30 (14'1")	2.65 (8'9")S	18.0-25, 20 37.5-39, 28 37.5-30, 36	52/65	14.00 (46'0")
651	33G	62-68	560/450	24.5/33.6 (32/44)	43 730 (96,400)	14.93 (49'0")	4.24 (13'11")	4.01 (13'2")	2.54 (8'4")	37.5-39, 36	51/65	13.29 (43'7")
651B	67K	69-84	/550	24.5/33.6 (32/44)	56 340 (124,200)	15.34 (51'4")	4.32 (14'2")	4.29 (14'1")	2.72 (8'11")S	37.5-39, 36 37.5-39, 36	52/67	13.5 (44'2")
657	31G	62-68	T560/450 S420/335	24.5/33.6 (32/44)	56 550 (124,700)	15.39 (50'6")	4.24 (13'11")	4.09 (13'5")	2.62 (8'7")	37.5-39, 4	48/56	13.29 (43'7")
657	46M	68-69	T—/500 S420/360	24.5/33.6 (32/44)	56 820 (125,155)	15.39 (50'6")	4.24 (13'11")	4.09 (13'5")	2.67 (8'8")	37.5-39, 44	48/55	14.57 (47'10")
657B	68K	69-84	T—/550 S—/400	24.5/33.6 (32/44)	63 100 (139,100)	15.7 (51'8")	4.32 (14'2")	4.21 (13'10")	2.67 (8'9")S	37.5-39, 44 37.5-39, 44	49/59	13.7 (45'1")
660	90F	62-64	560/450	30.6/41.3 (40/54)	49 130 (108,300)	17.04 (55'11")	4.24 (13'11")	4.37 (14'4")	2.59 (8'6")	18.0 × 25-20 37.5 × 39-28 37.5 × 51-36	37/41	13.87 (45'6")
660B	58K	70-78	/550	30.6/41.3 (40/54)	59 875 (132,000)	17.27 (56'8")	3.81 (14'2")	4.37 (14'4")	Scraper—	18.0 × 25-20 37.5 × 39-28	41/46	14.00 (46'0")
666	77F	63-69	F460/450 R420/335	30.6/41.3 (40/54)	56 700 (125,000)	17.04 (55'11")	4.24 (13'11")	4.37 (14'4")	2.59 (8'6")	18.0 × 25-20 37.5 × 39-28 37.5 × 51-36	34/35*	13.87 (45'6")
666	64H	67-69	F—/500 R420/360	30.6/41.3 (40/54)	58 800 (129,645)	17.27 (56'8")	4.24 (13'11")	4.37 (14'4")	2.59 (8'6")	18.0 × 25-20 37.5 × 39-28 37.5 × 51-51	35/36*	13.87 (45'6")
666B	66K	69-78	/950	30.6/41.3 (40/54)	67 630 (149,500)	17.27 (56'8")	4.31 (14'4")	4.37 (14'4")	Scraper— (8'9")	18.0 × 25-20 37.5 × 39-28	39/36	14.00 (46'0")

*Tractor & Scraper Combined.



TRACTOR-TOWED SCRAPERS

Model	Product Ident. No. Prefix	Years Built	Capacity Struck/ Heaped m ³ (yd ³)	Weight kg (lb)	Width m (ft)	Length m (ft)	Height m (ft)	Width of Cut m (ft)
40	1W	49-59	2.8/3.4 (3.6/4.5)	3348 (7380)	2.27 (7'6")	6.40 (21'0")	1.68 (5'6")	1.82 (6'0")
60	1D	47-53	4.6/6.1 (6.0/8.0)	5579 (12,300)	2.65 (8'9")	8.43 (27'8")	2.36 (7'9")	2.13 (7'0")
60	2W	52-72	5.4/7.0 (7.0/9.0)	6100 (13,500)	2.85 (9'5")	8.52 (28'3")	2.36 (7'9")	2.40 (7'11")
70	8C	46-53	6.7/8.4 (8.7/11.0)	8527 (18,800)	3.02 (10'0")	9.50 (31'2")	2.56 (8'5")	2.43 (8'0")
70	3W	51-57	7.8/9.9 (10.2/13.0)	9140 (20,150)	3.16 (10'5")	9.53 (31'4")	2.61 (8'7")	2.59 (8'6")
80	2D	46-52	10.3/13.8 (13.5/18.0)	11 793 (26,000)	3.38 (11'2")	10.82 (35'6")	2.92 (9'7")	2.74 (9'0")
80	5W	50-56	11.5/15.3 (15.0/20.0)	13 533 (29,836)	3.50 (11'6")	10.92 (35'0")	3.09 (10'2")	2.89 (9'6")

Former Models

Wheel Tractor-Scrapers Construction & Mining Trucks/Tractors

Tractor-Towed Scrapers (cont'd)

Model	Product Ident. No. Prefix	Years Built	Capacity Struck/ Heaped m ³ (yd ³)	Weight kg (lb)	Width m (ft)	Length m (ft)	Height m (ft)	Width of Cut m (ft)
90	9V	51-55	16.2/20.6 (21.2/27.0)	17 208 (37,937)	3.65 (12'0")	12.19 (40'0")	3.20 (10'6")	3.04 (10'0")
435C	45D	56-61	9.9/13.8 (13.0/18.0)	10 659 (23,500)	3.28 (10'10")	10.16 (33'4")	3.01 (9'11")	2.84 (9'4")
435D	45D	59-61	11.5/14.5 (15.0/19.0)	11 521 (25,400)	3.29 (10'10")	10.16 (33'4")	3.01 (9'11")	2.84 (9'4")
435E	85F	61-72	9.2/13.0 (12.0/17.0)	10 400 (22,900)	3.29 (10'10")	10.06 (33'1")	3.07 (10'1")	2.84 (9'4")
435F	45D	62-72	10.7/13.8 (14.0/18.0)	11 300 (24,900)	3.29 (10'10")	10.06 (33'1")	3.02 (9'11")	2.84 (9'4")
435G	27G	63-73	9.2/13.0 (12.0/17.0)	10 400 (22,900)	3.27 (10'9")	10.08 (33'1")	2.97 (9'9")	2.84 (9'4")
463	62C	55-60	13.8/29.1 (18.0/25.0)	14 061 (31,000)	3.58 (11'9")	11.58 (38'0")	3.39 (11'2")	3.15 (10'4")
463C	62C	59-60	16.8/21.4 (22.0/28.0)	15 785 (34,800)	3.58 (11'9")	11.58 (38'0")	3.39 (11'2")	3.15 (10'4")
463E	86F	60-71	13.8/20.0 (18.0/26.0)	15 600 (34,400)	3.58 (11'9")	11.65 (38'3")	3.28 (10'10")	3.15 (10'4")
463F	62C	63-71	16.0/21.4 (21.0/28.0)	15 700 (34,600)	3.58 (11'9")	11.65 (38'3")	3.28 (10'10")	3.15 (10'4")
463G	28G	63-71	13.8/20.0 (18.0/26.0)	13 200 (29,200)	3.58 (11'9")	11.52 (37'10")	3.14 (10'4")	3.15 (10'4")
491	98C	56-64	20.6/26.0 (27.0/34.0)	16 964 (37,400)	3.65 (12'0")	12.13 (39'10")	3.96 (13'0")	3.16 (10'5")
491B	9A	61-63	20.6/26.8 (27.0/35.0)	20 902 (46,060)	3.91 (12'10")	12.49 (41'0")	3.96 (13'0")	3.30 (10'10")
491C	47E	63-70	20.6/26.8 (27.0/35.0)	21 600 (47,500)	3.91 (12'10")	12.64 (41'6")	3.96 (13'0")	3.30 (10'10")



CONSTRUCTION & MINING TRUCKS/TRACTORS

Model	Product Ident. No. Prefix	Years Built	Flywheel Kilowatts (Horsepower)	Capacity Metric Tons (U.S. Tons)	Approx. Weight kg (lb)	Dimensions m (ft)					Tire Size	
						Width	Length	Height	Loading Height	Dumping Height (55°)		Turning Circle
768B	79S	71-78	309 (415)	— —	22 000 (48,500)	3.61 (11'10")	6.55 (21'6")	3.48 (11'5")	— —	— —	18.0	18.00 × 33—24 PR
768C	02X	78-95	336 (450)	— —	24 624 (54,285)	4.70 (15'5")	8.00 (26'3")	3.56 (11'8")	— —	— —	18.5 (60'8")	18.00R33 E-4
769	99F	62-67	298 (400)	31.8 (35.0)	25 365 (55,870)	3.63 (11'11")	7.64 (25'1")	4.05 (13'4")	3.07 (10'1")	7.18 (26'7")	16.5 (54'5")	18.00 × 25—32 PR
769B	99F	67-78	309 (415)	32.0 (35.0)	28 000 (61,800)	3.64 (11'11.5")	7.85 (25'9")	3.89 (12'9")	3.15 (10'4")	7.24 (23'9")	18.0 (59'1")	18.00 × 25—32 PR E-3
769C	01X	78-95	336 (450)	36.9 (40.6)	30 675 (67,855)	4.70 (15'5")	8.00 (26'3")	3.85 (12'8")	3.24 (10'7")	7.68 (25'2")	18.5 (60'8")	18.00R33 E-4
771C	3BJ	92-95	336 (450)	40.0 (44.0)	34 170 (75,345)	4.74 (15'7")	8.20 (26'11")	4.00 (13'1")	3.30 (10'10")	7.68 (25'2")	18.5 (60'8")	18.00R33 E-4
772	80S	71-78	447 (600)	— —	32 100 (70,800)	4.06 (13'4")	7.11 (23'4")	3.68 (12'1")	— —	— —	22.1 (72'6")	24.00 × 35—36 PR
772B	64W	78-95	485 (650)	— —	32 909 (72,550)	4.86 (15'11")	9.12 (29'11")	4.52 (14'10")	— —	— —	23.5 (77'0")	24.00R35 E-4

Construction & Mining Trucks/Tractors (cont'd)

Model	Product Ident. No. Prefix	Years Built	Flywheel Kilowatts (Horsepower)	Capacity Metric Tons (U.S. Tons)	Approx. Weight kg (lb)	Dimensions m (ft)					Tire Size	
						Width	Length	Height	Loading Height	Dumping Height (55°)		Turning Circle
773	63G	70-78	447 (600)	45.4 (50.0)	37 800 (83,360)	4.06 (13'4")	8.71 (28'7")	4.27 (14'0")	3.61 (11'10")	8.36 (27'5")	22.1 (72'6")	21.00 × 35—32 PR E-3
773B	63W	78-95	485 (650)	54.3 (59.8)	38 321 (84,500)	4.86 (15'11")	9.12 (29'11")	4.31 (14'2")	3.77 (12'5")	8.72 (28'7")	23.5 (77'0")	24.00R35 E-4
775B	7XJ	92-95	485 (650)	59.5 (65.5)	42 324 (93,325)	4.91 (16'2")	9.33 (30'7")	4.31 (14'2")	3.86 (12'8")	8.72 (28'8")	23.5 (77'7")	24.00R35 E-4
776	14H	75-84	649 (870)	—	49 686 (109,540)	3.51 (11'6")	8.06 (26'5.5")	3.40 (11'2")	—	—	26.8 (88'0")	27.00 × 49—36 PR E-3
776B	6JC	84-92	649 (870)	—	49 896 (110,000)	3.51 (11'6")	8.06 (26'6")	3.40 (11'2")	—	—	25.8 (84'6")	27.00 × 49—36 PR E-3
776C	2TK	92-96	649 (870)	—	49 896 (110,000)	3.51 (11'6")	8.06 (26'5.5")	4.55 (14'11")	—	—	25.8 (84'6")	27.00R49
777	84A	74-84	649 (870)	77.1 (85.0)	58 886 (129,820)	5.463 (17'11")	9.78 (32'1")	4.90 (16'1")	4.14 (13'7")	9.29 (30'6")	26.8 (88'0")	24.00 × 49—42 PR E-3
777B	4YC	84-92	649 (870)	86.2 (95.0)	60 055 (132,422)	5.463 (17'11")	9.79 (32'1")	4.97 (16'4")	4.17 (13'8")	9.42 (30'11")	25.8 (84'6")	24.00 × 49—48 PR E-3
777C	4XJ	92-96	649 (870)	86.2 (95.0)	61 790 (136,227)	5.463 (17'11")	9.79 (32'1")	4.97 (16'4")	4.17 (13'8")	9.42 (30'11")	25.8 (84'6")	27.00R49
785	8GB	85-92	962 (1290)	136.0 (150.0)	96 353 (212,458)	6.64 (21'9")	11.02 (36'2")	5.77 (18'11")	4.98 (16'4")	11.20 (36'9")	30.5 (100'4")	33.00 × 51
789	92C	86-92	1272 (1705)	177.0 (195.0)	121 922 (268,837)	7.67 (25'2")	12.18 (39'11")	6.15 (20'2")	5.21 (17'1")	11.91 (39'1")	30.2 (99'2")	37.00R57
793	3SJ	90-92	1534 (2057)	218.0 (240.0)	143 564 (323,709)	7.60 (24'11")	12.86 (42'3")	6.43 (21'1")	5.86 (19'3")	13.21 (43'4")	30.2 (99'2")	40.00-57
793B	1HL	92-96	1534 (2057)	218.0 (240.0)	143 564 (323,709)	7.60 (24'11")	12.86 (42'3")	6.43 (21'1")	5.86 (19'3")	13.21 (43'4")	30.2 (99'2")	40.00R57



ARTICULATED TRUCKS

Model	Product Ident. No. Prefix	Years Built	Flywheel Kilowatts (Horsepower)	Capacity Metric Tons (U.S. Tons)	Approx. Weight kg (lb)	Dimensions m (ft)					Tire Size	
						Width	Length	Height	Loading Height	Dumping Height (55°)		Turning Circle
D20D	9MG	92-94	134 (180)	18.0 (20.0)	15 000 (33,070)	2.75 (9'0")	8.43 (27'8")	3.30 (10'10")	2.40 (7'11")	5.0 (16'5")	7.25 (24'0")	23.5R25
D22	*	80-82	175 (235)	20.0 (22.0)	17 700 (39,000)	3.00 (9'10")	7.85 (25'9")	3.09 (10'2")	2.44 (8'0")	5.03 (16'6")	7.87 (25'10")	26.5R25
D25	*	80	175 (235)	22.7 (25.0)	17 300 (38,000)	3.00 (9'10")	7.85 (25'9")	3.09 (10'2")	2.44 (8'0")	5.03 (16'6")	7.87 (25'10")	26.5R25
D25B	*	80-83	190 (255)	22.7 (25.0)	17 900 (39,400)	3.00 (9'10")	7.99 (26'2")	3.25 (10'8")	2.44 (8'0")	5.03 (16'6")	7.87 (25'10")	26.5R25
D25C	9YC	85-89	194 (260)	22.7 (25.0)	19 233 (42,400)	3.00 (9'10")	8.73 (28'8")	3.27 (10'9")	2.56 (8'5")	5.28 (17'4")	16.14 (52'11")	26.5R25
D30C	7ZC	85-89	194 (260)	27.2 (30.0)	21 320 (47,000)	3.30 (10'10")	8.86 (29'1")	3.33 (10'11")	2.85 (9'4")	5.46 (17'11")	16.33 (53'7")	29.5R25

*Information not available — DJB models.

Articulated Trucks (cont'd)

Model	Product Ident. No. Prefix	Years Built	Flywheel Kilowatts (Horsepower)	Capacity Metric Tons (U.S. Tons)	Approx. Weight kg (lb)	Dumping						Tire Size
						Width	Length	Height	Loading Height	Height (55°)	Turning Circle	
D35	*	81-83	190 (255)	31.8 (35.0)	20 000 (44,000)	3.27 (10'9")	8.44 (27'8")	3.25 (10'8")	2.91 (9'7")	5.46 (17'11")	7.87 (25'10")	26.5R25 33.25R29
D35C	2GD	85-89	194 (260)	31.8 (35.0)	23 860 (52,600)	3.50 (11'6")	9.44 (31'0")	3.34 (10'11")	2.93 (9'7")	5.32 (17'5")	16.00 (52'5")	Front 29.5R25 Rear 33.5R29
D35 HP	3FD	85-89	287 (385)	31.8 (35.0)	24 950 (55,000)	3.50 (11'6")	9.80 (32'2")	3.51 (11'6")	2.93 (9'7")	5.32 (17'5")	15.78 (51'9")	Front 29.5R25 Rear 33.5R29
D40D	2JJ	89-94	287 (385)	36.3 (40.0)	28 027 (61,800)	3.48 (11'5")	9.76 (32'0")	3.56 (11'8")	3.20 (10'7")	6.00 (19'8")	7.90 (25'11")	Front 29.5R25 Rear 33.25R29
D44	*	81-86	336 (450)	40.0 (44.0)	28 000 (61,600)	3.66 (12'0")	10.05 (33'0")	3.86 (12'8")	2.90 (9'6")	6.35 (20'10")	9.96 (32'8")	33.25R29
D44B	4LD	86-87	343 (460)	40.0 (44.0)	32 296 (71,200)	3.73 (12'3")	10.05 (33'0")	3.98 (13'1")	2.98 (9'9")	6.40 (21'0")	9.08 (29'9")	33.25R29
D250	*	75-78	175 (235)	25.0 (27.5)	18 500 (40,700)	2.66 (8'9")	8.82 (29'0")	3.04 (10'0")	2.61 (8'7")	6.22 (20'5")	7.67 (25'2")	23.5R25
D250B	5WD	85-91	163 (218)	22.7 (25.0)	17 963 (39,600)	2.50 (8'2.5")	9.60 (31'8.5")	3.18 (10'5")	2.55 (8'4.5")	6.23 (20'5")	7.65 (25'1")	20.5R25
D250D	6NG	92-94	160 (214)	22.8 (25.0)	17 300 (38,150)	2.50 (8'2")	9.60 (31'6")	3.21 (10'7")	2.59 (8'6")	6.22 (20'5")	7.61 (25'0")	20.5R25
D275	*	78-80	175 (235)	25.0 (27.5)	18 700 (41,000)	2.66 (8'9")	8.82 (29'0")	3.17 (10'7")	2.61 (8'7")	6.22 (20'5")	7.75 (25'3")	23.5R25
D275B	*	80-82	190 (255)	25.0 (27.5)	19 200 (42,400)	2.66 (8'9")	8.96 (29'5")	3.21 (10'7")	2.61 (8'7")	6.22 (20'5")	7.75 (25'5")	23.5R25
D300	*	76-78	190 (255)	30.0 (33.0)	19 500 (42,900)	2.80 (9'2")	8.82 (29'0")	3.04 (10'0")	2.68 (8'10")	6.22 (20'5")	7.67 (25'2")	23.5R25
D300B	4SD	85-91	194 (260)	27.2 (30.0)	19 800 (43,520)	2.50 (8'2.5")	9.60 (31'8.5")	3.18 (10'5")	2.55 (8'4.5")	6.23 (20'5")	7.76 (25'6")	23.5R25
D300D	5MG	92-95	213 (285)	27.2 (30.0)	20 680 (45,600)	2.88 (9'6")	9.87 (32'5")	3.28 (10'9")	2.66 (8'9")	6.42 (21'1")	7.76 (25'5")	23.5R25
D330	*	78-80	190 (255)	30.0 (33.0)	20 000 (43,000)	2.80 (9'2")	8.82 (28'11")	3.17 (10'5")	2.68 (8'9")	6.22 (20'5")	7.80 (25'7")	23.5R25
D330B	*	80-83	190 (255)	30.0 (33.0)	20 200 (44,400)	2.76 (9'1")	9.08 (29'9")	3.25 (10'8")	2.68 (8'9")	6.33 (20'9")	7.92 (26'0")	23.5R25
D350	*	78-80	190 (255)	31.8 (35.0)	21 000 (46,000)	3.00 (9'10")	8.95 (29'4")	3.21 (10'7")	2.82 (9'3")	6.35 (20'10")	7.95 (26'1")	26.5R25
D350B	*	80-83	190 (255)	31.8 (35.0)	21 400 (47,200)	3.00 (9'10")	9.09 (29'10")	3.25 (10'8")	2.85 (9'4")	6.40 (21'0")	7.95 (26'1")	26.5R25
D350C	8XC	85-89	194 (260)	31.8 (35.0)	23 315 (51,400)	3.00 (9'10")	9.93 (32'7")	3.27 (10'9")	2.91 (9'6")	6.52 (21'5")	16.16 (53'0")	26.5R25
D350D	9RF	89-94	213 (285)	31.8 (35.0)	24 595 (54,221)	3.00 (9'10")	9.95 (32'7")	3.34 (11'0")	2.93 (9'7")	6.52 (21'5")	16.06 (52'8")	26.5R25
D400	IMD	85-89	287 (385)	36.3 (40.0)	25 765 (56,800)	3.00 (9'10")	10.42 (34'2")	3.45 (11'4")	3.00 (9'10")	6.53 (21'5")	16.07 (52'9")	26.5R25
D400D	8TF	89-95	287 (385)	36.3 (40.0)	28 027 (61,800)	3.30 (10'8")	10.62 (34'10")	3.56 (11'8")	2.98 (9'9")	6.60 (21'8")	8.26 (27'2")	29.5R25
D550	*	78-86	336 (450)	50.0 (55.0)	37 800 (83,400)	3.66 (12'0")	11.35 (37'3")	3.86 (12'8")	3.30 (10'10")	7.83 (25'8")	9.65 (31'8")	33.25R29
D550B	8SD	86-87	343 (460)	50.0 (55.0)	40 370 (89,000)	3.72 (12'2.5")	11.74 (38'6")	3.97 (13'0")	3.22 (10'6")	8.28 (27'2")	8.73 (28'8")	33.25R29

*Information not available — DJB models.



WHEEL TRACTORS

Model	Product Ident. No. Prefix	Years Built	Flywheel Kilowatts (Horsepower)	Approx. Oper. Wt. kg (lb)	Length (Dozer on ground)					Maximum Speeds		
					Tread m (ft)	Wheelbase m (ft)	Ground Clearance mm (in)	Transmission	Fwd. km/h (mph)	Rev. km/h (mph)		
814B	90P	70-81	127 (170)	18 780 (41,400)	6.49 (21'3")	2.16 (7'1")	3.10 (10'2")	356 (14")	PS 4F-4R	32.7 (20.3)	39.3 (24.4)	*
814B			161 (216)	20 927 (46,137)	6.82 (22'5")			459 (18'0")		29.9 (18.6)		*
824	29G	63-65	224 (300)	31 700 (70,000)	7.04 (23'1")	2.37 (7'10")	3.35 (11'8")	470 (18.2")	PS 3F-3R	34.1 (21.2)	34.1 (21.2)	
824B	36H	65-78	224 (300)	33 330 (73,480)	7.40 (24'3.5")	2.32 (7'7.5")	3.55 (11'8")	490 (19.4")	PS 3F-3R	29.8 (18.5)	29.8 (18.5)	
824C			235 (315)	30 380 (66,975)	7.69 (25'2")			477 (18'8")		33.2 (20.6)		
834	43E	63-74	298 (400)	40 300 (88,800)	7.75 (25'5")	2.54 (8'4")	3.80 (12'6")	510 (20.0")	PS 3F-3R	32.8 (20.4)	35.7 (22.2)	



COMPACTORS

Model	Product Ident. No. Prefix	Years Built	Flywheel Kilowatts (Horsepower)	Approx. Oper. Wt. kg (lb)	Drum Width m (ft)	Articulated Steering Angle, Maximum	Transmission	Maximum Speeds		
								Fwd. km/h (mph)	Rev. km/h (mph)	
815	91P	70-81	127 (170)	17 300 (38,200)	0.97 (3'2")	44° Either Side	Power Shift 4F-4R	30.1 (18.7)	35.7 (22.2)	*
815B			161 (216)	20 035 (44,175)						*
816	57U	72-81	127 (170)	18 550 (40,900)	1.02 (3'4")	44° Either Side	Power Shift 4F-4R	30.1 (18.6)	35.7 (22.4)	**
816B			161 (216)	20 628 (45,477)						**
825B	43N	70-78	224 (300)	30 075 (66,300)	1.13 (3'8.5")	44° Either Side	Power Shift	29.8 (18.5)	29.8 (18.5)	
835	44N	70-74	298 (400)	35 900 (79,100)	1.22 (4'0")	44° Either Side	Power Shift 3F-3R	32.2 (20.0)	34.8 (21.6)	

*Turbocharged, Articulated Steering.

**Turbocharged, ROPS Cab, Sleeve Metering Fuel System.



WHEEL LOADERS

Model	Product Ident. No. Prefix	Years Built	Flywheel Horsepower	Approx. Shipping Wt. kg (lb)	Rated Capacity m ³ (yd ³)	Breakout Force kg (lb)	Width Over Tires m (ft)	Ground Clearance mm (in)	Max. Reach at max height mm (ft)	Dump Clearance at max height m (ft)	Maximum Speeds km/h (mph)		Remarks
											Fwd.	Rev.	
910	80V	73-79	65	6100 (13,400)	1.0 (1.25)	4530 (10,000)	2.07 (6'10")	405 (16")	860 (2'10")	2.46 (8'1")	24.1 (15.0)	10.6 (6.6)	
910	40Y	79-89	65	6658 (14,679)	1.0 (1.25)	5838 (12,870)	2.07 (6'10")	405 (16")	930 (3'0.6")	2.40 (7'10")	23.9 (14.8)	10.6 (6.6)	
910	41Y	79-89	65	6658 (14,679)	1.0 (1.25)	5838 (12,870)	2.07 (6'10")	405 (16")	930 (3'0.6")	2.40 (7'10")	23.5 (14.6)	24.9 (15.5)	
910E	1SF	89-92	78	7298 (16,062)	1.3 (1.7)	6503 (14,339)	2.15 (7'0")	343 (13.5")	1000 (3'3.4")	2.57 (8'5")	34.0 (21.1)	22.4 (13.9)	3114 Engine Z Bar Linkage
910F	1SF	92-95	80	7009 (15,452)	1.3 (1.7)	6443 (14,207)	2.15 (7'0")	370 (14.6")	981 (3'3")	2.60 (8'6")	34.0 (21.1)	22.4 (13.9)	3114 Engine Z Bar Linkage
916	2XB	86-92	85	8554 (18,857)	1.4 (1.75)	9124 (20,115)	2.33 (7'8")	322 (12.7")	926 (3'0.5")	2.65 (8'9")	24.8 (15.4)	25.0 (15.5)	3204 Engine Z Bar Linkage
918F	3TJ	92-94	98	8973 (19,785)	1.5 (2.0)	9795 (21,598)	2.33 (91.6")	318 (1'1")	802 (2'8")	2.78 (9'1")	37.0 (23.0)	24.5 (15.2)	3114 Engine Z Bar Linkage
920	62K	69-84	80	8440 (18,600)	1.2 (1.5)	7901 (17,419)	2.16 (7'1")	335 (13")	740 (2'5")	2.77 (9'1")	43.8 (27.2)	23.2 (14.4)	
922A	59A	60-62	80	7350 (16,200)	0.93 (1.25)	6850 (15,100)	2.12 (7'0")	368 (15")	655 (2'2")	2.60 (8'7")	30.4 (18.9)	32.8 (20.4)	
922B	88J	62-68	80	7670 (16,900)	1.15 (1.50)	9000 (19,900)	2.25 (7'5")	390 (16")	680 (2'3")	2.60 (8'7")	33.6 (20.9)	42.9 (26.7)	
926	94Z	84-87	105	8800 (19,400)	1.21 (1.75)	5070 (11,179)	2.33 (7'8")	341 (13.5")	924 (3'0")	2.67 (8'9")	30.3 (18.8)	32.3 (20.0)	
926E	94Z	87-92	110	9432 (20,794)	1.7 (2.25)	10 044 (22,143)	2.33 (7'8")	341 (13.5")	1003 (3'3.5")	2.75 (9'0")	34.2 (21.2)	36.8 (22.9)	3204 Engine Z Bar Linkage
928F	2XL	93-96	120	10 870 (23,920)	2.1 (2.75)	10 090 (22,200)	2.43 (8'0")	318 (13")	956 (3'2")	2.74 (9'0")	36.5 (22.6)	21.1 (13.1)	3116 Engine Z Bar Linkage
930	41K	68-85	100	9660 (21,300)	1.7 (2.25)	7900 (17,410)	2.39 (7'10")	348 (13.7")	1350 (3'9")	2.79 (9'2")	44.2 (27.5)	23.3 (14.5)	3304 Engine Z Bar Linkage
936	33Z	83-87	125	11 884 (26,200)	2.1 (2.75)	12 514 (28,708)	2.56 (8'4.5")	329 (13")	1055 (3'0")	2.80 (9'2")	34.4 (21.4)	38.4 (23.9)	
936E	33Z	87-92	135	12 300 (27,000)	2.3 (3.00)	12 920 (28,483)	2.56 (8'5")	379 (14.9")	1026 (2'11")	2.87 (9'2")	40.6 (25.2)	45.3 (28.2)	
936F	8AJ	92-94	140	12 300 (27,060)	2.3 (3.00)	12 920 (28,483)	2.58 (8'5")	379 (14.9")	997 (3'3")	2.84 (9'4")	42.3 (26.3)	46.7 (29.6)	3304 Engine Box Frame
938F		94-97	140	13 030 (28,730)	2.5 (3.25)	12 330 (27,180)	2.61 (8'7")	400 (16")	1004 (3'4")	2.85 (9'4")	37.9 (23.6)	22.0 (13.7)	3116 Engine Wet Disc Brakes Z Bar Linkage
944	87J	59-68	100	10 100 (22,000)	1.53 (2.0)	9800 (21,700)	2.40 (7'10")	450 (18")	905 (3'0")	2.96 (9'9")	38.5 (23.9)	46.6 (28.9)	

Wheel Loaders (cont'd)

Model	Product Ident. No. Prefix	Years Built	Flywheel Horse-power	Approx. Shipping Wt. kg (lb)	Rated Capacity m ³ (yd ³)	Breakout Force kg (lb)	Width Over Tires m (ft)	Ground Clearance mm (in)	Max. Reach at max height m (ft)	Dump Clearance at max height m (ft)	Maximum Speeds km/h (mph)		Remarks
											Fwd.	Rev.	
950	81J	68-81	130	12 930 (28,500)	1.53 (2.07)	10 320 (22,760)	2.41 (7'11")	381 (15")	740 (2'5")	2.82 (9'3")	35.9 (22.3)	42.5 (26.4)	Articulated Steering, 4 Wheel Drive
950B	22Z	81-87	155	14 650 (32,300)	9.5 (3.75)	15 680 (35,895)	2.67 (5'9")	427 (16.8")	1125 (3'8")	2.95 (9'8")	36.4 (22.6)	39.4 (24.5)	Z Bar Linkage
950E	22Z	87-91	160	15 856 (34,883)	3.1 (4.0)	13 586 (29,925)	2.76 (9'0")	400 (15.7")	1160 (3'10")	2.85 (9'4")	36.2 (22.4)	39.9 (24.7)	
950F	7ZF	90-92	170	16 086 (35,463)	3.1 (4.0)	14 954 (32,974)	2.76 (9'0")	474 (18.7")	1160 (3'10")	2.85 (9'4")	39.3 (24.4)	43.0 (26.7)	3116 Engine Wet Disc Brakes
950F II	5SK	93-98	170	16 880 (37,220)	3.1 (4.0)	14 960 (32,980)	2.76 (9'0")	460 (18.1")	1180 (3'10")	2.83 (9'3")	38.7 (24.0)	42.7 (26.5)	
960F	9ZJ	94-98	200	18 070 (39,840)	3.5 (4.5)	14 500 (31,970)	2.77 (9'1")	454 (17.9")	1030 (3'5")	2.92 (9'6")	39.4 (24.5)	43.2 (26.8)	Material Handler
966A	33A	60-63	140	13 060 (28,800)	2.10 (2.75)	13 470 (29,700)	2.70 (8'10")	450 (18")	900 (3'0")	2.95 (9'8")	43.0 (26.7)	51.5 (32.3)	
966B	75A	63-68	150	14 300 (31,500)	2.29 (3.0)	14 000 (31,000)	2.70 (8'10")	400 (16")	900 (3'0")	2.95 (9'8")	38.5 (23.9)	46.3 (28.8)	
966C	76J	68-81	170	16 730 (36,890)	3.1 (4.0)	11 600 (25,578)	2.77 (9'1")	400 (15.7")	1420 (4'8")	2.95 (9'8")	38.0 (23.6)	45.1 (28.0)	3306 Engine
966D	99Y	80-87	200	19 730 (43,500)	3.3 (4.25)	20 972 (48,150)	2.86 (9'4.8")	451 (17.8")	1230 (4'0")	3.14 (10'3.5")	34.3 (21.3)	38.1 (23.7)	3306 Engine Z Bar Linkage
966E	99Y	87-90	216	20 324 (44,767)	3.8 (5.0)	18 939 (41,715)	2.94 (9'8")	476 (18.7")	1290 (4'3")	2.97 (9'9")	38.2 (23.7)	43.6 (27.0)	
966F	4YG	90-93	220	20 466 (45,119)	3.8 (5.0)	20 493 (45,187)	2.94 (9'8")	476 (18.7")	1280 (4'2")	2.98 (9'9")	37.6 (23.4)	42.6 (26.4)	Wet Disc Brakes
980	42H	66-70	235	20 000 (44,000)	3.06 (4.0)	18 860 (41,570)	2.87 (9'5")	399 (16")	1190 (3'11")	3.07 (10'1")	42.0 (26.1)	26.7 (16.6)	
980B	89P	70-78	260	23 360 (51,500)	3.44-4.21 (4.5-5.5)	15 900 (35,100)	3.11 (10'2")	— (—)	1120 (3'8")	3.20 (10'6")	43.0 (26.7)	27.4 (17.0)	
980C	63X	79-91	270	27 559 (60,755)	5.2 (6.75)	23 188 (51,121)	3.15 (10'4")	417 (16.4")	1480 (4'10")	3.19 (10'6")	34.6 (21.5)	39.6 (24.5)	Dual Z Bar Linkage
980F	8CJ	91-92	275	27 580 (60,800)	5.3 (7.0)	23 188 (51,121)	3.15 (10'4")	469 (18.5")	1500 (4'11")	3.16 (10'5")	37.4 (23.2)	42.8 (26.6)	Electronic Shift
980F-II		92-95											
988	87A	63-76	325	35 800 (79,000)	4.6-5.4 (6.0-7.0)	21 380 (47,130)	3.20 (10'7")	570 (22.5")	1450 (4'9")	3.33 (10'11")	30.6 (19.0)	30.6 (19.0)	
988B	50W	76-93	375	43 365 (95,600)	5.4-6.3 (7.0-8.25)	36 330 (80,100)	3.52 (11'7")	474 (18")	2150 (7'1")	3.19 (10'5")	36.2 (22.5)	41.4 (25.7)	3408 Engine Z Bar Linkage
988F	8YG	93-95	400	43 540 (95,500)	5.4-6.1 (7.0-8.0)	37 363 (82,371)	3.52 (11'7")	496 (19")	1830 (6'0")	3.21 (10'6")	35.1 (21.8)	23.5 (14.6)	Bucket/HP increase STIC Steer
990	7HK	93-95	610	72 910 (160,600)	8.6 (11.2)	59 776 (131,784)	4.13 (13'6")	552 (21.7")	2070 (6'10")	3.99 (13'1")	22.5 (14.0)	25.0 (15.5)	ICTC & New Model
992	25K	68-73	550	47 670 (105,100)	7.65 (10.0)	36 900 (81,360)	3.93 (12'11")	530 (21")	2820 (8'3")	4.52 (14'10")	35.6 (22.1)	38.5 (23.8)	
992B	25K	73-77	550	64 320 (141,800)	7.65 (10.0)	29 330 (64,660)	— (—)	— (—)	1930 (6'4")	4.34 (14'3")	40.2 (25.0)	43.6 (27.1)	
992C	97X	77-81	690	85 640 (188,800)	9.6 (12.5)	66 240 (146,030)	4.55 (14'11")	533 (21")	2310 (7'7")	4.17 (13'8")	21.1 (13.1)	23.3 (14.5)	3412 PCT Engine Z Bar Linkage
992C	49Z	81-92	690	88 430 (194,950)	10.4 (13.5)	66 285 (146,132)	4.50 (14'9")	544 (21")	2310 (7'7")	4.17 (13'8")	21.0 (13.0)	22.9 (14.2)	3412 DIT Engine
992D	7MJ	92-97	710	88 690 (195,125)	10.7 (14.0)	62 670 (137,870)	4.50 (14'9")	544 (21")	2300 (7'7")	4.17 (13'8")	21.0 (13.0)	22.9 (14.2)	



TRACK LOADERS

Model	Product Ident. No. Prefix	Years Built	Flywheel Horsepower	Approx. Operating Weight kg (lb)	Rated Capacity m ³ (yd ³)	Dimensions			Remarks
						Length** m (ft)	Width m (ft)	Height m (ft)	
931	78U	72-79	62	6940 (15,300)	0.77 (1.0)	2.74 (9'0")	1.78 (5'10")	1.96 (6'5")	
931 LGP	10N	75-79	62	7498 (16,530)	1.15 (1.5)	2.74 (9'0")	2.29 (7'6")	1.98 (6'6")	
931B	29Y	79-88	65	7362 (16,230)	0.8 (1.0)	4.13 (13'9")	1.84 (6'0.5")	2.68 (8'10")	
931B LGP	30Y	79-88	65	8089 (17,834)	0.8 (1.0)	3.84 (12'7")	2.41 (7'11")	2.68 (8'10")	
931C	2BJ1 7HF		67	7595 (16,743)	0.77 (1.0)	2.74 (9'0")	1.78 (5'10")	2.68 (8'10")	
931C LGP	6RF1 8AF		67	8170 (18,012)	0.77 (1.0)	2.74 (9'0")	1.78 (5'10")	2.68 (8'10")	
931C Series II	9AG 6AJ	90-93	70	8047 (17,742)	0.83 (1.08)	4.14 (13'1")	1.97 (6'5")	2.68 (8'10")	
933C	11A	55-58	50	7030 (15,500)	0.77 (1.0)	4.22 (13'10")	1.77 (5'10")	1.91 (6'4")	Integral loader.
933E	11A	58-65	50	7640 (16,850)	0.77 (1.0)	4.22 (13'10")	1.77 (5'10")	1.40 (6'3")	Integral loader.
933G	42A	65-68	60	7900 (17,500)	0.86 (1.125)	4.31 (14'2")	1.77 (5'10")	2.15 (7'1")	Patented Sealed Track.
935B	30F	87-88	75	7899 (17,414)	1.0 (1.25)	4.19 (13'9")	1.96 (6'5")	2.68 (8'10")	
935C	8CF		78	8205 (18,089)	1.0 (1.3)	4.19 (13'9")	1.96 (6'5")	2.68 (8'10")	
935C Series II	SDJ	90-93	80	8759 (19,311)	1.0 (1.3)	4.37 (14'4")	1.97 (6'5")	2.68 (8'10")	
941	80H	68-72	70	8900 (19,700)	0.96 (1.25)	4.50 (14'10")	1.86 (6'1")	2.75 (9'0")*	Electric Start.
941B	80H	68-81	80	11 294 (24,900)	1.15 (1.5)	4.50 (14'10")	1.98 (6'6")	2.75 (9'0")*	HP Increase, Hydraulic Track Adjusters.
943	31Y	80-85	80	11 750 (25,900)	1.15 (1.5)	5.426 (17'10")	2.21 (8'7")	3.02 (9'11")	Hydrostatic drive.
943	19Z	80-92	80	11 750 (25,900)	1.15 (1.5)	5.426 (17'10")	2.21 (8'7")	3.02 (9'11")	Hydrostatic drive made in France.
951B	79H	67-71	85	10 025 (22,100)	1.14 (1.5)	4.70 (15'6")	1.98 (6'6")	2.75 (9'0")*	Pedal Steering.
951C	86J	71-81	95	12 338 (27,200)	1.34 (1.75)	4.77 (15'8")	1.98 (6'6")	2.75 (9'0")*	HP Increase, Sealed & Lubricated Track.

*Height to top of stack. Others to top of seat back.

**Overall length to tip of smallest General Purpose bucket.

Track Loaders (cont'd)

Model	Product Ident. No. Prefix	Years Built	Flywheel Horsepower	Approx. Operating Weight kg (lb)	Rated Capacity m ³ (yd ³)	Dimensions			Remarks
						Length** m (ft)	Width m (ft)	Height m (ft)	
953	5Z	81-85	110	14 050 (31,000)	1.5 (2.0)	5.87 (19'3")	2.38 (7'10")	3.08 (10'1")	Hydrostatic drive.
953	20Z	81-92	110	14 050 (31,000)	1.5 (2.0)	5.87 (19'3")	2.38 (7'10")	3.08 (10'1")	Hydrostatic drive.
953	76Y	81-85	110	13 800 (30,500)	1.5 (2.0)	5.87 (19'3")	2.38 (7'10")	3.08 (10'1")	Hydrostatic drive.
953	77Y	81-85	110	13 800 (30,500)	1.5 (2.0)	5.87 (19'3")	2.38 (7'10")	3.08 (10'1")	Hydrostatic drive.
953B	5MK	92-96	120	14 400 (31,800)	1.75 (2.25)	4.23 (13'4")	2.38 (7'10")	3.08 (10'1")	Hydrostatic drive.
HT4	7U	50-55	54	2607 (5748)	0.96 (1.25)	4.32 (14'2")	2.03 (6'8")	1.83 (6'0")	Integral loader.
955C	12A	55-60	70	9590 (21,145)	1.15 (1.5)	4.60 (15'2")	2.03 (6'8")	2.08 (6'11")	
955E	12A	58-60	70	10 160 (22,400)	1.15 (1.5)	4.60 (15'2")	2.03 (6'8")	2.08 (6'11")	Improved undercarriage.
955H	60A	60-66	100	11 320 (24,950)	1.34 (1.75)	4.79 (15'9")	1.90 (6'3")	2.65 (8'8")*	Power shift, Turbo, oil cooled brakes.
955K	61H	66-71	115	12 700 (28,000)	1.34 (1.75)	5.00 (16'6")	2.06 (6'9")	2.80 (9'3")*	Horsepower and bucket capacity increase.
955L	85J	71-75	130	15 330 (33,800)	1.53 (2.0)	5.30 (16'1")	2.18 (7'2")	2.95 (9'8")*	ROPS Cab, Sealed & Lubricated Track.
955L	13X	75-81	130	15 853 (34,950)	1.72 (2.25)	5.26 (17'3")	2.18 (7'2")	2.95 (9'8")	
963	6Z	81-85	150	18 250 (40,250)	2.0 (2.6)	6.35 (20'10")	2.50 (8'2")	3.30 (10'10")	Hydrostatic drive.
963	11Z	81-85	150	18 370 (40,490)	2.0 (2.6)	6.35 (20'10")	2.50 (8'2")	3.30 (10'10")	Hydrostatic drive.
963	18Z	82-86	150	18 250 (40,250)	2.0 (2.6)	6.35 (20'10")	2.50 (8'2")	3.30 (10'10")	Hydrostatic drive made in France.
963	21Z	82-95	150	18 370 (40,490)	2.0 (2.6)	6.35 (20'10")	2.50 (8'2")	3.30 (10'10")	Hydrostatic drive made in France.
No. 6	10A	53-55	80	13 229 (29,165)	1.5 (2.0)	4.90 (16'1")	2.44 (8'1")	2.11 (6'11")	Improved undercarriage.
977D	20A	55-60	100	14 430 (31,795)	1.72 (2.25)	5.19 (18'0")	2.44 (8'0")	2.22 (7'4")	
977E	20A	58-60	100	15 850 (34,910)	1.72 (2.25)	5.19 (18'0")	2.44 (8'0")	2.29 (7'7")	Power shift, Turbo, oil cooled brakes.
977H	53A	60-66	150	17 000 (37,500)	1.90 (2.5)	5.28 (17'4")	2.44 (8'0")	2.29 (7'7")	Walk-through compartment, longer roller frame.
977K	46H	66-78	170	19 100 (42,000)	1.90 (2.5)	5.50 (18'0")	2.38 (7'10")	3.05 (10'0")*	Horsepower and bucket capacity increase.
977L	14X	78-82	190	21 780 (48,010)	2.10 (2.75)	5.59 (18'4")	2.38 (7'10")	3.32 (10'11")*	
983	38K	69-78	275	34 460 (75,980)	3.82 (5.0)	6.78 (22'3")	2.90 (9'6")	2.79 (11'10")*	
983B	58X	78-82	275	35 620 (78,530)	3.82 (5.0)	6.78 (22'3")	2.90 (9'6")	3.68 (12'1")*	DI engine.

*Height to top of stack. Others to top of seat back.

**Overall length to tip of smallest General Purpose bucket.



INTEGRATED TOOLCARRIERS

Model	Product Ident. No. Prefix	Years Built	Flywheel Horsepower	Approx. Operating Weight kg (lb)	Rated Capacity m ³ (yd ³)	Breakout Force kg (lb)	Width Over Tires m (ft)	Ground Clearance mm (in)	Max Reach at Max Height mm (in)	Dump Clearance at Max Height m (ft)	Maximum Speeds	
											km/h Fwd.	(mph) Rev.
IT12	2YC	84-89	65	7393 (16,299)	1.0 (1.25)	7193 (15,858)	2.3 (7'8")	405 (15.9")	873 (34")	2.84 (9'4")	23.6 (14.6)	24.9 (15.4)
IT12B	1KF	89-93	78	7950 (17,530)	1.2 (1.6)	6160 (13,583)	2.15 (7'1")	343 (13.5")	958 (37.7")	2.69 (8'10")	34 (21.1)	22.4 (13.9)
IT12F	1KF	93-95	80	7893 (17,401)	1.3 (1.7)	6479 (14,247)	2.15 (7'1")	365 (1'2")	917 (3'1")	2.74 (8'11.8")	34 (21.1)	22.4 (13.9)
IT14B	3NJ	89-93	85	8333 (18,374)	1.2 (1.6)	7525 (16,593)	2.15 (7'1")	344 (13.6")	958 (37.7")	2.70 (8'11")	37.3 (23.2)	24.4 (15.2)
IT14F	4EL	93-95	85	7999 (17,635)	1.3 (1.7)	7170 (15,808)	2.15 (7'1")	365 (1'2")	918 (3'1")	2.74 (9'0")	37.3 (23.2)	24.4 (15.2)
IT18	9NB	84-86	85	8660 (19,092)	1.2 (1.5)	9105 (20,108)	2.4 (7'10")	285 (11.2")	990 (39")	2.84 (9'4")	25 (15.5)	25 (15.5)
IT18B	4ZD	86-92	95	9770 (21,540)	1.3 (1.75)	10 500 (21,350)	2.28 (7'6")	324 (12.8")	993 (39")	2.89 (9'6")	26.4 (16.4)	27.7 (17.2)
IT18F	6ZF	92-94	105	9959 (21,960)	1.6 (2.0)	8880 (19,580)	2.33 (7'8")	321 (1'1")	1089 (3'7")	2.75 (9'0")	37 (23)	24.5 (15.2)
IT28	2KC	84-86	105	9560 (21,076)	1.5 (2.0)	9505 (20,955)	2.4 (7'10")	285 (11.2")	1044 (41")	2.82 (9'3")	30.8 (18.8)	32.3 (20.0)
IT28B	1HF	86-93	110	10 580 (23,325)	1.7 (2.25)	10 456 (23,050)	2.32 (7'7")	324 (12.8")	1091 (43")	2.73 (8'11")	34.4 (21.4)	37.2 (23.1)
IT28F	3CL	93-96	125	11 430 (25,200)	2.0 (2.6)	9840 (21,700)	2.43 (8'0")	317 (12")	1093 (43")	2.72 (8'11")	35.4 (21.9)	21.4 (13.5)
950F CT	5SK	94-98	170	16 600 (36,580)	3.1 (4.0)	13 590 (29,950)	2.87 (9'5")	460 (18")	1714 (68")	2.845 (9'4")	38.7 (24.0)	42.7 (26.5)



PAVING PRODUCTS — COLD PLANERS

Model	Product Ident. No. Prefix	Years Built	kW Flywheel (Horsepower)	Approximate Operating Weight kg (lb)	General Dimensions (Shipping)		
					Height mm (ft)	Length mm (ft)	Width mm (ft)
PR-75	6RC	85-92	52 (77)	5900 (13,000)	2690 (8'10")	3050 (10'0")	2130 (7'0")
PR-105		85-92	67 (90)	7711 (17,000)	2921 (9'7")	3581 (11'9")	2515 (8'3")
PR-275		—	201 (270)	17 237 (38,000)	2896 (9'6")	5740 (18'10")	2438 (8'0")
PR-450		85-92	336 (450)	28 308 (58,000)	4270 (14'0")	13 280 (43'8")	2870 (9'5")
PR-450C		92-97	336 (450)	28 308 (58,000)	3810 (12'6")	13 200 (43'6")	2490 (8'2")
PR-750B		85-92	559 (750)	42 638 (94,000)	3734 (12'3")	16 500 (54'0")	3575 (11'9")
PR-1000		Cutter	559 (750)	46 780 (103,130)	3810 (12'6")	16 590 (54'5")	4877 (16'0")
		Track	186 (250)				



PAVING PRODUCTS — RECLAIMERS & STABILIZERS

Model	Product Ident. No. Prefix	Years Built	kW Flywheel (Horsepower)	Approximate Operating Weight kg (lb)	General Dimensions (Shipping)		
					Height mm (ft)	Length mm (ft)	Width mm (ft)
SS-250	6DD	85-96	250 (335)	13 300 (29,300)	3220 (10'7")	8780 (28'10")	2900 (9'7")
RR-250	6ED	85-96	250 (335)	17 876 (39,300)	3220 (10'7")	8780 (28'10")	2900 (9'7")



PAVING PRODUCTS — UNITIZED VENTURI-MIXERS & UNITIZED DRUM-MIXERS

Drum Dimensions			Performance		
Model	Diameter mm (ft)	Length m (ft)	Gross Volume m ³ (ft ³)	Production Range/hr. metric tons (tons)	Air Flow m ³ /min (ft ³ /min)
UVM-500	1829/1524 (6'0"/5'0")	7.9 (26'0")	14.17 (500)	68-109 (75-120)	300-481 (10,600-17,000)
UDM-600	1829 (6'0")	6.7 (22'0")	17.00 (600)	82 (89)	354.25 (12,500)
UDM-900	2134/1829 (7'0"/6'0")	9.1 (30'0")	25.48 (900)	68-227 (75-250)	311-793 (11,000-28,000)
UVM-1000	2134 (7'0")	9.754 (32'0")	28.34 (1000)	82-272 (90-300)	425-1076 (15,000-38,000)
UVM-1400	2286 (7'6")	10.973 (36'0")	39.64 (1400)	100-358 (110-395)	481-1274 (17,000-45,000)
UVM-1700	2591 (8'6")	11.582 (38'0")	48.14 (1700)	122-480 (135-450)	651-1614 (23,000-57,000)



PAVING PRODUCTS — PORTABLE VENTURI-MIXERS

Drum Dimensions			Performance		
Model	Diameter mm (ft)	Length m (ft)	Gross Volume m ³ (ft ³)	Production Range/hr. metric tons (tons)	Air Flow m ³ /min (ft ³ /min)
PVM-1100	2134 (7'0")	10.97 (36'0")	31.15 (1100)	82-295 (90-325)	425-1133 (15,000-40,000)
PVM-1500	2286 (7'6")	12.19 (40'0")	42.48 (1500)	100-363 (110-400)	510-1274 (18,000-45,000)
PVM-2000	2591 (8'6")	12.80 (42'0")	56.64 (2000)	122-454 (135-500)	680-1699 (24,000-60,000)
PVM-2500	2896 (9'6")	12.80 (42'0")	70.79 (2500)	136-499 (150-550)	793-2110 (28,000-74,500)
PVM-2900	3048 (10'0")	13.41 (44'0")	82.12 (2900)	168-553 (185-610)	906-2265 (32,000-80,000)
PVM-3300	3200 (10'6")	13.41 (44'0")	93.45 (3300)	181-612 (200-675)	991-2464 (35,000-87,000)

- Paving Products
- Stationary Venturi-Mixers
- SlipForm Pavers

Former Models



PAVING PRODUCTS — STATIONARY VENTURI-MIXERS

Model	Drum Dimensions			Performance	
	Diameter mm (ft)	Length m (ft)	Gross Volume m ³ (ft ³)	Production Range/hr. metric tons (tons)	Air Flow m ³ /min (ft ³ /min)
SVM-1100	2134 (7'0")	10.97 (36'0")	31.15 (1100)	82-295 (90-325)	425-1133 (15,000-40,000)
SVM-1500	2286 (7'6")	12.19 (40'0")	42.48 (1500)	100-363 (110-400)	510-1274 (18,000-45,000)
SVM-2000	2591 (8'6")	12.80 (42'0")	56.64 (2000)	122-454 (135-500)	680-1699 (24,000-60,000)
SVM-2500	2896 (9'6")	12.80 (42'0")	70.79 (2500)	136-499 (150-550)	793-2110 (28,000-74,500)
SVM-2900	3048 (10'0")	13.41 (44'0")	82.12 (2900)	168-553 (185-610)	906-2265 (32,000-80,000)
SVM-3600	3200 (10'6")	14.63 (48'0")	101.94 (3600)	190-623 (210-685)	1020-2565 (36,000-90,000)



PAVING PRODUCTS — SLIPFORM PAVERS

Model	Product Ident. No. Prefix	Years Built	Flywheel Horsepower	Approx. Operating Weight kg (lb)	Standard Paving Width m (ft)	Shipping Dimensions (Min.)			Remarks
						Length m (ft)	Width m (ft)	Height m (ft)	
SF-175	5ZC	—	142	9072 (20,000)	2.1 (7'0")	6.6 (21'6")	2.4 (8'0")	2.8 (9'4")	
SF-250	6XC	—	208	24 494 (54,000)	3.6 (12'0")	3.0 (10'0")	3.7 (12'0")		
SF-250B	—	—	250	27 216 (60,000)	3.7-7.3 (12'0"-24'0")	1.5 (5'0")	3.66 (12'0")	3.20 (10'6")	
SF-350	—	—	290	40 824 (90,000)	3.6-7.3 (12'0"-24'0")	1.04 (3'5")	3.0 (10'0")	2.9 (9'8")	
SF-450	7GC	73-83	400	43 546* (96,000) 53 525** (118,000)	3.66-7.62 (12'0"-25'0")	9.35 (30'8")	3.05 (10'0")	2.90 (9'6")	
SF-500	8DC	—	400	52 164 (115,000)	7.6 (25'0")	8.9 (29'2½")	3.0 (10'0")	3.0*** (10'2")	
SF-550	5PD	—	400	52 164 (115,000)	5.5-8.5 (18'0"-28'0")	7 (23'0")	3.7 (12'0")	2.9 (9'8")	

*Weight of 25'0" machine.

**Weight of 38'0" machine.

***Machine legs and track shipped separately.

Former Models

Paving Products

- Placer-Spreader-Trimmer ● Texturing/Curing
- Belt Placer ● Trimmer Reclaimer
- Tube Finisher



PAVING PRODUCTS — PLACER-SPREADER-TRIMMER, BELT PLACER

Model	Product Ident. No. Prefix	Years Built	Flywheel Horsepower	Approximate Operating Weight kg (lb)	General Dimensions		
					Height m (ft)	Length m (ft)	Width m (ft)
PST-300	8EC	—	250	38 193 (84,200)	2.64 (8'8")	10.57 (34'8")	9.02 (29'7")
BP-100	1EF	—	102	11 340 (22,000)	3.27 (10'9")	2.49 (8'2")	2.49 (8'2")



PAVING PRODUCTS — TUBE FINISHER, TEXTURING/CURING

Model	Product Ident. No. Prefix	Years Built	Flywheel Horsepower	Approximate Operating Weight kg (lb)	General Dimensions (Shipping)		
					Height mm (ft)	Length mm (ft)	Width mm (ft)
TF-250	6YC	—	52	5897 (13,000)	2489 (8'2")	8484 (27'10")	2438 (8'0")
TC-250	7HC	—	56	5897 (13,000)	2489 (8'2")	8484 (27'10")	2438 (8'0")

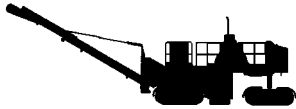

PAVING PRODUCTS — TRIMMER-RECLAIMER

Model	Product Ident. No. Prefix	Years Built	Flywheel Horsepower	Approximate Operating Weight kg (lb)	General Dimensions (Shipping)		
					Height mm (ft)	Length m (ft)	Width mm (ft)
TR-225B	6WC	—	250	21 319 (47,000)	3200 (10'6")	13.9 (45'9.5")	2896 (9'6")
TR-500	8CC	—	375	46 267 (102,000)	3099 (10'2")	8.9 (29'2¾")	3048 (10'0")



PAVING PRODUCTS — ASPHALT PAVERS & WINDROW ELEVATORS

Model	Product Ident. No. Prefix	Years Built	Flywheel kW (hp)	Approx. Op. Weight kg (lb)	Drive	Screed Width mm (ft)	Hopper Capacity m³ (ft³)	Maximum Op. Speed m/min (ft/min)
AP-800	1BF	86-89	76 (102)	11 903 (26,350)	Wheel	2438 (8'0")	5.8 (206)	95 (312)
AB-800B	1BF	89-93	76 (102)	11 903 (26,350)	Wheel	2438 (8'0")	5.8 (206)	95 (312)
AP-1050	1JG	89-96	116 (155)	14 878 (32,800)	Track	3048 (10'0")	6.2 (215)	57 (186)
AP-1200	2JD	85-89	108 (145)	13 608 (30,000)	Wheel	3048 (10'0")	6.2 (220)	21.4 (13.3)
WE601B	TEC	85-91	78 (102)	3856 (8500)	NA	1524 (5'0")	NA	NA
AP-200	6AD	85-91	26 (35)	4080 (9000)	Track	2743 (9'0")	5.4 (6)	0-54 (0-776)
BG-200A	NA	89-91	35 (47)	6750 (14,900)	Wheel	1803 (5'11")	3.26 (116)	56 (180)
BG-210	NA	90-91	79 (106)	10 192 (22,500)	Wheel	2438 (8'0")	4.76 (170)	84 (275)
BG-220	NA	84-87	58 (78)	9752 (21,500)	Wheel	2438 (8'0")	3.7 (130)	88 (289)
BG-220B	4ZM	91-94	80 (108)	12 483 (27,525)	Wheel	2438 (8'0")	4.3 (155)	88 (289)
BG-225	NA	84-87	58 (78)	11 339 (25,000)	Track	2438 (8'0")	3.7 (130)	58 (188)
BG-225B	NA		118 (158)	16 400 (36,200)	Track	2438 (8'0")	4.3 (155)	57 (189)
BG-240	NA	85-86	72 (96)	13 154 (29,000)	Wheel	3048 (10'0")	3.7 (130)	81 (265)
BG-245	NA	85-87	72 (96)	14 514 (32,000)	Track	3048 (10'0")	5.8 (206)	58 (189)
BG-245B	3XL	87-96	116 (155)	16 080 (35,450)	Track	3048 (10'0")	5.8 (206)	55 (182)
BG-260	NA	85-87	106 (142)	14 514 (32,000)	Wheel	3048 (10'0")	5.8 (206)	77 (253)
BG-260B	NA		116 (155)	14 740 (32,500)	Wheel	3048 (10'0")	5.8 (206)	90 (296)
BG-265	NA	85-87	106 (142)	16 782 (37,000)	Track	3048 (10'0")	5.8 (206)	50 (164)
BG-270B	NA		145 (195)	15 510 (34,200)	Wheel	3048 (10'0")	6.5 (230)	90 (296)
BG-610	NA	85	58 (78)	4394 (9700)	NA	1524 (5'0")	NA	NA
BG-610A	NA	86-90	58 (78)	4911 (10,840)	NA	1524 (5'0")	NA	NA
BG-710	NA		111 (149)	13 380 (29,500)	NA	3048 (10'0")	10.0 (80)	98 (320)
BG-750	NA	87-97	116 (155)	17 010 (37,500)	Wheel	4270 (14'0")	10.0 (80)	0-24.1 (0-15.0)
MTP-1260	NA	86-90	58 (78)	4911 (10,840)	NA	3048 (10'0")	7.7 (275)	58 (189)
MTP-1265	NA	88-91	167 (224)	25 368 (56,000)	NA	3048 (10'0")	11.2 (400)	50 (164)



PAVING PRODUCTS — SOIL VIBRATORY COMPACTORS

Model	Product Ident. No. Prefix	Years Built	Flywheel kW (hp)	Approx. Op. Weight kg (lb)	Drive	Drum Width mm (in)	Dynamic Force kg (lb)	Maximum Op. Speed km/h (mph)
CS-323	1TM	85-95	57 (77)	4173 (9200)	Wheel/ Drum	1219 (48")	5760 (12,700)	0-10.9 (0-6.8)
CP-323	6JD	85-95	57 (77)	4218 (9300)	Wheel/ Drum	1219 (48")	5760 (12,700)	0-10.9 (0-6.8)
CS-431	6MD	85-87	52 (70)	6110 (13,480)	Wheel	1680 (66")	7260 (16,000)	21 (13)
CS-431B	1XF	88-94	76.5 (102)	6312 (13,915)	Wheel	1680 (66")	11 235 (24,746)	12.8 (8.0)
CS-433	6ND	85-87	60 (80)	6720 (14,820)	Wheel/ Drum	1524 (60")	7260 (16,000)	10 (6)
CP-433	6NP	85-87	60 (80)	6750 (14,870)	Wheel/ Drum	1524 (60")	7260 (16,000)	10 (6)
CS-433B	4FK	88-94	76.5 (102)	6448 (14,215)	Wheel/ Drum	1680 (66")	11 235 (24,746)	12.8 (8.0)
CP-433B	1MG	88-94	76.5 (102)	6668 (15,225)	Wheel/ Drum	1680 (66")	11 235 (24,746)	12.8 (8.0)
CS-531	3WM	93-95	108 (145)	9310 (20,500)	Wheel	2134 (84")	22 680 (50,000)	12.8 (8.0)
CS-533	3BL	93-95	108 (145)	10 110 (22,500)	Wheel/ Drum	2134 (84")	22 680 (50,000)	12.8 (8.0)
CP-533	3ZL	93-95	108 (145)	11 470 (25,250)	Wheel/ Drum	2134 (84")	22 680 (50,000)	12.8 (8.0)
CS-551	6ZD 8AD	85-89	115 (155)	10 428 (22,990)	Wheel	2130 (84")	18 150 (40,000)	12.1 (7.5)
CS-553	7AD	85-89	115 (155)	10 782 (23,770)	Wheel/ Drum	2130 (84")	18 150 (40,000)	10.5 (6.5)
CP-553	7BD	85-89	115 (155)	12 247 (27,000)	Wheel/ Drum	2130 (84")	22 680 (50,000)	10.5 (6.5)
CS-563	8XF	89-95	108 (145)	11 130 (24,500)	Wheel/ Drum	2134 (84")	22 680 (50,000)	12.8 (8.0)
CP-563	1YJ	89-95	108 (145)	11 580 (25,800)	Wheel/ Drum	2134 (84")	22 680 (50,000)	12.8 (8.0)
CS-583	8YJ	91-95	108 (145)	15 040 (33,090)	Wheel/ Drum	2134 (84")	22 680 (50,000)	12.8 (8.0)
CS-643	7FD	85-87	100 (134)	14 900 (32,855)	Wheel/ Drum	2200 (86")	16 800 (37,044)	15.5 (9.6)
CP-643	7GD	85-87	100 (134)	16 300 (35,942)	Wheel/ Drum	2200 (86")	12 600 (27,783)	15.5 (9.6)
CS-653	7HD	85-91	100 (134)	17 100 (37,690)	Wheel/ Drum	2200 (86")	22 230 (48,995)	15.5 (9.6)
CP-653	7JD	85-91	100 (134)	18 500 (40,774)	Wheel/ Drum	2200 (86")	22 230 (48,995)	15.5 (9.6)
TSF-54	7KD	85-88	26 (35)	2131 (4700)	Towed	1370 (54")	6810 (15,000)	Towed
TSM-54	7LD	86-88	26 (35)	2160 (4760)	Towed	1370 (54")	6810 (15,000)	Towed



PAVING PRODUCTS — ASPHALT VIBRATORY COMPACTORS

Model	Product Ident. No. Prefix	Years Built	Flywheel kW (hp)	Approx. Op. Weight kg (lb)	Drive	Drum Width mm (in)	Dynamic Force kg (lb)	Maximum Op. Speed km/h (mph)
CB-214	6FD	85-88	24 (33)	2300 (5070)	Drum (2)	1000 (39.4")	2041 (4500)	10.6 (6.6)
CB-214B	6LF	88-93	24 (33)	2300 (5072)	Drum (2)	990 (39")	2018 (4450)	10.4 (6.5)
CB-224	6GD	85-88	24 (33)	2450 (5400)	Drum (2)	1200 (47.2")	2450 (5400)	10.6 (6.6)
CB-224B	6LF	88-93	24 (33)	2450 (5402)	Drum (2)	1199 (47.2")	2449 (5400)	10.4 (6.5)
CB-314	6HD	85-89	41 (55)	3357 (7400)	Drum	1120 (44")	2770 (6100)	8 (5)
CB-414	6KD	85-89	52 (70)	5780 (12,750)	Drum	1397 (55")	6350 (14,000)	13.7 (8.5)
CB-424	6LD	85-89	54 (73.5)	6220 (13,710)	Drum (2)	1397 (55")	4485 (9885)	11.0 (6.8)
CB-434	3TF	89-94	60 (80)	6610 (14,540)	Drum (2)	1422 (56")	7620 (16,800)	11.6 (7.2)
CB-434B*	6AL	94-95	60 (80)	6577 (14,500)	Drums	1422 (56")	7620 (16,800)	0-11.6 (0-7.2)
CB-514	6YD	85-88	68 (91)	9730 (21,450)	Drum (2)	1730 (68")	9073 (20,000)	11 (7)
CB-614	7CD	85-93	115 (155)	11 340 (25,000)	Drum (2)	1980 (78")	9525 (21,000)	11.2 (7)
CB-521	6RD	85-87	61 (82)	8800 (19,404)	Wheel	1700 (67")	5300 (11,687)	15 (9.3)
CB-522	6SD	85-87	45 (62)	10 100 (22,271)	Drum (2)	1700 (67")	10 350 (22,822)	8 (5)
CB-523	6TD	85-87	61 (82)	8800 (19,404)	Wheel/ Drum	1700 (67")	5300 (11,687)	13 (8)
CB-524	6WD	85-87	61 (82)	9500 (20,948)	Drum (2)	1700 (67")	10 350 (22,822)	11 (6.8)
CB-534	6EG2YF	87-93	93 (125)	9117 (20,100)	Drum (2)	1700 (67")	11 800 (26,019)	11.2 (7)
CB-534B*	4JL	93-95	80 (107)	9117 (20,100)	Drums	1676 (66")	12 043 (26,550)	0-11.3 (0-7.0)
CB-634	5CL	94-95	108 (145)		Drums	2134 (84")	12 043 (26,550)	0-9.2 (0-5.7)
PF-200		85-92	49 (66)	7000 (15,430)	Wheel Pneumatic	1700 (67")	NA	24 (14.9)
PS-110	7MD	85-96	57 (77)	12 500 (27,550)	Wheel Pneumatic	2134 (84")	NA	38.6 (24)
PS-130	7ND	85-96	57 (77)	12 500 (27,550)	Wheel Pneumatic	1700 (68")	NA	38.6 (24)
PS-150	7PD	85-96	57 (77)	15 050 (37,300)	Mechanical	1700 (68")	NA	38.6 (24)
PS-300		85-95	77	21 000	Mechanical	1900	NA	26.5
PF-300		85-95	(102)	(46,200)		(75")		(16.4)

*Non-current for U.S. only.



UNDERGROUND MINING

LHD Model	Product Ident. No. Prefix (USA)	Years Built	Flywheel Horsepower kW (hp)	Approx. Operating Weight kg (lb)	Max Capacity kg (lb)	Length m (ft)	Height m (ft)	Bucket Width mm (ft)	Breakout Force kg (lb)	Maximum Speeds km/h (mph)	
										Forward	Reverse
R1500	NA	NA	178 (239)	25 100 (55,360)	9000 (19,850)	9.19 (30'2")	2.30 (7'7")	2480 (8'2")	18 460 (140,700)	30.4 (18.9)	33.0 (20.5)
R2800	NA	NA	231 (310)	42 660 (94,070)	16 200 (35,720)	10.70 (35'1")	2.68 (8'10")	3000 (9'10")	26 540 (68,530)	29.3 (18.2)	33.3 (20.7)

ESTIMATING OWNING & OPERATING COSTS

CONTENTS

Estimating form 21-2
Explanation of form:
 Estimating Owning Costs 21-5
 Guide for selecting ownership period . . . 21-6
 Agricultural tractors depreciation 21-9
 ① Delivered price 21-9
 ② Residual value at replacement 21-9
 ③ Value to be recovered through work . . . 21-10
 ④ Interest 21-10
 ⑤ Insurance 21-10
 ⑥ Taxes 21-10
 ⑧ Fuel consumption 21-11
 ⑨ Lube oils, filters, grease tables 21-20
 ⑩ Tires:
 Tire life estimator curves 21-27
 Goodyear life estimating system 21-30
 ⑩ Undercarriage 21-31
 Basic factors and conditions
 multipliers 21-32
 ⑪ Repair reserve 21-33
 Cost estimating bar graphs 21-35
 ⑫ Special wear items 21-42
 ⑮ Operator's hourly wage 21-42
O & O Cost Examples
 Example I: Track-Type Tractor 21-42
 Example II: Wheel Loader 21-44
 O & O form with example figures 21-45
Quick estimators 21-48

General

Machine users must balance Productivity and Costs to achieve optimum performance ... that is, achieve the desired production at the lowest possible cost. The approach most often used to measure machine performance is this simple equation:

$$\frac{\text{Lowest Possible Hourly Costs}}{\text{Highest Possible Hourly Productivity}} = \frac{\text{Top Machine Performance}}$$

Most sections of this Handbook deal with the productivity of Caterpillar machines. This section considers the cost aspect of performance.

Hourly Owning and Operating Costs for a given machine can vary widely because they are influenced by many factors: the type of work the machine does, local prices of fuel and lubricants, shipping costs from the factory, interest rates, etc. No attempt is made in this handbook to provide precise hourly costs for each model. Users must be able to estimate with a reasonable degree of accuracy what a machine will cost per hour to own and operate in a given application and locality. Therefore, this section provides a suggested method of estimating hourly owning and operating costs as well as data on Caterpillar-built machines which, when coupled with local conditions, will permit accurate estimates.

The method suggested follows several basic principles:

- No prices are provided for any items. For reliable estimates, these must always be obtained locally.
- Calculations are based on the complete machine. Separate estimates are not necessary for the basic machine, dozer, control, etc.
- The multiplier factors provided will work equally well in any currency expressed in decimals.
- Because of different standards of comparison, what may seem a severe application to one machine owner may appear only average to another. Therefore, to better describe machine use, operating conditions and applications are defined in zones.
- Unless otherwise specified, the word "hour" when used in this section means clock or operating hours, not Service Meter Units.

HOURLY OWNING AND OPERATING COST ESTIMATE

DATE _____

(1) (2)

Machine Designation _____
 Estimated Ownership Period (Years) _____
 Estimated Usage (Hours/Year) _____
 Ownership Usage (Total Hours) _____

OWNING COSTS

1. a. Delivered Price (including attachments) _____
 b. Less Tire Replacement Cost if desired _____
 c. Delivered Price Less Tires _____

2. Less Residual Value at Replacement (____%) _____ (____%) _____
 (See subsection 2A on back)

3. a. Value to be recovered through work _____
 (line 1c less line 2)

b. Cost Per Hour:

Value (1) _____ (2) _____
 Hours

4. Interest Costs $\frac{N + 1}{2N} \times \text{Del. Price} \times \frac{\text{Simple Int.}}{\% \text{ Rate}}$ =
 N = No. Yrs. Hours/Year

(1) $\frac{+ 1}{\quad} \times \quad \times \quad \%$ (2) $\frac{+ 1}{\quad} \times \quad \times \quad \%$

_____ = _____ = _____

_____ Hours/Yr. _____ Hours/Yr.

5. Insurance $\frac{N + 1}{2N} \times \text{Del. Price} \times \frac{\text{Insurance}}{\% \text{ Rate}}$ =
 N = No. Yrs. Hours/Year

(1) $\frac{+ 1}{\quad} \times \quad \times \quad \%$ (2) $\frac{+ 1}{\quad} \times \quad \times \quad \%$

_____ = _____ = _____

_____ Hours/Yr. _____ Hours/Yr.

Or

\$ _____ Per Yr. ÷ _____ Hours/Yr. =

	(1)	(2)
6. Property Tax		
N = No. Yrs. $\frac{N + 1}{2N} \times \text{Del. Price} \times \text{Tax Rate \%}$		
Hours/Year		
=		
(1) <u> + 1 </u> × <u> </u> × <u> % </u>		
(2) <u> + 1 </u> × <u> </u> × <u> % </u>		
=		
=		
Hours/Yr.	Hours/Yr.	

Or

\$ Per Yr. ÷ Hours/Yr. =

7. TOTAL HOURLY OWNING COST (add lines 3b, 4, 5, and 6)		
--	--	--

OPERATING COSTS

8. Fuel: Unit Price × Consumption		
(1) <u> </u> × <u> </u> =		
(2) <u> </u> × <u> </u> =		

9. Lube Oils, Filters, Grease: (See subsection 9A on back)		
---	--	--

10. a. Tires: Replacement Cost ÷ Life in Hours		
<u> Cost </u> (1) <u> </u> (2) <u> </u>		
<u> Life </u>		

b. Undercarriage (Impact + Abrasiveness + Z Factor) × Basic Factor		
(1) (<u> </u> + <u> </u> + <u> </u>) = <u> </u> × <u> </u> =		
(2) (<u> </u> + <u> </u> + <u> </u>) = <u> </u> × <u> </u> =		
(Total) (Factor)		

11. Repair Reserve (Extended Use Multiplier × Basic Repair Factor)		
(1) <u> </u> × <u> </u> = (2) <u> </u> × <u> </u> =		

12. Special Wear Items: Cost ÷ Life		
(See subsection 12A on back)		

13. TOTAL OPERATING COSTS (add lines 8, 9, 10a (or 10b), 11 and 12)		
--	--	--

14. MACHINE OWNING PLUS OPERATING (add lines 7 and 13)		
---	--	--

15. OPERATOR'S HOURLY WAGE (include fringes)		
--	--	--

16. TOTAL OWNING AND OPERATING COST		
---	--	--

SUBSECTION 2A: Residual Value at Replacement

Gross Selling Price	(1) (___%) _____	(2) (___%) _____
Less: a. Commission	_____	_____
b. Make-ready costs	_____	_____
c. Inflation during ownership period*	_____	_____
Net Residual Value	_____ (___%)	_____ (___%) of original delivered price
(Enter on line 2)		

*When used equipment auction prices are used to estimate residual value, the effect of inflation during the ownership period should be removed to show in constant value what part of the asset must be recovered through work.

SUBSECTION 9A: Lube Oils, Filters, Grease

	Unit Price	×	Consumption	=	Cost/Hour					
Engine	(1) _____	×	_____	=	_____	(2) _____	×	_____	=	_____
Transmission	_____	×	_____	=	_____	_____	×	_____	=	_____
Final Drives	_____	×	_____	=	_____	_____	×	_____	=	_____
Hydraulics	_____	×	_____	=	_____	_____	×	_____	=	_____
Grease	_____	×	_____	=	_____	_____	×	_____	=	_____
Filters	_____	×	_____	=	_____	_____	×	_____	=	_____
			Total	(1) _____	(2) _____					

(Enter total on line 9 or use Quick Estimator Tables)

SUBSECTION 12A: Special Items

(cutting edges, ground engaging tools, bucket teeth, excavator stick repair, etc.)

(1)	Cost	Life	Cost/Hour	(2)
1.	_____ ÷ _____	=	_____	1. _____ ÷ _____ = _____
2.	_____ ÷ _____	=	_____	2. _____ ÷ _____ = _____
3.	_____ ÷ _____	=	_____	3. _____ ÷ _____ = _____
4.	_____ ÷ _____	=	_____	4. _____ ÷ _____ = _____
5.	_____ ÷ _____	=	_____	5. _____ ÷ _____ = _____
6.	_____ ÷ _____	=	_____	6. _____ ÷ _____ = _____
		Total	(1) _____	(2) _____

(Enter total on line 12)

REPAIR RESERVE CONVERSION FACTORS (line 11)

For use in countries outside the United States where parts and service costs might differ from those used in charts and tables:

Labor Rate Ratio	(1) _____	(2) _____
Parts Cost Ratio	(1) _____	(2) _____

1-7

ESTIMATING OWNING COSTS*(Line Items 1 through 7)*

To protect his equipment investment and be able to replace it, the machine owner must recover over the machine's useful life an amount equal to the loss in resale value plus the other costs of owning the equipment including interest, insurance and taxes.

The machine owner, for accounting purposes, estimates resale value loss in advance, and recovers his original equipment investment by establishing depreciation schedules according to the various uses of the equipment. Proper financial and tax assistance is highly recommended when establishing depreciation schedules.

The machine depreciation method suggested in this handbook is not based on or related to any tax considerations, but rather is a simple straight line write-off based solely on the number of years or hours the owner expects to use the machine gainfully. Considering today's economic conditions worldwide and the trend toward larger, more expensive equipment, many users choose to keep these units on the job well after they have been fully depreciated for tax purposes. On the other hand, tax incentives in many areas may favor trading a machine well before it approaches the limits of its useful life.

Accordingly, it is imperative that careful consideration be given the selection of depreciation periods, and that for owning and operating cost calculations they be based on useful life rather than tax write-off life. The table of machine operating conditions (next page) only suggests such useful life periods in clock or operating hours. Recognize, however, that factors other than operating conditions can influence machine depreciation periods — an owner's wish to accelerate recovery of his investment, purchase of a machine for a job of specific duration, local customs, local economic conditions, availability of foreign exchange to buy a replacement, and many others.

Maintenance practices are not considered in this table but play an important part in determining economic machine life. For example, operating conditions may suggest a 12,000 hour depreciation period for a machine, but poor maintenance could make it uneconomical to retain the unit beyond 10,000 hours. Good, regular maintenance often can extend economical machine life.

Therefore, a knowledge of the intended use, operating conditions and maintenance practices, plus any special factors, is essential in establishing expected machine life for depreciation purposes.

GUIDE FOR SELECTING OWNERSHIP PERIOD BASED ON APPLICATION AND OPERATING CONDITIONS

	ZONE A Moderate	ZONE B Average	ZONE C Severe
TRACK-TYPE TRACTORS	Pulling scrapers, most agricultural drawbar, stockpile, coalpile. No impact. Intermittent full throttle operation.	Production dozing in clays, sands, gravels. Pushloading scrapers, borrow pit ripping, most landclearing applications. Medium impact conditions. Production landfill work.	Heavy rock ripping. Pushloading and dozing in hard rock. Work on rock surfaces. Continuous high impact conditions.
D3-D7R D8R/D9R D10R/D11R	12,000 Hr 45,000 Hr 50,000 Hr	10,000 Hr 35,000 Hr 40,000 Hr	8,000 Hr 25,000 Hr 30,000 Hr
AGRICULTURAL TRACTORS	Pulling combines, grain wagons and grain carts.	Pulling field cultivators, moldboard plows, chisel plows, discing, primary and finishing tillage.	Pulling layer scrapers, used in construction applications, ripping, dozing.
CHALLENGER 35, 45 & 55 CHALLENGER 65E-95E 'SR' TRACTORS	10,000 Hr 12,000 Hr 14,000 Hr	8,000 Hr 10,000 Hr 12,000 Hr	N/A 8,000 Hr 10,000 Hr
MOTOR GRADERS	Light road maintenance. Finishing. Plant and road mix work. Light snowplowing. Large amounts of traveling.	Haul road maintenance. Road construction, ditching, Loose fill spreading. Landforming, landleveling. Summer road maintenance with medium to heavy winter snow removal. Elevating grader use.	Maintenance of hard packed roads with embedded rock. Heavy fill spreading. Ripping-scarifying of asphalt or concrete. Continuous high load factor. High impact.
120H Thru 16H 24H	20,000 Hr 40,000 Hr	15,000 Hr 35,000 Hr	12,000 Hr 30,000 Hr
EXCAVATORS	Utility construction, low density material, rehandling and scrap handling applications.	Continuous digging in sandy clay/sandy gravel, site development and lumber yard applications.	Continuous digging in rock/natural bed clay, high impact, using hammer, working in forests or quarries.
M312-M320, 307, 307B 311B-318B L	10,000 Hr 12,000 Hr	8,000 Hr 10,000 Hr	6,000 Hr 8,000 Hr
EXCAVATORS	Shallow depth utility construction where excavator sets pipe and digs only 3 or 4 hours/shift. Free flowing, low density material and little or no impact. Most scrap handling arrangements.	Mass excavation or trenching where machine digs all the time in natural bed clay soils. Some traveling and steady, full throttle operation. Most log loading applications.	Continuous trenching or truck loading in rock or shot rock soils. Large amount of travel over rough ground. Machine continuously working on rock floor with constant high load factor and high impact.
320B, 322B, 325B, 330B 345B, 350, 375 5130B & 5230	15,000 Hr 15,000 Hr 20,000 Hr 60,000 Hr	12,000 Hr 12,000 Hr 18,000 Hr 50,000 Hr	10,000 Hr 10,000 Hr 15,000 Hr 40,000 Hr
FRONT SHOVELS	Continuous loading in loose banks or stockpile. Good underfoot conditions. (Might be considered similar to "normal" wheel loader conditions.)	Continuous loading in well-shot rock or fairly tight bank. Good underfoot conditions; dry floor, little impact or sliding on undercarriage.	Continuous loading in poorly-shot rock, virgin or lightly-blasted tight banks, e.g., shales, cemented gravels, caliches, etc. Adverse underfoot conditions: rough floors; high impact sliding on undercarriage.
5080 5130B & 5230	20,000 Hr 60,000 Hr	18,000 Hr 50,000 Hr	15,000 Hr 40,000 Hr

	ZONE A Moderate	ZONE B Average	ZONE C Severe
FELLER BUNCHERS	Continuous felling and stacking in good underfoot conditions. Flat ground uniform trees below 305 mm (12 inches). 18,000 Hr	Continuous cycling in good underfoot conditions. Rolling terrain, some trees up to 508 mm (20 inches) or some hardwoods. 15,000 Hr	Continuous cycling in steep terrain over stumps and fallen trees. Most trees 508 mm (20 inches) or larger hardwoods. 10,000 Hr
BACKHOE LOADERS	Light duty utility applications in light to medium soil. Trenching depths less 1.83 m (6 ft.) 12,000 Hr	Utility applications in medium to heavy soil. Occasional use of constant flow implements. Dig depths to 3.05 m (10 ft.) 10,000 Hr	Production applications or digging in rock. Regular use of constant flow implements. Dig depths over 3.05 m (10 ft.) 5,000 Hr
SKIDDERS	Intermittent skidding for short distances, no decking. Good underfoot conditions: level terrain, dry floor, few if any stumps.	Continuous turning, steady skidding for medium distances with moderate decking. Good underfooting: dry floor with few stumps and gradual rolling terrain.	Continuous turning, steady skidding for long distances with frequent decking. Poor underfoot conditions: wet floor, steep slopes and numerous stumps.
Wheel Track	10,000 Hr 12,000 Hr	8,000 Hr 10,000 Hr	7,200 Hr 8,000 Hr
PIPELAYERS	Little or no use in mud, water or on rock. Use on level, regular surfaces.	Typical pipelayer use in operating conditions ranging from very good to severe.	Continuous use in deep mud or water or on rock surfaces.
561-572 583-589	20,000 Hr 25,000 Hr	15,000 Hr 20,000 Hr	10,000 Hr 15,000 Hr
WHEEL TRACTOR- SCRAPERS	Level or favorable hauls on good haul roads. No impact. Easy-loading materials.	Varying loading and haul road conditions. Long and short hauls. Adverse and favorable grades. Some impact. Typical road-building use on a variety of jobs.	High impact condition, such as loading ripped rock. Overloading. Continuous high total resistance conditions. Rough haul roads.
613C Series II, 615C Series II 621F-627F,631E-657E	12,000 Hr 22,000 Hr	10,000 Hr 17,000 Hr	8,000 Hr 12,000 Hr
CONSTRUCTION & MINING TRUCKS & TRACTORS	Continuous operation at an average gross weight less than recommended. Excellent haul roads. No overloading, low load factor. (See Hourly Fuel Consumption section for definition).	Continuous operation at an average gross weight approaching recommended. Minimal overloading, good haul roads, moderate load factor. (See Hourly Fuel Consumption section for definition).	Continuous operation at or above maximum recommended gross weight. Overloading, poor haul roads, high load factor. (See Hourly Fuel Consumption section for definition). Note — Continual loading beyond recommended maximum gross weight will further reduce Zone C hours.
769D-777D 784C/785C/789C/793C	50,000 Hr 60,000 Hr	40,000 Hr 50,000 Hr	30,000 Hr 40,000 Hr

*Empty weight + payload.

	ZONE A Moderate	ZONE B Average	ZONE C Severe
ARTICULATED TRUCKS	Earthmoving and stockpile use with well matched loading equipment. Short to medium hauls on well-maintained level haul roads. Free flowing material. Few impact loads. 15,000 Hr	Varying load and haul road conditions. High rolling resistance and poor traction during part of the job. Some adverse grades. Some impact loads. Typical use in road-building, dam construction, open-pit mining, etc. 10,000 Hr	Continuous use on very poorly maintained haul roads, high rolling resistance and poor traction. Frequent adverse grades and high impact loads. Poorly-matched loading equipment with continuous over-loading. 8,000 Hr
WHEEL TRACTORS & COMPACTORS	Light utility work. Stockpile work. Pulling compactors. Dozing loose fill. No impact. 15,000 Hr	Production dozing, pushloading in clays, sands, silts, loose gravels. Shovel clean-up. 12,000 Hr	Production dozing in rock. Push-loading in rocky, bouldery borrow pits. High impact conditions. Land-fill compactor work. 8,000 Hr
WHEEL LOADERS	Intermittent truck loading from stockpile, hopper charging on firm, smooth surfaces. Free flowing, low density materials. Utility work in governmental and industrial applications. Light snowplowing. Load and carry on good surface for short distances with no grades. 914G-966F Series II 970F 980G-992G 994	Continuous truck loading from stockpile. Low to medium density materials in properly sized bucket. Hopper charging in low to medium rolling resistance. Loading from bank in good digging. Load and carry on poor surfaces and slight adverse grades. 10,000 Hr 10,000 Hr 12,000 Hr 50,000 Hr	Loading shot rock (large loaders). Handling high density materials with counterweighted machine. Steady loading from very tight banks. Continuous work on rough or very soft surfaces. Load and carry in hard digging; travel longer distances on poor surfaces with adverse grades. 8,000 Hr — 10,000 Hr 40,000 Hr
TRACK LOADERS	Site clearing of small vegetation, stripping top soil, carrying to stockpile. Intermittent truck loading from stockpile. Free flowing, low density materials with standard bucket. No impact. Backfilling and grading. 933C-939C 953C 963B-973	Bank excavation, intermittent ripping, basement digging of natural bed clays, sands, silts, gravels. Some traveling. Steady full throttle operation. 6,000 Hr 8,000 Hr 10,000 Hr	Loading shot rock, cobbles, glacial till, caliche. Steel mill work. High density materials in standard bucket. Continuous work on rock surfaces. Large amount of ripping of tight, rocky materials. High impact conditions. Not Recommended 6,000 Hr 8,000 Hr
INTEGRATED TOOLCARRIERS	Intermittent truck loading from stockpile, hopper charging on firm, smooth surfaces. Free flowing, low density materials. Utility work in governmental and industrial applications. Light snow-plowing. Load and carry on good surface for short distances with no grades. 12,000 Hr	Continuous truck loading from stockpile. Low to medium density materials in properly sized bucket. Hopper charging in low to medium rolling resistance. Loading from bank in good digging. Load and carry on poor surfaces and slight adverse grades. 10,000 Hr	Loading shot rock (large loaders). Handling high density materials with counterweighted machine. Steady loading from very tight banks. Continuous work on rough or very soft surfaces. Load and carry in hard digging; travel longer distances on poor surfaces with adverse grades. 8,000 Hr

- ① Delivered Price
- ② Residual Value at Replacement

AGRICULTURAL TRACTOR DEPRECIATION AND REPAIR COSTS

Unlike construction tractors which often are depreciated over 10,000 hours, the expected useful life of a Caterpillar steel tracked tractor in agriculture can range up to and beyond 20,000 hours (about eighteen years). The Challenger Tractor Line expected life is about 10,000 hours.

The tractor’s decline in value is always a significant portion of the machinery cost in farming. The actual market value of any tractor is determined by many variables ... machine age and condition, rate of change in size and farm operations in the area, popularity of given makes of tractors in the community, etc.

Whatever the variables, the decline in value is greater the first year than the second, greater the second year than the third, etc. The shorter the machine’s work life, the higher the percentage of its value lost in a year.

Although the percentage of loss each year depends on the life of the machine, it’s a general rule that 40 to 50% of the value will be lost in the first quarter of the machine’s life. By the halfway point of lifetime, from 70 to 75% of value will be lost.

The sum of digits is a common, easily used method for predicting the farm tractor’s depreciation value.

Assume a machine’s total life is 18 years. Assign each of those years a value, beginning with 18 for the first year, 17 for the second, 16 for the third, etc. The sum of all 18 digits is 171 which when divided into the initial new machine value, will give a specific monetary figure. The first year, 18 units of value are written off, 17 the second year, etc.

The resale value loss for the first four-year’s of machine life progresses as follows:

End of Year	Largest Remaining Digit	Loss of Value In Year	Loss of Value To Date	Remaining Value
1	18	18/171 or 10.5%	10.5%	89.5%
2	17	17/171 or 9.9%	(10.5 + 9.9) 20.4%	79.6%
3	16	16/171 or 9.3%	(20.4 + 9.3) 29.7%	70.3%
4	15	15/171 or 8.7%	(29.7 + 8.7) 38.4%	61.6%

Repairs — The reverse of the sum of digits formula can be used to predict repair costs for agricultural tractors.

Again, assuming an 18-year life, the sum of the digits would be 171. But the digit assigned the first year would be 1, the second year 2, etc.

(NOTE: The digital method applied to depreciation yields an eventual 100% of the purchase price. The American Society of Agricultural Engineers recommends repair costs for crawler tractors be figured at 78% and wheel tractors at 120% of purchase price.)

1 DELIVERED PRICE

(Line Item 1a, b and c)

Delivered price should include all costs of putting a machine on the user’s job including transportation and any applicable sales taxes.

On rubber tired machines, tires are considered a wear item and covered as an operating expense. Accordingly, some users may wish to deduct tire costs from the delivered price particularly for larger machines.

2 RESIDUAL VALUE AT REPLACEMENT

(Line Item 2 and Subsection 2A)

Any piece of earthmoving machinery will have some residual value at trade-in. While many owners prefer to depreciate their equipment to zero value, others recognize the residual resale or trade-in value. This is at the estimator’s option, but as in the discussion of depreciation, today’s higher equipment costs almost dictate that resale value be considered in determining the net depreciable investment. And if machines are traded early for tax incentive purposes, resale value becomes even more significant.

For many owners, potential resale or trade-in value is a key factor in their purchasing decisions, since this is a means of reducing the investment they must recover through depreciation charges. The high resale value of Caterpillar built machines can reduce hourly depreciation charges, lower total hourly owning costs and improve the owner’s competitive position.

Owning & Operating Costs

- ③ Value to be Recovered Through Work
- ④ Interest
- ⑤ Insurance
- ⑥ Taxes

When resale or trade-in value is used in estimating hourly owning and operating costs, local conditions must be considered, as used equipment values vary widely around the world. However, in any given used equipment business, factors which have greatest influence on resale or trade-in value are the number of hours on the machine at the time of sale or trade, the type of jobs and operating conditions in which it worked, and the physical condition of the machine. Your local Cat Dealer is your best source for determining current used equipment values.

Subsection 2A can be used to calculate the estimated residual value. If recent auction prices for used machines are used as a guide, then the value (or percentage) should be adjusted downward to remove the effect of inflation. Governmental indices on construction equipment costs or Dealer price records can be used to calculate the amount of inflation for the appropriate useful life. Another way to estimate residual value is comparing the current used machine value to the current new machine price provided major product changes haven't occurred.

3

VALUE TO BE RECOVERED THROUGH WORK

(Line Item 3a and b)

The delivered price less the estimated residual value results in the value to be recovered through work, divided by the total usage hours, gives the hourly cost to protect the asset's value.

4

INTEREST

(Line Item 4)

Many owners charge interest as part of hourly owning and operating costs, others consider it as general overhead in their overall operation. When charged to specific machines, interest is usually based on the owner's average annual investment in the unit.

Interest is considered to be the cost of using capital. The interest on capital used to purchase a machine must be considered, whether the machine is purchased outright or financed.

If the machine will be used for N years (where N is the number of years of use), calculate the average annual investment during the use period and apply the interest rate and expected annual usage:

$$\frac{\left[\frac{N + 1}{2N} \times \text{Delivered Price} \right] \times \text{Simple Interest \% rate}}{\text{hours/year}}$$

5-6

INSURANCE AND TAXES

(Line Items 5 and 6)

Insurance cost and property taxes can be calculated in one of two ways. If the specific annual cost is known this figure should be multiplied by the estimated usage (hours/years) and used. However, when the specific interest and tax costs for each machine are not known, the following formulas can be applied:

$$\frac{\text{Insurance}}{N = \text{No. Years}}$$

$$\frac{\left[\frac{N + 1}{2N} \times \text{Delivered Price} \right] \times \text{Insurance rate \%}}{\text{hours/year}}$$

$$\frac{\text{Property Tax}}{N = \text{No. Years}}$$

$$\frac{\left[\frac{N + 1}{2N} \times \text{Delivered Price} \right] \times \text{Tax rate \%}}{\text{hours/year}}$$

8-13

ESTIMATING OPERATING COSTS*(Line Items 8 through 13)*

8

FUEL CONSUMPTION*(Line Item 8)*

Fuel consumption can be closely measured in the field. However, if no opportunity exists to do this, consumption can be predicted when the machine application is known.

Application determines engine load factor which in turn controls engine fuel consumption. An engine continuously producing full rated horsepower is operating at a load factor of 1.0. Earthmoving machines may reach a 1.0 load factor intermittently, but seldom operate at this level for extended periods of time. Periods spent at idle, dozer and pusher travel in reverse, haul units traveling empty, close maneuvering at part throttle and operating downhill are examples of conditions which reduce load factor.

The following tables provide hourly fuel consumption estimates at various load factors for Caterpillar built machines. Since machine uses vary, application guides are also provided to aid in estimating load factor.

To estimate hourly fuel cost, select the load factor based on application and find hourly consumption. Then:

$$\text{Hourly consumption} \times \text{Local Unit Price of Fuel} = \text{Hourly Fuel Cost}$$

When using these tables, keep in mind the many variables which can affect fuel consumption. Two operators of different temperament or attitude operating identical machines side by side in the same material can have as much as 10-12% difference in their consumption rates. However, the ranges shown should be applicable across a wide spectrum of conditions. Your Caterpillar dealer representative can help select the most reasonable estimate for your specific situation; we suggest you call on him.

Keep in mind also that a fuel consumption study measured over a short period of operation will give higher fuel consumption than shown here because: (1) the study will be at 100% efficiency, without breaks or idle time, and (2) the operators will know they're "under the gun" to produce and look good. On the other hand, these tables allow for "normal" inefficiencies in the working cycle and will more closely relate to "normal" day to day operation.

- Track-Type Tractors
- Agricultural Tractors

FUEL CONSUMPTION TABLES & LOAD FACTOR GUIDES

TRACK-TYPE TRACTORS

Model	Low		Medium		High	
	liter	U.S. gal	liter	U.S. gal	liter	U.S. gal
D3C & LGP Series III	4-7½	1-2	7½-11	2-3	9½-13	2½-3½
D4C & LGP Series III	5½-9½	1½-2½	9½-13	2½-3½	11-15	3-4
D5C & LGP Series III	5½-9½	1½-2½	9½-13	2½-3½	13-17	3½-4½
D4E	5½-9½	1½-2½	9½-13	2½-3½	11-15	3-4
D5M XL & LGP	6-10½	1½-3	10½-14½	3-4	12½-17	3½-4½
D5B	9½-13	2½-3½	11-17	3-4½	15-21	4-5½
D6M XL & LGP	11-15	3-4	12½-19½	3½-5	17-24	4½-6½
D6G	11-20½	3½-5	15½-21	4-6	23-28½	6-7½
D6R XL, XR & LGP	13-22½	3½-6	17½-25	4½-6½	25-30½	6½-8½
D7G Series II*	19-25	5-6½	26-34	7-9	32-40	8½-10½
D7R XR & LGP	19-23	5-6	25-28	6½-7½	32-36	8½-10
D8R & LGP	23-28	6-7½	28-38	7½-10	38-51	10-13½
D9R	36-47	9½-12½	47-58	12½-15½	60-76	16-20
D10R	44-59	11½-15½	59-76	15½-20	76-93	20-24½
D11R	62-87	16½-23	87-112	23-29½	112-134	29½-35½

*D7G fuel consumption data is based on a precombustion chamber equipped engine. Fuel consumption for a direct injection equipped D7G should be approximately 10% less.

AGRICULTURAL TRACTORS

Model	Low		Medium		High	
	liter	U.S. gal	liter	U.S. gal	liter	U.S. gal
D4E SR	5½-9½	1½-2½	9½-13	2½-3½	11-15	3-4
D6G SR	11-19	3-5	15-21	4-5½	21-26	5½-7
Challenger 35	9½-21	2½-5½	21-32	5½-8½	32-42	8½-11
Challenger 45	9½-23	2½-6	23-38	6-10	38-45	10-12
Challenger 55	11-26	3-7	26-42	7-11	42-53	11-14
Challenger 65E	34-42	9-11	42-49	11-13	49-61	13-16
Challenger 75E	34-42	9-11	42-49	11-13	53-64	14-17
Challenger 85E	34-42	9-11	42-53	11-14	53-61	14-16
Challenger 95E	34-42	9-11	45-57	12-15	57-72	15-19

LOAD FACTOR GUIDE

High: Steady ripping, shuttle pushloading and downhill dozing. Agricultural drawbar work at full throttle, engine lugged to max. power most of the time. Little or no idling or travel in reverse.

Medium: Production dozing, pulling scrapers, most pushloading. Agricultural drawbar work at full throttle but not always lugging engine. Some idling and some travel with no load.

Low: Considerable idling or travel with no load.

⑧ Hourly Fuel Consumption Tables
 ● Motor Graders
 ● Excavators & Feller Bunchers

Owning & Operating Costs

MOTOR GRADERS

Model	Low		Medium		High	
	liter	U.S. gal	liter	U.S. gal	liter	U.S. gal
120H*	9-13	2.4-3.4	13-17	3.4-4.5	17-21	4.5-5.5
135H*	10-14	2.6-3.7	14-18	3.7-4.8	18-22	4.8-5.9
12H	11-16	2.9-4.2	16-21	4.2-5.5	21-26	5.5-6.7
140H*	12-17	3.1-4.4	17-22	4.4-5.7	22-26	5.7-7.0
143H**	12-17	3.2-4.6	17-22	4.6-5.9	22-28	5.9-7.3
160H*	14-20	3.7-5.3	20-26	5.3-6.8	26-32	6.8-8.4
163H**	14-21	3.8-5.4	20-27	5.4-7.0	27-33	7.0-8.6
14H	15-22	4.0-5.8	22-28	5.8-7.5	28-35	7.5-9.2
16H	19-27	5.0-7.1	27-35	7.1-9.2	35-43	9.2-11.3
24H	32-46	8.6-12.2	46-60	12.2-15.8	60-74	15.8-19.4

*Multiply consumption by 1.10 when equipped with Variable Horsepower or Engine Power Management.

**Multiply consumption by 1.15 when operating in All Wheel Drive.

LOAD FACTOR GUIDE

High: Ditching, fill spreading, spreading base material, ripping, heavy road maintenance, snow plowing.

Medium: Average road maintenance, road mix work, scarifying, snow plowing.

Low: Finish grading, light maintenance, road travel.

EXCAVATORS

Model	Low		Medium		High	
	liter	U.S. gal	liter	U.S. gal	liter	U.S. gal
301.5	*	*	*	*	*	*
307/307B	3-5	¾-1¼	5-8	1¼-2	7-10	1¼-2½
311B	4-6	1-1½	6-9	1½-2¼	9-12	2¼-3½
312B/312B L	4-6	1-1½	6-10	1½-2½	10-13	2½-3½
315B	5-9	1¼-2¼	9-13	2¼-3½	13-15	3½-4
318B L	*	*	*	*	*	*
M312	5-9	1¼-2¼	9-12	2¼-3½	12-15	3½-4
M315	6-10	1¼-2½	10-13	2½-3½	13-16	3½-4½
M318	8-12	2-3½	12-16	3½-4	17-19	4½-5
M320	9-13	2-3½	13-17	3½-4½	17-20	4½-5½
320B	9-13	2½-3½	13-15	3½-4	15-19	4-5
322B	11-15	3-4	16-18	4¼-4¾	18-23	4¾-6¼
325B	13-16	3½-4¼	18-21	4¾-5½	25-27	6¾-7¼
330B	18-24	4¾-6½	24-30	6½-8	34-38	9-10
345B	25-30	5½-8	35-40	9¼-10½	45-50	11¼-13¼
350	23-28	6-7½	32-37	8½-9¾	47-53	12½-14
375	33-38	8¾-10	42-48	11-12¾	61-67	16-17¾
5130B	91-95	24-25	110-114	29-30	129-132	34-35
5230	163-193	43-51	193-204	51-54	208-227	55-60

*Insufficient data.

LOAD FACTOR GUIDE

High: Most pipeline applications in hard rocky material. Digging 90-95% of the daily work schedule.

Medium: Most residential sewer applications in natural bed clay. Digging 60-85% of the daily work schedule. Most log loading applications.

Low: Most utility, urban applications in sandy loam. Digging less than 50% of the daily work schedule. Scrap handling applications.

Owning & Operating Costs

⑧ Hourly Fuel Consumption Tables

- Front Shovels
- Pipelayers
- Wheel Tractor-Scrapers

FRONT SHOVELS

Model	Low		Medium		High	
	liter	U.S. gal	liter	U.S. gal	liter	U.S. gal
5080	36-42	10-11	46-53	12-14	62-74	18-20
5130B	91-95	24-25	110-114	29-30	129-132	34-35
5230	163-193	43-51	193-204	51-54	208-227	55-60

LOAD FACTOR GUIDE

High: Steady cycling in hard to dig material.

Medium: Steady cycling with frequent periods at idle.

Low: Light easy work. Considerable idling.

PIPELAYERS

Model	Low		Medium		High	
	liter	U.S. gal	liter	U.S. gal	liter	U.S. gal
561M	4-7½	1-2	7½-11	2-3	9½-13	2½-3½
572R	7½-11	2-3	13-17	3½-4½	17-21	4½-5½
583R	9½-13	2½-3½	16½-20	4½-5½	22½-26	6½-7½
589	17-21	4½-5½	26-30	7-8	34-40	9-10½

LOAD FACTOR GUIDE

Pipelayer load factor depends largely on amount of time spent at idle speed.

WHEEL TRACTOR-SCRAPERS

Model	Low		Medium		High	
	liter	U.S. gal	liter	U.S. gal	liter	U.S. gal
613C Series II	15-19	4-5	21-25	5½-6½	27½-34	7¼-9
615C Series II	23-26	6-7	30-36	8-9½	42-47½	11-12½
621F	27-32	7-8½	38-44	10-11½	49-57	13-15
623F	30-36	8-9½	40-46	10½-12	53-59	14-15½
627F	45½-51	12-13½	64-70	17-18½	85-89½	22½-23½
631E Series II	40-45	10½-12	53-59	14-15½	72-78	19-20½
633E Series II	45-49	12-13	56-62	15-16½	78-81	20½-21½
637E Series II	64-70	17-18½	87-93	23-24½	113½-121	30-32
651E	47-57	12½-15	66-76	17½-20	87-95	23-25
657E	87-98	23-26	116-125½	30½-33	153-163	40½-43

LOAD FACTOR GUIDE

High: Continuous high total resistance conditions with steady cycling.

Medium: Typical road building use.

Low: Average use but with considerable idling, favorable grades, low rolling resistance and easy loading material.

BACKHOE LOADERS

Model	Low		Medium		High	
	liter	U.S. gal	liter	U.S. gal	liter	U.S. gal
416C (NA)	4.5-6.4	1.2-1.7	6.4-8.3	1.7-2.2	8.3-10.2	2.2-2.7
428C (NA)	4.5-6.4	1.2-1.7	6.4-8.3	1.7-2.2	8.3-10.2	2.2-2.7
416C (T)	5.3-7.2	1.4-1.9	7.2-9.1	1.9-2.4	9.1-11.4	2.4-3.0
428C (T)	5.3-7.2	1.4-1.9	7.2-9.1	1.9-2.4	9.1-11.4	2.4-3.0
426C	5.3-7.2	1.4-1.9	7.2-9.1	1.9-2.4	9.1-11.4	2.4-3.0
436C	6.1-8.3	1.6-2.2	8.3-10.2	2.2-2.7	10.2-12.5	2.7-3.3
438C	6.1-8.3	1.6-2.2	8.3-10.2	2.2-2.7	10.2-12.5	2.7-3.3
446B	7.6-9.8	2.0-2.6	9.8-12.1	2.6-3.2	12.1-14.4	3.2-3.8

NA = Naturally Aspirated
 T = Turbocharged

LOAD FACTOR GUIDE

High: Production work with long cycles and/or constant flow implements.
 Medium: General work with regular cycles in medium applications.
 Low: Utility work with intermittent cycles in light to medium applications.

SKIDDERS

Model	Low		Medium		High	
	liter	U.S. gal	liter	U.S. gal	liter	U.S. gal
515	9-12	2½-3¼	12-16	3¼-4¼	16-22	4¼-5¼
525	10-14	2¾-3¾	14-18	3¾-4¾	18-25	4¾-6½
528B	13-17	3½-4½	19-23	5-6	23-28	6-7½
517	7-13	1½-3½	13-18	3½-5	15-21	4-5½
527	14-19	3¾-5	19-24	5-6¼	24-32	6¼-8½

LOAD FACTOR GUIDE — 515

High: Skidding loads over 4536 kg (10,000 lb) in steep terrain (over 10%) with high skidding resistance.
 Medium: Skidding loads up to 4536 kg (10,000 lb) in medium (5-10%) terrain with average skidding resistance.
 Low: Skidding loads less than 2720 kg (6000 lb) in flat terrain (0-5%) with low skidding resistance.

LOAD FACTOR GUIDE — 525

High: Skidding loads over 6800 kg (15,000 lb) in steep terrain (over 10%) with high skidding resistance.
 Medium: Skidding loads up to 6800 kg (15,000 lb) in moderate terrain (5-10%) with average skidding resistance.
 Low: Skidding loads less than 4500 kg (10,000 lb) in flat terrain (0-5%) with low skidding resistance.

LOAD FACTOR GUIDE — 528B

High: Skidding loads over 11 300 kg (25,000 lb) in steep terrain (over 10%) with high skidding resistance.
 Medium: Skidding loads up to 11 300 kg (25,000 lb) in moderate terrain (5-10%) with average skidding resistance.
 Low: Skidding loads less than 6800 kg (15,000 lb) in flat terrain (0-5%) with low skidding resistance.

LOAD FACTOR GUIDE — 517

High: Skidding loads over 4536 kg (10,000 lb) in steep terrain (over 30%) with high skidding resistance.
 Medium: Skidding loads up to 4536 kg (10,000 lb) in moderate terrain (8-30%) with medium skidding resistance.
 Low: Skidding loads less than 4536 kg (10,000 lb) in flat terrain (0-8%) with low skidding resistance.

LOAD FACTOR GUIDE — 527

High: Skidding loads over 6360 kg (14,000 lb) in steep terrain (over 30%) with high skidding resistance.
 Medium: Skidding loads up to 6360 kg (14,000 lb) in moderate terrain (8-30%) with medium skidding resistance.
 Low: Skidding loads less than 6360 kg (14,000 lb) in flat terrain (0-8%) with low skidding resistance.

Owning & Operating Costs

- ⑧ Hourly Fuel Consumption Tables
- Construction & Mining Trucks/Tractors
 - Articulated Dump Trucks ● Telehandlers

CONSTRUCTION & MINING TRUCKS & TRACTORS

Model	Low		Medium		High	
	liter	U.S. gal	liter	U.S. gal	liter	U.S. gal
769D	20.8-30.3	5½-8	30.3-40	8-10½	40-68	10½-14
771D	22.7-32.2	6-8½	32.2-41.6	8½-11	41.6-55	11-14½
773D	24.5-36	6½-9½	36-53	9½-14	53-68	14-18
775D	30.3-41.6	8-11	41.6-56.8	11-15	56.8-73.8	15-19½
776D	53.0-73.8	14-19½	73.8-96.5	19½-25½	96.5-117.3	25½-31
777D	36.0-53.0	9½-14	53.0-73.8	14-19½	73.8-96.5	19½-25½
784C/785C	53.0-79.5	14-21	79.5-109.8	21-29	100.8-145.7	29-38½
789C	68.1-102.2	18-27	102.2-141.9	27-37½	141.9-185.5	37½-49
793C	86-129	23-34	129-172	34-45½	172-215	45½-57

NOTE: Load factors above 50% may be experienced in many applications.

LOAD FACTOR GUIDE

Low: 20%-30% Medium: 30%-40% High: 40%-50%

ARTICULATED TRUCKS

Model	Low		Medium		High	
	liter	U.S. gal	liter	U.S. gal	liter	U.S. gal
D25D	13.1-18.3	3.5-4.8	18.3-25.7	4.8-6.8	25.7-37.1	6.8-9.8
D30D	14.7-20.4	3.9-5.4	20.4-28.7	5.4-7.6	28.7-41.5	7.6-11.0
D250E	13.2-18.3	3.5-4.8	18.3-25.8	4.8-6.8	25.8-37.2	6.8-9.8
D300E	14.2-19.7	3.7-5.2	19.7-27.7	5.2-7.3	27.7-40.0	7.3-10.6
D350E	15.9-22.2	4.2-5.9	22.2-31.2	5.9-8.2	31.2-45.0	8.2-11.9
D400E	17.6-24.5	4.6-6.5	25.2-35.4	6.7-9.4	36.1-52.2	9.6-13.8

LOAD FACTOR GUIDE

High: Long haul time with frequent adverse grades. Continuous use on very poorly maintained haul roads with high rolling resistance.

Medium: Normal load and haul time. Varying load and haul road conditions. Some adverse grades. Some high rolling resistance.

Low: Large amount of idling. Short to medium hauls on well maintained level haul roads. Minimum total resistance.

TELEHANDLERS

Model	Intermittent		Continuous	
	liter	U.S. gal	liter	U.S. gal
TH62 NA	11.00	2.90	16.00	4.22
TH62 T	14.20	3.75	19.60	5.17
TH63 NA	11.00	2.90	16.00	4.22
TH63 T	14.20	3.75	19.60	5.17
TH82 NA	11.00	2.90	16.00	4.22
TH82 T	14.20	3.75	19.60	5.17
TH83 T	14.20	3.75	19.60	5.17

LOAD FACTOR GUIDE

Continuous: Continuous loading/cycling applications.

Intermittent: Average loading/cycle applications with periods at idle.

⑧ Hourly Fuel Consumption Tables
 ● Wheel Tractors & Compactors
 ● Compaction Equipment

Owning & Operating Costs

WHEEL TRACTORS & COMPACTORS

Model	Low		Medium		High	
	liter	U.S. gal	liter	U.S. gal	liter	U.S. gal
814F	21-25	5½-6½	26-30	7-8	36-40	9½-10½
815F	26-30	7-8	36-42	9½-11	44-47	11½-12½
816F	26-30	7-8	36-42	9½-11	44-47	11½-12½
824G	28-32	7½-8½	38-44	10-11½	51-57	13½-15
825G	36-42	9½-11	51-57	13½-15	60-66	16-17½
826G	36-42	9½-11	51-57	13½-15	60-66	16-17½
834B	40-45	10½-12	53-59	14-15½	72-78	19-20½
836	40-45	10½-12	52-59	13-15½	72-78	19-20½
844	45-53	12-14	60½-68	16-18	79½-87	21-23
854G	58-66	15-17	83-91	22-24	116-125	30-33

LOAD FACTOR GUIDE

High: Heavy dozing, compacting heavy material. Heavy landfill work.

Medium: Production dozing, most pushloading, shovel cleanup, normal compaction.

Low: Considerable idling or travel with no load.

COMPACTION EQUIPMENT

Model	Low		Medium		High	
	liter	U.S. gal	liter	U.S. gal	liter	U.S. gal
CS-323C	8-11	2-3	11-13	3-3½	11-15	3-4
CS-431C	8-11	2-3	11-13	3-3½	11-15	3-4
CS-433C	11	3	11-13	3-3½	13-15	3½-4
CS-563C	13	3½	13-15	3½-4	15-21	4-5½
CS-573	13	3½	13-15	3½-4	15-21	4-5½
CS-583C	15-17	4-4½	17-19	4½-5	19-23	5-6
CP-323C	9-13	2½-3½	13-15	3½-4	15-19	4-5
CP-433C	13	3½	15-17	4-4½	17-19	4½-5
CP-533C	15	4	17-19	4½-5	19-25	5-6½
CP-563C	15	4	17-19	4½-5	21-25	5½-6½
CB-214C	6-8	1½-2	8-9	2-2½	9-13	2½-3½
CB-224C	8	2	9-11	2½-3	11-15	3-4
CB-434C	11-13	3-3½	13-17	3½-4½	17-19	4½-5
CB-534C	13	3½	15-17	4-4½	17-23	4½-6
CB-535B	13	3½	15-17	4-4½	17-23	4½-6
CB-544	11-13	3-3½	13-17	3½-4½	17-19	4½-5
CB-545	11-13	3-3½	13-17	3½-4½	17-19	4½-5
CB-634C	13-15	3½-4	15-19	4-5	19-21	5-5½
PF-300B	13	3½	15-17	4-4½	17-23	4½-6
PS-300B	13	3½	15-17	4-4½	17-23	4½-6
PS-500	13-15	3½-4	15-19	4-5	19-21	5-5½

LOAD FACTOR GUIDE

High: Vibration 80-100%, heavy cohesive soil, 305 mm (12") lifts or more.

Medium: Vibration 50-80%, granular soil, 100 mm-305 mm (4"-12") lifts.

Low: Vibration 30-50%, asphalt mix, 51 mm-305 mm (2"-4") lifts.

ASPHALT PAVERS

Model	Low		Medium		High	
	liter	U.S. gal	liter	U.S. gal	liter	U.S. gal
BG-201B	11-13	3-3½	13-15	3½-4	15-19	4-5
AP-800C	11-15	3-4	15-19	4-5	17-19	4½-5
AP-1000B	18-20	4¾-5¼	22-24	5¾-6¼	25-27	6½-7¼
AP-650B	11-15	3-4	15-19	4-5	19-21	5-5½
AP-1050B	19-21	5-5½	23-25	6-6½	26-28	6¾-7½
AP-1055B	19-21	5-5½	23-25	6-6½	26-28	6¾-7½
BG-650	11-13	3-3½	13-17	3½-4½	17-19	4½-5
BG-730	13-17	3½-4½	17-19	4½-5	19-25	5-6½

LOAD FACTOR GUIDE

High: Wide width, deep lift paving.

Medium: 3-4 m (10'-12') width, 50-75 mm (2"-3") lift.

Low: Narrow width paving — low production.

WHEEL LOADERS & INTEGRATED TOOLCARRIERS

Model	Low		Medium		High	
	liter	U.S. gal	liter	U.S. gal	liter	U.S. gal
902	*	*	*	*	*	*
906	*	*	*	*	*	*
914G, IT14G	5-6½	1-2	8-10½	2-2¾	11½-13	3-3½
924F, IT24F	5½-7½	1½-2	9½-12	2½-3	13-15	3½-4
928G, IT28G	7½-11	2-3	11-15	3-4	15-19	4-5
938G, IT38G	9-12½	2-3	13-17	3½-4½	18-22	4¾-5¾
950G	11-15	3-4	17-21	4½-5½	23-28	6-7½
962G, IT62G	12-16	3-4	18-22	5-6	24-29	6½-8
966F Series II	17-21	4½-5½	23-28	6-7½	32-38	8½-10
970F	19-23	5-6	25-30	6½-8	35-41	9-11
980G	23-26	6-7	30-36	8-9½	42-47	11-12½
988F Series II	32-38	8½-10	44-49	11½-13	60-66	16-17½
990 Series II	45-53	12-14	60½-68	16-18	79½-87	21-23
992G	58-66	15-17	83-91	22-24	116-125	30-33
994	102-109½	27-29	129-144	34-38	163-178	43-47

*Insufficient data.

LOAD FACTOR GUIDE

High: Steady cycling on basic loader cycle.

Medium: Steady cycling but over haul distances or work on basic loader cycle with frequent periods at idle.

Low: Light utility work. Considerable idling.

TRACK LOADERS

Model	Low		Medium		High	
	liter	U.S. gal	liter	U.S. gal	liter	U.S. gal
933C	3½-7½	1-2	7½-11	2-3	9½-13	2½-3½
939C	5½-9½	1½-2½	9½-13	2½-3½	13-17	3½-4½
953C	9½-13	2½-3½	15-19	4-5	19-23	5-6
963B	13-17	3½-4½	19-23	5-6	23-28	6-7½
973	19-23	5-6	28-34	7½-9	36-42	9½-11

LOAD FACTOR GUIDE

High: Continuous excavating and loading from bank. Land clearing.

Medium: Bank or stockpile loading with idling periods. Load and carry.

Low: Large amounts of idling in any application.

9

LUBE OILS, FILTERS, GREASE

(Line Item 9 and Subsection 9A)

Hourly costs of lube oils and grease can be approximately estimated by taking consumptions from the table below and applying local prices.

See the page following this table for instructions on how to estimate local hourly filter costs.

For quick estimating, *approximate* hourly costs in U.S. dollars for the total lube oils, filters and grease for each machine are shown in the last table in this area.

APPROXIMATE HOURLY CONSUMPTION OF LUBRICANTS
(When operating in heavy dust, deep mud or water, increase the quantities by 25%.)

Model	Crankcase		Transmission		Final Drives		Hydraulic Control		Lubricant Changes*	Grease Fittings**
	liter	U.S. gal	liter	U.S. gal	liter	U.S. gal	liter	U.S. gal		
Track-Type Tractors										
D3C/D4C Series III	0.045	0.012	0.011	0.003	0.009	0.002	0.015	0.004	16	320
D5C Series III	0.045	0.012	0.011	0.003	0.012	0.003	0.015	0.004	16	320
D4E	0.076	0.020	0.039	0.010	0.018	0.005	0.011	0.003	11	864
D5M	0.076	0.020	0.120	0.032	0.006	0.002	0.018	0.005	12	336
D5B	0.108	0.029	0.076	0.020	0.022	0.006	0.024	0.006	9	916
D6M	0.104	0.027	0.120	0.032	0.007	0.002	0.015	0.004	11	152
D6G	0.108	0.029	0.095	0.025	0.038	0.010	0.025	0.006	12	132
D6R	0.110	0.029	0.144	0.038	0.013	0.003	0.023	0.006	13	32
D7G	0.110	0.029	0.070	0.019	0.034	0.009	0.046	0.012	14	560
D7R	0.110	0.029	0.129	0.034	0.019	0.005	0.030	0.008	10	20
D8R	0.129	0.034	0.144	0.038	0.015	0.004	0.038	0.010	13.7	580
D9R	0.181	0.048	0.163	0.043	0.015	0.004	0.038	0.010	13.3	580
D10R	0.242	0.064	0.189	0.050	0.022	0.006	0.054	0.014	13.3	628
D11R	0.424	0.112	0.344	0.091	0.030	0.008	0.102	0.027	13.3	816
Agricultural Tractors										
D4E SR	0.038	0.010	0.039	0.010	0.018	0.005	0.011	0.003	11	864
D6G SR	0.109	0.029	0.045	0.012	0.038	0.010	0.024	0.006	13	428
Challenger 35	0.130	0.034	0.121	0.032	***	***	***	***	10	320
Challenger 45	0.130	0.034	0.121	0.032	***	***	***	***	10	320
Challenger 55	0.130	0.034	0.121	0.032	***	***	***	***	10	320
Challenger 65E	0.104	0.027	0.055	0.015	0.197	0.052	0.110	0.029	14	12
Challenger 75E	0.136	0.036	0.055	0.015	0.197	0.052	0.120	0.032	14	12
Challenger 85E	0.136	0.036	0.055	0.015	0.197	0.052	0.120	0.032	14	12
Challenger 95E	0.136	0.036	0.055	0.015	0.197	0.052	0.120	0.032	14	12
Motor Graders										
120H	0.092	0.024	0.047	0.012	0.049	0.013	0.019	0.005	12	876
135H	0.092	0.024	0.047	0.012	0.061	0.016	0.019	0.005	12	876
12H	0.108	0.029	0.047	0.012	0.065	0.017	0.019	0.005	12	876
140H	0.108	0.029	0.047	0.012	0.065	0.017	0.019	0.005	12	876
143H	0.108	0.029	0.047	0.012	0.065	0.017	0.019	0.005	12	876
160H	0.108	0.029	0.047	0.012	0.080	0.021	0.019	0.005	12	876
163H	0.108	0.029	0.047	0.012	0.080	0.021	0.019	0.005	12	876
14H	0.108	0.029	0.083	0.022	0.098	0.026	0.032	0.015	12	916
16H	0.136	0.036	0.140	0.037	0.121	0.032	0.032	0.015	12	916
24H	0.272	0.072	0.224	0.060	0.330	0.087	0.127	0.034	20	2056

*Total number of lubricant changes (crankcase, transmission, final drives and hydraulic) over a 2000 hour period. Total may vary depending upon the sulfur content of your diesel fuel. Always consult your machine's Lube and Maintenance Guide.

**Total number of grease fittings you can expect to service over a 2000 hour period. Total can vary depending upon how your machine is equipped.

***Common sump with transmission.

NOTE: These figures are based upon machines operating in ideal conditions without loss of lubricants. They were computed by dividing recommended change intervals (in hours) into tank capacity. Make-up quantities are *not* included in these computations.

APPROXIMATE HOURLY CONSUMPTION OF LUBRICANTS

Model	Crankcase		Transmission†		Final Drives††		Hydraulic Control		Lubricant Changes*	Grease Fittings**
	liter	U.S. gal	liter	U.S. gal	liter	U.S. gal	liter	U.S. gal		
Excavators & Front Shovels	**	**	**	**	**	**	**	**	**	**
301.5	0.041	0.011	—	—	0.003	0.001	0.053	0.014	15	777
307	0.032	0.008	—	—	0.003	0.001	0.047	0.012	15	969
307B	0.032	0.008	—	—	0.003	0.001	0.047	0.012	15	1067
307B SB	0.059	0.016	—	—	0.005	0.001	0.079	0.021	15	863
311B	0.059	0.016	—	—	0.005	0.001	0.081	0.021	15	863
312B	0.060	0.016	—	—	0.005	0.001	0.094	0.025	15	863
312B L	0.017	0.004	—	—	0.005	0.001	0.076	0.020	11	863
312B/312B L*	0.059	0.016	—	—	0.005	0.001	0.094	0.025	15	912
315B	0.034	0.009	—	—	0.006	0.001	0.094	0.025	14	912
315B L*	0.059	0.016	—	—	0.005	0.001	0.094	0.025	15	912
318B L/318B LN	0.034	0.009	0.03	0.008	0.008	0.002	0.058	0.015	17	1088
M312	0.034	0.009	0.03	0.008	0.008	0.002	0.058	0.015	17	1088
M315	0.080	0.021	0.03	0.008	0.008	0.002	0.067	0.018	17	1088
M318	0.080	0.021	0.03	0.008	0.008	0.002	0.067	0.018	17	1088
M320	0.092	0.024	—	—	0.020	0.005	0.110	0.029	15	912
320B (3066)	0.084	0.022	—	—	0.020	0.005	0.096	0.025	11	910
320 (3116)	0.086	0.023	—	—	0.020	0.005	0.133	0.035	14	910
322B	0.080	0.021	—	—	0.016	0.004	0.155	0.041	14	910
325B	0.120	0.032	—	—	0.030	0.007	0.200	0.053	14	926
330B	0.136	0.036	—	—	0.030	0.007	0.260	0.069	14	926
345B	0.120	0.032	—	—	0.016	0.004	0.265	0.070	12	1975
350	0.260	0.069	—	—	0.050	0.013	0.498	0.132	14	1991
375	0.260	0.069	—	—	0.050	0.013	0.498	0.132	11	1492
5080 FS	0.364	0.096	0.077	0.020	0.392	0.103	0.600	0.159	20	Auto-Lube*
5130B FS	0.364	0.096	0.077	0.020	0.392	0.103	0.600	0.159	20	2800 +
5130B ME	0.760	0.200	0.090	0.024	0.499	0.131	0.830	0.169	22	Auto-Lube*
5230 FS	0.760	0.200	0.090	0.024	0.499	0.131	0.830	0.169	22	2800 +
5230 ME										Auto-Lube*

*France sourced.

**Insufficient data.

NOTE: ME includes manual hose reel for bucket pin lube.

AUTO LUBE* APPROXIMATE HOURLY CONSUMPTION OF GREASE

Model	Kg/hr Grease	lb./hr Grease	Grease Canister Refills*	Auto Lube Interval (minutes)	Number Of Injectors	Grease Canister Size (lb.)
5130B FS	0.34	0.75	13	10	48	120
5130B ME	0.27	0.60	10	10	36	120
5230 FS	0.47	1.04	5	10	48	400
5230 ME	0.33	0.73	4	10	38	400

*Total number of times you can expect to refill the auto lube grease canister in a 2000 hour period.

NOTE: These figures are based on auto lube system as set from the factory.

APPROXIMATE HOURLY CONSUMPTION OF LUBRICANTS

Model	Crankcase		Transmission†		Final Drives††		Hydraulic Control		Lubricant Changes*	Grease Fittings**
	liter	U.S. gal	liter	U.S. gal	liter	U.S. gal	liter	U.S. gal		
Backhoe Loaders										
416C	0.017	0.004	0.010	0.002	0.018	0.005	0.015	0.004	11	8012
426C	0.017	0.004	0.010	0.002	0.018	0.005	0.015	0.004	11	8012
428C	0.017	0.004	0.010	0.002	0.018	0.005	0.015	0.004	11	8012
436C	0.017	0.004	0.010	0.002	0.018	0.005	0.015	0.004	11	8012
438C	0.017	0.004	0.010	0.002	0.018	0.005	0.015	0.004	11	8012
446B	0.027	0.006	0.026	0.005	0.029	0.008	0.022	0.006	11	8092

*Total number of lubricant changes (crankcase, transmission, final drives and hydraulic) over a 2000 hour period. Total may vary depending upon the sulfur content of your diesel fuel. Always consult your machine's Lube and Maintenance Guide.

**The number shown here refers to the total number of grease fittings you can expect to service over a 2000 hour period. Total can vary depending upon how your machine is equipped.

†Includes hydraulic pump drive (Excavators).

††Includes travel drives and swing drive (Excavators).

APPROXIMATE HOURLY CONSUMPTION OF LUBRICANTS

Model	Crankcase		Transmission		Final Drives†		Hydraulic Control††		Lubricant Changes*	Grease Fittings**
	liter	U.S. gal	liter	U.S. gal	liter	U.S. gal	liter	U.S. gal		
Skidders										
515/525	0.076	0.020	0.053	0.014	0.045	0.012	0.034	0.009	13	2436
528B	0.113	0.030	0.032	0.008	0.032	0.008	0.023	0.006	12	584
517	0.034	0.009	0.117	0.031	0.014	0.003	0.023	0.006	12	2336
527	0.044	0.011	0.132	0.034	0.014	0.003	0.034	0.009	11	2152
Pipelayers										
561M	0.102	0.027	0.106	0.028	0.006	0.002	0.030	0.008	16	3400
572G	0.132	0.035	0.117	0.031	0.038	0.010	0.072	0.019	13	3632
578	0.132	0.035	0.155	0.041	0.011	0.003	0.083	0.022	14	2268
589	0.171	0.045	0.167	0.044	0.023	0.006	0.114	0.030	16	2464
Wheel-Tractor Scrapers										
613C Series II	0.102	0.027	0.024	0.009	0.016	0.004	0.049	0.013	12	5820
615C Series II	0.094	0.025	0.034	0.009	0.030	0.008	0.079	0.021	12	9004
621F	0.106	0.028	0.083	0.022	0.106	0.028	0.068	0.018	13	1326
623F	0.106	0.028	0.083	0.022	0.106	0.028	0.068	0.018	13	5448
627F	0.250	0.006	0.144	0.038	0.098	0.026	0.072	0.019	22	1326
631E Series II	0.182	0.048	0.127	0.033	0.092	0.024	0.085	0.022	12	1368
633E Series II	0.182	0.048	0.127	0.033	0.092	0.024	0.085	0.022	12	5488
637E Series II	0.290	0.077	0.185	0.049	0.164	0.043	0.085	0.022	22	1368
651E	0.272	0.072	0.136	0.036	0.098	0.026	0.094	0.025	12	1552
657E	0.454	0.120	0.257	0.048	0.182	0.048	0.094	0.025	24	2088

*Total number of lubricant changes (crankcase, transmission, final drives and hydraulic) over a 2000 hour period. Total may vary depending upon the sulfur content of your diesel fuel. Always consult your machine's Lube and Maintenance Guide.

**The number shown here refers to the total number of grease fittings you can expect to service over a 2000 hour period. Total can vary depending upon how your machine is equipped.

†Includes differential (Construction & Mining Trucks/Tractors, Wheel Loaders and Articulated Trucks).

††Includes brakes, converter hoist system and steering system (Construction & Mining Trucks/Tractors).

NOTE: Lubricant changes shown for the tandem powered 627F, 637E Series II and 657E include both tractor and scraper engines.

APPROXIMATE HOURLY CONSUMPTION OF LUBRICANTS

Model	Crankcase		Transmission		Final Drives†		Hydraulic Control††		Lubricant Changes*	Grease Fittings**
	liter	U.S. gal	liter	U.S. gal	liter	U.S. gal	liter	U.S. gal		
Construction/Mining Trucks/Tractors										
769D	0.182	0.048	0.083	0.022	0.083	0.022	0.276	0.073	20	552
771D	0.182	0.048	0.083	0.022	0.083	0.022	0.276	0.073	20	552
773D	0.273	0.072	0.083	0.022	0.155	0.041	0.276	0.073	20	552
775D	0.273	0.072	0.083	0.022	0.155	0.041	0.276	0.073	20	552
776D	0.500	0.132	0.083	0.022	0.326	0.086	0.302	0.080	20	1056
777D	0.500	0.132	0.083	0.022	0.326	0.086	0.302	0.080	20	632
784C	0.531	0.140	0.076	0.020	0.292	0.077	0.337	0.101	16.7	Auto Lube*
785C	0.531	0.140	0.076	0.020	0.292	0.077	0.337	0.101	16.7	Auto Lube*
789C	0.796	0.210	0.076	0.020	0.375	0.099	0.531	0.157	16.7	Auto Lube*
793C	0.584	0.154	0.076	0.020	0.445	0.118	0.580	0.170	12.7	Auto Lube*

*Total number of lubricant changes (crankcase, transmission, final drives and hydraulic) over a 2000 hour period. Total may vary depending upon the sulfur content of your diesel fuel. Always consult your machine's Lube and Maintenance Guide.

**The number shown here refers to the total number of grease fittings you can expect to service over a 2000 hour period. Total can vary depending upon how your machine is equipped.

†Includes differential (Construction & Mining Trucks/Tractors, Wheel Loaders and Articulated Trucks).

††Includes brakes, converter hoist system and steering system (Construction & Mining Trucks/Tractors).

NOTE: Lubricant changes shown for the tandem powered 627F, 637E Series II and 657E include both tractor and scraper engines.

AUTO LUBE* APPROXIMATE HOURLY CONSUMPTION OF GREASE

Model	Kg/hr Grease	lb./hr Grease	Grease Canister Refills*	Auto Lube Interval (minutes)	Number Of Injectors	Grease Canister Size (lb.)
784C/785C	0.022	0.010	1	60	27	60
789C	0.022	0.010	1	60	27	60
793C	0.023	0.011	1	60	29	60

*Total number of times you can expect to refill the auto lube grease canister in a 2000 hour period.

NOTE: These figures are based on auto lube system as set from the factory.

APPROXIMATE HOURLY CONSUMPTION OF LUBRICANTS

Model	Crankcase		Transmission		Final Drives†		Hydraulic Control††		Lubricant Changes*	Grease Fittings**
	liter	U.S. gal	liter	U.S. gal	liter	U.S. gal	liter	U.S. gal		
Articulated Trucks										
D25D	0.110	0.029	0.065	0.017	0.080	0.021	0.135	0.036	16	2488
D30D	0.110	0.029	0.065	0.017	0.085	0.022	0.135	0.036	16	3688
D250E	0.110	0.029	0.060	0.016	0.093	0.025	0.100	0.026	20	1664
D300E	0.110	0.029	0.060	0.016	0.105	0.028	0.100	0.026	20	1664
D350E	0.136	0.036	0.130	0.034	0.193	0.051	0.133	0.035	20	4504
D400E	0.136	0.036	0.130	0.034	0.193	0.051	0.133	0.035	20	4504
Wheel Tractors & Compactors										
814F	0.113	0.030	0.060	0.016	0.051	0.013	0.043	0.011	12	192
815F	0.113	0.030	0.060	0.016	0.051	0.013	0.043	0.011	12	192
816F	0.113	0.030	0.060	0.016	0.051	0.013	0.043	0.011	12	192
824G	0.113	0.030	0.060	0.016	0.073	0.019	0.043	0.011	12	200
825G	0.113	0.030	0.060	0.016	0.096	0.025	0.043	0.011	12	200
826G	0.113	0.030	0.060	0.016	0.096	0.025	0.043	0.011	12	200
834B	0.166	0.044	0.102	0.027	0.102	0.027	0.121	0.032	12	318
836	***	***	***	***	***	***	***	***	***	***
844	0.288	0.075	0.070	0.018	0.218	0.057	0.152	0.040	15	266
854G	0.408	0.108	0.169	0.045	0.353	0.093	0.243	0.054	15	76
Wheel Loaders & Integrated Toolcarriers										
902	***	***	***	***	***	***	***	***	***	***
906	***	***	***	***	***	***	***	***	***	***
914G	0.014	0.004	0.069	0.018	0.013	0.004	—	—	7	600
IT14G	0.014	0.004	0.069	0.018	0.013	0.004	—	—	7	600
924F	0.040	0.010	0.023	0.006	0.020	0.006	0.026	0.007	12	404
IT24F	0.040	0.010	0.023	0.006	0.020	0.006	0.026	0.007	12	584
928G	0.080	0.021	0.034	0.009	0.026	0.007	0.035	0.009	12	444
IT28G	0.080	0.021	0.034	0.009	0.026	0.007	0.035	0.009	12	784
938G	0.081	0.021	0.026	0.008	0.030	0.008	0.023	0.006	13	444
IT38G	0.081	0.021	0.026	0.008	0.030	0.008	0.150	0.006	13	444
950G	0.120	0.032	0.034	0.009	0.030	0.008	0.038	0.010	13	392
962G, IT62G	0.160	0.043	0.034	0.009	0.036	0.010	0.038	0.010	13	392
966F Series II	0.114	0.030	0.045	0.012	0.050	0.014	0.070	0.019	13	432
970F	0.116	0.031	0.046	0.013	0.050	0.014	0.070	0.019	13	432
980G	0.136	0.036	0.058	0.016	0.084	0.022	0.100	0.028	15	714
988F Series II	0.168	0.044	0.070	0.018	0.136	0.035	0.118	0.031	14	198
990 Series II	0.288	0.075	0.070	0.018	0.218	0.057	0.152	0.040	15	266
992G	0.408	0.108	0.169	0.045	0.353	0.093	0.243	0.054	15	76
994	0.800	0.208	0.291	0.076	0.621	0.164	0.450	0.119	17	3694
Telehandlers										
TH62	0.031	0.008	0.012	0.003	0.011	0.003	0.095	0.025	17	1032
TH63	0.031	0.008	0.012	0.003	0.011	0.003	0.095	0.025	17	1032
TH82	0.031	0.008	0.012	0.003	0.011	0.003	0.095	0.025	17	1032
TH83	0.031	0.008	0.012	0.003	0.011	0.003	0.095	0.025	17	1032
Track Loaders										
933C	0.048	0.012	0.014	0.004	0.008	0.002	0.026	0.007	14	720
939C	0.049	0.013	0.015	0.004	0.008	0.002	0.026	0.007	16	720
953C	0.084	0.022	0.033	0.007	0.015	0.004	0.033	0.009	8	832
963B	0.084	0.022	0.036	0.009	0.014	0.004	0.034	0.009	8	828
973	0.110	0.029	0.031	0.008	0.029	0.008	0.030	0.008	8	828

*Total number of lubricant changes (crankcase, transmission, final drives and hydraulic) over a 2000 hour period. Total may vary depending upon the sulfur content of your diesel fuel. Always consult your machine's Lube and Maintenance Guide.

**The number shown here refers to the total number of grease fittings you can expect to service over a 2000 hour period. Total can vary depending upon how your machine is equipped.

***Insufficient data.

†Includes differential (Construction & Mining Trucks/Tractors, Wheel Loaders and Articulated Trucks).

††Includes brakes, converter hoist system and steering system (Construction & Mining Trucks/Tractors).

GUIDE FOR ESTIMATING LOCAL HOURLY COST OF FILTERS

The approximate hourly filter costs at right were determined by using the following formula:

Filters	Change Interval*	#Filters	Cost**	#Filters/2000 hr.	Total Cost
Engine	250 hr.	_____	\$ _____	_____	\$ _____
Transmission	500	_____	_____	_____	_____
Hydraulic	500	_____	_____	_____	_____
Fuel — primary	2000	_____	_____	_____	_____
— final	500	_____	_____	_____	_____
Air — primary	2000	_____	_____	_____	_____
— secondary	1000	_____	_____	_____	_____
Total Filter Cost/2000 hr. = \$ _____					

Total Cost \$ _____ ÷ 2000 hr. = \$ _____ Hourly Filter Cost.

*Recommended change interval may vary with machine and sulfur content of diesel fuel. Always consult Lube & Maintenance Guide.

**Cost of filter is suggested consumer list price. For the small excavators and the 613C, we assumed an average of \$6.50 per filter.

NOTE: The approximate hourly filter costs do *not* include labor. To determine your labor cost you can apply your hourly labor rate to 5 minutes per each filter change. For example, if your labor rate is \$50.00 per hour then your labor cost for one filter change would be \$4.17.

Model	Approx. Hourly Filter Cost	Filters	Model	Approx. Hourly Filter Cost	Filters
Track-Type Tractors			Agricultural Tractors		
D3C Series III	0.08	23	D4E SR	0.09	23
D4C Series III	0.08	23	D6G SR	0.12	27
D5C Series III	0.08	23	Challenger 35	0.42	37
D4E	0.09	23	Challenger 45	0.42	37
D5M	0.25	35	Challenger 55	0.42	37
D5B	0.11	26	Challenger 65E	0.64	36
D6M	0.27	35	Challenger 75E	0.64	36
D6G	0.09	24	Challenger 85E	0.72	36
D6R	0.13	24	Challenger 95E	0.72	36
D7G	0.10	24	Motor Graders		
D7R	0.08	24	120H	0.16	26
D8R	0.35	33	135H	0.16	26
D9R	0.47	51	12H	0.12	22
D10R	0.52	47	140H	0.12	22
D11R	0.62	53	143H	0.19	26
			160H	0.12	22
			163H	0.19	26
			14H	0.12	22
			16H	0.16	22
			24H	0.67	58

Model	Approx. Hourly Filter Cost	Filters	Model	Approx. Hourly Filter Cost	Filters
Backhoe Loaders			Articulated Trucks		
416C	0.16	16	D25D	0.17	32
426C	0.16	16	D30D	0.17	32
428C	0.16	16	D250E	0.15	28
436C	0.16	16	D300E	0.15	28
438C	0.16	16	D350E	0.17	32
446B	0.17	16	D400E	0.25	40
Skidders			Wheel Tractors & Compactors		
515/525	0.21	30	814F	0.13	28
528B	0.10	24	815F, 816F	0.14	28
D4H TSK	0.09	24	824G, 825G		
527	0.10	24	826G	0.18	28
Pipelayers			834B	0.26	36
561M	0.25	35	844	*	*
572G	0.20	27	854G	*	*
578	0.31	33	836	*	*
589	0.39	43	Wheel Loaders & Integrated Toolcarriers		
5000 Series			902	*	*
5130B	0.89	88	906	*	*
5230	1.49	140	914G	0.27	23
Wheel Tractor-Scrapers			IT14G	0.27	23
613C Series II	0.12	28	924F	0.15	24
615C Series II	0.12	24	IT24F	0.15	24
621E	0.21	38	928G	0.24	26
623E	0.21	38	IT28G	0.24	26
627E	0.31	52	938G	0.24	24
631E Series II	0.25	40	IT38G	0.14	24
633E Series II	0.25	40	950G	0.14	34
637E Series II	0.34	59	962G, IT62G	0.14	34
651E	0.27	44	966F Series II	0.18	45
657E	0.52	80	970F	0.18	45
Construction & Mining Trucks & Tractors			980G	0.26	46
769D, 771D	0.31	43	988F Series II	0.39	51
773D, 775D	0.32	47	990 Series II	0.43	56
776D, 777D	0.42	50	992G	0.70	47
784C	0.61	80	994	1.31	94
785C	0.61	80	Track Loaders		
789C	0.76	88	933C	0.08	28
793C	0.72	72	939C	0.08	30
Telehandlers			953C	0.11	24
TH62	0.23	22	963B	0.09	19
TH63	0.23	22	973	0.09	20
TH82	0.23	22			
TH83	0.23	22			
TH103	*	*			

*Insufficient data.

◀Total number of filters changed over a 2000 hour period. Includes engine crankcase, transmission, hydraulic, fuel (primary and final) and air (primary and secondary). Some models include coolant conditioner and air filters. Telehandlers do not include air filters.

GUIDE FOR ESTIMATING LOCAL HOURLY COST OF FILTERS

The approximate hourly filter costs at right were determined by using the following formula:

Filters	Interval*	Change #Filters	Cost**	#Filters/2000 hr.	Total Cost
Engine	250 hr.	_____	\$ _____	_____	\$ _____
Transmission	500	_____	_____	_____	_____
Hydraulic	500	_____	_____	_____	_____
Fuel — primary	2000	_____	_____	_____	_____
— final	500	_____	_____	_____	_____
Air — primary	2000	_____	_____	_____	_____
— secondary	1000	_____	_____	_____	_____
			Total Filter Cost/2000 hr. = \$ _____		

Total Cost \$ _____ ÷ 2000 hr. = \$ _____ Hourly Filter Cost.

*Recommended change interval may vary with machine and sulfur content of diesel fuel. Always consult Lube & Maintenance Guide.
**Cost of filter is suggested consumer list price.

NOTE: The approximate hourly filter costs at right do *not* include labor. To determine your labor cost you can apply your hourly labor rate to 5 minutes per each filter change. For example, if your labor rate is \$50.00 per hour then your labor cost for one filter change would be \$4.17.

Model	Filters◀	Model	Filters◀
301.5	**	M320	20
307	40	320B (3066)	32
307B	26	320 (3116)	26
311B	29	322B	38
312B (3064)	29	325B	38
312B (3054)	27	330B	30
315B	29	345B	38
315B L (3054)	30	350	30
318B L	29	375	51
318B L*	32	5080	51
M312	14	5130B	88
M315	16	5230	140
M318	20		

*France sourced.
**Insufficient data.
◀Total number of filters changed over a 2000 hour period. Includes engine crankcase, transmission, hydraulic, fuel (primary and final) and air (primary and secondary).

TOTAL NUMBER OF FILTERS CHANGED OVER 2000 Hr

Model	307B	311B	312B (3064)	312B (3054)	315B	315B L (3054)	318B L	318B L (3046)	M312	M315	M318	M320	320B (3066)	320 (3116)	322B	325B	330B	345B	350	375	5080	
Filter																						
Engine																						
Fuel	5	5	5	4	5	4	5	5	4	4	8	8	5	8	4	4	4	4	4	8	8	
Oil	9	9	9	5	9	8	9	9	8	8	8	8	9	8	8	8	8	8	8	8	8	
Air Cleaner	1	1	1	4	1	4	1	4	0	0	0	0	4	0	4	4	4	4	4	4	4	
Water Separator	—	—	—	—	—	—	—	—	—	—	—	—	—	—	8	8	—	8	—	—	—	
Hydraulic																						
Return	5	3	3	3	3	3	3	3	1	2	2	2	3	5	3	3	3	3	3	15	15	
Drain	—	5	5	5	5	5	5	5	—	—	—	—	5	—	5	5	5	5	5	10	10	
By-Pass	—	—	—	—	—	—	—	—	—	—	—	—	—	—	—	—	—	—	—	—	—	
Pilot	5	5	5	5	5	5	5	5	1	2	2	2	5	5	5	5	5	5	5	5	5	
Screen	1	1	1	1	1	1	1	1	—	—	—	—	1	—	1	1	1	1	1	1	1	
Total Number Change	26	29	29	27	29	30	29	32	14	16	20	20	32	26	38	38	30	38	30	51	51	

10a TIRES

(Line Item 10a)

Tire costs are an important part of the hourly cost of any wheel machine. The best estimate of this item is obtained when tire life figures based on experience are used with prices the machine owner actually pays for the replacement tires.

For cases in which tire experience is not available, use the following tire life estimator curves.

Tire Life Estimators

- Curves do not allow for additional life from recapping. They assume new tires run to destruction, but this is not necessarily recommended.
- Based on standard machine tires. Optional tires will shift these curves either up or down.
- Sudden failure (blow out) due to exceeding Ton-MPH (tkm/h) limitations is not considered. Nor are premature failures, due to puncture by stumps or sharpened tree limbs (Skidders) or rocks (Trucks, Loaders, etc.).
- Application Zones:

Zone A: almost all tires actually wear through the tread from abrasion.

Zone B: tires wear out normally but others fail prematurely due to rock cuts, impacts and non-repairable punctures.

Zone C: few, if any, tires wear through the tread due to non-repairable damages, usually from rock cuts, impacts and continuous overloading.

NOTE: Tire life can often be increased by using extra tread and extra deep tread tires.

NOTE: Premature failure could occur at any time due to puncture by stumps or sharpened tree limbs.

MOTOR GRADERS

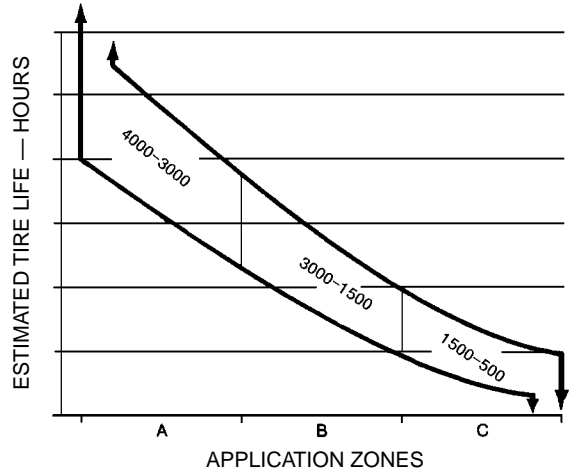

SKIDDERS

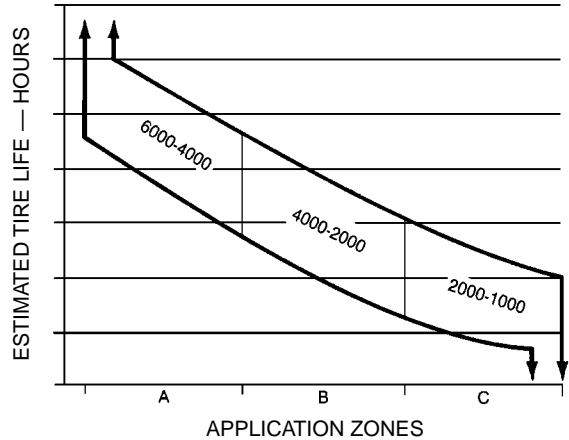

WHEEL TRACTOR-SCRAPERS

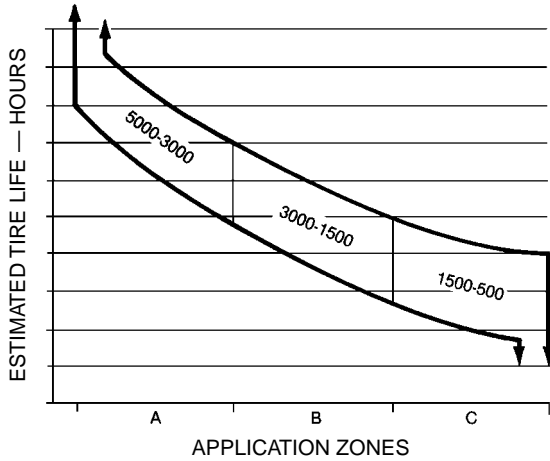

CONSTRUCTION & MINING TRUCKS

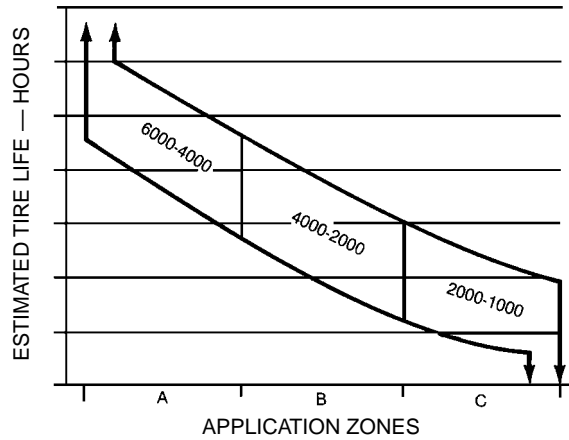

Key:

- Zone A — Almost all tires actually wear through the tread due to abrasion.
- Zone B — Some tires wear out normally while others fail prematurely due to rock cuts, impacts and non-repairable punctures.
- Zone C — Few, if any, tires wear through the tread because of non-repairable damages, usually from rock cuts, impacts or continuous overloading.

ARTICULATED TRUCKS

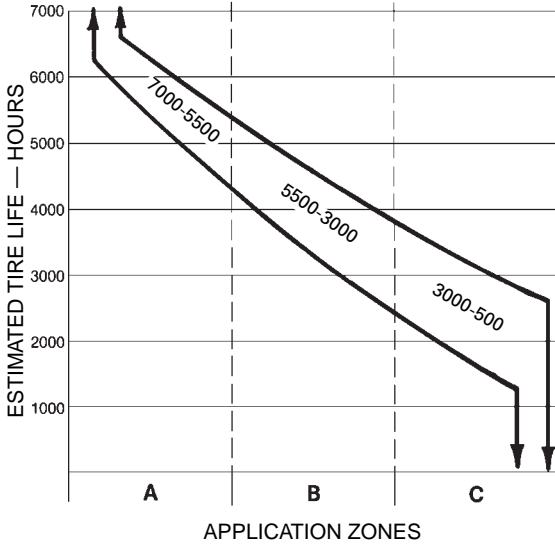

**WHEEL TRACTORS
WHEEL LOADERS**

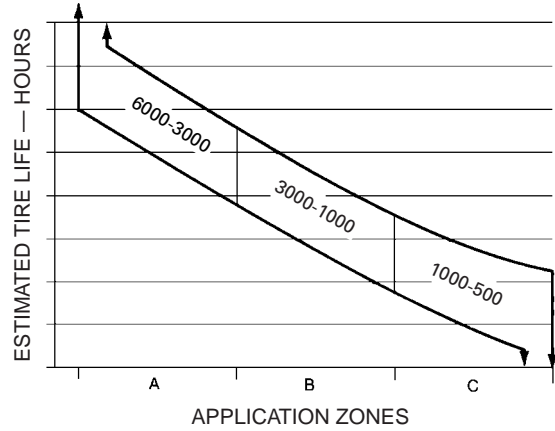

TRACTORS/WAGONS

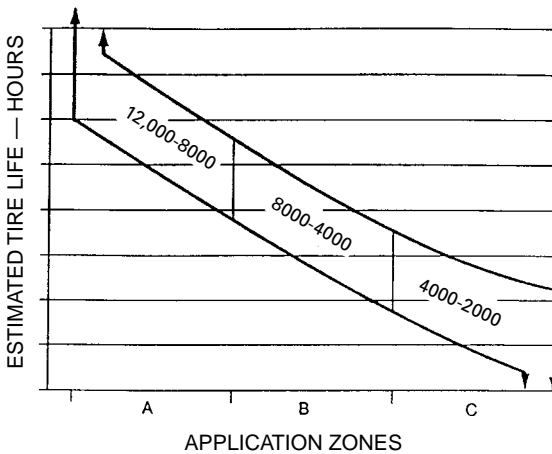

Application Tire Life	Tires Cost Per Hour - Basic Factors		
	Zone A 8000-5000	Zone B 5000-2500	Zone C 2500-500
Model 990 992 994	\$20-\$40	\$30-\$80	\$60-\$400

Key:

- Zone A — Almost all tires actually wear through the tread due to abrasion.
- Zone B — Some tires wear out normally, others fail prematurely due to rock cuts, impacts, and non-repairable punctures.
- Zone C — Few, if any, tires wear through the tread because of non-repairable damages, usually from rock cuts, impacts, or continuous overloading.

GOODYEAR LIFE ESTIMATING SYSTEM

As an additional assist in estimating *hauling unit* tire life, Goodyear Tire and Rubber Co. has furnished the following information which is included here with their permission. READ THE PREAMBLE CAREFULLY.

“... at present, there is no completely accurate, fool-proof method of forecasting tire life. Tire engineers have many theoretical methods ... but these generally are so involved and time consuming that they are impractical for field use.

“However, the tire industry has made many surveys of tire performance and arrived at a system which can give rough *estimates* of tire life. Studies done by the major tire companies and by at least two major equipment manufacturers are in close agreement.

“The table [which follows] shows how to apply this system ...”

ESTIMATED TIRE SERVICE LIFE OF HAULING UNITS (Trucks & Scrapers)

No.	Condition	Factor
I	Maintenance	
	Excellent	1.090
	Average	0.981
	Poor	0.763
II	Speeds (Maximum)	
	10 mph ~ 16 km/h	1.090
	20 mph ~ 32 km/h	0.872
	30 mph ~ 48 km/h	0.763
III	Surface Conditions	
	Soft Earth — No Rock	1.090
	Soft Earth — Some Rock	0.981
	Well Maintained — Gravel Road	0.981
	Poorly Maintained — Gravel Road	0.763
	Blasted — Sharp Rock	0.654
IV	Wheel Positions	
	Trailing	1.090
	Front	0.981
	Driver (Rear Dump)	0.872
	(Bottom Dump)	0.763
	(Self Propelled Scraper)	0.654

No.	Condition	Factor
V	Loads (See No. VIII note)	
	T&RA/ETRTO* Recommended Loading	1.090
	20% Overload	0.872
	40% Overload	0.545
VI	Curves	
	None	1.090
	Medium	0.981
	Severe	0.872
VII	Grades (Drive Tires Only)	
	Level	1.090
	5% Max.	0.981
	15% Max.	0.763
VIII	Other Miscellaneous Combinations (See note below)	
	None	1.090
	Medium	0.981
	Severe	0.872
	Condition VIII is to be used when overloading is present in combination with one or more of the primary conditions of maintenance, speeds, surface conditions and curves. The combination of severe levels in these conditions, together with an overload, will create a new and more serious condition which will contribute to early tire failure to a larger extent than will the individual factors of each condition.	

*Tire and Rim Association/European Tire and Rim Technical Organization.

Type of Tire	Base Average Life		
	Hours	Miles	km
E-3 Std. Bias Tread	2510	25,100	40 400
E-4 Bias Xtra Tread	3510	35,100	56 500
E-4 Radial Xtra Tread	4200	42,000	67 600

Using Base Hours (or Miles), multiply by the appropriate factor for *each* condition to obtain approximate estimated hours (or miles) as the final product.

Example: An off-highway truck equipped with E-4 drive tires running on a well maintained haul road having easy curves and minimum grades and receiving “average” tire maintenance attention but being 20% overloaded:

Condition: I II III IV V VI VII VIII
 Factor: 0.981 × 0.872 × 0.981 × 0.872 × 0.872 × 0.981 × 0.981 × 0.981
 × 3510 base hours = 2114 hours (say 2100 hours)

As can be seen, this system requires the careful application of strictly subjective judgments, and can be expected to result in conservative estimates. Keep in mind, however, **that the system is offered only as an aid in estimating and not as a rigid set of rules.**

On the other hand, if tire life on a given job is considered less than satisfactory, an analysis of these factors may point to conditions which can be improved to the betterment of tire life.

Replacement tire prices should always be obtained from local tire company sources.

Since tires are considered a wear item in this method of estimating owning and operating costs, total tire replacement cost is deducted from machine delivered price to arrive at a net figure for depreciation purposes. Outlay for tires is then included as an item in operating costs:

$$\text{Hourly Tire Cost} = \frac{\text{Replacement Cost of Tires}}{\text{Estimating Tire Life in Hours}}$$

Recapping can sometimes lower hourly tire cost. Considerations are availability of molds, local recapping costs, and experience with recap life.

10b UNDERCARRIAGE

(Line Item 10b)

Undercarriage expense can be a major portion of the operating costs for track-type machines, and these costs can vary *independently* of basic machine costs. That is, the undercarriage can be employed in an extremely abrasive, high-wear environment while the basic machine may be in an essentially easy application, and vice-versa. For that reason, it is recommended that the hourly cost of undercarriage be calculated separately as a wear item rather than being included in the repair reserve for the basic machine. Notice that the repair reserves (Line Item 11) DO NOT include provision for undercarriage replacement.

Three primary conditions affect probable life-expectancy of track-type undercarriage:

- 1. Impact.** The most measurable effect of impact is structural — that is bending, chipping, cracking, spalling, roll-over, etc., and problems with hardware and pin and bushing retention.

Impact ratings:

High — Non-penetrable hard surfaces with 150 mm (6") or higher bumps.

Moderate — Partially penetrable surfaces and bumps of 75-150 mm (3-6") height.

Low — Completely penetrable surfaces (which provide full shoe plate support) with few bumps.

- 2. Abrasiveness.** The tendency of the underfoot materials to grind away the wear surfaces of track components.

Abrasiveness ratings:

High — Saturated wet soils containing a high proportion of hard, angular or sharp sand or rock particles.

Moderate — Slightly or intermittently damp soils containing a low proportion of hard, angular or sharp particles.

Low — Dry soils or rock containing a low proportion of hard, angular or sharp sand or rock chip particles.

Impact and abrasiveness in combination can accelerate wear rates beyond their individual effects when considered alone, thus further reducing component life. This should be taken into account in determining impact and abrasiveness ratings or, if preferred, the combination can be included in selecting the "Z" factor.

- 3. "Z" factor.** Represents the combined effect on component life of the many intangible environmental, operational and maintenance considerations on a given job.

Environment and Terrain. Earth which may not be abrasive itself can pack in sprocket teeth, causing interference and high stress as the teeth engage the bushings. Corrosive chemicals in the materials being moved or in the natural soil can affect wear rates, while moisture and temperature can exaggerate the effect. Temperature alone can play its own role — hot slag and hard-frozen soils being but the extremes. Constant sidehill work can increase wear on the sides of components.

Operation. Some operator practices tend to increase track wear and cost if not controlled on the job. Such practices include high-speed operation, particularly in reverse; tight turns or constant corrections in direction; and stalling the tractor under load forcing the tracks to slip.

Maintenance. Good maintenance — proper track tension, daily cleaning when working in sticky materials, etc. — combined with periodic wear measurement and timely attention to recommended services (CTS) can extend component life and lower costs by minimizing the effects of these and other adverse conditions.

While impact and abrasion should not be too difficult to judge, selection of the proper “Z” factor will require careful analysis of job conditions such as weather, tendency for soil packing, side-hill loading, corrosive environment, etc.; operational factors such as high-speed reverse, tight turns, track slippage under overload, etc.; and maintenance considerations such as proper tensioning, use of Custom Track Service, etc.

Selection of the “Z” multiplier is strictly a matter of judgement and common sense, but its effect on cost can be the difference between profit on a controlled job and heavy loss where control is allowed to slip. To assist in arriving at an appropriate value for the “Z” factor, consider that proper maintenance — or the lack thereof — will represent about 50% of its effect, environment and terrain 30%, and operator practices 20%. Thus, even a good operator working under good field conditions can be counterbalanced by poor maintenance practices to yield a fairly high “Z” factor. On the other hand, close attention to maintenance, tension and alignment can more than offset a bad underfoot condition resulting in severe sprocket packing, and lead to selection of a moderate to low “Z” factor. Obviously, flexibility in selection of a “Z” factor has been built into the system, and use of this flexibility is encouraged. Further, a considerable measure of control can be maintained over the “Z” factor, and any reduction of its effects is money in the bank. Your Caterpillar Dealer CTS man can be invaluable in this endeavor as well as helping you establish a comprehensive undercarriage cost control program.

Estimating Undercarriage Cost

The guide below gives a basic factor for the various track-type machines and a series of conditions multipliers to modify the basic cost according to the anticipated impact, abrasive and miscellaneous (“Z”) conditions under which the unit will be operating.

- Step 1. Select machine and its corresponding basic factor.
- Step 2. Determine range for impact, abrasiveness and “Z” conditions.
- Step 3. Add selected conditions multipliers and apply sum to basic factor.

The result will be the estimated hourly cost for undercarriage in that application.

Undercarriage Basic Factors			
Model	Basic Factor		
5230	19.0		
D11R	17.0		
5130B	15.0		
D10R	12.5		
D9R	10.0		
D8R	8.5		
973, 589, D7R LGP	9.0		
D7R, 963B, 578, D6R LGP, D7R XR	8.0		
375, 5080	6.4		
D6R, 953C, 572, D6M LGP, D6R XL, D6R XR	6.2		
345B, 350	5.3		
D5M LGP, D6 SR, D6M XL, 517, 527	5.0		
330B	4.4		
D3C (All), D4C (All), D5C (All), 933 (All), 939, 561M	3.7		
325B	3.4		
315B, 318B L, 320B, 322B	3.0		
D4 SR	2.5		
307, 307B, 311B, 312B	2.2		
Conditions Multipliers			
	Impact	Abrasiveness	“Z”
High	0.3	0.4	1.0
Moderate	0.2	0.2	0.5
Low	0.1	0.1	0.2

Example: D10R in high impact, non-abrasive material with a moderate “Z” factor.

$$\begin{aligned}
 \text{D10R Basic Factor} &= 12.5 \\
 \text{Multipliers:} \quad I &= 0.3 \\
 \quad \quad \quad A &= 0.1 \\
 \quad \quad \quad Z &= 0.5
 \end{aligned}$$

$$\begin{aligned}
 \text{Hourly undercarriage cost} &= 12.5 (0.3 + 0.1 + 0.5) = \\
 &= \mathbf{\$11.25/hour}
 \end{aligned}$$

- NOTE:** 1. Conditions Multipliers may be selected in any combination. Thus, a multiplier of 0.4 (all low-range multipliers) represents the best of the best, while 1.7 (all high range multipliers) would be the worst of the worst conditions.
2. The hourly undercarriage cost estimate resulting from this method will be made up of *approximately* 70% parts cost and 30% labor charges. The cost of undercarriage components is based on published U.S. Consumers List Prices and may be adjusted as needed for import duties, exchange rates, etc. outside the United States. Labor has been figured at \$40.00 (U.S.) per shop hour.
 3. For further information and guidance, refer to the current issue of the Caterpillar Custom Track Service Handbook.
 4. This formula for estimating undercarriage cost should not be used for tractors working in stockpile coal handling applications. Undercarriage costs are nominal in stockpile coal handling, and using this formula will result in estimating cost substantially above actual costs.

11

REPAIR RESERVE

(Line Item 11)

Repairs are normally the largest single item in operating costs and include all parts and direct labor (except operator's wages) chargeable to the machine. Shop overhead can be absorbed in general overhead or charged to machines as a percent of direct labor cost, whichever is the owner's normal practice.

Hourly repair costs for a single machine normally follow an upward stairstep pattern since major outlays for repairs usually come in spurts. However, when broad averages are considered, the stairstep becomes a smooth, upward curve. Since this hourly repair cost curve starts low and gradually rises over time, hourly operating costs must be adjusted upward as the unit ages. Alternatively an average repair cost can be used which provides a straight line graph. Most owners prefer the average method, and it is the one suggested here.

Since repair costs are low initially and rise gradually, averaging them produces extra funds at first which are reserved to cover future higher costs.

Machine applications, operating conditions and maintenance attention determine repair costs. In any specific application, actual cost experience on similar work provides the best basis for establishing the hourly repair reserve. When local records are inadequate or not available, the hourly repair reserve charts following this discussion may be used. Turn for a moment to these charts and examine their general format.

These average costs are taken from a variety of applications and every attempt was made to assure accuracy. Recognize that any one application may vary considerably from these averages. They are only marginally useful in predicting costs since few jobs are 'average'. The use of these averages would be especially questioned when special attachments such as rippers are used, and when a machine is moving from job to job. For these reasons, we suggest the use of these averages for comparative purposes and gross estimates only. Your Caterpillar dealer has the ability to make more accurate repair cost estimates and we suggest you use his experience and expertise if you need help in estimating operating costs.

Applying these basic factors and multipliers will result in the average hourly cost over the entire period. This should produce an excess in the early hours (or a "sinking fund") to cover normal increases in actual repair costs as the machine ages.

The cost applies to the machine as described in each individual chart, but does not cover the following:

- Dozer blade (although hydraulics are included)
- Bucket (although hydraulics are included)
- Ground engaging tools
- Undercarriage
- Tires, Chopper Blades or Tamping Feet Assemblies and Rims

- Labor for daily and periodic maintenance
- Material/supply items for daily and periodic maintenance
- Fuel, oil and grease
- Service truck mileage costs
- Serviceman's travel costs
- Machine transportation to and from shop
- Cost of performing Technical Analysis or Scheduled Oil Sampling
- Operator
- Risk or insurance
- Parts and labor price escalation
- Attachments

The basic repair factors are based on the first 10,000 hours of service, parts at published U.S. Consumers List Prices, and labor at a total selling price of \$40.00 (U.S.) per hour. Extended use multipliers are given for those cases where a machine is to be used beyond 10,000 hours; the adjusted cost-per hour will apply to the *entire* use period, not just the additional hours. For applications outside the United States where import duties and other expenses have a large effect on parts prices, and for other areas where labor charges (remember to include shop and tool overhead in addition to mechanic's wages!) differ greatly from the \$40.00 base, an approximate breakdown of the total factor by percentages for parts and labor also are given. This breakdown should permit easy adjustment to local conditions.

As stated, repair costs are affected by application, operation, maintenance, and age of the equipment. The most significant effects on cost will be those factors affecting major component life. A second significant factor is whether the repair is performed before or after catastrophic failure. Repair before a major component fails can be one-third of an after failure repair with only a moderate sacrifice in life (see graphs). Repairing a major component just prior to failure achieves optimum cost per hour. Oil analysis and other diagnostic tools, maintenance inspections and indicators, and operator notes are vital to determine the optimum repair point and thereby achieving lower hourly repair costs. Maintenance practices are significant because they affect component longevity and the percentage of scheduled, before failure repairs.

Another important factor in using repair reserve estimates is the Service Meter Unit (SMU) or hour basis. The cost estimate should be flexed depending on the machine's duty cycle. Fuel consumption is often a good indicator of duty cycle, and this factor may override the application zone. All of these factors are significant in estimating repair costs. Weigh them carefully prior to using the repair reserve tables.

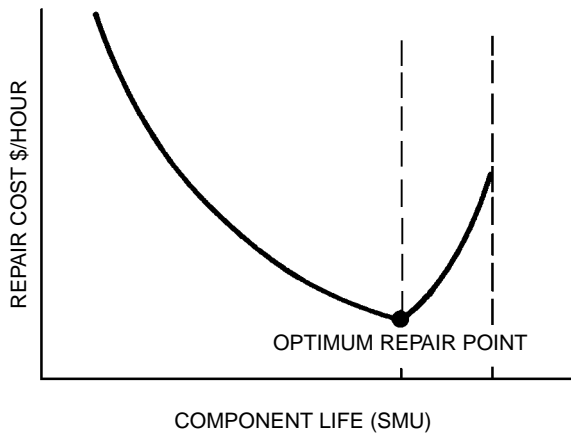
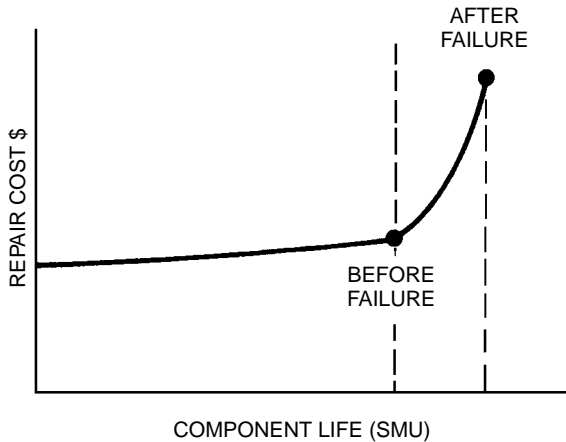

INSTRUCTIONS — To estimate hourly repair costs, enter the chart for the machine in question and determine the basic factor for the applicable job conditions. Operating conditions zones for each bar are:



These generally conform to the definitions given earlier in the section on depreciation. If the unit is to be used more than 10,000 hours, apply the Extended-life Multiplier for that period.

Example:

- 1 — A 988F Wheel Loader loading well-shot rock on a hard, level quarry floor will be used for seven years or about 15,000 hours.

Basic Repair Factor = 9.50
 Extended-life Multiplier = 1.10
 Estimated Repair Cost = 9.50 × 1.10 =
\$10.45/Hour

- 2 — A D6H is used about 1600 hours per year on general utility and clean-up work for a contractor who does not baby his equipment, but does insist on careful operation, and has an excellent preventive maintenance program. He intends to trade at the end of five years. He can be considered to be at the lower end of the “normal” or B zone, if not slightly less.

Basic Repair Factor = 4.50
 Total Use:
 5 years @ 1600 hr/yr = **8000** hours
 Extended-use Multiplier = 1.0
 Estimated Repair Cost = 4.50 × 1.0 =
\$4.50/Hour

Repair Reserve charts follow ...▶

TRACK-TYPE TRACTORS

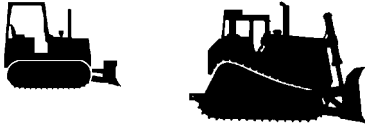

Cost distribution

D3 to D7 — 60% Parts
40% Labor
D8 to D11 — 70% Parts
30% Labor

Extended-life Multipliers

0-10,000 hours 1.0
0-15,000 1.1
0-20,000 1.3

Includes basic tractor equipped with ROPS canopy, straight bulldozer and hydraulic control.

NOTE: Repair time may be less on Elevated Sprocket Tractors due to modular design of power train components.

**AGRICULTURAL TRACTORS
(basic configuration)**



Cost distribution
60% Parts
40% Labor

MOTOR GRADERS



Cost distribution

120H Thru 135H
65% Parts
35% Labor

12H Thru 16H

65% Parts
35% Labor

24H

60% Parts
40% Labor

Extended-life Multipliers

0-10,000 hours 1.00
0-15,000 1.00
0-20,000 1.33

0-10,000 hours 1.00
0-15,000 1.20
0-20,000 1.55

0-15,000 hours 0.78
0-20,000 1.00
0-30,000 1.05
0-40,000 1.20

Includes basic motor grader equipped with ROPS cab.

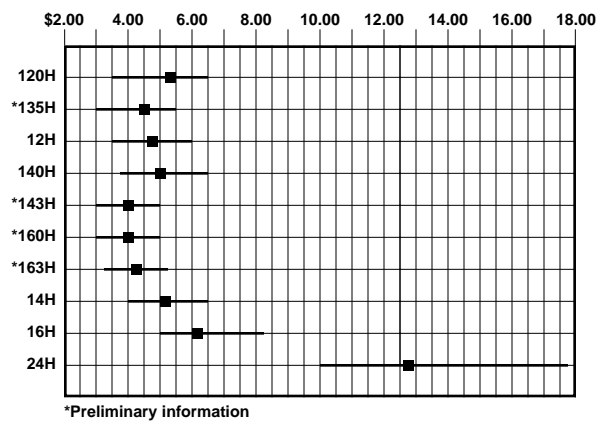
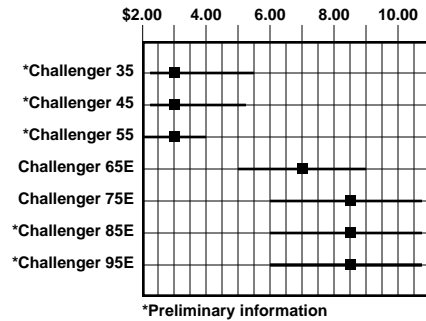
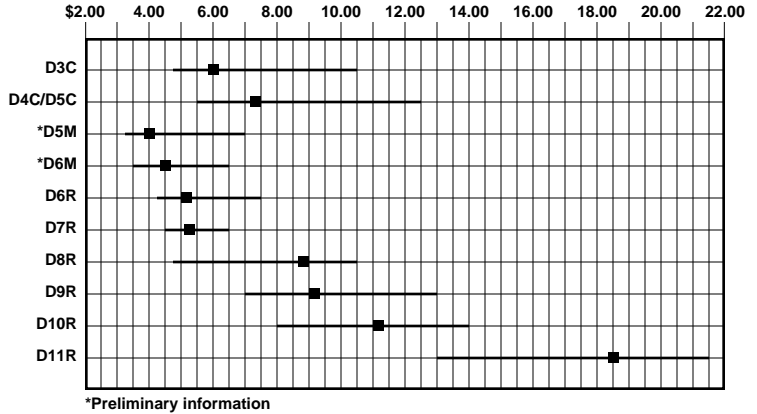

EXCAVATORS



Cost distribution

50% Parts
50% Labor

Extended-life Multipliers

(Not available)

5130 & 5230

Cost distribution

70% Parts
30% Labor

Extended-life Multipliers

0-10,000 hours	0.40
0-20,000	0.80
0-30,000	1.00
0-40,000	1.21
0-60,000	1.25

Includes basic excavator equipped with largest bucket, one-piece boom and medium stick. Logger with standard feller buncher.

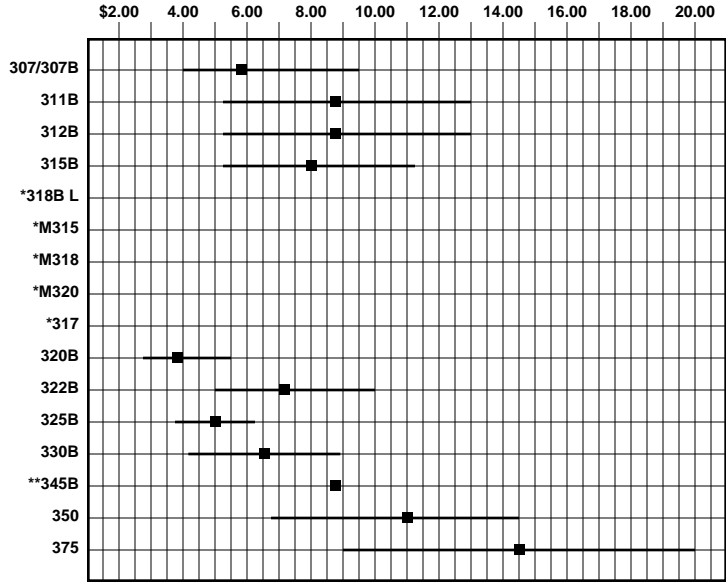

*Insufficient data

**Preliminary information

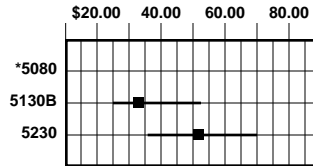

*Insufficient data

SKIDDERS



Cost distribution

55% Parts
45% Labor

Extended-life Multipliers

(Not available)

Includes basic skidder equipped with ROPS canopy, arch, fairlead and winch. 518 Grapple skidders with Cat grapple, 530B Grapple skidder with AEM grapple.

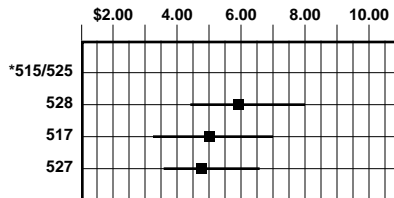

*Insufficient data

PIPELAYERS

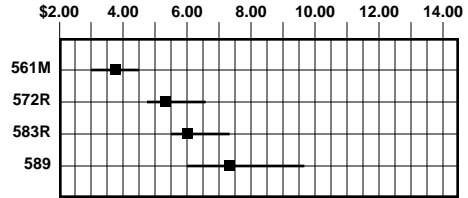
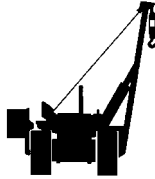

Cost distribution

60% Parts
40% Labor

Extended-life Multipliers

(Not available)

Includes basic pipelayer equipped with counterweight and boom.

WHEEL-TRACTOR SCRAPERS

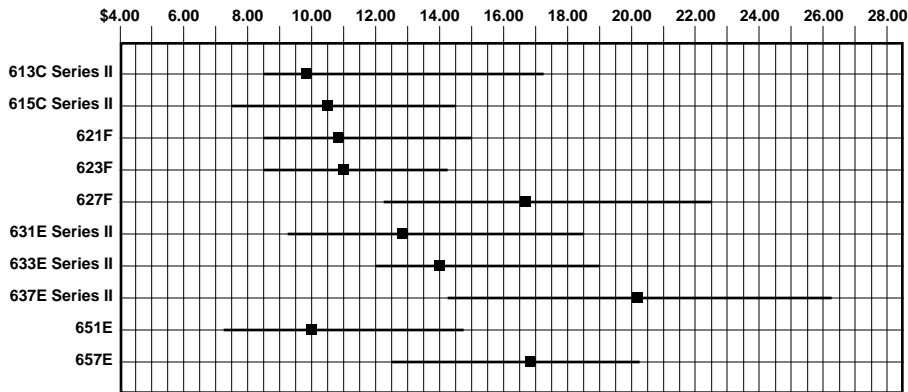

Cost distribution:

55% Parts
45% Labor

Extended-life Multipliers:

Period	Single-engine	Tandem & Elevator
0-10,000	1.00	1.00 (1.03 for Push-Pull)
1-15,000	1.06	1.08
0-20,000	1.21	1.24

Includes standard wheel tractor equipped with standard scraper.

CONSTRUCTION & MINING TRUCKS

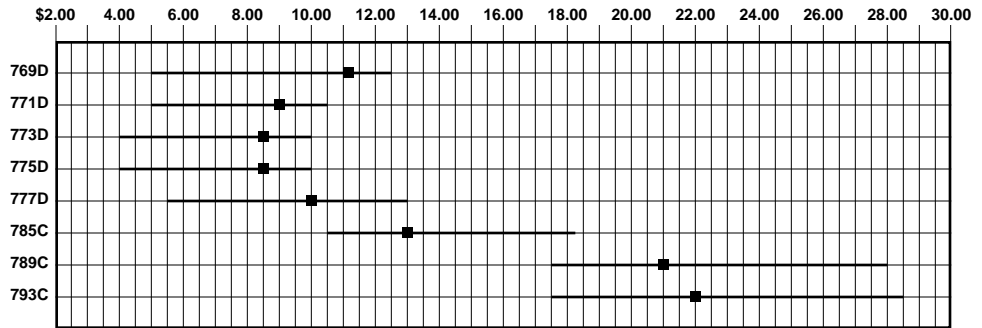

Cost distribution

769-777

- 55% Parts
- 45% Labor

785-793

- 70% Parts
- 30% Labor

Extended-life Multipliers

0-10,000 hours	0.20
0-20,000	1.00
0-30,000	1.18
0-40,000	1.50
0-60,000	1.50

Includes basic truck equipped with standard earth body (785/789 — Option I Body) without liners. Off-highway tractors' hourly repair costs are approximately 9% less than trucks.

ARTICULATED TRUCKS

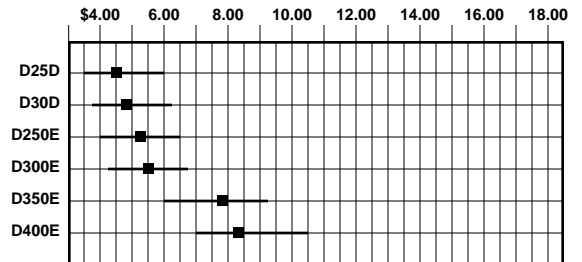

Cost distribution

- 55% Parts
- 45% Labor

Extended-life Multipliers

0-10,000 hours	1.00
0-15,000	1.05
0-20,000	Not Available

WHEEL TRACTORS & SOIL/LANDFILL COMPACTORS



Cost distribution

60% Parts
40% Labor

Extended-life Multipliers

(Not available)

Includes: 814F, 824G & 834B — Basic tractor equipped with ROPS canopy and bulldozer.
815F & 825G — Basic compactor equipped with ROPS canopy and fill-spreading bulldozer.
816F & 826G — Basic Landfill Compactor equipped with ROPS cab and landfill bulldozer.

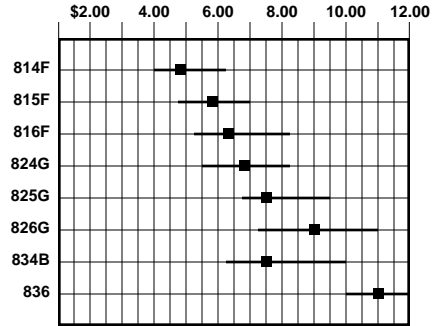

WHEEL LOADERS & INTEGRATED TOOLCARRIERS



Cost distribution
914-992

60% Parts
40% Labor

Extended-life Multipliers

0-10,000 hours	1.00
0-15,000	1.10

994

75% Parts	0-10,000	0.25
25% Labor	0-20,000	0.54
	0-30,000	1.00
	0-40,000	1.07
	0-60,000	1.25

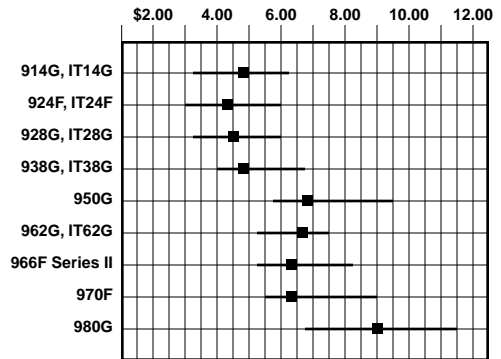

Includes basic wheel loader equipped with ROPS cab and General Purpose bucket (988 and 992 with Spade nose rock bucket).

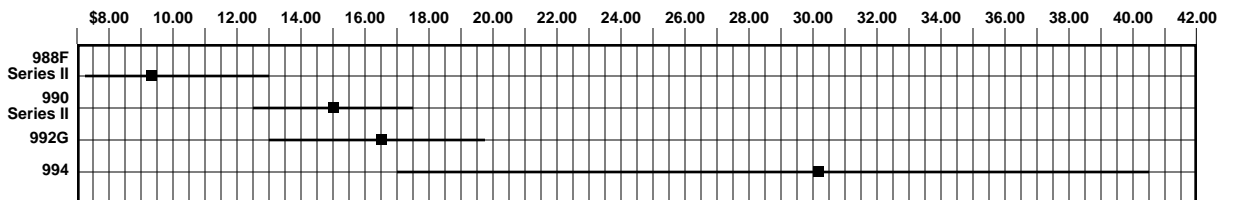

TRACK LOADERS



Cost distribution

55% Parts
45% Labor

Extended-life Multipliers

0-10,000 hours 1.00
0-15,000 1.13

Includes basic track loader equipped with ROPS canopy and General Purpose bucket.

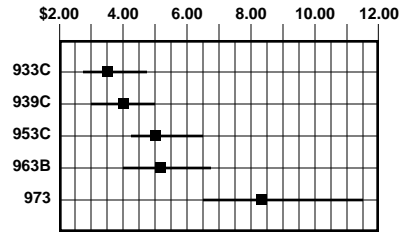

Owning & Operating Costs

- ⑫ Special Wear Items
 - ⑮ Operator's Wage
- ### Owning & Operating Examples
- Track-Type Tractor

12

SPECIAL WEAR ITEMS

(Line Item 12 and Subsection 12A)

All costs for high-wear items such as cutting edges, ripper tips, bucket teeth, body liners, router bits, etc., and welding costs on booms and sticks should be included here. These costs will vary widely depending on applications, materials and operating techniques. Consult your Caterpillar Dealer Parts Department for estimated life under your job conditions.

15

OPERATOR'S HOURLY WAGE

(Line Item 15)

This item should be based on local wage scales and should include the hourly cost of fringe benefits.

EXAMPLES OF FIGURING OWNING AND OPERATING COSTS

Example I: ESTIMATING HOURLY OWNING AND OPERATING COSTS OF A TRACK-TYPE TRACTOR

Assume a power shift track-type tractor with straight bulldozer, hydraulic control, tilt cylinder and three-shank ripper, is purchased by a contractor for \$135,000, delivered price at job site.

Application will be production dozing of bank gravel. Minimal ripping will be required to loosen material.

In the following calculations, refer as necessary to the source material already reviewed.

OWNING COSTS —

To Determine Residual Value at Replacement

Enter delivered price, \$135,000, in space (A). (See example form at end of this discussion.) Since the machine being considered is a track-type tractor, no tires are involved. This particular owner's experience is that at trade-in time, the tractor will be worth approximately 35% of its original value. This \$47,250 trade-in value is entered in space (B) leaving a net of \$87,750 to be recovered through work.

Enter the value to be recovered through work in space (C).

Indicated ownership period is 7 years with annual usage of 1200 hours per year or 8400 hours of total ownership usage.

Divide the Net Value from space (C), \$87,750, by Ownership Usage, 8400 hours, and enter result \$10.45 in space (D).

Interest, Insurance, Taxes

In this example, local rates are assumed as follows:

Interest	16%
Insurance	1%
Taxes	1%
	<hr/>
	18%

Using the following formula:

$N = 7$:

$$\frac{\left[\frac{7 + 1}{2 \times 7} \times \$135,000 \right] \times 0.16}{1,200} = \$10.29$$

Enter \$10.29 in space (E).

Insurance and property taxes can also be calculated using the same formula as shown for the interest cost, and entering them on lines 5 and 6.

Items 3b, 4, 5 and 6 can now be added and the result, \$22.02 entered in space (H) Total Hourly Owning Costs.

OPERATING COSTS —

Fuel

See fuel consumption tables. The intended application, production dozing, indicates a medium load factor. Assume that the estimated fuel consumption from the table is 18.1 liter/hr (4.8 U.S. gal/hr.). Cost of fuel in this locality is \$0.34/liter (\$1.25/U.S. gal.).

Consumption	Unit Cost	Total
18 liter/hr	× \$0.34 liter	= \$6.12
5 gal/hr	× \$1.25 gal.	= \$6.25

Enter this figure in space (I).

Lube Oils, Filters, Grease

For these items, you can use the lubricants consumption tables and the filter cost calculator for a detailed estimate, or you can obtain an estimate of the total of these items from the Quick Estimator table. We will assume local prices in this example are about the same as those used for the Quick Estimate Table and use this method. Assume the table shows an approximate hourly cost for lube oils, filters and grease (materials and labor) for this tractor of \$0.46. Enter this figure in space (J).

Tires

Since this example considers a track-type tractor, space (K) is left blank.

Undercarriage

Our estimating reference gives an undercarriage cost Basic Factor of 6.2 for this tractor. It is anticipated that with some ripping on the job, impact loadings of the track components will be medium, indicating an “I” multiplier of 0.2. The gravel-sand mix in the bank, being dry, should be only moderately abrasive for an “A” multiplier of 0.2. In analyzing the miscellaneous conditions: there is enough clay in the bank to produce some packing of the sprockets; the operator is careful, but is forced into some tight turns because of space limitations; there is good drainage in the pit; track tension is checked weekly; and all track-type equipment on the job is enrolled in the Custom Track Service program. Accordingly, the “Z” multiplier is judged to be somewhat greater than low level — 0.3 in this case.

It should be noted that in applying particularly the “Z” factor, rather wide latitude for flexibility is provided and was used in the above example. Such flexibility is intended and its use encouraged.

Then:

$$\text{Cost per hour} = \text{Basic Factor} \times (\text{I} + \text{A} + \text{Z})$$

$$\text{Basic Factor} = 6.2$$

$$\text{Conditions Multipliers: I} = 0.2$$

$$\text{A} = 0.2$$

$$\text{Z} = 0.3$$

$$\text{Cost per hour } 6.2 (0.2 + 0.2 + 0.3) = \$4.34 \text{ which is entered in space (L).}$$

Repairs

In determining the depreciation period, we established the intended use of the machine as a Zone B application. The Repair Reserve graph for track-type

tractors indicates that the mid-range for our tractor is approximately 4.50 on the basis of 10,000 hours of use. The tractor is to be used over 8400 hours, so the Extended-life Multiplier in this case is 1.0.

Therefore, Repair Reserve = $1.0 \times 4.50 = \$4.50$ per hour, which is entered in space (M).

Special Items

Assuming the tractor is equipped with a three-shank ripper and an “S” dozer, allowance must be made for ripper tips, shank protectors, and dozer cutting edges.

Assume your knowledge of the operation indicates the ripper will be used only about 20% of total tractor operating time. Estimated tip life while in use is 30 hours. Therefore, tips will be replaced:

$$\frac{30 \text{ Hours}}{0.20} = \text{each 150 hours of tractor operation}$$

Shank protector life is estimated at three times tip life or 450 hours of tractor operation. In this medium duty application, no shank replacement is expected in the 8400 hour depreciation period of the tractor.

Cutting edge life is estimated to be 500 hours.

Using local prices for these items, hourly costs are estimated as follows:

$$\text{Tips: } \frac{3 @ \$35.00 \text{ ea.}}{150 \text{ hr.}} = \$0.70 \text{ per hour}$$

$$\text{Shank Protectors: } \frac{3 @ \$55.00 \text{ ea.}}{450 \text{ hr.}} = \$0.37 \text{ per hour}$$

$$\text{Cutting Edges: } \frac{\$125 \text{ per set}}{500 \text{ hr.}} = \$0.25 \text{ per hour}$$

The total of these, \$1.32; is entered in space (N).

Items 8, 9, 10b, 11 and 12 can now be added and the result, \$15.63, is entered in space (O), Total Hourly Operating Costs.

Operator's Hourly Wage

Assume this is \$20.00 including fringe benefits. This figure is entered in space (P).

Total Owing Costs, Total Operating Costs and Operator's Hourly Wage are now added together and the result, \$57.65, is entered in space (Q). The itemized estimate of Hourly Owing and Operating Costs is now complete.

Example II: ESTIMATING HOURLY OWNING AND OPERATING COSTS OF A WHEELED VEHICLE

With only a few simple changes, owning and operating costs for a wheeled vehicle are calculated using the same format as that used for the Track-Type Tractor. Only the differences will be explained as we look at example calculations for a wheel loader.

OWNING COSTS —

To Determine Residual Value at Replacement

Enter delivered price in space (A). The cost of tires is deducted since they will be treated as a wear item. For purposes of illustration, the Wheel Loader is estimated to have a potential 48% trade-in value (B) at the end of the 5 year/7500 hour ownership usage, leaving a net value to be recovered through work of \$34,320 (C).

Interest, Insurance, Taxes

Refer to the formulas using the same rates as before and 1500 operating hours per year. The factor 4.22 is applied to the interest cost (E).

Insurance and property taxes can also be calculated using the same formula as shown for the interest cost.

The sum of lines 3b, 4, 5 and 6 gives the total hourly owning cost, line 7.

OPERATING COSTS —

Fuel

See the fuel consumption tables and apply the actual cost of purchasing fuel in the project area (I).

Lube Oils, Filters, Etc.

Use either the item-by-item worksheet or the summary tables. Enter the total item in space (J) on line 9.

Tires

Use the tire replacement cost and the best estimate of tire life based on experience and anticipated job conditions.

Repairs

Find the applicable basic repair factor for Zone B application from the bar charts (4.00). Again, the use period for the Wheel Loader is 7500 hours, so the Extended-life Multiplier is 1.0.

Therefore, Repair Reserve = $1.0 \times 4.00 = \$4.00$ per hour.

Special Items

Ground engaging tools, welding, etc. are covered here. Use current costs for cutting edges and similar items. Use your best estimate of the hours of life which can be expected from them based on previous experience in like materials. Enter the total on line 12.

The total of lines 8 through 13 represents hourly operating costs.

Operator's Wages

To give a true picture of operator cost, include fringe benefits as well as direct hourly wages (line 15).

TOTAL O&O

The total of lines 7, 13 and 15 is the total hourly owning and operating cost of the machine. Keep in mind that this is an estimate and can change radically from project to project. For the greatest accuracy, the hourly cost reflected in actual on-the-job cost records should be used.



HOURLY OWNING AND OPERATING COST ESTIMATE

DATE _____

	(1)	(2)
	Track-type Tractor	Wheel Loader
Machine Designation		
Estimated Ownership Period (Years)	<u>7</u>	<u>5</u>
Estimated Usage (Hours/Year)	<u>1200</u>	<u>1500</u>
Ownership Usage (Total Hours)	<u>8400</u>	<u>7500</u>

OWNING COSTS

	(1)	(2)
1. a. Delivered Price (including attachments)	<u>135,000 (A)</u>	<u>70,000</u>
b. Less Tire Replacement Cost if desired		<u>4000</u>
c. Delivered Price Less Tires	<u>135,000</u>	<u>66,000</u>
2. Less Residual Value at Replacement	(35 %) <u>47,250 (B)</u>	(48 %) <u>31,680</u>
(See subsection 2A on back)		
3. a. Value to be recovered through work	<u>87,750 (C)</u>	<u>34,320</u>
(line 1c less line 2)		
b. Cost Per Hour:		
Value (1) <u>87,750</u> (2) <u>34,320</u>	<u>10.45 (D)</u>	<u>4.58</u>
Hours 8400 7500		
4. Interest Costs $\frac{N + 1}{2N} \times \text{Del. Price} \times \frac{\text{Simple Int.}}{\% \text{ Rate}}$ =		
N = No. Yrs. Hours/Year		
(1) $\frac{7 + 1}{14} \times \frac{135,000}{1200 \text{ Hours/Yr.}} \times 16 \%$ (2) $\frac{5 + 1}{10} \times \frac{66,000}{1500 \text{ Hours/Yr.}} \times 16 \%$	<u>10.29 (E)</u>	<u>4.22</u>
_____ = _____ =		
5. Insurance $\frac{N + 1}{2N} \times \text{Del. Price} \times \frac{\text{Insurance}}{\% \text{ Rate}}$ =		
N = No. Yrs. Hours/Year		
(1) $\frac{7 + 1}{14} \times \frac{135,000}{1200 \text{ Hours/Yr.}} \times 1 \%$ (2) $\frac{5 + 1}{10} \times \frac{66,000}{1500 \text{ Hours/Yr.}} \times 1 \%$	<u>0.64 (F)</u>	<u>0.26</u>
_____ = _____ =		

Or

\$ _____ Per Yr. ÷ _____ Hours/Yr. =

Estimating form continues next page

	(1)	(2)
6. Property Tax $N = \text{No. Yrs.} \quad \frac{N + 1}{2N} \times \text{Del. Price} \times \text{Tax Rate \%} =$ $\frac{\text{Hours/Year}}{\text{Hours/Year}} =$ (1) $\frac{7 + 1}{14} \times \frac{135,000}{1200} \times \frac{1}{100} =$ (2) $\frac{5 + 1}{10} \times \frac{66,000}{1500} \times \frac{1}{100} =$	0.64 (G)	0.26
Or \$ _____ Per Yr. ÷ _____ Hours/Yr. =		
7. TOTAL HOURLY OWNING COST (add lines 3b, 4, 5, and 6)	22.02 (H)	9.32
OPERATING COSTS		
8. Fuel: (1) $\frac{\text{Unit Price}}{1.25} \times \frac{\text{Consumption}}{5} =$ (2) $\frac{1.25}{1.25} \times \frac{4}{4} =$	6.25 (I)	5.00
9. Lube Oils, Filters, Grease: (See subsection 9A on back)	0.46 (J)	0.43
10. a. Tires: Replacement Cost ÷ Life in Hours $\frac{\text{Cost}}{\text{Life}} \quad (1) \frac{\quad}{\quad} \quad (2) \frac{4000}{3500} \dots\dots\dots$	(K)	1.14
b. Undercarriage (Impact + Abrasiveness + Z Factor) × Basic Factor (1) $(0.2 + 0.2 + 0.3) = 0.7 \times 6.2 =$ (2) $(\quad + \quad + \quad) = \frac{\quad}{(\text{Total})} \times \frac{\quad}{(\text{Factor})} =$	4.34 (L)	_____
11. Repair Reserve (Extended Use Multiplier × Basic Repair Factor) (1) $1.0 \times 4.5 =$ (2) $1.0 \times 4.00 =$	4.50 (M)	4.00
12. Special Wear Items: Cost ÷ Life	1.32 (N)	0.60
(See subsection 12A on back)		
13. TOTAL OPERATING COSTS (add lines 8, 9, 10a (or 10b), 11 and 12)	16.87 (O)	11.17
14. MACHINE OWNING PLUS OPERATING (add lines 7 and 13)	38.89	20.49
15. OPERATOR'S HOURLY WAGE (include fringes)	20.00 (P)	20.00
16. TOTAL OWNING AND OPERATING COST	58.89 (Q)	40.49

SUBSECTION 2A: Residual Value at Replacement

Gross Selling Price	(1) (___%) _____	(2) (___%) _____
Less: a. Commission	_____	_____
b. Make-ready costs	_____	_____
c. Inflation during ownership period*	_____	_____
Net Residual Value (Enter on line 2)	47,250 (35%)	31,680 (48%) of original delivered price

*When used equipment auction prices are used to estimate residual value, the effect of inflation during the ownership period should be removed to show in constant value what part of the asset must be recovered through work.

SUBSECTION 9A: Lube Oils, Filters, Grease

	Unit Price	×	Consumption =	Cost/Hour				
Engine	(1) _____	×	_____ =	_____	(2) _____	×	_____ =	_____
Transmission	_____	×	_____ =	_____	_____	×	_____ =	_____
Final Drives	_____	×	_____ =	_____	_____	×	_____ =	_____
Hydraulics	_____	×	_____ =	_____	_____	×	_____ =	_____
Grease	_____	×	_____ =	_____	_____	×	_____ =	_____
Filters	_____	×	_____ =	_____	_____	×	_____ =	_____
			Total (1) _____		(2) _____			

(Enter total on line 9 or use Quick Estimator Tables)

SUBSECTION 12A: Special Items

(cutting edges, ground engaging tools, bucket teeth, excavator stick repair, etc.)

(1)	Cost	Life	Cost/Hour	(2)
1.	105 ÷	150 =	0.70	1. _____ ÷ _____ = _____
2.	165 ÷	450 =	0.37	2. _____ ÷ _____ = _____
3.	125 ÷	500 =	0.25	3. _____ ÷ _____ = _____
4.	_____ ÷	_____ =	_____	4. _____ ÷ _____ = _____
5.	_____ ÷	_____ =	_____	5. _____ ÷ _____ = _____
6.	_____ ÷	_____ =	_____	6. _____ ÷ _____ = _____
		Total (1)	\$1.32	(2) _____

(Enter total on line 12)

REPAIR RESERVE CONVERSION FACTORS (line 11)

For use in countries outside the United States where parts and service costs might differ from those used in charts and tables:

Labor Rate Ratio (1)	_____	(2)	_____
Parts Cost Ratio (1)	_____	(2)	_____

QUICK ESTIMATOR HOURLY OWNING AND OPERATING COSTS

NOTE: Hourly Owning and Operating Costs for a given model of machinery vary widely because they are influenced by many factors: the type of work the machine does, local prices for fuel and lubricants, shipping costs from the factory, interest rates, operator’s wages, tire or track life, rock versus earth, hours per year, etc. Use the following figures as **QUICK GUIDELINES ONLY**. When precise owning & operating cost estimates are required, calculate them using the format on the preceding pages and your particular conditions.

Quick estimator figures shown are based on the following assumptions:

- List prices f.o.b. factory.
- Machines equipped as indicated (certain attachments included may not be normal in some areas).
- Ownership period: Guide for selecting ownership period based on application and operating conditions.
- The basic repair factors are based on the first 10,000 hours of service.
- Parts at published U.S. Consumers List Prices.
- Labor for repairs at a total selling price of \$50.00 (U.S.) per hour.
- **MODERATE:** Zone A, or moderate job conditions. Typical U.S.A. Auction Results for the machine used in computing resale and depreciation.
- **AVERAGE:** Zone B, or average job conditions. Typical U.S.A. Auction Results for the machine used in computing resale and depreciation.
- **SEVERE:** Zone C, or severe job conditions. Typical U.S.A. Auction Results for the machine used in computing resale and depreciation and is adjusted for machine condition.
- Lubricants and hydraulic oil at \$6.35 per U.S. Gal. plus labor.
- Grease at \$0.71 per fitting (includes labor).
- Filters at U.S. Consumer’s List Prices plus labor.
- Fuel at \$1.25 per U.S. Gal.
- Figures include average tire costs at 50% list price.
- **ALL FIGURES EXCLUDE INTEREST, INSURANCE, TAXES AND OPERATOR (due to wide variance around the world).**

Track-Type Tractors *Example equipment:* straight bulldozer with tilt cylinder, hydraulic control, ROPS canopy, crankcase and track roller guards, front pull hook, light system, and vandalism protection.

	O&O/hr.		
	Moderate	Average	Severe
D3C Series III	\$ 9.00	\$ 14.00	\$ 22.00
D4C Series III	11.00	16.00	25.00
D5C Series III	12.00	16.00	25.00
D5M	20.00	25.00	30.00
D5B	18.00	21.00	35.00
D6M	25.00	31.00	37.00
D6G	23.00	30.00	50.00
D6R	27.00	35.00	43.00
D7G	32.00	41.00	63.00
D7R	36.00	46.00	56.00
D8R	46.00	61.00	73.00
D9R	69.00	86.00	107.00
D10R	86.00	104.00	131.00
D11R	120.00	135.00	165.00

Agricultural Tractors *Example equipment:* programmable monitor, 544 kg (1200 lb) front counterweight, additional light group, 132 Lpm (35 gpm) implement pump and high torque steering motor.

D4E SR	\$15.00	\$20.00	\$30.00
D6G SR	22.00	29.00	45.00
Challenger 35	15.00	20.00	30.00
Challenger 45	18.00	23.00	33.00
Challenger 55	20.00	25.00	35.00
Challenger 65E	21.00	26.00	36.00
Challenger 75E	22.00	28.00	38.00
Challenger 85E	22.00	30.00	39.00
Challenger 95E	23.00	31.00	40.00

Motor Graders *Example equipment:* hydraulic side-shift with tip, ROPS cab, heater, front lights, vandalism protection.

	O&O/hr.		
	Moderate	Average	Severe
120H	\$17.00	\$22.00	\$28.00
135H	18.00	23.00	29.00
12H	21.00	25.00	31.00
140H	22.00	26.00	33.00
143H	23.00	29.00	37.00
160H	23.00	29.00	37.00
163H	24.00	32.00	40.00
14H	27.00	35.00	46.00
16H	37.00	48.00	64.00
24H	55.00	71.00	87.00

Excavators, Feller Bunchers and Front Shovels

Example equipment: largest undercarriage (or standard tires), largest bucket or standard feller buncher, medium stick, one-piece boom.

	O&O/hr.		
	Moderate	Average	Severe
301.5	*	*	*
307B/307B SB	*	*	*
311B	*	*	*
312B	*	*	*
315B	*	*	*
318B L/318B LN	*	*	*
320B	\$19.00	\$22.00	\$34.00
322B	19.00	25.00	38.00
325B	19.00	29.00	46.00
330B	27.00	32.00	51.00
345B	*	*	*
350	39.00	50.00	79.00
375	62.00	80.00	124.00
5080	65.00	83.00	130.00
5130B	*	*	*
5230	*	*	*

*Insufficient data.

Backhoe Loaders

	O&O/hr.		
	Moderate	Average	Severe
416C	\$14.00	\$16.00	\$20.00
426C	15.00	19.00	22.00
428C	15.00	19.00	22.00
436C	16.00	20.00	24.00
438C	18.00	21.00	25.00
446B	18.00	22.00	26.00

Skidders *Example equipment:* dual function arch, 100" sorting head, 30.5-32 tires, standard blade.

	O&O/hr.		
	Moderate	Average	Severe
515	\$18.00	\$27.00	\$37.00
525	19.00	28.00	40.00
528B	24.00	34.00	56.00
517	*	*	*
527	33.00	40.00	50.00

*Insufficient data.

Pipelayers *Example equipment:* front pull hook, lighting system and standard vandalism protection.

	O&O/hr.		
	Moderate	Average	Severe
561M	\$17.00	\$20.00	\$23.00
572R	30.00	36.00	54.00
583R	*	*	*
589	*	*	*

*Insufficient data.

Wheel-Tractor Scrapers *Example equipment:* standard tractor, standard scraper, standard tires.

	O&O/hr.		
	Moderate	Average	Severe
613C Series II	\$ 35.00	\$ 44.00	\$ 61.00
615C Series II	51.00	64.00	88.00
621F	45.00	60.00	94.00
623F	58.00	72.00	110.00
627F	61.00	80.00	118.00
627F PP	62.00	82.00	121.00
631E Series II	66.00	90.00	142.00
633E Series II	85.00	109.00	168.00
637E Series II	99.00	132.00	201.00
637E Series II PP	101.00	135.00	206.00
651E	74.00	98.00	151.00
657E	108.00	145.00	216.00
657PP	110.00	149.00	222.00

Construction & Mining Trucks and Tractors *Example equipment:* body liners on trucks, downshift inhibitor, standard E-3 tires, standard body (Option I — 785/789/793) with liners and standard tires. Tractors do not include trailer.

	O&O/hr.		
	Moderate	Average	Severe
769D	\$ 36.00	\$ 45.00	\$ 58.00
771D	37.00	46.00	58.00
773D	48.00	61.00	80.00
775D	50.00	63.00	82.00
776D	56.00	82.00	119.00
777D	58.00	80.00	109.00
784C	*	*	*
785C	76.00	102.00	138.00
789C	101.00	135.00	175.00
793C	121.00	161.00	206.00

*Insufficient data.

Articulated Trucks

	O&O/hr.		
	Moderate	Average	Severe
D25D	\$32.00	\$37.00	\$47.00
D30D	38.00	44.00	55.00
D250E	31.00	37.00	49.00
D300E	36.00	42.00	54.00
D350E	43.00	50.00	64.00
D400E	48.00	56.00	72.00

Owning & Operating Costs

Quick Estimators

● U.S. Dollars Per Hour

Wheel Tractors *Example equipment:* straight bulldozer, ROPS cab, lighting system, vandalism protection, standard tires.

	O&O/hr.		
	Moderate	Average	Severe
814F	\$28.00	\$32.00	\$48.00
824G	34.00	41.00	70.00
834B	51.00	58.00	92.00
844	*	*	*
854G	*	*	*

Compactors *Example equipment:* fill spreading bulldozer, ROPS canopy, lighting system, vandalism protection.

	O&O/hr.		
	Moderate	Average	Severe
815F	\$28.00	\$34.00	\$ 52.00
816F	32.00	38.00	52.00
825G	36.00	48.00	70.00
826C	48.00	56.00	82.00
836	56.00	74.00	104.00

Wheel Loaders *Example equipment:* 980 and up, standard ROPS sound suppressed cab, heater and air-conditioner. 966 and down, standard ROPS sound suppressed cab, standard tires and smallest bucket with teeth.

	O&O/hr.		
	Moderate	Average	Severe
902	*	*	*
906	*	*	*
914G	\$ 14.00	\$ 15.00	\$ 16.00
IT14G	14.00	15.00	16.00
924F	14.00	18.00	24.00
IT24F	15.00	20.00	25.00
928G	16.00	21.00	28.00
IT28G	18.00	24.00	30.00
938G	20.00	25.00	34.00
IT38G	*	*	*
950G	24.00	31.00	41.00
962G	25.00	32.00	44.00
966F Series II	31.00	41.00	62.00
970F	32.00	44.00	66.00
980G	38.00	54.00	75.00
988F Series II	60.00	81.00	109.00
990 Series II	75.00	100.00	140.00
992G	105.00	125.00	171.00
994	142.00	185.00	228.00

*Insufficient data.

Track Loaders *Example equipment:* canopy, track roller guards, front pull hook, lighting system, vandalism protection and GP bucket with teeth and segments.

	O&O/hr.		
	Moderate	Average	Severe
933C	\$12.00	\$18.00	\$26.00
939C	14.00	19.00	28.00
953C	21.00	30.00	41.00
963B	26.00	38.00	52.00
973	36.00	50.00	68.00

Paving Compactors *Example equipment:* standard equipment with working lights and all CP models equipped with leveling blades.

	O&O/hr.		
	Moderate	Average	Severe
CB-214C	\$ 5.00	\$ 8.00	\$11.00
CB-224C	8.00	11.00	18.00
CB-434C	15.00	20.00	24.00
CB-534C	18.00	24.00	26.00
CB-535B	18.00	24.00	26.00
CB-544	18.00	24.00	26.00
CB-545	18.00	24.00	26.00
CB-634C	20.00	26.00	29.00
CS-323C	11.00	18.00	22.00
CS-431C	15.00	19.00	24.00
CS-433C	16.00	22.00	31.00
CS-563C	14.00	29.00	36.00
CS-583C	16.00	29.00	36.00
CP-323C	16.00	22.00	30.00
CP-433C	18.00	29.00	35.00
CP-563C	25.00	32.00	42.00
CB-523	14.00	19.00	22.00
CB-525	14.00	19.00	22.00
PS-150	6.00	11.00	18.00
PS-200	8.00	14.00	18.00
PS-300B	12.00	18.00	22.00
PF-300B	12.00	18.00	22.00
PS-500	14.00	19.00	22.00

Road Reclaimer *Example equipment:* standard equipment with reclamation rotor.

	O&O/hr.		
	Moderate	Average	Severe
RR-250B	\$141.00	\$167.00	\$213.00
SS-250B	95.00	99.00	139.00
RM-350B	164.00	190.00	236.00

Cold Planers *Example equipment:* standard equipment with stated rotor size.

	Moderate	O&O/hr. Average	Severe
PM-465 (75" rotor)	\$227.00	\$291.00	\$368.00
PM-565B (83" rotor)	270.00	346.00	437.00

**PM-565B ESTIMATED* PRODUCTION TABLE
 (83" DRUM) LIGHT APPLICATION/
 SOFT LIME STONE AGGREGATE/
 \$232.40/O&O COST PER HR.**

Depth Of Cut	Travel Speed	Square Yards/ Hour (50 Min Hour)	Cost Per sq/yd	115 lbs/cu/ft 86 lbs/sq/ yd/inch/ depth US Tons
1"	130 FPM	4995	0.05	215
3"	90 FPM	3460	0.07	446
5"	60 FPM	2305	0.10	495
7"	35 FPM	1345	0.17	405
10"	25 FPM	960	0.24	413

**MODERATE APPLICATION
 HARD LIMESTONE AGGREGATE
 \$270.27/O&O COST PER HR.**

Depth Of Cut	Travel Speed	Square Yards/ Hour (50 Min Hour)	Cost Per sq/yd	125 lbs/cu/ft 93.75 lbs/sq/ yd/inch/ depth US Tons
1"	100 FPM	3840	0.07	180
3"	70 FPM	2690	0.10	378
5"	40 FPM	1535	0.18	360
7"	30 FPM	1155	0.23	379
10"	20 FPM	770	0.35	361

**SEVERE APPLICATION
 GRANITE/AGGREGATE
 \$436.89/O&O COST PER HR.**

Depth Of Cut	Travel Speed	Square Yards/ Hour (50 Min Hour)	Cost Per sq/yd	135 lbs/cu/ft 101.25 lbs/ sq/yd/ inch/depth US Tons
1"	70 FPM	2690	0.16	136
3"	50 FPM	1920	0.23	292
5"	30 FPM	1155	0.38	292
7"	25 FPM	960	0.45	340
10"	15 FPM	575	0.76	291

*Production and costs are estimates that are dependent on number of variables. Factors include, but are not limited to the following: percent asphalt, content, material density, ambient temperature, asphalt condition, aggregate type.

CONTENTS

Selection, application, maintenance	22-1
Tire construction	22-2
Bias ply	22-2
Radial ply	22-3
Tire types	22-3
Tire size nomenclature	22-3
Code identification for	
off-highway tires	22-4
Manufacturers' designations —	
Firestone, General, Goodyear,	
Bridgestone, Michelin	22-5
Radial tire identification:	
Michelin, Goodyear	22-7
Bridgestone	22-8
Ton-Miles Per Hour rating system	22-8
Tire Drive-Away Recommendations	22-9
T-km/h (Ton-MPH) ratings	
— Goodyear bias ply	22-10
— Bridgestone bias ply	22-12
— Goodyear radial ply	22-14
— Bridgestone radial ply	22-16
— Michelin radial ply	22-19
Tire and Rim Association ratings	22-21
Tire selection	22-21
Guide	22-22
Standard cold inflation pressures	22-22
Liquid ballasting table	22-30

SELECTION, APPLICATION, MAINTENANCE

Proper tire selection, application and maintenance continue to be the most important factors in earthmoving economics. Wheel tractors, loaders, scrapers, trucks, motor graders, etc. are earthmoving equipment whose productivity and payload unit cost may depend more on tire performance than any other factor.

Off-the-road tires must operate under a wide variety of conditions ranging from dry “potato dirt” through wet severe shot rock. Speed conditions vary from less than 1 mph average to 72 kmh (45 mph). Gradients may vary from 75% favorable to 30% adverse. Climatic conditions, operator skills, maintenance practices, etc. all may have a profound effect on tire life and unit costs.

Although one specific tire construction has proven to be more acceptable in more applications, no one tire can meet all requirements on any one machine and perhaps not even one job. The many differences in tire requirements on earthmoving machines have resulted in a wide variety of tread and carcass designs being made available. The optimum tire selection for a specific machine on a given job should be a joint decision between the user and tire supplier. Several tire manufacturers have technical and application representatives in the field for proper guidance in tire selection.

When job conditions change, it may be desirable to select a different tire configuration to meet the new requirements.

TIRE CONSTRUCTION

The pneumatic tire is essentially a flexible pressure vessel utilizing structural members (nylon, steel cable, etc.) to contain the hoop tension resulting from the inflation pressure. Rubber is utilized as a protective coating and sealant over the structural members and makes up the tread pattern which provides the wearing medium at the ground interface. The following brief explanation of the various tire constructions will assist you in selecting tires for your specific application.

Two distinct tire constructions approved on all Caterpillar machines are the BIAS PLY and RADIAL PLY tires. The following is a brief explanation of the principal features of these two constructions.

Bias Ply

1. *Beads* — The tire beads consist of steel wire-bundles (3 or 4 in larger tires) which are forced laterally by tire inflation pressure to wedge the tire firmly on the rim's tapered bead seat. The nylon plies tie into the bead bundles. The forces inherent in the tire are transmitted from the rim through the bead bundles into the nylon.
2. *Body plies* — Layers of rubber-cushioned nylon cord comprise the tire carcass. Alternating plies of cord cross the tread centerline at an angle (bias). The term "ply rating" is an index of tire strength and not the actual number of tire plies.

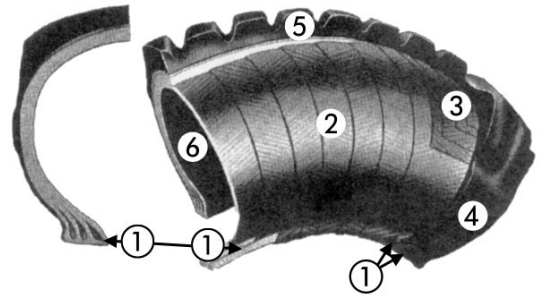

Bias Ply Construction

3. *Breakers or tread plies* — These, if used, are confined to the tire's tread area and are intended to improve carcass strength and provide additional protection to the body plies. Some "work" tires employ steel breakers or belts to further protect the carcass.
4. *Sidewalls* — These are the protective rubber layers covering the body plies in the sidewall.
5. *Tread* — The wearing part of the tire which contacts the ground. It transmits the machine weight to the ground and provides traction and flotation.
6. *Inner liner* — This is the sealing medium which retains the air and, combined with the "O" ring seal and rim base, eliminates the need for inner tubes and flaps.
7. *Tubes and flaps* — There are a few applications where tire life may be improved by using tubes and flaps (not shown).
8. *Undertread* — Protective rubber cushion lying between tread and body ply.

Radial Ply

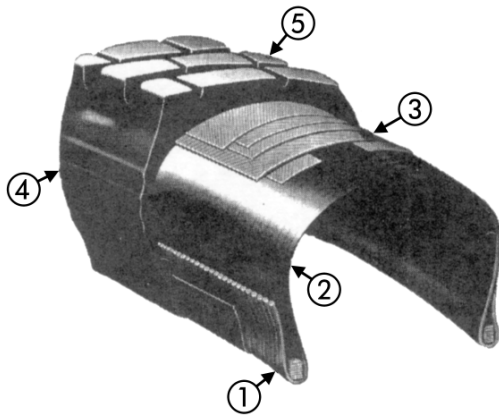

Radial Ply Construction

1. *Beads* — A single bead bundle of steel cables or steel strip (spiraled like a clock spring) comprise the bead at each rim interface.
2. *Radial carcass* — This consists of a single layer or ply of steel cables laid archwise (on the radian) bead to bead.
3. *Belts* — Several layers or plies of steel cable form the belts which underlie the tread area around the tire circumference. The cable in each belt crosses the tread centerline at an angle with the angle being reversed from the preceding belt.
4. *Sidewalls*.
5. *Tread*.
6. *Undertread* — Protective rubber cushion lying between tread and steel belts.

TIRE TYPES

Off-the-road tires are classified by application in one of the following three categories:

1. *Transport tire* — For earthmoving machines that transport material such as trucks and wheel tractors.
2. *Work tire* — Normally applied to slow moving earthmoving machines such as graders and loaders.
3. *Load and carry* — Wheel loaders engaged in transporting as well as digging.

In actual practice there are few instances where it is necessary to apply a type of tire in an application not originally intended by the tire designer. More tires are now being designed for a wide range of applications.

TIRE SIZE NOMENCLATURE

Tire size nomenclature is derived from the approximate cross section width and rim diameter with various systems being available:

1. A wide base tire, for example, is designated as a 29.5-35 with the approximate cross section width being the first number (inches) and the rim diameter the second number (inches). Industry standards permit this tire's width to be a maximum of 824 mm (32.45") in service.
2. A standard base tire, for example, is designated as a 24.00-35 with the approximate cross section width being the first number (inches) and the rim diameter the second number (inches). Industry standards permit this tire width to be a maximum 718 mm (28.27") in service.
3. A low profile tire, for example, is designated as a 40/65-39 (formerly 65/40-39 or 40-39) with the approximate cross section width being the first (40) number (inches) and the rim diameter the third (39) number (inches). The second number (65 actually is 0.65) is the aspect ratio (section height divided by section width).

If designated 40/65 R39, then the R denotes radial construction.

The wide base tire has an aspect ratio of approximately 0.83 and the standard base 0.95. The "low profile tire" has an aspect ratio of 0.65.

When comparing a wide base tire to a standard base tire, it must be remembered a larger first number on a wide base tire with the same rim diameter does not mean the wide base is larger in overall diameter. For example, the 18.00-25 standard base tire is larger in diameter than the 20.5-25 wide base. It is comparable in overall diameter to the 23.5-25 wide base.

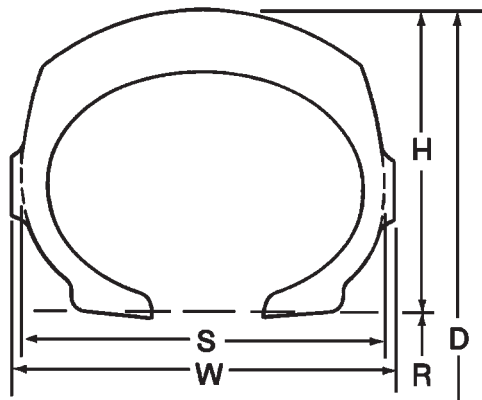

Tire cross-section

- D = Tire Overall Diameter
- R = Nominal Rim Diameter
- H = Tire Section Height
- S = Tire Section Width
- W = Tire Width (includes ornamental ribs)
- $\frac{H}{S}$ = Aspect Ratio

CODE IDENTIFICATION FOR OFF-HIGHWAY TIRES

The tire industry has adopted a code identification system to be used for off-the-road tires. This identification system will reduce the confusion caused by the trade names for each type of tire offered by each tire manufacturer. The industry code identification is divided into six main categories by types of service as follows:

- C** — Compactor Service
- E** — Earthmover Service
- G** — Grader Service
- L** — Loader & Dozer Service
- LS** — Log-Skidder Service
- ML** — Mining & Logging Service

The sub-categories are designated by numerals, as follows:

Code Identification		% Tread Depth
Compactor		
C-1	Smooth	100
C-2	Grooved	100
Earthmover		
E-1	Rib	100
E-2	Traction	100
E-3	Rock	100
E-4	Rock Deep Tread	150
E-7	Flotation	80
Grader		
G-1	Rib	100
G-2	Traction	100
G-3	Rock	100
G-4	Rock Deep Tread	150
Loader & Dozer		
L-2	Traction	100
L-3	Rock	100
L-4	Rock Deep Tread	150
L-5	Rock Extra Deep Tread	250
L-3S	Smooth	100
L-4S	Smooth Deep Tread	150
L-5S	Smooth Extra Deep Tread	250
L-5/L-5S	Half Tread Extra Deep	250
Mining & Logging		
ML-1	Rib	100
ML-2	Traction	100
ML-3	Rock	100
ML-4	Rock Deep Tread	150
Log-Skidders		
LS-1	Regular Tread	100
LS-2	Intermediate Tread	125
LS-3	Deep Tread	150
HF-4	Extra Deep Tread	250

Tire and Rim Assoc. Code	Tread Type	FIRESTONE	GENERAL	GOODYEAR	BRIDGESTONE	MICHELIN
Compactor						
C-1	Smooth Compactor	Plain Roller		Smooth Compactor	Road Roller	X LISSE X LC
C-2	Grooved Compactor			All Weather Compactor	Alligator 2	
Earthmover						
E-1	Rib	Rib Excavator	Rock Rib LCM	Hard Rock RIB		XRIB
E-2	Traction	Super Ground Grip	All Duty DTL TL100	Earthmover Sure Grip Sure Grip Lug	Fast Grip, G-Lug VKT, VFT, VGT, VLT, VHB, VSB	XV, XL, XMP, XG, XH, XS, XR
E-3	Rock	Rock Grip Excavator Super Rock Grip E67 GSR	ND LCM CM 100 SL 100 XG-3 LCM	Hard Rock Lug Hard Rock Lug-8 Super Hard Rock Lug Super Hard Rock Lug-8 HRL-3B GP-2B RL-2+ RL-3J RL-3 RL-2F RL-3+	R-Lug, W-Lug E-Lug, VE Block V-LUG 2, VMT, VEL, VRL	XK, XR XRDN XH XADN XADT XAD65-1 XHAD XZH
E-4	Rock Deep Tread	Super Rock Grip Deep Tread Rock Master Deep Tread Power Lug Deep Tread	ND Super LCM Super LCM CM 150 CRL 150 XG-4	HRL-4B RL-4 RL-4J RL-4H/4H II RL-4J II RL-4A RL-4B GP-4B GP-4D	R-Lug S, E-Lug S E-Lug S2 VELS, VRLS VMTS, VALS VZTS, VMTP	XHDI, XDT XKDI XRS
E-5	Rock Extra Deep Tread	Super Deep Tread				
E-7	Flotation	All Non-Skid EM Sand Champion Sand & Highway	Super Sand Flotation	SRB-7A	Alligator, VSJ Sand Clipper 2 S-Lug	XS XRIB
Grader						
G-1	Rib	Rib Road Builder		RBG-IA	Rib Grader	
G-2	Traction	Super Ground Grip Road Builder	Loader Grader Loader Grader II	SGG-2A SG-2B	Fast Grip, G-Lug VKT, VSW, VUT	XTL, XMPS, X SNOPLUS, XGL2, XR
G-3	Rock	Rock Grip Road Builder	ND LCM Grader	RKG-3A	R-Lug	XH, XHAD, XHF XLD70-1, XRDN
G-4	Rock Deep Tread	Super Rock Grip Deep Tread Road Builder		SGG-4B	R-Lug	XRD1, XLDD1 XLD70-1

Tire and Rim Assoc. Code	Tread Type	FIRESTONE	GENERAL	GOODYEAR	BRIDGESTONE	MICHELIN
Log-Skidder						
LS-1	Regular					
LS-2	Intermediate	Forestry Special	Tree Logger Timber Skid		Timber Grip S Fast Grip	
LS-3	Deep	Champion Spade Grip Logger	Timber Skid II			
HF-4			Timber Skid Flotation			
Loader & Dozer						
L-2	Traction	Super Ground Grip LD	Loader Grader II LD Loader Grader LD All Duty	Sure Grip Loader Sure Grip Lug D&L SGL E/L-2A GP-2B RL-2+ RL-2F	Fast Grip, VKT VLT V-Grip, VSW, VUT	XTL, XGL 2 XF, XM27, XM47 X SNOPLUS XMPS, XR
L-3	Rock	Super Rock Grip LD GSR	LD ND LCM LD 100	Super Hard Rock Loader Super Hard Rock Lug D&L Super Hard Rock Lug 8-D&L HRL E/L-3A GP-2B RL-2+	R-Lug, VMT V-Lug 2	XRDN, XH, XHAD XHF, XK, XR XLD70-1
L-4	Rock Deep Tread	Super Rock Grip Deep Tread LD	LD-150 CRB LD-150 Belted	Super Hard Rock Lug Xtra Tred D&L Nylosteel NRL D/L-4A Belted HRL D/L 4G RL-4K GP-4B	R-Lug S, VALS N-Lug, VCH R-Lug S2	XRD1, XLDD1, XMINE D1 XKD1 XLD70-1
L-5	Rock Extra Deep Tread	Super Deep Tread LD GSR	LD-250 CRB LD-250 Belted	Super Xtra Tred D&L Nylosteel NRL D/L-5A Belted RL-5K RL-4K	D-Lug M-Lug S VSDL	XRD2, XLDD2 XMINE D2
L-3S	Smooth Tread	Plain Tread LD				
L-4S	Smooth Deep Tread	Plain Tread LD		SMO D/L-4A	Smooth Tread M	XSMD 2
L-5S	Smooth Extra Deep Tread	Plain Tread LD	LD-250 Super Smooth CRB LD-250 Super Smooth Belted	SMO D/L-5A	Smooth Tread MS VSMS	
L-5/L-5S	Half Smooth	Half Tread LD	LD-250 Haf Trac CRB LD-250 Haf Trac Belted		D-Lug 2	

RADIAL TIRE IDENTIFICATION

Code Identification for Michelin Tires

All Michelin earthmover tires are radial construction, designated by the “X” marking. They contain a single steel radial ply with a series of steel belts placed around the tire’s circumference which reinforce and stabilize the tread.

Following are the tread designs currently available from Michelin with the different internal constructions depending on the application.

Type A — Cut resistant tread compound with reinforced sidewalls for work machines, mine vehicles, and slow moving transport machines on ground where there is danger of cuts, penetration, etc.

Type B — Wear and heat resistant construction for use on most transport machines.

Type C — For use on the highest speed transport machines.

A4/B4/C4 — Additional tread compounds are available for haul trucks which can optimize performance for specific site conditions.

The current combinations of tread patterns, construction, and tread depths offered, and primary TRA codes are:

Tread Design	Type A	Type B	Type C	Primary TRA Codes
XH	x	—	x	L3, G3, E3
XHD1	x	x	—	E4
XF	x	—	—	L2
XMP	—	x	—	E2
XMPS	x	—	—	G2
XTL	x	—	—	L2, G2
XGL2	x	—	—	L2, G2
XG	—	—	x	E2
XV	—	—	x	E2
XLDD1	x	—	—	L4
XLDD2	x	—	—	L5
XK	x	x	—	E3
XRDN	x	x	—	L3, E3
XRD1	x	—	—	L4, E4
XRD2	x	—	—	L5
XL	—	x	—	E2
XS	—	x	—	E7
XKD1	x	x	—	E4
XMINED1	x	—	—	L4
XMINED2	x	—	—	L5
XSMD2	x	—	—	L5S
XLISSE	—	—	x	C1

Tread Design	Type A	Type B	Type C	Primary TRA Codes
XR	x	x	—	E3, G3
XADN	x	x	—	E3
XADT	x	—	—	E4
X SNOPLUS	x	—	—	L2, G2
XDT	x	x	—	E4
XRIB	x	—	—	E1
XAD65-1	—	x	—	E3/E4
XLD70-1	x	—	—	L3/L4
XHF	x	—	—	L3
XR5	—	x	—	E3

Since Michelin radial tires contain a single steel casing ply, they utilize the industry method of designating radial tire strength in terms of “stars.” Their system consists of a one star, two star, and three star rating as an indication of the tire’s carrying capacity. The one star is the lightest construction, generally used on work and slow moving transport machines. Two star tires are used on most medium and high speed transport machines. Three star construction provides the greatest carrying capacity for a given size and is only available in small standard base tires.

This combination of tread designs and types of construction provides a range of radial tires which cover most earthmoving applications. We recommend that in applying steel radial tires to your machines you provide all data to the tire manufacturer. Obtain his recommendations as to which tire will provide the most economical operation.

Code Identification for Goodyear Radial Tires

All Goodyear steel radial earthmover tires have been designated *Unisteel* followed by a three or four digit alpha-numeric code that identifies the particular tread. The currently active codes are:

RL-2+	E 2/3 and L 2/3		
RL-2F	E2 and L2	RL-4H/HII	E4
RL-3	E3	RL-4J	E4
RL-3+	E3	RL-4JII	E4
		RL-5K	L5
RL-3J	E3 and L3	GP-2B	E2/3,
RL-4	E4		L2/3
RL-4A	E4	SG-2B	G2
RL-4B	E4	RL-4K	L4
GP-4B	E4	GP-4B	L4
GP-4D	E4		

The RL stands for Rock Lug and indicates that the upper sidewall has rock protection. The number in the code corresponds to the tire industry identification system (2-traction, 3-rock, etc). The fourth digit, if any, is used to designate tread design differences for the same basic tread type (F-directional tread).

The carcass strength is indicated by a star rating system instead of the ply rating system. These symbols indicate the recommended inflation for a particular tire load.

Following the star rating code is Goodyear's Custom Compound and Construction code. For a tire designated "2S" the 2 indicates a heat resistant compound and the S indicates standard construction and an H indicates heavy duty construction. The higher the number the greater the abrasion and cut resistance with a corresponding lower T-km/h (TON-mph) rating.

Code Identification for Bridgestone Radial Tires

The Bridgestone steel radial earthmover has been designated as V-Steel. The current nomenclature is:

V-Steel Ultra Traction	(VUT)	G2/L2
V-Steel K-Traction	(VKT)	E2/L2/G2
V-Steel F-Traction	(VFT)	E2
V-Steel L-Traction	(VLT)	E2/L2
V-Steel M-Traction	(VMT)	E3/L3
V-Steel G-Traction	(VGT)	E2
V-Steel M-Traction S	(VMTS)	E4
V-Steel R-Lug	(VRL)	E3
V-Steel R-Lug S	(VRLS)	E4
V-Steel A-Lug S	(VALS)	E4/L4
V-Steel H-Block	(VHB)	E2
V-Steel E-Lug	(VEL)	E3
V-Steel E-Lug S	(VELS)	E4
V-Steel D-Lug	(VSDL)	L5
V-Steel Smooth Tread MS	(VSMS)	L5S
V-Steel Snow Wedge	(VSW)	L2/G2
V-Steel Container Handler	(VCH)	L4
V-Steel Jamal	(VSJ)	E7
V-Steel Z-Traction S	(VZTS)	E4
V-Steel M-Traction Premium	(VMTP)	E4

Bridgestone has multiple tread compounds, with the three most commonly used being: type 1A = standard, type 2A = cut resistant and type 3A = heat resistant. The carcass strength, i.e., load carrying capacity of tire is indicated by star rating system; 1-star, 2-star and 3-star. All Bridgestone radial tires conform to the international tire standard of TRA and ETRTO.

TON-MILES PER HOUR

Tire selection and machine operating practices have, in some cases, become the critical factors in the over-all success of earthmoving ventures. The most serious problems occur when tires are operated at temperatures above their capabilities. Separation and related failures occur. To help you avoid temperature related failures, Caterpillar has been instrumental in developing the *Ton-Miles Per Hour*, (Ton-MPH) method of rating tires.

Heat and Tire Failure

Tire manufacturing requires heat in the vulcanizing process converting crude rubber and additives into a homogeneous compound. The heat required is above 132°C (270°F).

A tire also generates heat as it rolls and flexes. Heat generated faster than it can be radiated into the atmosphere gradually builds within the tire and reaches maximum level at the outermost ply or belt.

Over time, enough heat can develop from overflexing to actually reverse the vulcanizing process or "revert" the rubber causing ply separation and tire failure. Only a brief time at reversion temperature initiates the failure. Experience shows that few pure heat separation cases occur. Most so-called heat separations are in tires operating below the reversion level.

As a tire's operating temperature increases the rubber and textiles within significantly lose strength. The tire becomes more susceptible to failures from cornering, braking, impact, cut through, fatigue and heat separation. If operating tires at higher temperatures is absolutely necessary, it is essential the machines be operated to reduce the probability of premature tire failure. No hard cornering without super-elevation, no panic braking, etc.

The Ton-MPH formula was developed to predict tire temperature buildup. The system is a method of rating tires in proportion to the amount of work they can do from a temperature standpoint. It utilizes the product of *load* × *speed* to derive an index of the tire temperature buildup. Maximum tire level-off temperatures of 107°C (225°F) for fabric cord tires and 93°C (200°F) for steel wire tires are the limits Caterpillar recommends. Even at these temperatures, failures may be initiated by overstressing the tires. Some tire companies rate fabric cord tires at 111°C (232°F) and on occasion as high as 118°C (250°F). These higher temperature levels are questionable under average field conditions.

It is possible by using a needle type pyrometer to measure temperature at any desired point within the tire carcass. However, the instrumentation and the technique does not lend itself to general field use. The greatest difficulty is locating the thickest (therefore the hottest) tread bar in any given tire using giant calipers. The tire must then be drilled along the centerline of this bar from shoulder to shoulder at 52 mm (2") intervals. These 3.18 mm (1/8") diameter holes extend down through the tread and undertread to the topmost reinforcement. This procedure is fully described under SAE Recommended practice J1015.

The Ton-MPH rating system as given in this SAE specification is approved by most tire manufacturers. Michelin, in addition to providing Ton-MPH ratings has developed their own speed/load carrying rating system and we recommend that Michelin be consulted where high tire temperature with Michelin tires might be a problem.

Heat generation in a specific tire at recommended pressure depends on three factors:

- the weight the tire is carrying (flex per revolution),
- the speed the tire is traveling over the ground (flexures over a period of time), and
- the air temperature surrounding the tire (ambient temperature) and road surface temperature.

Once a tire manufacturer has determined a tire's temperature characteristics and expressed them in Ton-MPH, the above listed specific job conditions can be used to determine any tire's maximum work capacity. These conditions provide on site ability to predict and avoid costly tire separations.

Ton-Mile-Per-Hour Rating System

The tire TMPH can be matched to the site TMPH as well as compared with TMPH values of different makes and types of tires.

TMPH Job Rate

Average Tire Load × Average Speed for the shift

Average Tire Load

$$\frac{\text{"Empty" tire load} + \text{"loaded" tire load}}{2}$$

Average Speed

$$\frac{\text{Round trip distance in miles} \times \text{number of trips}}{\text{Total Hours (in the shift)}}$$

For excessive haul length (20 miles or more) consult your tire representative for modification to the TMPH value.

To use in the metric system, change miles to kilometers and use metric tons.

It should be noted that prolonged operation at high carcass temperatures can fatigue the nylon at the flex points in the sidewalls.

The following are the most recent Ton-MPH ratings as made available by Goodyear, Michelin and Bridgestone, and are subject to change on their part at any time. Other tire manufacturers' Ton-MPH ratings will be included in future handbook editions when and if made available. For latest Ton-MPH ratings, consult specific tire manufacturer at time of machine and/or tire purchase.

Load-and-Carry T-km/h (Ton-MPH)

The wheel loader, when used in load-and-carry applications, may encounter temperature problems similar to those normally associated only with tires on scrapers, trucks and wagons. **Do not place the vehicle in load-and-carry applications without first obtaining T-km/h (Ton-MPH) ratings and pressure recommendations from the tire manufacturer.**

Conventional and Radial Steel Cord Tire Options

Tire options now provide types to operate in conditions ranging from rock and abrasive materials, to jobs with high speed hauls in good materials.

The best tire type can be different for the drive tires than for other tires on the same machine. T-km/h (Ton-MPH) should be calculated for all tires.

Tire Drive-Away Recommendations

Heat separation can be a problem during machine delivery and moving machines from one job to another. Whenever roading earthmoving machines, *check your supplier for the tire manufacturer's recommended speed limitations on the specific tires involved.*

Some tire manufacturers also recommend that vehicles equipped with extra tread depth or special compounded tires should not be roaded without their specific approval. Our tests support this recommendation, especially for L-3, L-4, E-4 and L-5 tires.

Tires

T-km/h (Ton-MPH) Rating

- Goodyear Bias Ply Conventional Sizes

**T-km/h (Ton-MPH) RATINGS
AT 38° C (100° F) AMBIENT TEMPERATURE**

For Hauls of 20 Miles or Less One Way

Because of the variance between specific tires it is recommended that at the time of purchase you check with your tire supplier for the manufacturer's specific T-km/h (Ton-MPH) ratings for the tires purchased.

GOODYEAR BIAS PLY CONSTRUCTION CONVENTIONAL SIZES

Industry Code	E-1		E-2	E-3		E-4			E-7
Tread Design	Hard Rock Rib HRR-1A		Sure Grip SGL-2A	Hard Rock Lug HRL-3A Hard Rock Lug-8 HRL-3B		Hard Rock Lug XT HRL-4A Hard Rock Lug XT-8 HRL-4B			Sand Rib SRB-7A
Custom Code	2S	4S	4S	2S	4S	2S	4S	6S	4S
14.00-24 TKPH		102							
TMPH		70							
16.00-25 TKPH	182	131			102	131	95		
TMPH	125	90			70	90	65		
18.00-25 TKPH			146	182	131		117		234
TMPH			100	125	90		80		160
18.00-33 TKPH				219	161		146	124	
TMPH				150	110		100	85	
21.00-25 TKPH									270
TMPH									185
24.00-35 TKPH					255		234	204	
TMPH					175		160	140	
27.00-49 TKPH						460	328	277	
TMPH						315	225	190	
36.00-51 TKPH						679	489		628
TMPH						465	335		430

**T-km/h (Ton-MPH) RATINGS
 AT 38° C (100° F) AMBIENT TEMPERATURE**

For Haul Lengths of 20 Miles or Less One Way

GOODYEAR BIAS PLY CONSTRUCTION WIDE BASE SIZES

Industry Code	E-2	E-3			E-7	
Tread Design	Sure Grip Lug SGL E/L 2A	Super Hard Rock Lug HRL E/L 3A	Super Hard Lug 8 HRL-3B	HRL-3F	Sand Rib SRB-7A	
Custom Code	4S	2S	4S	4S	3S	4S
20.5-25 TKPH	109		95			
TKPH TMPH	75		65			
23.5-25 TKPH	131		102			
TKPH TMPH	90		70			
26.5-25 TKPH	153		131			
TKPH TMPH	105		90			
29.5-25 TKPH	182		168			248
TKPH TMPH	125		115			170
29.5-29 TKPH	197	255	182	190		
TKPH TMPH	135	175	125	130		
29.5-35 TKPH			212	234		
TKPH TMPH			145	160		
33.25-29 TKPH				204		
TKPH TMPH				140		
33.25-35 TKPH				248	234	
TKPH TMPH				170	160	
33.5-33 TKPH				248	234	
TKPH TMPH				170	160	
37.25-35 TKPH				321	307	
TKPH TMPH				220	210	
37.5-33 TKPH			299	321	307	
TKPH TMPH			205	220	210	
37.5-39 TKPH				350	328	
TKPH TMPH				240	225	

Tires

T-km/h (Ton-MPH) Rating

- Bridgestone Conventional Size

T-km/h (Ton-MPH) RATINGS AT 38° C (100° F) AMBIENT TEMPERATURE

For Haul Lengths of 32 k (20 Miles) or Less One Way
Maximum Speed Not to Exceed 48 k (30 Miles) per Hour

Because of the variance between specific tires it is recommended that at the time of purchase you check with your tire supplier for the manufacturer's specific T-km/h (Ton-MPH) ratings for the tires purchased.

BRIDGESTONE BIAS CONVENTIONAL SIZES

Industry Code	E-3			E-3			E-4			E-4			E-4		
	RL			EL			RLS			ELS			ELS2		
Custom Code	E2A	E1A	E3A	E2A	E1A	E3A	E2A	E1A	E3A	E2A	E1A	E3A	E2A	E1A	E3A
12.00-24/25	TKPH	66	80												
	TMPH	45	55												
14.00-24/25	TKPH	95	109	146			69	90							
	TMPH	65	75	100			47	62							
16.00-25	TKPH	124	139	204			97	111							
	TMPH	85	95	140			66	76							
18.00-24/25	TKPH	160	173	263			139	153					139		
	TMPH	110	119	180			95	105					95		
24.00-25	TKPH		212												
	TMPH		145												
18.00-33	TKPH	190	212	314			161	182					161	182	
	TMPH	130	145	215			110	125					110	125	
24.00-35	TKPH	292	328	460			234	277	394						
	TMPH	200	225	315			160	190	270						
24.00-49	TKPH	357	431	577			292	343	482	321	365	518			
	TMPH	245	295	395			200	235	330	220	250	355			
27.00-49	TKPH				423	496	701	336	406	547	350	409	569		
	TMPH				290	340	480	230	278	275	240	280	390		
33.00-51	TKPH						453	533	708	460	533	752			
	TMPH						310	365	485	315	365	515			
36.00-51	TKPH						526	635	847	526	649	891			
	TMPH						360	435	580	360	445	610			
40.00-57	TKPH						547	657	876	547	657	920			
	TMPH						375	450	600	375	450	630			

T-km/h (Ton-MPH) RATINGS
AT 38° C (100° F) AMBIENT TEMPERATURE
For Haul Lengths of 32 k (20 Miles) or Less One Way
Maximum Speed Not to Exceed 48 k (30 Miles) per Hour

BRIDGESTONE BIAS WIDE BASE SIZES

Industry Code		E-2			E-3			E-4		
Tread Design		FG			RL and VL2			RLS		
Custom Code		E2A	E1A	E3A	E2A	E1A	E3A	E2A	E1A	E3A
20.5-25	TKPH	109			88	95				
	TMPH	75			60	65				
23.5-25	TKPH		161		117	131		88		
	TMPH		110		80	90		60		
26.5-25	TKPH				139	161				
	TMPH				95	110				
29.5-25	TKPH				168	190	234			
	TMPH				115	130	160			
26.5-29	TKPH					190				
	TMPH					130				
29.5-29	TKPH		234		182	204		124	139	
	TMPH		160		125	140		85	95	
33.5-33	TKPH				248	285				
	TMPH				170	195				
37.5-33	TKPH					343				
	TMPH					235				
29.5-35	TKPH					255				
	TMPH					175				
33.25-35	TKPH				255	292	380			
	TMPH				175	200	260			
37.25-35	TKPH					358	467			
	TMPH					245	320			
37.5-39	TKPH				325	372	489			
	TMPH				223	255	335			

Tires

T-km/h (Ton-MPH) Rating

- Goodyear Radial Ply — Conventional Sizes

**T-km/h (Ton-MPH) RATINGS
AT 38° C (100° F) AMBIENT TEMPERATURE
For Haul Lengths of 20 Miles or Less One Way**

GOODYEAR RADIAL PLY CONSTRUCTION CONVENTIONAL SIZES

Industry Code		E-2		E-2/E-3		E-3		E-4					
		RL-2F		GP2B		RL-3+		RL-4H RL-4HII			RL-4J RL-4JII		
Tread Design													
Custom Code		2S	4S	2S	4S	2S	4S	2S	4S	6S	2S	4S	6S
14.00R25	TKPH TMPH										124 85	95 65	
16.00R25	TKPH TMPH	190 130	146 100	220 150		168 115	124 85						
18.00R25	TKPH TMPH	248 170	190 130			226 155	168 115				190 130	146 100	
18.00R33	TKPH TMPH	292 200	219 150			263 180	197 135				226 155	175 120	131 90
24.00R35	TKPH TMPH					438 300	335 230				394 270	299 205	234 160
27.00R49	TKPH TMPH			730 500	562 385	628 430	474 325	547 327	423 290	328 225	547 375	423 290	328 225
33.00R51	TKPH TMPH							715 490	540 370	321 220			
36.00R51	TKPH TMPH							788 540	598 410	358 245	788 540	598 410	358 245
37.00R57	TKPH TMPH							1022 700	781 535	460 315	1095 750	730 500	490 335
40.00R57	TKPH TMPH							1145 785	875 600	518 355			

T-km/h (Ton-MPH) RATINGS
 AT 38° C (100° F) AMBIENT TEMPERATURE
 For Haul Lengths of 20 Miles or Less One Way

GOODYEAR RADIAL PLY CONSTRUCTION WIDE BASE SIZES

Industry Code		E-2					E-3			
		AT-2A	RL-2+		RL-2F		GP-2B	RL-3	RL-3F	RL-3J
Tread Design										
Custom Code		2S	2S	4S	2S	4S	4S	4S	4S	4S
15.5R25	TKPH TMPH				146 100	109 75				
17.5R25	TKPH TMPH	190 130	146 100	109 75			151 105			124 85
20.5R25	TKPH TMPH		175 120	131 90			168 115			146 100
23.5R25	TKPH TMPH		197 135	146 100			197 135			160 110
26.5R25	TKPH TMPH		226 155	168 115			226 155			
26.5R29	TKPH TMPH									
29.5R25	TKPH TMPH		270 185	204 140			270 185			
29.5R29	TKPH TMPH		306 210	233 160	379 260	284 195		270 185		
33.25R35	TKPH TMPH				474 325	357 245				335 230
37.25R35	TKPH TMPH				547 375	416 285				379 260
37.5R39	TKPH TMPH				613 420	460 315				430 295
40.5/75R39	TKPH TMPH						445 305			
22/65R25	TKPH TMPH	284 195								
25/65R25	TKPH TMPH			182 125					182 125	
30/65R25	TKPH TMPH			160 110						

Tires

T-km/h (Ton-MPH) Rating
 ● Bridgestone Radial Ply

**T-km/h (Ton-MPH) RATINGS
 AT 38° C (100° F) AMBIENT TEMPERATURE
 For Haul Lengths of 32 k (20 Miles) or Less One Way
 Maximum Speed Not to Exceed 48 k (30 Miles) per Hour**

BRIDGESTONE RADIAL PLY

Industry Code	E-4			E-4			E-4		
Tread Design	VMTS			VRLS/VWTS			VELS		
Custom Code	E2A	E1A	E3A	E2A	E1A	E3A	E2A	E1A	E3A
14.00R24 TKPH	91	119	136						
TKPH	62	82	93						
14.00R25 TKPH	91	119	136	85	112	128			
TKPH	62	82	93	58	77	88			
16.00R25 TKPH	123	157	179	112	146	165			
TKPH	84	108	123	77	100	115			
18.00R25 TKPH	169	209	244				144	179	209
TKPH	116	143	167				99	123	143
15.00R33 TKPH	199	246	287				170	211	246
TKPH	136	158	197				116	145	168
24.00R35 TKPH	338	415	489	314	358	453			
TKPH	232	286	335	215	266	310			
27.00R49 TKPH	486	600	702	415	513	600			
TKPH	333	411	481	284	351	411			
33.00R51 TKPH	660	815	953	558	690	807			
TKPH	452	558	653	382	473	553			
36.00R51 TKPH				642	793	927			
TKPH				440	543	635			
37.00R57 TKPH				694	858	1003			
TKPH				475	588	687			
40.00R57 TKPH							773	955	1117
TKPH							529	654	765

NOTE: For cycle lengths of 5 km (3 miles) or less (round trip), multiply the T-km/h (Ton-MPH) value in this table by 1.12.

**T-km/h (Ton-MPH) RATINGS
 AT 38° C (100° F) AMBIENT TEMPERATURE**
**For Haul Lengths of 32 k (20 Miles) or Less One Way
 Maximum Speed Not to Exceed 48 k (30 Miles) per Hour**

BRIDGESTONE RADIAL PLY

Industry Code		E-2			E-2/E-3			E-3			E-3		
Tread Design		VHB			VKT/VFT			VRL/VEL			VMT		
Custom Code		E2A	E1A	E3A	E2A	E1A	E3A	E2A	E1A	E3A	E2A	E1A	E3A
14.00R24	TKPH	136	179	205	106	141	159						
	TMPH	93	123	140	73	97	109						
14.00R25	TKPH	136	179	205									
	TMPH	93	123	140									
16.00R25	TKPH	179	235	269	134	179	202						
	TMPH	123	161	184	92	123	138						
18.00R25	TKPH				193	239	280	181	224	262			
	TMPH				132	164	192	124	153	179			
18.00R33	TKPH				227	281	328	213	263	307			
	TMPH				155	192	225	146	180	210			
24.00R35	TKPH				386	477	558	362	448	524			
	TMPH				264	327	382	248	307	359			
27.00R49	TKPH				557	688	804	521	644	753			
	TMPH				382	471	551	357	441	516			
33.00R51	TKPH										837	1034	1209
	TMPH										573	708	828
36.00R51	TKPH										974	1203	1407
	TMPH										667	824	964

NOTE: For cycle lengths of 5 km (3 miles) or less (round trip), multiply the T-km/h (Ton-MPH) value in this table by 1.12.

Tires

T-km/h (Ton-MPH) Rating
 ● Bridgestone Radial Ply

**T-km/h (Ton-MPH) RATINGS
 AT 38° C (100° F) AMBIENT TEMPERATURE**
**For Haul Lengths of 38 k (20 Miles) or Less One Way
 Maximum Speed Not to Exceed 48 k (30 Miles) per Hour**

BRIDGESTONE RADIAL PLY

Industry Code		E-2/E-3			E-3			E-3			E-4		
Tread Design		VKT			VMT			VRL/VAL			VALS		
Custom Code		E2A	E1A	E3A	E2A	E1A	E3A	E2A	E1A	E3A	E2A	E1A	E3A
17.5R25	TKPH	95	125	145	90	117	138						
	TMPH	65	86	99	62	80	95						
17.5R25	TKPH	120	154	180	114	144	171						
	TMPH	82	105	123	78	99	117						
20.5R25	TKPH	129	166	193	120	157	184	110	147	165	92	119	138
	TMPH	58	114	132	82	108	126	75	101	113	63	82	95
20.5R25	TKPH	160	206	240	149	194	229	137	182	205	114	148	171
	TMPH	110	141	164	102	133	157	94	125	140	78	101	117
23.R25	TKPH	166	213	247	153	201	236	141	188	212	117	153	176
	TMPH	114	146	169	105	138	162	57	129	145	80	105	121
23.R25	TKPH	205	263	307	190	245	292	175	233	262	146	189	219
	TMPH	140	180	210	130	170	200	120	160	179	100	129	150
26.5R25	TKPH	257	312	349	220	293	330				165	220	256
	TMPH	176	214	239	151	201	226				113	151	175
29.5R25	TKPH	310	376	421	266	354	399						
	TMPH	212	258	288	182	242	273						
29.5R29	TKPH	330	401	449							212		
	TMPH	226	275	308							145		
33.25R29	TKPH	407	494	552				319	435	493			
	TMPH	279	338	378				215	298	338			
33.5R33	TKPH	444	539	603									
	TMPH	304	369	413									
37.5R33	TKPH	534	648	724									
	TMPH	366	444	496									
29.5R35	TKPH							279	380	431			
	TMPH							191	260	295			
33.25R35	TKPH	441	536	599				346	472	535			
	TMPH	302	367	410				237	323	366			
37.25R35	TKPH	530	644	720				413	563	638			
	TMPH	363	441	493				283	386	437			
37.5R39	TKPH	573	696	778									
	TMPH												
26/65R25	TKPH	162	205	243									
	TMPH												

NOTE: For cycle lengths of 5 km (3 miles) or less (round trip), multiply the T-km/h (Ton-MPH) value in this table by 1.12.

T-km/h (Ton-MPH) RATINGS
 AT 38° C (100° F) AMBIENT TEMPERATURE
 For Haul Cycles Less than 5 km (3 Miles) Round Trip*

MICHELIN RADIAL PLY CONSTRUCTION STANDARD BASE TIRES

Industry Code		E-2			E-3			E-4					
Tread Design		XV	XR	XK	XDT				XKD1				
Type		C	B	B	A4	A	B4	B	A4	A	B4	B	
18.00R33	TKPH	436	305	279	157	192		262	122	157		227	
	TMPH	299	209	191	108	132		179	84	108		155	
24.00R35	TKPH	740	518	474	266	326		444	207	266		385	
	TMPH	507	355	325	182	223		304	142	182		264	
27.00R49	TKPH	1090	763	698	392	480	567	654		392	480	567	
	TMPH	747	523	478	269	329	388	448		269	329	388	
33.00R51	TKPH				558	682	806	930		496	620	744	
	TMPH				382	590	552	804		340	425	644	
36.00R51	TKPH		1295	1184						592	740	888	
	TMPH		887	811						406	507	608	
37.00R57	TKPH									678	848	1018	
	TMPH									464	581	697	
40.00R57	TKPH									268	960	1152	
	TMPH									526	658	789	

*Consult Michelin for TKPH (**TMPH**) ratings for haul cycles greater than 5 km (3 m).

NOTE: Additional tread compounds are available to meet specific T-km/h (**TMPH**).

Tires

- T-km/h (Ton-MPH) Rating
- ISO Load Index Speed Symbol
- Michelin Radial Ply — Wide Base Sizes

**T-km/h (Ton-MPH) RATINGS
AT 38° C (100° F) AMBIENT TEMPERATURE
For Haul Cycles Less than 5 km (3 miles) Round Trip***

MICHELIN RADIAL PLY CONSTRUCTION WIDE BASE SIZES

Industry Code		E-3			E-4
Tread Design		XR	XRDN		XRS
Type		B	A	B	B
25/65R25 Low Profile	TKPH	217			
	TMPH	149			
29.5R29	TKPH	420			
	TMPH	288			
33.25R29	TKPH	518			
	TMPH	355			
33.5R33	TKPH	560			
	TMPH	384			
37.5R33	TKPH	680			
	TMPH	466			
29.5R35	TKPH	448			
	TMPH	307			
33.25R35	TKPH	560			
	TMPH	384			
37.25R35	TKPH	661			415
	TMPH	453			284
37.5R39	TKPH	721			
	TMPH	494			
40.5/75R39	TKPH		534	766	766
	TMPH		366	525	525

*Consult Michelin for TKPH (**TMPH**) ratings on haul cycles greater than 5 km (3 m).

**ISO Load Index Speed Symbol
AT 38° C (100° F) AMBIENT TEMPERATURE
For Haul Lengths Greater than 3 Miles (Round Trip)**

MICHELIN RADIAL PLY CONSTRUCTION WIDE BASE SIZES

Industry Code	E-3	E-3 (DT)	E-3
Tread Design	XADN	XADT	XAD65-1
Type			
20.5R25	177B	177B	
23.5R25	185B	185B	
26.5R25	193B	193B	
29.5R25	200B	200B	
750/65R25 Low Profile			190B

TIRE AND RIM ASSOCIATION RATINGS

While the T-km/h (Ton-MPH) Rating System provides a method to determine the tire's work capacity, Tire and Rim Association Ratings provide a guide for evaluating a tire's structural capacity. These two rating systems should be used in conjunction to evaluate tire performance.

TIRE SELECTION

Selecting the optimum tire for a given application is particularly critical for earthmoving. The machines have the capability to outperform the tires and, unless proper practices are observed, very costly premature tire failures can occur. Job conditions vary greatly throughout the world, as well as within any given job site, and selecting the optimum tire requires careful consideration of all factors involved. In general, the tire manufacturer should be consulted before making the selection for any given application. In some cases, the tire manufacturer can fabricate tires specifically tailored for a given job site.

For those applications where wear is extremely slow, especially as a result of only occasional operation throughout the year, the cheapest lightweight tire needs to be given strong consideration.

As job conditions become severe, the following factors should be evaluated in selecting a tire:

Transport or Load-and-carry —

- T-km/h (Ton-MPH) (primary consideration)
- Minimum approved ply rating or greater
- Largest optional size
- Thickest tread commensurate with T-km/h (Ton-MPH)
- Largest practical bar to gap ratio
- Most cut resistant tread commensurate with T-km/h (Ton-MPH)
- Belted construction

Loader or Dozer —

- Minimum approved ply rating or greater
- Largest optional size
- Thickest tread
- Thickest available undertread
- Buttressed shoulder
- Most cut resistant tread
- Largest practical bar to gap ratio
- Belted construction
- Lowest aspect ratio

All tires should be operated at the tire manufacturer's recommended inflation pressure for a given application. Inflation pressure should be checked every working day with an accurate Bourden-tube type gauge. This gauge should be checked against a known standard such as a dead weight tester at least once a month.

Excess loads may result from factors such as varying material density, field modifications to equipment, mud accumulation, load transfer, etc. Only under these conditions may the actual in service tire load exceed the rated machine load. When excess loads are encountered, cold inflation pressures **must** be increased to compensate for higher loads. Increase tire inflation pressure 2% for each 1% increase in load.

	Maximum Excess Load	Pressure
Bias Ply	15%	30%
Radial Ply	7%	14%

The above loads will result in reduced tire performance and must be approved by the tire manufacturer.

The use of chains is difficult to justify except under a few conditions. Chains are very costly and heavy, and require more maintenance than most operations can provide. On some models sufficient clearance does not exist for chains with all tire combinations. Extensive modifications may be required if chains are needed for the job.

Foam filling tires is normally not recommended due to high cost and lack of local filling facilities. Its use should be confined to loader and dozer applications where penetrations occur almost daily. If foam is used be sure to adhere to recommended equivalent pressures of nitrogen and use highest available ply rating.

- Guide
- Standard Cold Inflation Pressures

TIRE SELECTION GUIDE

Material	Road or ground condition	Treads	
		Wheel Tractor-Scrapers	Wheel Tractors or Wheel Loaders
Silt and clay, No Rock, High moisture content.	Good varying to poor. High rolling resistance.	Traction Type (E-2).	Traction Type (L-2).
Silt and Clay, Some rock, Variable moisture content.	Good varying to poor.	Rock-type (E-3) best unless traction is a problem — then use traction tires (E-2). Rock-type offers more resistance to cutting.	Rock-type (L-3, L-4 or L-5) best unless traction is a problem — then use traction (L-2) tires. Rock-type offers more resistance to cutting.
Silty or clayey gravel and sand, Low moisture content.	Excellent to good. Firm surface.	Rock-type (E-3) offers better wear.	Rock-type (L-3, L-4 or L-5) offers better wear.
Silty or clayey gravel and sand, High moisture content.	Poor, rutted, pot holes.	Rock-type (E-3).	Rock-type (L-3, L-4 or L-5).
Blasted rock.	Hard surface, rough.	Rock-type (E-3 or L-3 and L-4 if possible).	Rock-type (L-5 or L-5S).
Sand Very low silt or clay content.	Good to fair surface.	Rock-type (E-3 or L-3S and L-4S if possible) with low pressure. Creates minimum soil disturbance resulting improved flotation.	Rock-type (L-3 or L-3S) with low pressure. Creates minimum soil disturbance resulting in improved flotation.

TIRE SUPPLIER RECOMMENDED COLD INFLATION PRESSURES

The following tables present Caterpillar and the *tire suppliers'* recommended cold inflation pressures for tires on Caterpillar machines. An asterisk (*) indicates the standard tire size and ply rating.

The inflation pressure is based on a ready-to-work vehicle weight with no attachments, rated payload, and average operating conditions. **Pressures for each application may need to be varied from those shown and should always be obtained from your tire supplier.**

Pressures for all tires apply to rib, traction, rock, deep tread, and super deep tread tires.

NOTE: Caterpillar now recommends using dry nitrogen (N₂) gas for both tire inflation and pressure adjustments on all current and past production machines.

EXCAVATORS — Bias Ply

For complete tire data and inflation pressures, see the Excavator section in this handbook.

SKIDDERS — Bias Ply

Model	Tire Size	Ply Rating	Pressure			
			Front		Rear	
			kPa	psi	kPa	psi
525	28L-26	14	172	25	172	25
	24.5-32	16	207	30	207	30
	30.5-32	16	172	25	172	25
528B	24.5-32	16	210	30	210	30
	30.5L-32	16	170	25	170	25
530B	24.5-32	16	210	30	210	30
	30.5L-32	16	170	25	170	25

MOTOR GRADERS — Bias Ply

Model	Tire Size	Ply Rating	Pressure			
			Front		Rear	
			kPa	psi	kPa	psi
120H	13.00-24TG*	10*, 12	241	35	241	35
	14.00-24TG		241	35	241	35
	15.5-25	10, 12	241	35	241	35
	17.5-25		241	35	241	35
135H	13.00-24TG*	10*, 12	241	35	241	35
	14.00-24TG		241	35	241	35
	15.5-25	12	276	40	276	40
	17.5-25		241	35	241	35
12H	13.00-24TG*	12	310	45	310	45
	14.00-24TG		241	35	241	35
	15.5-25	12	241	35	241	35
	17.5-25		276	40	276	40
140H	14.00-24TG*	10*, 12	241	35	241	35
	17.5-25		241	35	241	35
143H	14.00-24TG*	10*, 12	241	35	241	35
	17.5-25		241	35	241	35
160H	14.00-24TG*	10, 12*	241	35	241	35
	17.5-25		241	35	241	35
163H	14.00-24TG*	12	241	35	241	35
	17.5-25		241	35	241	35

*Standard tire and ply rating.

MOTOR GRADERS — Bias Ply (continued)

Model	Tire Size	Ply Rating	Pressure			
			Front		Rear	
			kPa	psi	kPa	psi
14H	16.00-24TG*	16	310	45	310	45
		16	241	35	241	35
16H	18.00-25*	16	241	35	241	35
		16	241	35	241	35
	23.5-25					

*Standard tire and ply rating.

WHEEL TRACTORS — Bias Ply

Model	Tire Size	Ply Rating or Strength Index	Pressure			
			Front		Rear	
			kPa	psi	kPa	psi
814F	23.5-25*	12	207	30	207	30
		14	172	25	172	25
824G	29.5-25*	22	241	35	241	35
834B	35/65-33*	24	241	35	241	35

WHEEL TRACTOR — Radial Ply

814F	23.5R25	★	276	40	276	40
	26.5R25	★	241	35	241	35
824G	29.5R25	★	345	50	345	50
834B	3565R33	★	345	50	345	50

*Standard tire, ply rating, and inflation pressures.

MOTOR GRADERS — Michelin, Goodyear and Bridgestone/Firestone Radial Ply

Model	Tire Size	Strength Rating	Michelin Pressure				Goodyear Pressure				Bridgestone Pressure			
			Front		Rear		Front		Rear		Front		Rear	
			kPa	psi	kPa	psi	kPa	psi	kPa	psi	kPa	psi	kPa	psi
120H	13.00R24TG	★	310	45	310	45	310	45	310	45	310	45	310	45
	14.00R24TG	★	310	45	310	45	310	45	310	45	310	45	310	45
	15.5R25	★	310	45	310	45	310	45	310	45	310	45	310	45
135H	13.00R24TG	★	310	45	310	45	310	45	310	45	310	45	310	45
	14.00R24TG	★	310	45	310	45	310	45	310	45	310	45	310	45
	15.5R25	★	310	45	310	45	310	45	310	45	310	45	310	45
12H	13.00R24TG	★	310	45	310	45	310	45	310	45	310	45	310	45
	14.00R24TG	★	310	45	310	45	310	45	310	45	310	45	310	45
	15.5R25	★	310	45	310	45	310	45	310	45	310	45	310	45
140H	14.00R24TG	★	310	45	310	45	310	45	310	45	310	45	310	45
	17.5R25	★	310	45	310	45	310	45	310	45	310	45	310	45
160H	14.00R24TG	★	310	45	310	45	310	45	310	45	310	45	310	45
	17.5R25	★	310	45	310	45	310	45	310	45	310	45	310	45
143H	14.00R24TG	★	310	45	310	45	310	45	310	45	310	45	310	45
	17.5R25	★	310	45	310	45	310	45	310	45	310	45	310	45
163H	14.00R24TG	★	310	45	310	45	310	45	310	45	310	45	310	45
	17.5R25	★	310	45	310	45	310	45	310	45	310	45	310	45
14H	16.00R24TG	★	310	45	310	45	310	45	310	45	310	45	310	45
	20.5R25	★	310	45	310	45	310	45	310	45	310	45	310	45
16H	18.00R25	★	310	45	310	45	310	45	310	45	310	45	310	45
	23.5R25	★	310	45	310	45	310	45	310	45	310	45	310	45

BACKHOE LOADERS (Front)

Tire Size	Ply/Star Rating	Pressure	
		kPa	psi
9x16 F2	10	415	60
11Lx16 F3	10	360	52
	12	440	64
14.5/75x16.1 F3	10	280	41
12.5/80-18 I3 SG LUG	10	310	45
12.5x20 R4	10	350	51
340/80R18 IT510	★	330	48
335/80R18 XM27 139	★	330	48
15-19.5 SSSG	8	275	40

BACKHOE LOADERS (Rear)

Tire Size	Ply/Star Rating	Pressure	
		kPa	psi
16.9x24 R4	8	195	28
	10	220	32
19.5x24 IT525	8	165	24
	10	195	28
19.5LR24 IT510	★	275	40
16.9x28 R4	10	220	32
	12	260	38
16.9/14x28 R1	12	235	34
16.9R28 IT510	★	275	40
16.9R28 XM27	★	275	40
18.4/15x26 R4	12	250	36
18.4/15x26 XM27	★	275	40
21Lx24 IT525	12	220	32

PAVING PRODUCTS — Bias Ply

Model	Tire Size	Ply Rating	Pressure			
			Front		Rear	
			kPa	psi	kPa	psi
PS-150	7.50-15	6, 12, 14 12, 14	*	*		
PS-210	7.50-15		*	*		
PF-300	13.80-20/E20		*	*		
PS-300	E20 Pilotex (13/80-20)		*	*		
PS-500	15.00R24		*	*		
CS-323C	11.2-24	6	—	—	138	20
CP-323C	11.2-24	6	—	—	138	20
CS-431C	14.9-24	6	—	—	138	20
CS-433C	14.9-24	6	—	—	138	20
CP-433C	14.9-24	6	—	—	138	20
CS-563C	23.1-26	8	—	—	138	20
CP-563C	23.1-26	8	—	—	138	20
CS-573C	23.1-26	8	—	—	138	20
CS-583C	23.1-26	8	—	—	138	20
CB-525B	15.00-24	★ ★ ★	—	—	100	20
CB-523B	15.00-24	★ ★ ★	—	—	100	20
CS-583C	23.1-26	8	—	—	83	20
CS-533C	23.1-26	8	—	—	83	20
CP-533C	23.1-28	8	—	—	241	20
RR-250	23.5-25	16	310	45	—	—
	15.5-25	8	—	—	205	30
SS-250	28.1-26	10	165	24	—	—
	14.9-24	6	—	—	124	18
RM-350	23.5-25	16	310	45	—	—
	15.5-25	8	—	—	205	30
SM-350	28.1-26	10	241	35	—	—
	14.9-24	6	—	—	124	18
AP-800B	16.00-24	12	—	—	241	35
AP-1000	18.00-25	16	—	—	241	35

*Tire pressure varies with application.

WHEEL TRACTOR-SCRAPERS — Bias Ply

Model	Tire Size	Ply Rating	Pressure			
			Front		Rear	
			kPa	psi	kPa	psi
613C Series II	23.5-25	20	310	45	310	45
615C Series II	29.5-25	28	324	47	310	45
	29.5-25	34	448	65	380	55
621F	33.25-29	26	380	55	310	45
	29.5-29	34	413	60	310	45
	29.5-35	28	380	55	275	40
623F	29.5-29	34	450	65	345	50
	29.5-35	28	413	60	310	45
627F	29.5-29	34	413	60	450	65
	29.5-35	34	345	50	380	55
631E Series II	37.25-35	42	413	60	380	55
633E Series II	37.25-35	42	413	60	380	55
637E Series II	37.25-25	42	413	60	380	55

ARTICULATED TRUCK — Radial Ply

Model	Tire Size	Ply Rating	Pressure					
			Front		Center		Rear	
			kPa	psi	kPa	psi	kPa	psi
D25D	26.5R25	★ ★	400	58	—	—	450	65
D30D	29.5R25	★ ★	325	47	—	—	450	65
D250E	20.5R25	★ ★	375	54	450	65	450	65
	23.5R25	★ ★	275	40	325	47	325	47
D300E	23.5R25	★ ★	325	47	400	58	400	58
	30/65R25	★ ★	275	40	350	51	350	51
D350E	26.5R25	★ ★	375	54	350	51	350	51
	29.5R25	★ ★	300	44	300	44	300	44
D400E	26.5R25	★ ★	400	58	425	62	425	62
	29.5R25	★ ★	300	44	330	48	330	48

WHEEL TRACTOR-SCRAPERS — Radial Ply

Model	Tire Size	Strength Index	Pressure											
			Michelin				Goodyear				Bridgestone			
			Front		Rear		Front		Rear		Front		Rear	
613C Series II	18.00R25	★	kPa	psi	kPa	psi	kPa	psi	kPa	psi	kPa	psi	kPa	psi
	23.5R25	★	413	60	413	60	413	60	450	65	485	70	485	70
615C Series II	26.5R25	★ ★	450	65	450	65	485	70	480	70	517	75	517	75
	29.5R25	★	345	50	345	50	380	55	380	55	413	60	413	60
621F	29.5R29	★ ★	450	65	380	55	480	70	380	55	517	75	413	60
	29.5R35	★ ★	450	65	380	55	—	—	—	—	450	65	380	55
	33.25R29	★ ★	413	60	345	50	413	60	345	50	413	60	345	50
623F	29.5R29	★ ★	485	70	413	60	517	75	413	60	517	75	517	75
	29.5R35	★ ★	450	65	380	55	—	—	—	—	517	75	450	65
627F	29.5R29	★ ★	413	60	413	60	517	75	517	75	517	75	517	75
	29.5R35	★ ★	413	60	413	60	—	—	—	—	517	75	517	75
	33.25R29	★ ★	380	55	380	55	380	55	380	55	413	60	413	60
631E Series II	37.25R35	★ ★	517	75	413	60	517	75	413	60	517	75	413	60
633E Series II	37.25R35	★ ★	517	75	517	75	517	75	517	75	517	75	517	75
637E Series II	37.25R35	★ ★	517	75	517	75	517	75	517	75	517	75	517	75
651E	37.5R39	★ ★	620	90	550	80	620	90	515	75	620	90	550	80
	40.5/75R39	★ ★	517	75	450	65	517	75	450	65	517	75	450	65
657E	37.5R39	★ ★	690	100	690	100	690	100	690	100	690	100	690	100
	40.5/75R39	★ ★	517	75	517	75	550	80	550	80	550	80	550	80

22

CONSTRUCTION & MINING TRUCKS & TRACTORS — Radial Ply

Model	Tire Size	Strength Index	Pressure											
			Michelin				Goodyear				Bridgestone			
			Front		Rear		Front		Rear		Front		Rear	
769D	18.00R33*	★ ★	kPa	psi	kPa	psi	kPa	psi	kPa	psi	kPa	psi	kPa	psi
			655	95	655	95	725	105	725	105	725	105	725	105
771D	18.00R33*	★ ★	760	110	760	110	825	120	825	120	825	120	825	120
773D	24.00R35*	★ ★	515	75	515	75	550	80	550	80	585	85	585	85
775D	24.00R35*	★ ★	585	85	585	85	620	90	620	90	655	95	655	95
776D	27.00R49*	★ ★	585	85	585	85	585	85	585	85	620	90	620	90
777D	27.00R49*	★ ★	585	85	585	85	655	95	655	95	620	90	620	90
784B	36.00R51*	★ ★	655	95	655	95	725	105	690	100	725	105	725	105
785B	33.00R51*	★ ★	725	105	725	105	725	105	725	105	725	105	725	105
789B	37.00R57*	★ ★	655	95	655	95	725	105	725	105	725	105	725	105
793C	40.00R57*	★ ★	655	95	655	95	760	110	760	110	760	110	760	110

*Standard tire and ply rating.

Tires

Standard Cold Inflation Pressures Bias and Bias Belted

- Wheel Loaders
- Log Loaders
- Integrated Tool Carriers
- Telehandlers

WHEEL LOADERS — Bias and Bias Belted

Model	Tire Size	Ply Rating or Strength Index	Pressure			
			Front		Rear	
			kPa	psi	kPa	psi
914G	15.5-25	12	275	40	175	25
	15.5-25	12	225	33	175	25
924F	17.5-25	12	225	33	175	25
	20.5-25	12	225	33	175	25
928G	17.5-25	12	325	47	225	33
	20.5-25	12	225	33	175	25
938G	20.5-25	12	345	50	241	35
950G	23.5-25	16	414	60	241	35
962G	23.5-25	16	414	60	241	35
966G	26.5-25	20	448	65	241	35
972G	26.5-25	20	448	65	241	35
980G	29.5-25	22	414	60	241	35
	29.5-25	28	517	75	241	35
988F Series II	35/65-33*	30	552	80	276	40
990 Series II	41.25/70-39	34	483	70	276	40
	41.25/70-39	42	483	70	276	40
992G	45/65-45	46	621	90	276	40
994	50/80-57	68	690	100	585	85
	55.5/80-57	68	690	100	585	85

*Higher ply ratings are recommended for High Lift Machines.
NOTE: Tire pressure on front tires of front end loaders may be increased up to 100 kPa (15 psi).

LOG LOADERS — Bias and Bias Belted

Model	Tire Size	Ply Rating	Inflation Pressure			
			Front		Rear	
			kPa	psi	kPa	psi
914G	15.5-25	12	300	44	200	29
	17.5-25	12	250	36	175	25
924F	17.5-25	12	250	36	175	25
	20.5-25	12	225	33	175	25
928G	17.5-25	12	350	50	250	36
	20.5-25	12	250	36	200	29
938G	20.5-25	12	448	65	241	35
950G	23.5-25	16	414	60	241	35
966G	26.5-25	20	448	65	241	35
	23.5-25	24	586	85	241	35
980G	29.5-25	28	552	80	241	35
988F Series II	35/65-33	30	552	80	276	40

INTEGRATED TOOL CARRIERS — Bias and Bias Belted

Model	Tire Size	Ply Rating	Inflation Pressure			
			Front		Rear	
			kPa	psi	kPa	psi
IT14G	15.5-25	12	300	44	200	29
	17.5-25	12	250	36	175	25
IT24F	15.5-25	12	275	40	175	25
	17.5-25	12	225	33	175	25
IT28G	17.5-25	12	325	47	225	33
	20.5-25	12	225	33	175	25
IT38G	20.5-25	12	345	50	241	35
	20.5-25	16	483	70	241	35

TELEHANDLERS — Bias and Bias Belted

Model	Tire Size	Ply Rating or Strength Index	Inflation Pressure			
			Front		Rear	
			kPa	psi	kPa	psi
TH62	13.0-24	12	310	45	310	45
	15.5/80-24	10	310	45	310	45
	15.5-25	12	276	40	276	40
TH82	13.0-24(ANSI)	12	380	55	380	55
	13.0-24(FEM)	12	448	65	448	65
	15.5/80-24	10	415	60	415	60
	15.5-25	12	345	50	345	50
TH63	13.0-24	12	380	55	380	55
	15.5/80-24	12	345	50	345	50
	15.5-25(ANSI)	12	415	60	415	60
	15.5-25(FEM)	12	415	60	415	60
TH83	14.0-24	12	415	60	415	60
	17.5-25	12	345	50	345	50
TH103	14.0-24	12	518	75	518	75
	17.5-25	12	485	70	485	70

WHEEL LOADERS — Radial Ply

Model	Tire Size	Strength Index	Pressure											
			Michelin				Goodyear				Bridgestone			
			Front		Rear		Front		Rear		Front		Rear	
		kPa	psi	kPa	psi	kPa	psi	kPa	psi	kPa	psi	kPa	psi	
914G	15.5R25	★	250	36	175	25	—	—	—	—	—	—	—	—
	17.5R25	★	200	29	175	25	400	58	300	44	—	—	—	—
924F	17.5R25	★	225	33	175	25	400	58	300	44	—	—	—	—
	555/70R25	★	200	29	175	25	—	—	—	—	—	—	—	—
	20.5R25	★	200	29	175	25	400	58	300	44	—	—	—	—
928G	17.5R25	★	375	54	200	29	400	58	300	44	—	—	—	—
	555/70R25	★	250	36	175	25	—	—	—	—	—	—	—	—
	20.5R25	★	250	36	175	25	400	58	300	44	—	—	—	—
938G	20.5R25	★	276	40	207	30	276	40	241	35	—	—	—	—
950G	23.5R25	★	276	40	207	30	310	45	207	30	414	60	310	45
962G	23.5R25	★	310	45	207	30	345	50	207	30	414	60	310	45
966G	26.5R25	★	345	50	207	30	345	50	207	30	414	60	310	45
972G	26.5R25	★	414	60	207	30	414	50	276	40	414	60	310	45
			414	60	207	30	448	65	310	45	485	70	380	55
980G	26.5R25	★	345	50	207	30	345	50	207	30	414	60	310	45
			29.5R25	★	345	50	207	30	345	50	207	30	414	60
988F Series II	35/65R33	★	483	70	207	30	483	70	345	50	585	85	450	65
990 Series II	45/65R39	★	552	80	276	40	—	—	—	—	—	—	—	—
	40.5/75R39	★	—	—	—	—	483	70	345	50	—	—	—	—
992G	45/65R45	★	552	80	276	40	—	—	—	—	585	85	450	65
994	55/80R57	—	689	100	552	80	—	—	—	—	—	—	—	—

NOTE: Tire pressure on front tires of front end loaders may be increased up to 100 kPa (15 psi).

TELEHANDLERS — Radial Ply

Model	Tire Size	Ply Rating or Strength Index	Pressure							
			Michelin				Goodyear			
			Front		Rear		Front		Rear	
		kPa	psi	kPa	psi	kPa	psi	kPa	psi	
TH62	17.5LR24	★	—	—	—	—	276	40	276	40
TH82	445/70R24	★	310	45	310	45	—	—	—	—
	495/70R24	★	276	40	276	40	—	—	—	—
TH83	15.5R25	★	—	—	—	—	518	75	518	75
	17.5R25	★	—	—	—	—	415	60	415	60
TH103	17.5R25	★	—	—	—	—	518	75	518	75

Tires

Standard Cold Inflation Pressures

Radial Ply

- Log Loaders
- Integrated Tool Carriers

LOG LOADERS — Radial Ply

Model	Tire Size	Strength Index	Pressure											
			Michelin				Goodyear				Bridgestone			
			Front		Rear		Front		Rear		Front		Rear	
		kPa	psi	kPa	psi	kPa	psi	kPa	psi	kPa	psi	kPa	psi	
914G	15.5R25	★	275	40	175	25	—	—	—	—	—	—	—	—
	17.5R25	★	225	33	175	25	400	58	300	44	—	—	—	—
924F	17.5R25	★	275	40	175	25	400	58	300	44	—	—	—	—
	555/70R25	★	200	29	175	25	—	—	—	—	—	—	—	—
	20.5R25	★	200	29	175	25	400	58	300	44	—	—	—	—
928G	17.5R25	★	400	58	225	33	400	58	300	44	—	—	—	—
	555/70R25	★	275	40	275	40	—	—	—	—	—	—	—	—
	20.5R25	★	275	40	275	40	400	58	300	44	—	—	—	—
938G	20.5R25	★	310	45	207	30	345	50	276	40	—	—	—	—
950G	23.5R25	★	414	60	207	30	414	60	276	40	414	60	310	45
966G	26.5R25	★	414	60	207	30	414	60	276	40	415	60	310	45
980G	29.5R25	★	448	65	207	30	438	70	276	40	485	70	345	50
988F Series II	35/65R33	★	552	80	241	35	655	95	310	45	665	95	345	50

INTEGRATED TOOL CARRIERS — Radial Ply

Model	Tire Size	Strength Index	Pressure											
			Michelin				Goodyear				Bridgestone			
			Front		Rear		Front		Rear		Front		Rear	
		kPa	psi	kPa	psi	kPa	psi	kPa	psi	kPa	psi	kPa	psi	
IT14G	15.5R25	★	275	40	175	25	—	—	—	—	—	—	—	—
	17.5R25	★	225	33	175	25	400	58	300	44	—	—	—	—
IT24F	17.5R25	★	275	40	175	25	400	58	300	44	—	—	—	—
	555/70R25	★	200	29	175	25	—	—	—	—	—	—	—	—
	20.5R25	★	200	29	175	25	400	58	300	44	—	—	—	—
IT28G	17.5R25	★	375	54	200	29	400	58	300	44	—	—	—	—
	555/70R25	★	250	36	175	25	—	—	—	—	—	—	—	—
	20.5R25	★	250	36	175	25	400	58	300	44	—	—	—	—
IT38G	20.5R25	★	310	45	207	30	345	50	241	35	380	55	205	30

Standard Cold Inflation Pressures
Bias and Bias Belted/Radial Ply

Tires

- Underground Mining
- Articulated Trucks
- Rigid Trucks

UNDERGROUND MINING — Bias and Bias Belted

LOAD – HAUL – DUMP			Ply Rating	Bridgestone			
Model	Wheel Size	Tire Size		Front*		Rear*	
R1300	14.0×25	17.5×25	20	kPa 650	psi 94	kPa 410	psi 60
R1600	13.0×25	18.0×25	28	620	90	410	60
R1700 Series II	22.0×25	26.5×25	32	600	87	410	60
R2900	25.0×25	29.5×29	34	650	94	410	60

ARTICULATED TRUCKS

AD40 Series II	25.0×29	29.5×R29	40	620	90	620	90
AE40 Series II	29.5×29	29.5×R29	40	620	90	620	90

RIGID TRUCKS

69D Dump	13.0×33	18.0×R33	36	650	94	650	94
69D Ejector	13.0×33	18.0×R33	40	630	91	630	91
73D	15.0×35	21.0×R35	—	—	—	—	—

*For standard loading applications.

NOTE: When tramming cycles exceed 150 m (500 ft) contact tire supplier.

UNDERGROUND MINING — Radial Ply

LOAD – HAUL – DUMP			Strength Index	Bridgestone			
Model	Wheel Size	Tire Size		Front*		Rear*	
R1300	14.0×25	17.5×25	★ ★	kPa 700	psi 102	kPa 410	psi 60
R1600	13.0×25	18.0×25	★ ★	675	98	410	60
R1700 Series II	22.0×25	26.5×25	★ ★	650	94	410	60
R2900	25.0×25	29.5×29	★ ★	675	98	410	60

ARTICULATED TRUCKS

AD40 Series II	25.0×29	29.5×R29	★ ★	650	94	620	90
AE40 Series II	29.5×29	29.5×R29	★ ★	650	94	650	94

RIGID TRUCKS

69D Dump	13.0×33	18.0×R33	★ ★	700	102	700	102
69D Ejector	13.0×33	18.0×R33	★ ★	700	102	700	102
73D	15.0×35	21.0×R35	★ ★	700	102	700	102

*For standard loading applications.

NOTE: When tramming cycles exceed 150 m (500 ft) contact tire supplier.

BIAS PLY TIRES

RADIAL PLY TIRES

	WEIGHT INCREASE PER TIRE		MIXING PROPORTIONS				WEIGHT INCREASE PER TIRE		MIXING PROPORTIONS			
	kg	lb	CaCl ^{***}		Water		kg	lb	CaCl ^{***}		Water	
			kg	lb	liter	gal			kg	lb	liter	gal
13.00-24TG	188	414	55	122	132	35	185	407	57	125	128	34
14.00-24TG	215	475	63	140	151	40	256	565	79	173	179	47
15.5-25	192	423	56	125	136	36	224	493	69	151	155	41
16.00-24TG	333	735	98	217	234	62	355	783	109	240	246	65
17.5-25	262	577	77	170	185	49	311	686	95	210	216	57
18.00-25	454	1002	134	296	322	85	502	1107	154	340	348	92
18.4-34	417	919	123	272	295	78	—	—	—	—	—	—
20.5-25	405	892	119	263	284	75	448	987	137	303	310	82
23.1-26	522	1151	154	340	367	97	—	—	—	—	—	—
23.5-25	585	1291	173	382	412	109	633	1396	194	428	439	116
24.5-32	703	1549	207	458	496	131	—	—	—	—	—	—
26.5-25	758	1671	224	494	533	141	841	1853	258	568	583	154
26.5-29	752	1658	222	490	530	140	928	2045	284	627	644	170
28L-26	709	1563	209	462	500	132	—	—	—	—	—	—
29.5-25	970	2139	286	632	685	181	1073	2368	328	723	745	197
29.5-29	1050	2315	310	684	738	195	1190	2623	365	804	825	218
29.5-35	1159	2556	344	758	821	217	1286	2835	394	869	892	236
30.5L-32	874	1928	258	570	617	163	—	—	—	—	—	—
33.25-35	1485	3275	439	968	1048	277	1592	3508	487	1074	1105	292
37.25-35	1712	3775	505	1115	1211	320	2128	4692	653	1439	1476	390
38-39	1870	4123	552	1218	1317	348	—	—	—	—	—	—
35/65-33	1339	2953	396	873	942	249	1430	3152	438	967	992	262
40/65-39	2077	4580	614	1353	1465	387	2194	4836	673	1483	1522	402
41.25/70-39	1897	4183	561	1236	1336	353	—	—	—	—	—	—
45/65-45	2548	5617	753	1659	1794	474	—	—	—	—	—	—

*Ballast weight for bias ply tires from Goodyear data, radial ply weights from Michelin data. Contact your tire supplier for additional information. Under abnormal tire wear conditions, ballasting of rear tires may be desirable. Ballasting of front tires also should only be done where extremely rapid tire wear rates are encountered. Excessive weight will reduce machine performance.

**Fillage beyond 75% of tire enclosed volume is not recommended. With liquid ballasting, inflation pressure must be checked at least once per day.

***1.6 kg (3½ lb) Calcium Chloride per gallon water. Solution weighs 4.6 kg (10.15 lb) per gallon.

NOTE: When liquid ballasting telehandler tires, consult Telehandler's Operation and Maintenance Manual for requirements. Also total machine mass with ballasted tires must not exceed certification mass listed on the ROPS certification label.

MINING AND EARTHMOVING

CONTENTS

Elements of production23-1
 Volume measure23-2
 Swell23-2
 Load factor23-2
 Material density23-2
 Fill factor23-3
 Soil density tests23-3
 Figuring production on-the-job23-4
 Load weighing23-4
 Time studies23-4
 English example23-4
 Metric example23-5
 Estimating production off-the-job23-5
 Rolling resistance23-5
 Grade resistance23-6
 Total resistance23-6
 Traction23-6
 Altitude23-7
 Job efficiency23-8
 English example23-8
 Metric example23-10
 Systems23-13
 Fuel consumption and productivity23-14
 Formulas and rules of thumb23-15

INTRODUCTION

This section explains the earthmoving principles used to determine machine productivity. It shows how to calculate production on-the-job or estimate production off-the-job.

Machine performance is usually measured on an hourly basis in terms of machine productivity and machine owning and operating cost. Optimum machine performance can be expressed as follows:

$$\text{Lowest cost per ton} = \frac{\text{Lowest Possible Hourly Costs}}{\text{Highest Possible Hourly Productivity}}$$

ELEMENTS OF PRODUCTION

Production is the hourly rate at which material is moved. Production can be expressed in various units:

Metric

Bank Cubic Meters	— BCM — bank m ³
Loose Cubic Meters	— LCM — loose m ³
Compacted Cubic Meters	— CCM — compacted m ³

Tonnes

English

Bank Cubic Yards	— BCY — bank yd ³
Loose Cubic Yards	— LCY — loose yd ³
Compacted Cubic Yards	— CCY — compacted yd ³

Tons

For most earthmoving and material handling applications, production is calculated by multiplying the quantity of material (load) moved per cycle by the number of cycles per hour.

$$\text{Production} = \text{Load/cycle} \times \text{cycles/hour}$$

The load can be determined by

- 1) load weighing
- 2) load estimating based on machine rating
- 3) surveyed volume divided by load count

Generally, earthmoving and overburden removal for coal mines are calculated by volume (bank cubic meters or bank cubic yards). Metal mines and aggregate producers usually work in weight (tons or tonnes).

- Volume Measure ● Swell
- Load Factor ● Material Density

Volume Measure — Material volume is defined according to its state in the earthmoving process. The three measures of volume are:

- BCM (BCY) — one cubic meter (yard) of material as it lies in the natural bank state.
- LCM (LCY) — one cubic meter (yard) of material which has been disturbed and has swelled as a result of movement.
- CCM (CCY) — one cubic meter (yard) of material which has been compacted and has become more dense as a result of compaction.

In order to estimate production, the relationships between bank measure, loose measure, and compacted measure must be known.

Swell — Swell is the percentage of original volume (cubic meters or cubic yards) that a material increases when it is removed from the natural state. When excavated, the material breaks up into different size particles that do not fit together, causing air pockets or voids to reduce the weight per volume. For example to hold the same weight of one cubic unit of bank material it takes 30% more volume (1.3 times) after excavation. (Swell is 30%.)

$$1 + \text{Swell} = \frac{\text{Loose cubic volume for a given weight}}{\text{Bank cubic volume for the same given weight}}$$

$$\text{Bank} = \frac{\text{Loose}}{(1 + \text{Swell})}$$

$$\text{Loose} = \text{Bank} \times (1 + \text{Swell})$$

Example Problem:

If a material swells 20%, how many loose cubic meters (loose cubic yards) will it take to move 1000 bank cubic meters (1308 bank cubic yards)?

$$\begin{aligned} \text{Loose} &= \text{Bank} \times (1 + \text{Swell}) = \\ &1000 \text{ BCM} \times (1 + .2) = 1200 \text{ LCM} \\ &1308 \text{ BCY} \times (1 + .2) = 1570 \text{ LCY} \end{aligned}$$

How many bank cubic meters (yards) were moved if a total of 1000 loose cubic meters (1308 yards) have been moved? Swell is 25%.

$$\begin{aligned} \text{Bank} &= \text{Loose} \div (1 + \text{Swell}) = \\ &1000 \text{ LCM} \div (1 + .25) = 800 \text{ BCM} \\ &1308 \text{ LCY} \div (1 + .25) = 1046 \text{ BCY} \end{aligned}$$

Load Factor — Assume one bank cubic yard of material weighs 3000 lb. Because of material characteristics, this bank cubic yard swells 30% to 1.3 loose cubic yards when loaded, with no change in weight. If this 1.0 bank cubic yard or 1.3 loose cubic yards is compacted, its volume may be reduced to 0.8 compacted cubic yard, and the weight is still 3000 lbs.

Instead of dividing by 1 + Swell to determine bank volume, the loose volume can be multiplied by the load factor.

If the percent of material swell is known, the load factor (L.F.) may be obtained by using the following relationship:

$$\text{L.F.} = \frac{100\%}{100\% + \% \text{ swell}}$$

Load factors for various materials are listed in the Tables Section of this handbook.

To estimate the machine payload in bank cubic yards, the volume in loose cubic yards is multiplied by the load factor:

$$\text{Load (BCY)} = \text{Load (LCY)} \times \text{L.F.}$$

The ratio between compacted measure and bank measure is called shrinkage factor (S.F.):

$$\text{S.F.} = \frac{\text{Compacted cubic yards (CCY)}}{\text{Bank cubic yards (BCY)}}$$

Shrinkage factor is either estimated or obtained from job plans or specifications which show the conversion from compacted measure to bank measure. Shrinkage factor should not be confused with percentage compaction (used for specifying embankment density, such as Modified Proctor or CBR).

Material Density — Density is the weight per unit volume of a material. Materials have various densities depending on particle size, moisture content and variations in the material. The denser the material the more weight there is per unit of equal volume. Density estimates are provided in the Tables Section of this handbook.

$$\text{Density} = \frac{\text{Weight}}{\text{Volume}} = \frac{\text{kg (lbs)}}{\text{m}^3 (\text{yd}^3)}$$

$$\text{Weight} = \text{Volume} \times \text{Density}$$

A given material's density changes between bank and loose. One cubic unit of loose material has less weight than one cubic unit of bank material due to air pockets and voids. To correct between bank and loose use the following equations.

$$1 + \text{Swell} = \frac{\text{kg/BCM}}{\text{kg/LCM}} \text{ or } \frac{\text{lbs/BCY}}{\text{lbs/LCY}}$$

$$\text{lbs/LCY} = \frac{\text{lb/BCY}}{(1 + \text{Swell})}$$

$$\text{lbs/BCY} = \text{lbs/LCY} \times (1 + \text{Swell})$$

Fill Factor — The percentage of an available volume in a body, bucket, or bowl that is actually used is expressed as the fill factor. A fill factor of 87% for a hauler body means that 13% of the rated volume is not being used to carry material. Buckets often have fill factors over 100%.

Example Problem:

A 14 cubic yard (heaped 2:1) bucket has a 105% fill factor when operating in a shot sandstone (4125 lbs/BCY and a 35% swell).

- What is the loose density of the material?
 - What is the usable volume of the bucket?
 - What is the bucket payload per pass in BCY?
 - What is the bucket payload per pass in tons?
- $\text{lb/LCY} = \text{lb/BCY} \div (1 + \text{Swell}) = 4125 \div (1.35) = 3056 \text{ lb/LCY}$
 - $\text{LCY} = \text{rated LCY} \times \text{fill factor} = 14 \times 1.05 = 14.7 \text{ LCY}$
 - $\text{lbs/pass} = \text{volume} \times \text{density lb/LCY} = 14.7 \times 3056 = 44,923 \text{ lbs}$
 $\text{BCY/pass} = \text{weight} \div \text{density lb/BCY} = 44,923 \div 4125 = 10.9 \text{ BCY}$
 or bucket LCY from part b $\div (1 + \text{Swell}) = 14.7 \div 1.35 = 10.9 \text{ BCY}$
 - $\text{tons/pass} = \text{lbs} \div 2000 \text{ lbs/ton} = 44,923 \div 2000 = 22.5 \text{ tons}$

Example Problem:

Construct a 10,000 compacted cubic yard (CCY) bridge approach of dry clay with a shrinkage factor (S.F.) of 0.80. Haul unit is rated 14 loose cubic yards struck and 20 loose cubic yards heaped.

- How many bank yards are needed?
- How many loads are required?

$$\text{a) BCY} = \frac{\text{CCY}}{\text{S.F.}} = \frac{10,000}{0.80} = 12,500 \text{ BCY}$$

$$\begin{aligned} \text{b) Load (BCY)} &= \text{Capacity (LCY)} \\ &\times \text{Load factor (L.F.)} = 20 \times 0.81 \\ &= 16.2 \text{ BCY/Load} \end{aligned}$$

(L.F. of 0.81 from Tables)

$$\begin{aligned} \text{Number of} \\ \text{loads required} &= \frac{12,500 \text{ BCY}}{16.2 \text{ BCY/Load}} = 772 \text{ Loads} \end{aligned}$$



Soil Density Tests — There are a number of acceptable methods that can be used to determine soil density. Some that are currently in use are:

- Nuclear density moisture gauge
- Sand cone method
- Oil method
- Balloon method
- Cylinder method

All these except the nuclear method use the following procedure:

- Remove a soil sample from bank state.
- Determine the volume of the hole.
- Weigh the soil sample.
- Calculate the density kg/BCM (lb/BCY).

The nuclear density moisture gauge is one of the most modern instruments for measuring soil density and moisture. A common radiation channel emits either neutrons or gamma rays into the soil. In determining soil density, the number of gamma rays absorbed and back scattered by soil particles is *indirectly* proportional to the soil density. When measuring moisture content, the number of moderated neutrons reflected back to the detector after colliding with hydrogen particles in the soil is *directly* proportional to the soil's moisture content.

All these methods are satisfactory and will provide accurate densities when performed correctly. Several repetitions are necessary to obtain an average.

- Load Weighing
- Time Studies
- Example (English)

FIGURING PRODUCTION ON-THE-JOB

Load Weighing — The most accurate method of determining the actual load carried is by weighing. This is normally done by weighing the haul unit one wheel or axle at a time with portable scales. Any scales of adequate capacity and accuracy can be used. While weighing, the machine should be relatively level to reduce error caused by weight transfer. Enough loads should be weighed to provide a good average. Machine weight is the sum of the individual wheel or axle weights.

The weight of the load can be determined using the empty and loaded weight of the unit.

Weight of

$$\text{load} = \text{Gross machine weight} - \text{empty weight}$$

To determine the bank cubic measure carried by a machine, the load weight is divided by the bank-state density of the material being hauled.

$$\text{BCY} = \frac{\text{Weight of load}}{\text{Bank density}}$$

Times Studies — To estimate production, the number of complete trips a unit makes per hour must be determined. First obtain the unit's cycle time with the help of a stop watch. Time several complete cycles to arrive at an average cycle time. By allowing the watch to run continuously, different segments such as load time, wait time, etc. can be recorded for each cycle. Knowing the individual time segments affords a good opportunity to evaluate the balance of the spread and job efficiency. The following is an example of a scraper load time study form. Numbers in the white columns are stop watch readings; numbers in the shaded columns are calculated:

Total Cycle Times (less delays)	Arrive Cut	Wait Time	Begin Load	Load Time	End Load	Begin Delay	Delay Time	End Delay
	0.00	0.30	0.30	0.60	0.90			
3.50	3.50	0.30	3.80	0.65	4.45			
4.00	7.50	0.35	7.85	0.70	8.55	9.95	1.00	10.95
4.00	12.50	0.42	12.92	0.68	13.60			

NOTE: All numbers are in minutes

This may be easily extended to include other segments of the cycle such as haul time, dump time, etc. Similar forms can be made for pushers, loaders, dozers, etc. *Wait Time* is the time a unit must wait for another unit so that the two can function together (haul unit waiting for pusher). *Delay Time* is any time, other than wait time, when a machine is not

performing in the work cycle (scraper waiting to cross railroad track).

To determine trips-per-hour at 100% efficiency, divide 60 minutes by the average cycle time less all wait and delay time. Cycle time may or may not include wait and/or delay time. Therefore, it is possible to figure different kinds of production: measured production, production without wait or delay, maximum production, etc. For example:

Actual Production: includes all wait and delay time.

Normal Production (without delays): includes wait time that is considered normal, but no delay time.

Maximum Production: to figure maximum (or optimum) production, both wait time and delay time are eliminated. The cycle time may be further altered by using an optimum load time.

Example (English)

A job study of a Wheel Tractor-Scraper might yield the following information:

- Average wait time = 0.28 minute
- Average load time = 0.65
- Average delay time = 0.25
- Average haul time = 4.26
- Average dump time = 0.50
- Average return time = 2.09
- Average total cycle = 8.03 minutes
- Less wait & delay time = 0.53
- Average cycle 100% eff. = 7.50 minutes

Weight of haul unit empty — 48,650 lb

Weights of haul unit loaded —

Weighing unit #1 — 93,420 lb

Weighing unit #2 — 89,770 lb

Weighing unit #3 — 88,760 lb

271,950 lb;

average = 90,650 lb

1. Average load weight = 90,650 lb – 48,650 lb = 42,000 lb
2. Bank density = 3125 lb/BCY
3. Load = $\frac{\text{Weight of load}}{\text{Bank density}}$

$$= \frac{42,000 \text{ lb}}{3125 \text{ lb/BCY}} = 13.4 \text{ BCY}$$
4. Cycles/hr = $\frac{60 \text{ min/hr}}{\text{Cycle time}} = \frac{60 \text{ min/hr}}{7.50 \text{ min/cycle}} = 80 \text{ cycles/hr}$
5. Production (less delays) = Load/cycle × cycles/hr

$$= 13.4 \text{ BCY/cycle} \times 8.0 \text{ cycles/hr} = 107.2 \text{ BCY/hr}$$

Example (Metric)

A job study of a Wheel Tractor-Scraper might yield the following information:

Average wait time	= 0.28 minute
Average load time	= 0.65
Average delay time	= 0.25
Average haul time	= 4.26
Average dump time	= 0.50
Average return time	= 2.09
Average total cycle	= 8.03 minutes
Less wait & delay time	= 0.53
Average cycle 100% eff.	= 7.50 minutes

Weight of haul unit empty — 22 070 kg

Weights of haul unit loaded —

Weighing unit #1	— 42 375 kg
Weighing unit #2	— 40 720 kg
Weighing unit #3	— 40 260 kg

123 355 kg;
 average = 41 120 kg

1. Average load weight = 41 120 kg – 22 070 kg = 19 050 kg
2. Bank density = 1854 kg/BCM
3. Load = $\frac{\text{Weight of load}}{\text{Bank density}}$
 $= \frac{19\ 050\ \text{kg}}{1854\ \text{kg/BCM}} = 10.3\ \text{BCM}$
4. Cycles/hr = $\frac{60\ \text{min/hr}}{\text{Cycle time}} = \frac{60\ \text{min/hr}}{7.50\ \text{min/cycle}} = 80\ \text{cycles/hr}$
5. Production = Load/cycle × cycles/hr
 (less delays) = 10.3 BCM/cycle × 8.0 cycles/hr
 = 82 BCM/hr



ESTIMATING PRODUCTION OFF-THE-JOB

It is often necessary to estimate production of earthmoving machines which will be selected for a job. As a guide, the remainder of the section is devoted to discussions of various factors that may affect production. Some of the figures have been rounded for easier calculation.

Rolling Resistance (RR) is a measure of the force that must be overcome to roll or pull a wheel over the ground. It is affected by ground conditions and load — the deeper a wheel sinks into the ground, the higher the rolling resistance. Internal friction and tire flexing also contribute to rolling resistance. Experience has shown that minimum resistance is approximately 2% (1.5% for radial tires or dual tired trucks) of the gross machine weight (on tires). Resistance due to tire penetration is approximately 1.5% of the gross machine weight for each inch of tire penetration (0.6% for each cm of tire penetration). Thus rolling resistance can be calculated using these relationships in the following manner:

$$\text{RR} = 2\% \text{ of GMW} + 0.6\% \text{ of GMW per cm tire penetration}$$

$$\text{RR} = 2\% \text{ of GMW} + 1.5\% \text{ of GMW per inch tire penetration}$$

It's *not* necessary for the tires to actually penetrate the road surface for rolling resistance to increase above the minimum. If the road surface flexes under load, the effect is nearly the same — the tire is always running “uphill”. Only on very hard, smooth surfaces with a well compacted base will the rolling resistance approach the minimum.

When actual penetration takes place, some variation in rolling resistance can be noted with various inflation pressures and tread patterns.

NOTE: When figuring “pull” requirements for track-type tractors, rolling resistance applies only to the trailed unit's *weight on wheels*. Since tracktype tractors utilize steel wheels moving on steel “roads”, a tractor's rolling resistance is relatively constant and is accounted for in the Drawbar Pull rating.

- Grade Resistance
- Total Resistance
- Traction

Grade Resistance is a measure of the force that must be overcome to move a machine over unfavorable grades (uphill). Grade assistance is a measure of the force that assists machine movement on favorable grades (downhill).

Grades are generally measured in percent slope, which is the ratio between vertical rise or fall and the horizontal distance in which the rise or fall occurs. For example, a 1% grade is equivalent to a 1 m (ft) rise or fall for every 100 m (ft) of horizontal distance; a rise of 4.6 m (15 ft) in 53.5 m (175 ft) equals an 8.6% grade.

$$\frac{4.6 \text{ m (rise)}}{53.3 \text{ m (horizontal distance)}} = 8.6\% \text{ grade}$$

$$\frac{15 \text{ ft (rise)}}{175 \text{ ft (horizontal distance)}} = 8.6\% \text{ grade}$$

Uphill grades are normally referred to as adverse grades and downhill grades as favorable grades. Grade resistance is usually expressed as a positive (+) percentage and grade assistance is expressed as a negative (-) percentage.

It has been found that for each 1% increment of adverse grade an additional 10 kg (20 lb) of resistance must be overcome for each metric (U.S.) ton of machine weight. This relationship is the basis for determining the Grade Resistance Factor which is expressed in kg/metric ton (lb/U.S. ton):

$$\text{Grade Resistance Factor} = 10 \text{ kg/m ton} \times \% \text{ grade} \\ = 20 \text{ lb/U.S. ton} \times \% \text{ grade}$$

Grade resistance (assistance) is then obtained by multiplying the Grade Resistance Factor by the machine weight (GMW) in metric (U.S.) tons.

$$\text{Grade Resistance} = \text{GR Factor} \times \text{GMW in metric (U.S.) tons}$$

Grade resistance may also be calculated using percentage of gross weight. This method is based on the relationship that grade resistance is approximately equal to 1% of the gross machine weight for 1% of grade.

$$\text{Grade Resistance} = 1\% \text{ of GMW} \times \% \text{ grade}$$

Grade resistance (assistance) affects both wheel and track-type machines.

Total Resistance is the combined effect of rolling resistance (wheel vehicles) and grade resistance. It can be computed by summing the values of rolling resistance and grade resistance to give a resistance in kilogram (pounds) force.

$$\text{Total Resistance} = \text{Rolling Resistance} + \text{Grade Resistance}$$

Total resistance can also be represented as consisting completely of grade resistance expressed in percent grade. In other words, the rolling resistance component is viewed as a corresponding quantity of additional adverse grade resistance. Using this approach, total resistance can then be considered in terms of percent grade.

This can be done by converting the contribution of rolling resistance into a corresponding percentage of grade resistance. Since 1% of adverse grade offers a resistance of 10 kg (20 lb) for each metric or (U.S.) ton of machine weight, then each 10 kg (20 lb) of resistance per ton of machine weight can be represented as an additional 1% of adverse grade. Rolling resistance in percent grade and grade resistance in percent grade can then be summed to give Total Resistance in percent or Effective Grade. The following formulas are useful in arriving at Effective Grade.

$$\text{Rolling Resistance (\%)} = 2\% + 0.6\% \text{ per cm tire penetration} \\ = 2\% + 1.5\% \text{ per inch tire penetration}$$

$$\text{Grade Resistance (\%)} = \% \text{ grade} \\ \text{Effective Grade (\%)} = \text{RR (\%)} + \text{GR (\%)}$$

Effective grade is a useful concept when working with Rimpull-Speed-Gradeability curves, Retarder curves, Brake Performance curves, and Travel Time curves.

Traction — is the driving force developed by a wheel or track as it acts upon a surface. It is expressed as usable Drawbar Pull or Rimpull. The following factors affect traction: weight on the driving wheel or tracks, gripping action of the wheel or track, and ground conditions. The coefficient of traction (for any roadway) is the ratio of the maximum pull developed by the machine to the total weight on the drivers.

$$\text{Coeff. of traction} = \frac{\text{Pull}}{\text{weight on drivers}}$$

Therefore, to find the usable pull for a given machine:

$$\text{Usable pull} = \text{Coeff. of traction} \times \text{weight on drivers}$$

Example: Track-Type Tractor

What usable drawbar pull (DBP) can a 26 800 kg (59,100 lb) Track-type Tractor exert while working on firm earth? on loose earth? (See table section for coefficient of traction.)

Answer:
 Firm earth — Usable DBP =
 $0.90 \times 26\,800 \text{ kg} = 24\,120 \text{ kg}$
 $(0.90 \times 59,100 \text{ lb} = 53,190 \text{ lb})$
 Loose earth — Usable DBP =
 $0.60 \times 26\,800 \text{ kg} = 16\,080 \text{ kg}$
 $(0.60 \times 59,100 \text{ lb} = 35,460 \text{ lb})$

If a load required 21 800 kg (48,000 lb) pull to move it, this tractor could move the load on firm earth. However, if the earth were loose, the tracks would spin.

NOTE: D8R through D11R Tractors may attain higher coefficients of traction due to their suspended undercarriage.

Example: Wheel Tractor-Scraper

What usable rimpull can a 621F size machine exert while working on firm earth? on loose earth? The total loaded weight distribution of this unit is:

Drive unit	Scraper unit
wheels: 23 600 kg	wheels: 21 800 kg
(52,000 lb)	(48,000 lb)

Remember, use weight on drivers only.

Answer:
 Firm earth — $0.55 \times 23\,600 \text{ kg} = 12\,980 \text{ kg}$
 $(0.55 \times 52,000 \text{ lb} = 28,600 \text{ lb})$
 Loose earth — $0.45 \times 23\,600 \text{ kg} = 10\,620 \text{ kg}$
 $(0.45 \times 52,000 \text{ lb} = 23,400 \text{ lb})$

On firm earth this unit can exert up to 12 980 kg (28,600 lb) rimpull without excessive slipping. However, on loose earth the drivers would slip if more than 10 620 kg (23,400 lb) rimpull were developed.



Altitude — Specification sheets show how much pull a machine can produce for a given gear and speed when the engine is operating at rated horsepower. When a standard machine is operated in high altitudes, the engine may require derating to maintain normal engine life. This engine deration will produce less drawbar pull or rimpull.

The Tables Section gives the altitude deration in percent of flywheel horsepower for current machines. It should be noted that some turbocharged engines can operate up to 3050 m (10,000 ft) before they require derating. Most machines are engineered to operate up to 1520 m (5000 ft) before they require deration.

The horsepower deration due to altitude must be considered in any job estimating. The amount of power deration will be reflected in the machine's gradeability and in the load, travel, and dump and load times (unless loading is independent of the machine itself).

The example job problem that follows indicates one method of accounting for altitude deration: by increasing the appropriate components of the total cycle time by a percentage equal to the percent of horsepower deration due to altitude. (i.e., if the travel time of a hauling unit is determined to be 1.00 minute at full HP, the time for the same machine derated to 90% of full HP will be 1.10 min.) This is an approximate method that yields reasonably accurate estimates up to 3000 m (10,000 feet) elevation.

Travel time for hauling units derated more than 10% should be calculated as follows using Rimpull-Speed-Gradeability charts.

- 1) Determine total resistance (grade plus rolling) in percent.

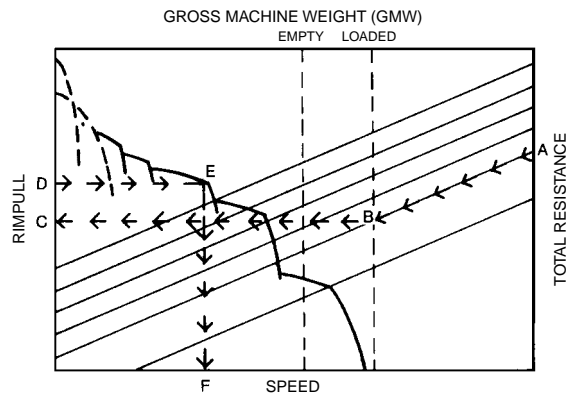

- 2) Beginning at point A on the chart follow the total resistance line diagonally to its intersection, B, with the vertical line corresponding to the appropriate gross machine weight. (Rated loaded and empty GMW lines are shown dotted.)

- 3) Using a straight-edge, establish a horizontal line to the left from point B to point C on the rimpull scale.

- 4) Divide the value of point C as read on the rimpull scale by the percent of total horsepower available after altitude deration from the Tables Section. This yields rimpull value D higher than point C.

- Job Efficiency
- Example Problem (English)

5) Establish a horizontal line right from point D. The farthest right intersection of this line with a curved speed range line is point E.

6) A vertical line down from point E determines point F on the speed scale.

7) Multiply speed in kmh by 16.7 (mph by 88) to obtain speed in m/min (ft/min). Travel time in minutes for a given distance in feet is determined by the formula:

$$\text{Time (min)} = \frac{\text{Distance in m (ft)}}{\text{Speed in m/min (ft/min)}}$$

The *Travel Time Graphs* in sections on Wheel Tractor-Scrapers and Construction & Mining Trucks can be used as an alternative method of calculating haul and/or return times.

Job Efficiency is one of the most complex elements of estimating production since it is influenced by factors such as operator skill, minor repairs and adjustments, personnel delays, and delays caused by job layout. An approximation of efficiency, if no job data is available, is given below.

Operation	Working Hour	Efficiency Factor
Day	50 min/hr	0.83
Night	45 min/hr	0.75

These factors do not account for delays due to weather or machine downtime for maintenance and repairs. You must account for such factors based on experience and local conditions.



Example problem (English)

A contractor is planning to put the following spread on a dam job. What is the estimated production and cost/BCY?

Equipment:

- 11 — 631E Series II Wheel Tractor-Scrapers
- 2 — D9N Tractors with C-dozers
- 2 — 12G Motor Graders
- 1 — 825C Tamping Foot Compactor

Material:

- Description — Sandy clay; damp, natural bed
- Bank Density — 3000 lb/BCY
- Load Factor — 0.80
- Shrinkage Factor — 0.85
- Traction Factor — 0.50
- Altitude — 7500 ft

Job Layout — Haul and Return:

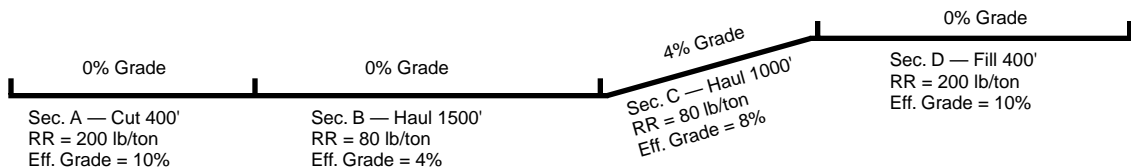

1. Estimate Payload:

Est. load (LCY) × L.F. × Bank Density = payload
 31 LCY × 0.80 × 3000 lb/BCY = 74,400 lb payload

2. Establish Machine Weight:

- Empty Wt. — 88,000 lb or 44 tons
- Wt. of Load — 74,400 lb or 37.2 tons
- Total (GMW) — 162,400 lb or 81.2 tons

3. Calculate Usable Pull (traction limitation):

Loaded: (weight on driving wheels = 54%) (GMW)

Traction Factor × Wt. on driving wheels =
 0.50 × 162,400 lb × 54% = 43,848 lbs

Empty: (weight on driving wheels = 69%) (GMW)

Traction Factor × Wt. on driving wheels =
 0.50 × 88,000 lbs × 69% = 30,360 lbs

4. Derate for Altitude:

Check power available at 7500 ft from altitude deration table in the Tables Section.

- 631E Series II — 100%
- D9N — 100%
- 12G — 85%
- 825C — 94%

- Total Effective Grade = RR (%) ± GR (%)**
- Sec. A:** Total Effective Grade = 10% + 0% = 10%
 - Sec. B:** Total Effective Grade = 4% + 0% = 4%
 - Sec. C:** Total Effective Grade = 4% + 4% = 8%
 - Sec. D:** Total Effective Grade = 10% + 0% = 10%

Then adjust if necessary:

Load Time — controlled by D9N, at 100% power, no change.

Travel, Maneuver and Spread time — 631E Series II, no change.

5. Compare Total Resistance to Tractive Effort on haul:

Grade Resistance —

$$\begin{aligned} \text{GR} &= \text{lb/ton} \times \text{tons} \times \text{adverse grade in percent} \\ \text{Sec. C:} &= 20 \text{ lb/ton} \times 81.2 \text{ tons} \times 4\% \text{ grade} = \\ &6496 \text{ lb} \end{aligned}$$

Rolling Resistance —

$$\begin{aligned} \text{RR} &= \text{RR Factor (lb/ton)} \times \text{GMW (tons)} \\ \text{Sec. A:} &= 200 \text{ lb/ton} \times 81.2 \text{ tons} = 16,240 \text{ lb} \\ \text{Sec. B:} &= 80 \text{ lb/ton} \times 81.2 \text{ tons} = 6,496 \text{ lb} \\ \text{Sec. C:} &= 80 \text{ lb/ton} \times 81.2 \text{ tons} = 6,496 \text{ lb} \\ \text{Sec. D:} &= 200 \text{ lb/ton} \times 81.2 \text{ tons} = 16,240 \text{ lb} \end{aligned}$$

Total Resistance —

$$\begin{aligned} \text{TR} &= \text{RR} + \text{GR} \\ \text{Sec. A:} &= 16,240 \text{ lb} + 0 = 16,240 \text{ lb} \\ \text{Sec. B:} &= 6,496 \text{ lb} + 0 = 6,496 \text{ lb} \\ \text{Sec. C:} &= 6,496 \text{ lb} + 6,496 \text{ lb} = 12,992 \text{ lb} \\ \text{Sec. D:} &= 16,240 \text{ lb} + 0 = 16,240 \text{ lb} \end{aligned}$$

Check usable pounds pull against maximum pounds pull required to move the 631E.

Pull usable ... 43,848 lb loaded

Pull required ... 16,240 lb maximum total resistance

Estimate travel time for haul from 631E (loaded) travel time curve; read travel time from distance and effective grade.

Travel time (from curves):

$$\begin{aligned} \text{Sec. A:} &0.60 \text{ min} \\ \text{Sec. B:} &1.00 \\ \text{Sec. C:} &1.20 \\ \text{Sec. D:} &0.60 \\ &\hline &3.40 \text{ min} \end{aligned}$$

NOTE: This is an estimate only; it *does not account for all the acceleration and deceleration time*, therefore it is not as accurate as the information obtained from a computer program.

6. Compare Total Resistance to Tractive Effort on return:

Grade Assistance —

$$\begin{aligned} \text{GA} &= 20 \text{ lb/ton} \times \text{tons} \times \text{negative grade in percent} \\ \text{Sec. C:} &= 20 \text{ lb/ton} \times 44 \text{ tons} \times 4\% \text{ grade} = \\ &3520 \text{ lbs} \end{aligned}$$

Rolling Resistance —

$$\begin{aligned} \text{RR} &= \text{RR Factor} \times \text{Empty Wt (tons)} \\ \text{Sec. D:} &= 200 \text{ lb/ton} \times 44 \text{ tons} = 8800 \text{ lb} \\ \text{Sec. C:} &= 80 \text{ lb/ton} \times 44 \text{ tons} = 3520 \text{ lb} \\ \text{Sec. B:} &= 80 \text{ lb/ton} \times 44 \text{ tons} = 3520 \text{ lb} \\ \text{Sec. A:} &= 200 \text{ lb/ton} \times 44 \text{ tons} = 8800 \text{ lb} \end{aligned}$$

Total Resistance —

$$\begin{aligned} \text{TR} &= \text{RR} - \text{GA} \\ \text{Sec. D:} &= 8,800 \text{ lb} - 0 = 8,800 \text{ lb} \\ \text{Sec. C:} &= 3,520 \text{ lb} - 3,520 \text{ lb} = 0 \\ \text{Sec. B:} &= 3,520 \text{ lb} - 0 = 3,520 \text{ lb} \\ \text{Sec. A:} &= 8,800 \text{ lb} - 0 = 8,800 \text{ lb} \end{aligned}$$

Check usable pounds pull against maximum pounds pull required to move the 631E.

Pounds pull usable ... 30,360 lb empty

Pounds pull required ... 8800 lb

Estimate travel time for return from 631E empty travel time curve.

Travel time (from curves):

$$\begin{aligned} \text{Sec. D:} &0.40 \text{ min} \\ \text{Sec. C:} &0.55 \\ \text{Sec. B:} &0.80 \\ \text{Sec. A:} &0.40 \\ &\hline &2.15 \text{ min} \end{aligned}$$

7. Estimate Cycle Time:

$$\text{Total Travel Time (Haul plus Return)} = 5.55 \text{ min}$$

$$\text{Adjusted for altitude: } 100\% \times 5.55 \text{ min} = 5.55 \text{ min}$$

$$\text{Load Time} \quad \quad \quad 0.7 \text{ min}$$

$$\text{Maneuver and Spread Time} \quad \quad \quad 0.7 \text{ min}$$

$$\text{Total Cycle Time} \quad \quad \quad \underline{6.95 \text{ min}}$$

8. Check pusher-scraper combinations:

Pusher cycle time consists of load, boost, return and maneuver time. Where actual job data is not available, the following may be used.

$$\text{Boost time} = 0.10 \text{ minute}$$

$$\text{Return time} = 40\% \text{ of load time}$$

$$\text{Maneuver time} = 0.15 \text{ minute}$$

$$\text{Pusher cycle time} = 140\% \text{ of load time} + 0.25 \text{ minute}$$

$$\begin{aligned} \text{Pusher cycle time} &= 140\% \text{ of } 0.7 \text{ min} + 0.25 \text{ minute} \\ &= 0.98 + 0.25 = 1.23 \text{ minute} \end{aligned}$$

Scraper cycle time divided by pusher cycle time indicates the number of scrapers which can be handled by each pusher.

$$\frac{6.95 \text{ min}}{1.23 \text{ min}} = 5.65$$

- Example Problem (English)
- Example Problem (Metric)

Each push tractor is capable of handling five plus scrapers. Therefore the two pushers can adequately serve the eleven scrapers.

9. Estimate Production:

$$\begin{aligned} \text{Cycles/hour} &= 60 \text{ min} \div \text{Total cycle time} \\ &= 60 \text{ min/hr} \div 6.95 \text{ min/cycle} \\ &= 8.6 \text{ cycles/hr} \end{aligned}$$

$$\begin{aligned} \text{Estimated load} &= \text{Heaped capacity} \times \text{L.F.} \\ &= 31 \text{ LCY} \times 0.80 \\ &= 24.8 \text{ BCY} \end{aligned}$$

$$\begin{aligned} \text{Hourly unit production} &= \text{Est. load} \times \text{cycles/hr} \\ &= 24.8 \text{ BCY} \times 8.6 \text{ cycles/hr} \\ &= 213 \text{ BCY/hr} \end{aligned}$$

$$\begin{aligned} \text{Adjusted production} &= \text{Efficiency factor} \times \text{hourly production} \\ &= 0.83 \text{ (50 min hour)} \times 213 \text{ BCY} \\ &= 177 \text{ BCY/hr} \end{aligned}$$

$$\begin{aligned} \text{Hourly fleet production} &= \text{Unit production} \times \text{No. of units} \\ &= 177 \text{ BCY/hr} \times 11 \\ &= 1947 \text{ BCY/hr} \end{aligned}$$

10. Estimate Compaction:

$$\begin{aligned} \text{Compaction requirement} &= \text{S.F.} \times \text{hourly fleet production} \\ &= 0.85 \times 1947 \text{ BCY/hr} \\ &= 1655 \text{ CCY/hr} \end{aligned}$$

Compaction capability (given the following):

Compacting width, 7.4 ft	(W)
Average compacting speed, 6 mph	(S)
Compacted lift thickness, 7 in	(L)
No. of passes required, 3	(P)

$$\begin{aligned} \text{825C production} &= \\ \text{CCY/hr} &= \frac{W \times S \times L \times 16.3}{P} \text{ (conversion constant)} \\ &= \frac{7.4 \times 6 \times 7 \times 16.3}{3} \\ &= 1688 \text{ CCY/hr} \end{aligned}$$

Given the compaction requirement of 1655 CCY/hr, the 825C is an adequate compactor match-up for the rest of the fleet. However, any change to job layout that would increase fleet production would upset this balance.

11. Estimate Total Hourly Cost:

631E	@ \$65.00/hr × 11 units	\$715.00
D9N	@ 75.00/hr × 2 units	150.00
12G	@ 15.00/hr × 2 units	30.00
825C	@ 40.00/hr × 1 unit	40.00
Operators	@ 20.00/hr × 16 men	<u>320.00</u>

Total Hourly Owning and Operating Cost \$1,255.00

12. Calculate Performance:

$$\begin{aligned} \text{Cost per BCY} &= \frac{\text{Total cost/hr}}{\text{Production/hr}} \\ &= \frac{\$1,255.00}{1947 \text{ BCY/hr}} \\ &= 64¢ \text{ BCY} \end{aligned}$$

NOTE: Ton-MPH calculations should be made to judge the ability of the tractor-scraper tires to operate safely under these conditions.

13. Other Considerations:

If other equipment such as rippers, water wagons, discs or other miscellaneous machines are needed for the particular operation, then these machines must also be included in the cost per BCY.



Example problem (Metric)

A contractor is planning to put the following spread on a dam job. What is the estimated production and cost/BCM?

Equipment:

- 11 — 631E Wheel Tractor-Scrapers
- 2 — D9N Tractors with C-dozers
- 2 — 12G Motor Graders
- 1 — 825C Tamping Foot Compactor

Material:

- Description — Sandy clay; damp, natural bed
- Bank Density — 1770 kg/BCM
- Load Factor — 0.80
- Shrinkage Factor — 0.85
- Traction Factor — 0.50
- Altitude — 2300 meters

Job Layout — Haul and Return:

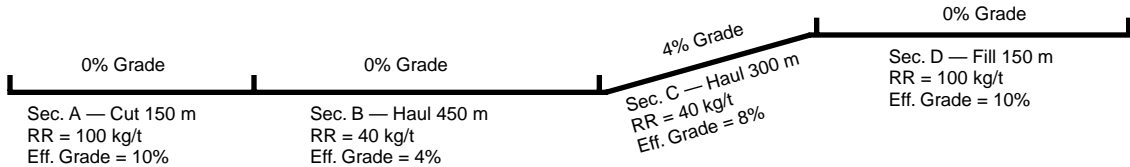

Total Effective Grade = RR (%) ± GR (%)

Sec. A: Total Effective Grade = 10% + 0% = 10%

Sec. B: Total Effective Grade = 4% + 0% = 4%

Sec. C: Total Effective Grade = 4% + 4% = 8%

Sec. D: Total Effective Grade = 10% + 0% = 10%

1. Estimate Payload:

Est. load (LCM) × L.F. × Bank Density = payload
 24 LCM × 0.80 × 1770 kg/BCM = 34 000 kg payload

2. Machine Weight:

Empty Wt. — 40 000 kg or 40 metric tons

Wt. of Load — 34 000 kg or 34 metric tons

Total (GMW) — 74 000 kg or 74 metric tons

3. Calculate Usable Pull (traction limitation):

Loaded: (weight on driving wheels = 54%) (GMW)

Traction Factor × Wt. on driving wheels =
 0.50 × 74 000 kg × 54% = 19 980 kg

Empty: (weight on driving wheels = 69%) (GMW)

Traction Factor × Wt. on driving wheels =
 0.50 × 40 000 kg × 69% = 13 800 kg

4. Derate for Altitude:

Check power available at 2300 m from altitude deration table in the Tables Section.

631E — 100% 12G — 85%

D9N — 100% 825C — 94%

Then adjust if necessary:

Load Time — controlled by D9N, at 100% power, no change.

Travel, Maneuver and Spread time — 631E, no change.

5. Compare Total Resistance to Tractive Effort on haul:

Grade Resistance —

GR = 10 kg/metric ton × tons × adverse grade in percent

Sec. C: = 10 kg/metric ton × 74 metric tons × 4% grade = 2960 kg

Rolling Resistance —

RR = RR Factor (kg/mton) × GMW (metric tons)

Sec. A: = 100 kg/metric ton × 74 metric tons = 7400 kg

Sec. B: = 40 kg/metric ton × 74 metric tons = 2960 kg

Sec. C: = 40 kg/metric ton × 74 metric tons = 2960 kg

Sec. D: = 100 kg/metric ton × 74 metric tons = 7400 kg

Total Resistance —

TR = RR + GR

Sec. A: = 7400 kg + 0 = 7400 kg

Sec. B: = 2960 kg + 0 = 2960 kg

Sec. C: = 2960 kg + 2960 kg = 5920 kg

Sec. D: = 7400 kg + 0 = 7400 kg

Check usable kilogram force against maximum kilogram force required to move the 631E.

Force usable ... 19 980 kg loaded

Force required ... 7400 kg maximum total resistance

Estimate travel time for haul from 631E (loaded) travel time curve; read travel time from distance and effective grade.

Travel time (from curves):

Sec. A: 0.60 min

Sec. B: 1.00

Sec. C: 1.20

Sec. D: 0.60

3.40 min

NOTE: This is an estimate only; it does not account for all the acceleration and deceleration time, therefore it is not as accurate as the information obtained from a computer program.

6. Compare Total Resistance to Tractive Effort on return:

Grade Assistance —

GA = 10 kg/mton × metric tons × negative grade in percent

Sec. C: = 10 kg/metric ton × 40 metric ton × 4% grade = 1600 kg

Rolling Resistance —

$$RR = RR \text{ Factor} \times \text{Empty Wt.}$$

Sec. D: = 100 kg/metric ton \times 40 metric tons
 = 4000 kg

Sec. C: = 40 kg/metric ton \times 40 metric tons
 = 1600 kg

Sec. B: = 40 kg/metric ton \times 40 metric tons
 = 1600 kg

Sec. A: = 100 kg/metric ton \times 40 metric tons
 = 4000 kg

Total Resistance —

$$TR = RR - GA$$

Sec. D: = 4000 kg - 0 = 4000 kg
 Sec. C: = 1600 kg - 0 = 1600 kg
 Sec. B: = 1600 kg - 0 = 1600 kg
 Sec. A: = 4000 kg - 0 = 4000 kg

Check usable kilogram force against maximum force required to move the 631E.
 Kilogram force usable ... 13 800 kg empty
 Kilogram force required ... 4000 kg
 Estimate travel time for return from 631E empty travel time curve.

Travel time (from curves):

Sec. D: 0.40 min
 Sec. C: 0.55
 Sec. B: 0.80
 Sec. A: 0.40

2.15 min

7. Estimate Cycle Time:

Total Travel Time (Haul plus Return) = 5.55 min
 Adjusted for altitude: 100% \times 5.55 min = 5.55 min
 Load Time 0.7 min
 Maneuver and Spread Time 0.7 min

Total Cycle Time 6.95 min

8. Check pusher-scraper combinations:

Pusher cycle time consists of load, boost, return and maneuver time. Where actual job data is not available, the following may be used.

Boost time = 0.10 minute
 Return time = 40% of load time
 Maneuver time = 0.15 minute
 Pusher cycle time = 140% of load time + 0.25 minute

Pusher cycle time = 140% of 0.7 min + 0.25 minute
 = 0.98 + 0.25 = 1.23 minute

Scraper cycle time divided by pusher cycle time indicates the number of scrapers which can be handled by each pusher.

$$\frac{6.95 \text{ min}}{1.23 \text{ min}} = 5.65$$

Each push tractor is capable of handling five plus scrapers. Therefore the two pushers can adequately serve the eleven scrapers.

9. Estimate Production:

Cycles/hour = 60 min \div Total cycle time
 = 60 min/hr \div 6.95 min/cycle
 = 8.6 cycles/hr

Estimated load = Heaped capacity \times L.F.
 = 24 LCM \times 0.80
 = 19.2 BCM

Hourly unit production = Est. load \times cycles/hr
 = 19.2 BCM \times 8.6 cycles/hr
 = 165 BCM

Adjusted production = Efficiency factor \times hourly production
 = 0.83 (50 min hour) \times 165 BCM
 = 137 BCM/hour

Hourly fleet production = Unit production \times No. of units
 = 137 BCM/hr \times 11 units
 = 1507 BCM/hr

10. Estimate Compaction:

Compaction requirement = S.F. \times hourly fleet production
 = 0.85 \times 1507 BCM/hr
 = 1280 CCM/hr

Compaction capability (given the following):

- Compacting width, 2.26 m (W)
- Average compacting speed, 9.6 km/h (S)
- Compacted lift thickness, 18 cm (L)
- No. of passes required, 3 (P)

825C production =

$$CCM/hr = \frac{W \times S \times L \times 10}{P} \text{ (conversion factor)}$$

$$= \frac{2.26 \times 9.6 \times 18 \times 10}{3}$$

= 1302

Given the compaction requirement of 1280 CCM/h, the 825C is an adequate compactor match-up for the rest of the fleet. However, any change to job layout that would increase fleet production would upset this balance.

11. Estimate Total Hourly Cost:

631E	@ \$65.00/hr × 11 units	\$715.00
D9N	@ 75.00/hr × 2 units	150.00
12G	@ 15.00/hr × 2 units	30.00
825C	@ 40.00/hr × 1 unit	40.00
Operators	@ 20.00/hr × 16 men	320.00

Total Hourly Owning and Operating Cost \$1,255.00

12. Calculate Performance:

$$\begin{aligned}
 \text{Cost per BCM} &= \frac{\text{Total cost/hr}}{\text{Production/hr}} \\
 &= \frac{\$1,255.00}{1507 \text{ BCM/hr}} \\
 &= 83¢/\text{BCM}
 \end{aligned}$$

NOTE: Ton-km/h calculations should be made to judge the ability of the tractor-scraper tires to operate safely under these conditions.

13. Other Considerations:

If other equipment such as rippers, water wagons, discs or other miscellaneous machines are needed for the particular operation, then these machines must also be included in the cost per BCM.

SYSTEMS

Caterpillar offers a variety of machines for different applications and jobs. Many of these separate machines function together in mining and earthmoving systems.

- Bulldozing with track-type tractors
- Load-and-Carry with wheel loaders
- Scrapers self-loading with elevator, auger, or push-pull configurations, or push-loaded by track-type tractors
- Articulated trucks loaded by excavators, track loaders or wheel loaders
- Off-highway trucks loaded by shovels, excavators or wheel loaders

Economic Haul Distances — Mobile equipment systems for construction or mining jobs operate in generalized economic application zones. These zones vary by machine with distance, underfoot conditions, grades, material type, production rate and operator skill. Of these factors, distance provides the best initial basis for system selection. The following table provides general rules of thumb for systems application based on distance. These haul ranges will vary by application.



GENERAL HAUL DISTANCES FOR MOBILE SYSTEMS

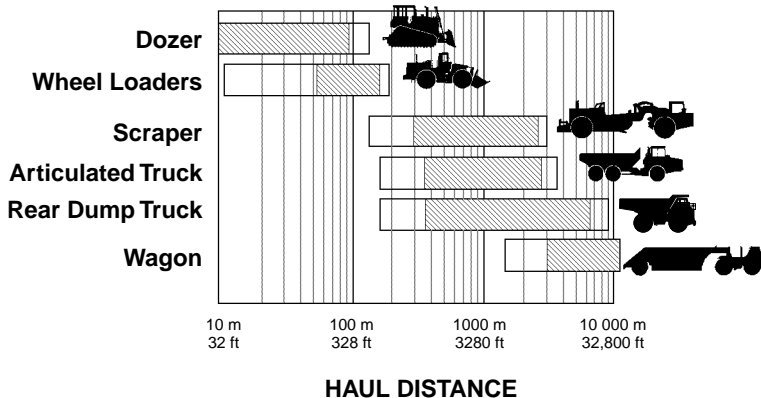

- Loading Match
- Fuel Consumption

Loading Match — Loading tools have a production range that varies with material, bucket configuration, target size, operator skill and load area conditions. The loader/truck matches given in the following table are with the typical number of passes and production range.

Your Cat Dealer can provide advice and estimates based on your specific conditions.

Caterpillar Earthmoving and Mining Systems Production/50 Min. Hr.

Tonnes	Tons	Loading Tool	Passes	Target
2270/2450	2500/2700	994 HL	7	793C
2450/2700	2700/3000	994	5	789C
2270/2450	2500/2700	994 HL	6	789C
2450/2700	2700/3000	994	4	785C
1450/1600	1600/1800	992G	6	785C
1540/1720	1700/1900	992G	4	777D
1180/1360	1300/1500	990	3	773D
730/910	800/1000	988F	3	769D
2720/2900	3000/3200	5230 ME	7	793C
2540/2720	2800/3000	5230 FS	8	793C
2630/2810	2900/3100	5230 ME	6	789C
2450/2630	2700/2900	5230 FS	6	789C
2540/2720	2800/3000	5230 ME	5	785C
2360/2540	2600/2800	5230 FS	5	785C
1900/2100	2100/2300	5130B ME	7	785C
1700/1900	1700/2100	5130B FS	7	785C
1800/2000	2000/2200	5130B ME	5	777D
1540/1810	1700/2000	5130B FS	5	777D
910/1090	1000/1200	375 ME	7	773D
730/820	800/1000	5080 FS	7	773D
730/910	800/1000	375 ME	5	769D
630/820	700/900	5080 FS	5	769D

FUEL CONSUMPTION AND PRODUCTIVITY

Fuel efficiency is the term used to relate fuel consumption and machine productivity. It is expressed in units of material moved per volume of fuel consumed. Common units are cubic meters or tonnes per liter of fuel (cubic yards or tons/gal). Determining fuel efficiency requires measuring both fuel consumption and production.

Measuring fuel consumption involves tapping into the vehicle's fuel supply system — without contaminating the fuel. The amount of fuel consumed during operation is then measured on a weight or volumetric basis.

Caterpillar Aggregate Systems Production/50 Min. Hr.

Tonnes	Tons	Loading Tool	Passes	Target
1540/1720	1700/1900	992G	4	777D
1450/1630	1600/1800	992G	3	775D
1090/1270	1200/1400	990	4	775D
910/1180	1000/1300	990	3	773D
630/900	700/900	988F HL	5	773D
730/910	800/1000	988F	4	771D
540/730	600/800	980F HL	6	771D
630/820	700/900	988F	3	769D
450/630	500/700	980F HL	5	769D
1500/1800	1700/2000	5130B FS	5	777D
1270/1450	1400/1600	5130B FS	4	775D
1180/1360	1300/1500	5130B FS	3	773D
630/900	700/900	5080 FS	7	773D
730/910	800/1000	5080 FS	5	771D
630/820	700/900	5080 FS	4	769D

FORMULAS AND RULES OF THUMB

Production, hourly = Load (BCM) cycle × cycles/hr
 = Load (BCY) cycle × cycles/hr

Load Factor (L.F.) = $\frac{100\%}{100\% + \% \text{ swell}}$

Load (bank measure) = Loose cubic meters (LCM) × L.F.
 = Loose cubic yards (LCY) × L.F.
 = $\frac{\text{Compacted cubic meters (or yards)}}{\text{Bank cubic meters (or yards)}}$

Shrinkage Factor (S.F.) = $\frac{\text{Compacted cubic meters (or yards)}}{\text{Bank cubic meters (or yards)}}$

Density = Weight/Unit Volume

Load (bank measure) = $\frac{\text{Weight of load}}{\text{Bank density}}$

Rolling Resistance Factor
 = 20 kg/t × (6 kg/t/cm × cm)
 = 40 lb/ton + (30 lb/ton/inch × inches)

Rolling Resistance
 = RR Factor (kg/t) × GMW (tons)
 = RR Factor (lb/ton) × GMW (tons)

Rolling Resistance
 = 2% of GMW + 0.6% of GMW per cm tire penetration
 = 2% of GMW + 1.5% of GMW per inch tire penetration

% Grade = $\frac{\text{vertical change in elevation (rise)}}{\text{corresponding horizontal distance (run)}}$

Grade Resistance Factor = 10 kg/m ton × % grade
 = 20 lb/ton × % grade

Grade Resistance = GR Factor (kg/t) × GMW (tons)
 = GR Factor (lb/ton) × GMW (tons)

Grade Resistance = 1% of GMW × % grade

Total Resistance
 = Rolling Resistance (kg or lb) + Grade Resistance (kg or lb)

Total Effective Grade (%) = RR (%) + GR (%)

Usable pull (traction limitation) = Coeff. of traction × weight on drivers
 = Coeff. of traction × (Total wt × % on drivers)

Pull required = Rolling Resistance + Grade Resistance
 = Total Resistance

Total Cycle Time = Fixed time + Variable time

Fixed time: See respective machine production section.

Variable time = Total haul time + Total return time

Travel Time = $\frac{\text{Distance (m)}}{\text{Speed (m/min)}}$
 = $\frac{\text{Distance (ft)}}{\text{Speed (fpm)}}$

Cycles per hour = $\frac{60 \text{ min/hr}}{\text{Total cycle time (min/cycle)}}$

Adjusted production = Hourly production × Efficiency factor

No. of units required = $\frac{\text{Hourly production required}}{\text{Unit hourly production}}$

No. of scrapers a pusher will load = $\frac{\text{Scraper cycle time}}{\text{Pusher cycle time}}$

Pusher cycle time (min) = 1.40 Load time (min) + 0.25 min

Grade Horsepower = $\frac{\text{GMW (kg)} \times \text{Total Effective Grade} \times \text{Speed (km/h)}}{273.75}$
 = $\frac{\text{GMW (lb)} \times \text{Total Effective Grade} \times \text{Speed (mph)}}{375}$

LOGGING AND FOREST PRODUCTS

CONTENTS

Estimating Wheel and Track	
Skidder production	24-1
Log skidding resistance table	24-3
Metric example problem	24-4
English example problem	24-5
Load capacity curves for Wheel Loaders and Integrated Toolcarriers	24-7
Forestry machines	24-18
Log Loader lift and range diagrams	24-21
Heel Boom grapples	24-39
Woodchips Dozer & Scoops	24-40
High Speed Disc Saws	24-40
320B Stroke Delimber	24-41
Logging Forks for Wheel Loaders and Integrated Toolcarriers	24-44
Log Volume Tables	24-46
Weights of Commercially Important Woods	24-48
Estimating Number of Trees	24-51
Comparison of Log Rules	24-51
Measurement Definitions	24-52

Introduction

This chapter gives information for estimating performance of Cat machines in logging. The chapters on Earthmoving and Owning and Operating Costs should be understood before applying this chapter. Because of variations in conditions, actual experience should be considered whenever it is available.

24

ESTIMATING WHEEL AND TRACK SKIDDER PRODUCTION

1. Determine the weight of the average log and multiply log loads expected to be skidded. If average weights or volumes are not available from local timber cruise or log scale data, they can be estimated using the following procedure:
 - Determine length and both end diameters of the average size log to be skidded. Then determine its volume using tables in this section.
 - Determine average log weight based on its estimated volume and green density for the species being skidded using the tables in this section.
2. Determine operating weight of machines being considered. If one end of the logs will be suspended by a cable arch or hydraulic grapple, estimate the percent of log weight that will be transferred to the machine. Then determine total machine plus load transferred weight. Weight transfer of small diameter logs with substantial taper may be as high as two-thirds when skidded with large end ahead and as low as one-third with small end ahead. Large diameter logs with little taper will have weight transfer closer to 50% of their weight.

3. Determine the average percent grade on the proposed skid trails. Then determine the grade resistance or assistance for the haul and return portions of the cycle for each machine considered. If there are significant differences in grade along the proposed trails, the grade resistance or assistance must be determined for each section of the trails. For the haul portion of the cycle, grade resistance must be determined for log loads.

$$\text{Grade Resistance in Kilograms} = \% \text{ Grade} \times 10 \text{ kg/metric ton} \times \text{GMW in tons}$$

$$\text{Grade Resistance in Pounds} = \% \text{ Grade} \times 20 \text{ lb/U.S. ton} \times \text{GMW in tons}$$

4. Determine the average rolling resistance for each wheel-type machine being considered based on expected tire penetration or on typical rolling resistance factors shown in the Tables Section. If there are significant differences in underfoot conditions and tire penetration along the proposed skid trails, rolling resistance must also be determined for machines with and without loads.

$$\text{RR Factor in kg/metric ton} = 20 \text{ kg/t} + (6 \text{ kg/t/cm} \times \text{tire penetration in cm})$$

$$\text{RR Factor in lb/U.S. ton} = 40 \text{ lb/ton} + (30 \text{ lb/ton/inch} \times \text{tire penetration in inches})$$

$$\text{Total Rolling Resistance in Kilograms} = \text{RR Factor in kg/t} \times \text{GMW in metric tons}$$

$$\text{Total Rolling Resistance in Pounds} = \text{RR Factor in lb/U.S. ton} \times \text{GMW in tons}$$

5. Determine skidding resistance for log loads on each machine using the tables on the next page. For log weights and grades not shown, skidding resistance must be determined by interpolation. The arch skidding tables must be used when one end of the logs will be suspended by a cable arch or hydraulic grapple. The ground skidding tables are used when logs are not suspended. If there are significant differences in grade along the proposed trails, then skidding resistance must be determined for each section.

6. Determine the total resistance or pull required to overcome the total of grade, rolling, and skidding resistance. Total resistance must be determined for each machine and skid trail section on both haul and return portions of the cycles.

$$\text{Total Resistance on Return} = \text{Grade Resistance} + \text{Rolling Resistance}$$

$$\text{Total Resistance on Haul} = \text{Grade Resistance} + \text{Rolling Resistance} + \text{Skidding Resistance}$$

7. Determine the traction limitations or usable pull for each machine with and without loads if one end of the logs will be suspended. Usable pull is estimated using the approximate coefficient of traction factors for the soil conditions shown in Tables Section.

$$\text{Usable Pull in Kilograms} = \text{Coefficient of Traction} \times \text{GMW in Kilograms}$$

$$\text{Usable Pull in Pounds} = \text{Coefficient of Traction} \times \text{GMW in Pounds}$$

8. Determine maximum return and haul travel speeds for each machine and skid trail section on those loads whose total resistance (required pull) estimated in step 6 is less than the usable pull estimated in step 7. Travel speeds for track-type tractors are estimated from the drawbar pull graphs in the Tractor Section. Wheel skidder travel speeds are estimated from the rim-pull graphs in the Skidder Section.

9. Determine return and haul travel times for each machine, load and segment based on the length of each skid trail segment and the speeds determined in step 8.

$$\text{Travel Time in Minutes} = \text{Distance in meters} \div [(\text{speed in km/h}) (16.7)]$$

$$\text{Travel Time in Minutes} = \text{Distance in feet} \div [(\text{speed in mph}) (88)]$$

10. Determine fixed times to maneuver machines and to hook, unhook and deck logs based on local experience.

11. Determine total cycle time and cycles per hour for each machine with log loads on each skid trail.

$$\text{Cycle Time} = \text{Return Time} + \text{Haul Time} + \text{Fixed Time}$$

$$\text{Cycles/Hour} = 60 \div \text{cycle time in minutes}$$

12. Determine production for each machine on each skid trail at the expected job efficiency in the desired units, such as number of logs, weight of logs, cubic volume, board feet, cords, etc., using the appropriate conversion factors.

$$\text{Units/Hour} = \text{Cycles/Hour} \times \text{Unit/Cycle} \times \text{Job Efficiency}$$

DRAWBAR KILOGRAMS PULL Required To Overcome Log Skidding Resistance

GROUND SKIDDING — Log Lengths										
*Grade	Load Weight (kg)									
	500	1000	1500	2000	2500	3000	3500	4000	4500	5000
	Drawbar Kilograms Required									
30% Upgrade	683	1205	1808	2410	3013	3615	4218	4820	5423	6025
20% Upgrade	550	1100	1650	2200	2750	3300	3850	4400	4950	5500
10% Upgrade	498	995	1493	1990	2488	2985	3483	3980	4478	4975
Level	445	890	1335	1780	2225	2670	3115	3560	4005	4450
10% Downgrade	392	784	1176	1568	1960	2352	2744	3136	3528	3920
20% Downgrade	340	679	1091	1358	1698	2037	2377	2716	3056	3395
30% Downgrade	287	574	861	1148	1435	1722	2009	2296	2583	2870
ARCH SKIDDING — Log Lengths										
30% Upgrade	603	964	1246	1527	1809	2090	2377	2653	2935	3216
20% Upgrade	513	750	987	1224	1461	1698	1935	2172	2409	2645
10% Upgrade	343	535	728	920	1113	1305	1498	1690	1883	2075
Level	167	317	468	618	769	919	1070	1220	1371	1521
10% Downgrade	—	105	207	313	417	521	625	729	833	937
20% Downgrade	—	—	—	—	30	100	170	239	310	380

24

DRAWBAR POUNDS PULL Required To Overcome Log Skidding Resistance

GROUND SKIDDING — Log Lengths										
*Grade	Load Weight (lb)									
	1000	2000	3000	4000	5000	6000	7000	8000	9000	10 000
	Drawbar Pounds Pull Required									
30% Upgrade	1365	2410	3615	4820	6025	7230	8435	9650	10 845	12 050
20% Upgrade	1100	2200	3300	4400	5500	6600	7700	8800	9900	11 000
10% Upgrade	995	1990	2985	3980	4975	5970	6965	7960	8955	9950
Level	890	1780	2670	3560	4450	5340	6230	7120	8010	8900
10% Downgrade	784	1568	2352	3136	3920	4704	5488	6272	7056	7840
20% Downgrade	679	1358	2037	2716	3395	4074	4753	5432	6111	6790
30% Downgrade	574	1148	1722	2296	2870	3444	4018	4592	5166	5740
ARCH SKIDDING — Log Lengths										
30% Upgrade	1205	1928	2491	3054	3617	4180	4753	5306	5869	6432
20% Upgrade	1025	1499	1973	2447	2921	3395	3869	4343	4817	5291
10% Upgrade	685	1070	1455	1840	2225	2610	2995	3380	3765	4150
Level	333	634	935	1236	1537	1838	2139	2440	2741	3042
10% Downgrade	—	209	414	625	833	1041	1249	1457	1665	1873
20% Downgrade	—	—	—	—	59	199	339	479	619	759

Data taken on dry, smooth, clay loam slopes, Resistances are less on wet soil.

Source — Central States Forest Experiment Station, U.S. Forest Service.

$$*\% \text{ Grade} = \frac{\text{Vertical Rise}}{\text{Horizontal Distance}} \times 100\%$$

Example problem (Metric)

Determine the production capabilities in logs per hour of a 525 grapple skidder and a 527 grapple skidder in a skidding application. Operating weights are 13 865 kilograms for the 525 with grapple and 19 353 kilograms for the 527 with grapple. The timber is Radiata pine with the average log being 18 meters long with a butt diameter of 350 millimeters and a top diameter of 100 millimeters.

The average skid trail is 150 meters long with a 5% average adverse skidding grade and 75 millimeters average tire penetration. The coefficient of traction is estimated to be 0.5 for wheels and 0.8 for tracks.

The logs will be bunched in groups of 6 logs for the 525 and 9 logs for the 527. Maneuver time for a log hook-up averages 0.3 minutes and hook-up time averages 0.2 minutes. Landing maneuver, decking, and unhook time average a total of 1.0 minute.

1. Average Load Size:

Volume/Log = $(1.73 + 0.014)/2 = 0.935 \text{ m}^3$

Density of

Radiata Pine = 865 kg/m^3

Weight/Log = $865 \times 0.935 = 809 \text{ kg}$

Six Log Load = $809 \times 6 = 4853 \text{ kg}$

Nine Log Load = $809 \times 9 = 7279 \text{ kg}$

2. Gross Machine Weights:

525 Empty GMW = $13\,865 \text{ kg} = 13.8 \text{ Metric tons}$

527 Empty GMW = $19\,353 \text{ kg} = 19.3 \text{ Metric tons}$

525 Load Weight Transferred = $0.6 \times \text{Load Weight}$

527 Load Weight Transferred = $0.6 \times \text{Load Weight}$

525 Loaded:

$13\,865 + (0.6 \times 4853) = 16\,777 \text{ kg} = 16.78 \text{ Metric tons}$

527 Loaded:

$19\,353 + (0.6 \times 7279) = 23\,720 \text{ kg} = 23.72 \text{ Metric tons}$

3. Grade Resistance/Assistance:

Grade Assistance: Return = $5 \times 10 \text{ kg/T} \times \text{GMW}$
in tons (empty)

Grade Resistance: Haul = $5 \times 10 \text{ kg/T} \times \text{GMW}$
in tons

	525	527
Assistance:		
Return Empty	(-690 kg)	(-965 kg)
Resistance:		
Haul Load	839 kg	1186 kg

4. Rolling Resistance — 525:

RR Factor = $20 \text{ kg/ton} + (6 \text{ kg/ton/cm} \times 7.5 \text{ cm}) = 65 \text{ kg/T}$

RR = $65 \times \text{GMW}$ in tons

Resistance:

Return = $65 \times 13.8 = 897 \text{ kg}$

Haul = $65 \times 16.78 = 1091 \text{ kg}$

5. Skidding Resistance (derived from tables in this section):

Skid Resistance/Log = 450 kg

Skid Resistance — Six Logs = 2700 kg

Skid Resistance — Nine Logs = 4050 kg

6. Total Resistance — Required Pull:

525 Return Empty = $(-690) + 897 = 207 \text{ kg}$

525 Haul Load = $839 + 1091 + 2700 = 4630 \text{ kg}$

527 Return Empty = $(-965) \text{ kg}$

527 Haul Load = $1186 + 4050 = 5236 \text{ kg}$

7. Usable Pull:

525 Return Empty = $0.5 \times 13\,865 = 6933 \text{ kg}$

525 Haul Load = $0.5 \times 16\,777 = 8389 \text{ kg}$

527 Return Empty = $0.8 \times 19\,353 = 15\,482 \text{ kg}$

527 Haul Load = $0.8 \times 23\,720 = 18\,976 \text{ kg}$

8. **Travel Speeds:** from rimpull/drawbar pull graphs

	525	527
Return Empty	14 km/h*	6.4 km/h*
Haul Load	6 km/h	3.2 km/h

*Depending upon haul road conditions and job site factors, a slower speed may be preferred for a safer return.

9. **Travel Times:**

Travel Time = 150 m x 0.9 (speed in km/h)

	525	527
Return Empty	0.64 min.	1.4 min.
Haul Load	1.5 min.	2.8 min.

10. **Fixed Times:**

Total Fixed Time = 0.3 + 0.2 + 1.0 = 1.5 min.

11. **Cycles per Hour:**

Cycles/hr = (60 min/hr)/(Total Cycle Time in min)

	525	527
Total Cycle Time	3.64 min.	5.7 min.
Cycles per Hour	16.5	10.5

12. **Production per Hour:**

Logs/Hour = Cycles/hr × Logs/cycle

	525	527
Logs/cycle	6	9
Logs/hour	99	95

Example problem (English)

Determine the production capabilities in logs per hour of a 525 grapple skidder and a 527 grapple skidder in a thinning application. Operating weights are 30,570 pounds for the 525 with grapple and 42,670 pounds for the 527 with grapple. The timber is Loblolly pine with the average log being 60 feet long with a butt diameter of 14 inches and a top diameter of 4 inches.

The average skid trail is 500 feet long with a 5% average adverse skidding grade and 3 inches average tire penetration. The coefficient of traction is estimated to be 0.5 for wheels and 0.8 for tracks.

The logs will be bunched in groups of 6 logs for the 525 and 9 logs for the 527. Maneuver time for a log hook-up averages 0.3 minutes and hook-up time averages 0.2 minutes. Landing maneuver, decking, and unhook time average a total of 1.0 minute.

1. **Average Load Size:**

$$\text{Volume/Log} = (64 + 5.2)/2 = 34.6 \text{ ft}^3$$

Density of

$$\text{Loblolly Pine} = 62 \text{ lb/ft}^3$$

$$\text{Weight/Log} = 62 \times 34.6 = 2145 \text{ lb}$$

$$\text{Six Log Load} = 2145 \times 6 = 12,871 \text{ lb}$$

$$\text{Nine Log Load} = 2145 \times 9 = 19,305 \text{ lb}$$

2. **Gross Machine Weights:**

$$525 \text{ Empty GMW} = 30,570 \text{ lb} = 15.3 \text{ tons}$$

$$527 \text{ Empty GMW} = 42,670 \text{ lb} = 21.3 \text{ tons}$$

$$525 \text{ Load Weight Transferred} = 0.6 \times \text{Load Weight}$$

$$527 \text{ Load Weight Transferred} = 0.6 \times \text{Load Weight}$$

525 Loaded:

$$30,570 + (0.6 \times 12,871) = 38,293 \text{ lb} = 19.1 \text{ tons}$$

527 Loaded:

$$42,670 + (0.6 \times 19,306) = 54,254 \text{ lb} = 27.1 \text{ tons}$$

3. **Grade Resistance/Assistance:**

$$\text{Grade Assistance: Return} = 5 \times 20 \text{ lb/T} \times \text{GMW in tons}$$

$$\text{Grade Resistance: Haul} = 5 \times 20 \text{ lb/T} \times \text{GMW in tons}$$

	525	527
Assistance:		
Return Empty	(-1530 lb)	(-2130 lb)
Resistance:		
Haul Load	1910 lb	2710 lb

4. **Rolling Resistance — 525:**

RR Factor = 40 lb/ton + (30 lb/ton/in × 3 in)
= 130 lb/T

RR = 130 × GMW in tons

Resistance:

Return = 130 × 15.3 = 1989 lb

Haul = 130 × 19.1 = 2483 lb

5. **Skidding Resistance** (derived from tables in this section):

Skid Resistance/Log = 1169 lb

Skid Resistance — Six Logs = 7014 lb

Skid Resistance — Nine Logs = 10,521 lb

6. **Total Resistance — Required Pull:**

525 Return Empty = (-1530) + 1989 = 459 lb

525 Haul Load = 1910 + 2483 + 7014 = 11,407 lb

527 Return Empty = (-2130) lb

527 Haul Load = 2710 + 10,521 = 13,231 lb

7. **Usable Pull:**

525 Return Empty = 0.5 × 30,570 = 15,285 lb

525 Haul Load = 0.5 × 38,293 = 19,146 lb

527 Return Empty = 0.8 × 42,670 = 34,136 lb

527 Haul Load = 0.8 × 54,254 = 43,403 lb

8. **Travel Speeds:** from rimpull/drawbar pull graphs

	525	527
Return Empty	8.7 mph*	3.9 mph*
Haul Load	3.7 mph	2 mph

*Depending upon haul road conditions and job site factors, a slower speed may be preferred for a safer return.

9. **Travel Times:**

Travel Time = 500 ft × (60 min/hr)/
(5280 ft/mi)/(speed in mph)

	525	527
Return Empty	0.65 min.	1.45 min.
Haul Load	1.53	2.84

10. **Fixed Times:**

Total Fixed Time = 0.3 + 0.2 + 1.0 = 1.5 min.

11. **Cycles per Hour:**

Cycles/hr = (60 min/hr)/(Total Cycle Time in min)

	525	527
Total Cycle Time	3.68 min.	5.79 min.
Cycles per Hour	16.3	10.4

12. **Production per Hour:**

Logs/hr = Cycles/hr × Logs/cycle

	525	527
Logs/cycle	6	9
Logs/hour	98	94



LOAD CAPACITY CURVES FOR WHEEL LOADERS AND INTEGRATED TOOLCARRIERS EQUIPPED WITH FORKS

Definitions:

Hydraulic Capacity: Weight that the hydraulic system will lift with the rear of the loader anchored and the load center of gravity midway on the fork tines. Hydraulic capacity is not increased by counterweighting.

Tipping Load: The loaded weight positioned as described above, which will lift the rear wheels off the ground with the machine in a static condition. Static tipping load curves for wheel loaders equipped with log or lumber forks are based on full machine articulation.

Tipping load capacities are affected by counterweight and distance of the load center of gravity from the front axle and degree of articulation. Fork center of gravity and fork weight can also affect tipping load.

Maximum Operating Load: Maximum operating load should be based on static tipping load ratings (tines level) and requires a firm, smooth, well-maintained operating area. Maximum operating loads can be affected by:

- Underfoot conditions.
- Position or height the load is carried.
- Fork position or attitude.
- Degree machine is articulated during maneuvering.



Example problem:

Wheel Loader Selection 966F vs 950F

Optimum millyard performance depends on efficient and proper use of wheel loaders performing unloading, sorting and decking applications. The following steps will aid in the proper wheel loader selection.

Step 1: Determine the basic mill requirements (job description).

EXAMPLE:

Logs arrive at the mill on trucks equipped with double bunk trailers. Logs are a variety of hardwoods, but white oak makes up the majority of wood received. The trucks must be off-loaded by a wheel loader equipped with log forks.

In addition to the off-loading, a primary loader requirement is to supply the mill with raw material in a load-and-carry operation. The loader must also sort logs by species, grade and size, and transport the excess logs from the unloading area to the storage decks.

- Maximum sawmill requirements — 544 metric tons/8 hr. day (600 U.S. tons).
- Maximum wood received — 30 truckloads/8 hr. day.
- Average number of logs per truckload — 20.
- Average log specifications:
 - length 4.9 m (16').
 - butt diameter 660 mm (26").
 - top diameter 430 mm (17").
- Maximum truck stake height — 3.98 m (13'1").
- Maximum haul distance (one way) from log storage deck to the mill — 153 m (500').
- Haul and return to mill in 2nd forward — 10% effective grade.
- Fixed times — load forks 0.7 min.
 - maneuver and dump 0.5 min.
 - truck unloading 1.0 min.
- Average log weight = 1180 kg/log (2600 lb/log)
Refer to Weights and Measure section of this handbook to obtain appropriate log volume and density information.

Step 2: Determine the basic machine options and capacities.

Refer to Capacity curves in the Performance Handbook under Logging and Forest Products section. For other fork configurations not listed contact the Forest Machinery Unit for performance curves. Also refer to attachment adaptability section for information needed for performance curves.

EXAMPLE:

Consider a 950F vs. 966F. Both are equipped with logging fork.

950F

Static Tipping Load	10 000 kg (22,000 lb)
Hydraulic Lift Capacity	11 600 kg (25,520 lb)
Maximum Operating Load	10 000 kg (22,000 lb)

966F

Static Tipping Load	13,500 kg (29,700 lb)
Hydraulic Lift Capacity	14,500 kg (31,900 lb)
Maximum Operating Load	13,500 kg (29,700 lb)

Step 3: Determine cycle times.

Refer to Production Travel Time Charts in the Wheel Loader section of the Performance Handbook.

EXAMPLE:
(Supplying the mill)

Description	Time (950F)	Time (966F)
Haul and return	1.16 min	1.14 min
Load Forks*	0.7 min	0.7 min
Maneuver and dump*	0.5 min	0.5 min
TOTAL	2.36 min	2.34 min
Cycles/45-min hr =	19.06	19.23

(Off-loading trucks)

Description	Time (950F)	Time (966F)
Truck unloading*	1.0 min	1.0 min
Load Forks*	0.7 min	0.7 min
Maneuver and dump*	0.5 min	0.5 min
TOTAL	2.2 min	2.2 min
Cycles/45-min hr =	20.45	20.45

*Fixed times which should be based on local experience.

Step 4: Calculate Production

EXAMPLE:
Mill requirements:

— 950F

$$\frac{544\ 320\ \text{kg}\ (1,200,000\ \text{lb})/8\ \text{hr/day}}{10\ 000\ \text{kg}\ (22,000\ \text{lb})/\text{loader\ cycle}} =$$

$$\frac{55\ \text{loader\ cycles}}{8\ \text{hr/day}}$$

$$\frac{55\ \text{loader\ cycles}/8\ \text{hr/day}}{19.06\ \text{cycles}/45\text{-min\ hr}} = 2.88\ \text{hr/day}$$

required to supply mill

— 966F

$$\frac{544\ 320\ \text{kg}\ (1,200,000\ \text{lb})/8\ \text{hr/day}}{13\ 500\ \text{kg}\ (29,700\ \text{lb})/\text{loader\ cycle}} =$$

$$\frac{41\ \text{loader\ cycles}}{8\ \text{hr/day}}$$

$$\frac{41\ \text{loader\ cycles}/8\ \text{hr/day}}{19.23\ \text{cycles}/45\text{-min\ hr}} = 2.13\ \text{hr/day}$$

required to supply mill

Off-Load Requirements:

— 950F

$$20\ \text{logs/truck} \times 30\ \text{truckloads/day} = 600\ \text{logs/day}$$

$$600\ \text{logs/day} \times 1180\ \text{kg}\ (2600\ \text{lb})/\text{log} = 707\ 616\ \text{kg/day}$$

or
1,560,000 lbs/day
Incoming Wood

$$\frac{707\ 616\ \text{kg}\ (1,560,000\ \text{lb})/8\ \text{hr/day}}{10,000\ \text{kg}\ (22,000\ \text{lb})/\text{loader\ cycle}} =$$

$$\frac{71\ \text{loader\ cycles}}{8\ \text{hr/day}}$$

$$\frac{71\ \text{loader\ cycles}/8\ \text{hr/day}}{29.45\ \text{cycles/hr}} = 3.47\ \text{hr/day}$$

required to off-load wood

— 966F

$$20\ \text{logs/truck} \times 30\ \text{truckloads/day} = 600\ \text{logs/day}$$

$$600\ \text{logs/day} \times 1180\ \text{kg}\ (2600\ \text{lb})/\text{log} = 707\ 616\ \text{kg/day}$$

or
1,560,000 lbs/day
Incoming Wood

$$\frac{707\ 616\ \text{kg}\ (1,560,000\ \text{lb})/8\ \text{hr/day}}{13,500\ \text{kg}\ (29,700\ \text{lb})/\text{loader\ cycle}} =$$

$$\frac{53\ \text{loader\ cycles}}{8\ \text{hr/day}}$$

$$\frac{53\ \text{loader\ cycles}/8\ \text{hr/day}}{20.45\ \text{cycles/hr}} = 2.59\ \text{hr/day}$$

required to off-load wood

Total Production Required:

— 950F = 2.88 hr/day to supply mill
3.47 hr/day to off-load
6.35 hr/day total time

— 966F = 2.13 hr/day to supply mill
2.59 hr/day to off-load wood
4.72 hr/day total time

Step 5: Determine Wheel Loader selection.

EXAMPLE:

From the production study completed and assuming 100% efficiency it appears both machines are capable of handling the maximum daily production. The 950F and 966F will have 1.65 hrs/day and 3.28 hrs/day respectively to handle unscheduled activities such as sorting, storage and yard clean-up. However, after comparing the maximum hinge pin height for the two machines, the 950F is not capable of clearing the stakes with a load. This leaves the 966F as the machine to recommend, since it can handle all restrictions and production requirements.

- 914G
- 924F

914G with Balderson Lumber and Log Fork

924F with Balderson Lumber and Log Fork

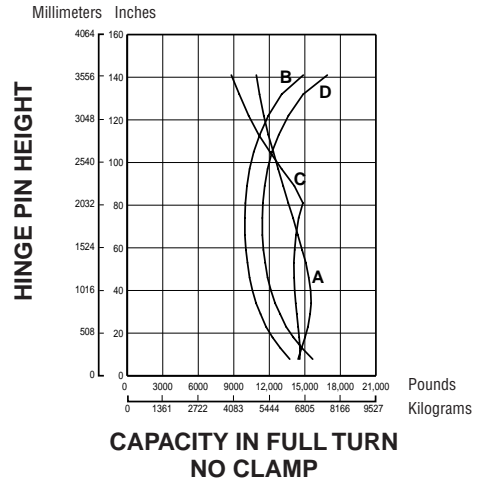
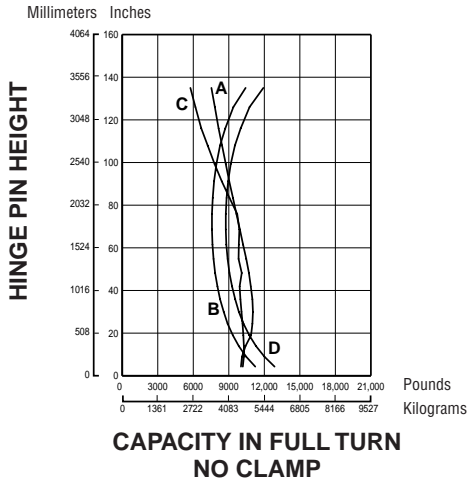

KEY

- A — Hydraulic Lift Capacity Fork Racked
- B — Static Tipping Load Full 40° Turn Fork Level
- C — Hydraulic Lift Capacity Fork Level
- D — Static Tipping Load Machine Straight, Fork Level

KEY

- A — Hydraulic Lift Capacity Fork Racked
- B — Static Tipping Load Full 40° Turn Fork Level
- C — Hydraulic Lift Capacity Fork Level
- D — Static Tipping Load Machine Straight, Fork Level

Curves based on machine with full fuel tank, operator, 17.5R25 tires and Balderson 125-9293 lumber/log fork without top clamp. Fork weight is 616 kg (1358 lb). Total operating weight, 7464 kg (16,444 lb). Forks of other dimensions or weight may affect machine capacity. Consult your Caterpillar Dealer for additional fork data.

Curves based on machine with full fuel tank, operator, 17.5R25 tires and Balderson 8918C3 lumber/log fork without top clamp. Fork weight 834 kg (1838 lb). Total operating weight, 9280 kg (20,444 lb). Forks of other dimensions or weight may affect machine capacity. Consult your Caterpillar Dealer for additional fork data.

	Change in Operating Weight	Change in Articulated Static Tipping Load	
		Racked	Level
Add ROPS canopy	+317 kg (+700 lb)	+309 kg (+682 lb)	+233 kg (+515 lb)
Add ROPS canopy and cab	+527 kg (+1163 lb)	+388 kg (+856 lb)	+345 kg (+762 lb)

	Change in Operating Weight	Change in Articulated Static Tipping Load
		Level
Without ROPS canopy and cab (platform only)	-418 kg (-922 lb)	-258 kg (-569 lb)
Without cab (ROPS/platform)	-207 kg (-456 lb)	-128 kg (-282 lb)

- 928G
- 938G

928G with Balderson Lumber and Log Fork

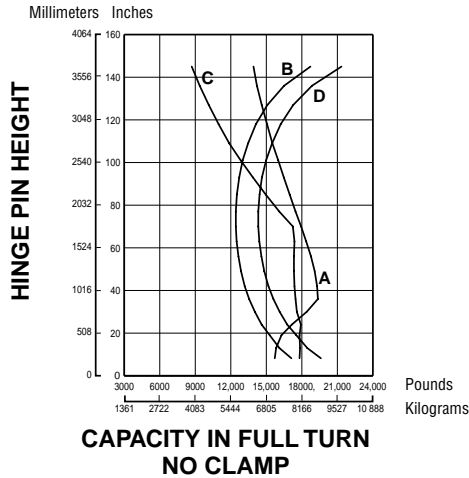

KEY

- A — Hydraulic Lift Capacity Fork Racked
- B — Static Tipping Load Full 40° Turn Fork Level
- C — Hydraulic Lift Capacity Fork Level
- D — Static Tipping Load Machine Straight, Fork Level

Curves based on machine with full fuel tank, operator, ROPS cab, 20.5-25 tires, 250 kg (550 lb) counterweight, lumber/log fork. Total operating weight, 11 603 kg (25,561 lb). Forks of other dimensions or weight may affect machine capacity. Consult your Caterpillar Dealer for additional fork data.

938G Logger with Balderson Millyard Fork

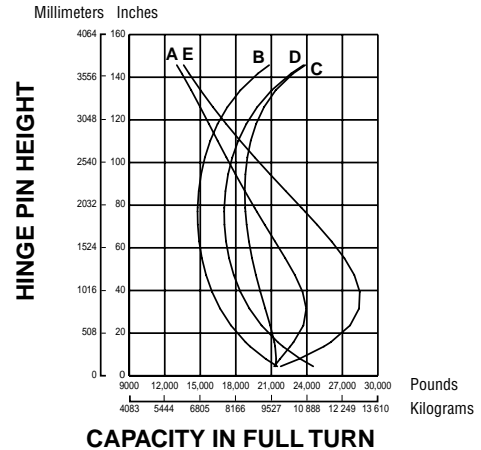

KEY

- A — Hydraulic Lift Capacity 40° Turn, Fork Racked
- B — Static Tipping Load Full 40° Turn Fork Level
- C — Hydraulic Lift Capacity Fork Level
- D — Static Tipping Load Machine Straight, Fork Level
- E — Hydraulic Tilt Capacity Fork Level

Curves based on machine with full fuel tank, operator, ROPS cab, 20.5-25, 16PR(L-2) tires, with 810 kg (1785 lb) rear tire ballast, 562 kg (1240 lb) counterweight, Balderson millyard fork 119-8243.00 with 1345 mm (4'5") tines, 1635 kg (3600 lb) combined weight. Total operating weight, 14 297 kg (31,520 lb).

938G Logger with Balderson Log and Lumber Fork

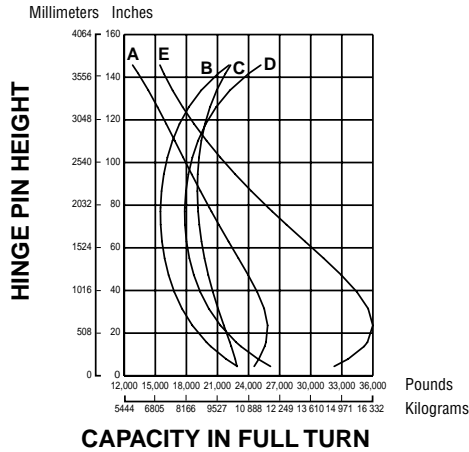

950F Series II Logger with Balderson Logging Fork and Top Clamp

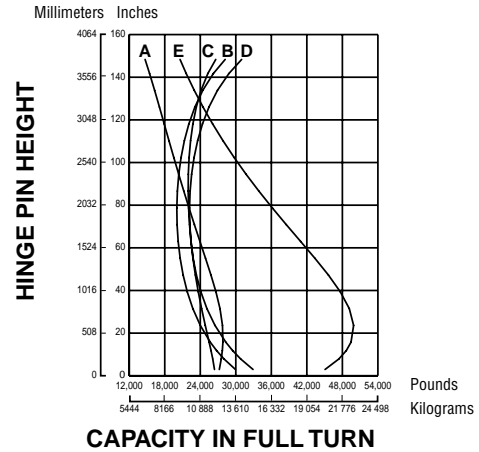

KEY

- A — Hydraulic Lift Capacity 40° Turn, Fork Racked
- B — Articulated Tipping Capacity
- C — Hydraulic Lift Capacity Fork Level
- D — Static Tipping Load Machine Straight, Fork Level
- E — Hydraulic Tilt Capacity Fork Level

Curves based on machine with full fuel tank, operator, ROPS cab, 20.5-25, 16PR(L-2) tires, and 562 kg (1240 lb) counterweight, with 810 kg (1785 lb) rear tire ballast Balderson log and lumber fork with 1225 mm (4'0") tines, 1660 kg (3660 lb) total weight. Total operating weight, 14 332 kg (31,595 lb).

KEY

- A — Hydraulic Lift Capacity 35° Turn, Fork Racked
- B — Articulated Tipping Capacity
- C — Hydraulic Lift Capacity Fork Level
- D — Static Tipping Load Machine Straight, Fork Level
- E — Hydraulic Tilt Capacity Fork Level

Curves and operating weight on chart are based on machine equipped with 23.5-25, 16PR(L-3) tires, counterweight, 1244 kg (2743 lb) ballast in rear tires, full fuel tank, operator, Balderson 8961C2 (BLF 950 ED-TC) log fork with 1397 mm (4'7") tines and top clamp, 2018 kg (4450 lb) combined weight. Total operating weight, 18 255 kg (40,245 lb). Forks of other dimensions or weight may affect machine capacity. Consult your Caterpillar dealer for additional information.

- 950F Series II
- 966F Series II

950F Series II Logger with Balderson Millyard Fork and Top Clamps

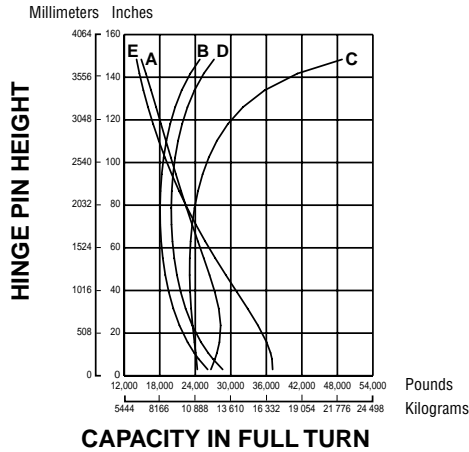

966F Series II Logger with Balderson Millyard Fork

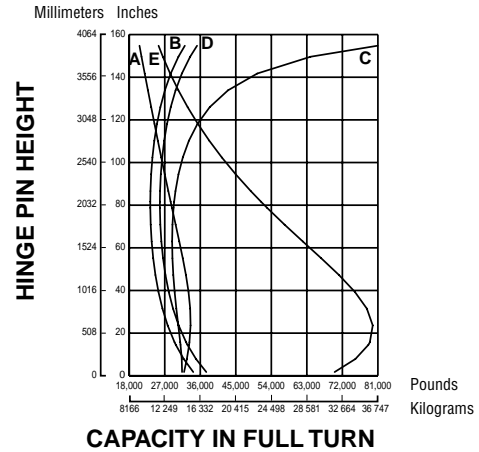

KEY

- A — Hydraulic Lift Capacity 35° Turn, Fork Racked
- B — Articulated Tipping Capacity
- C — Hydraulic Lift Capacity Fork Level
- D — Static Tipping Load Machine Straight, Fork Level
- E — Hydraulic Tilt Capacity Fork Level

Curves and operating weight on chart are based on machine equipped with 23.5-25 16PR(L-3) tires 1069 kg (3246 lb) counterweight with 1244 kg (2587 lb) ballast in rear tires, full fuel tank, operator, Balderson millyard fork 5544C3 1930 kg (4250 lb) total weight. Total operating weight, 17 990 kg (39,660 lb).

KEY

- A — Hydraulic Lift Capacity 35° Turn, Fork Racked
- B — Articulated Tipping Capacity
- C — Hydraulic Lift Capacity Fork Level
- D — Static Tipping Load Machine Straight, Fork Level
- E — Hydraulic Tilt Capacity Fork Level

Curves and operating weight on chart are based on machine equipped with 26.5-25, 20PR(L-3) tires, counterweight with 1515 kg (3440 lb) ballast in rear tires, full fuel tank, operator, Balderson millyard fork 5831C1 with 1600 mm (5'3") tines and top clamp, 2450 kg (5400 lb) combined weight. Total operating weight, 22 740 kg (50,130 lb).

966F Series II Logger with Balderson Logging Fork

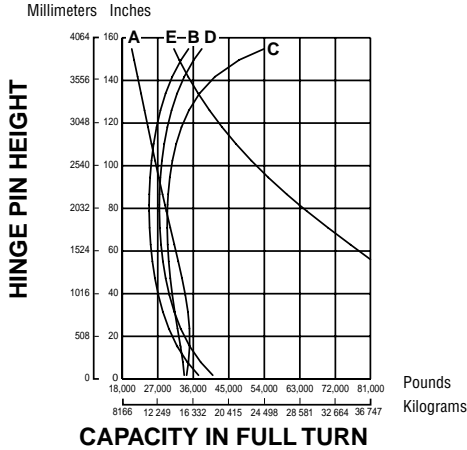

980G Logger with Balderson Millyard Fork

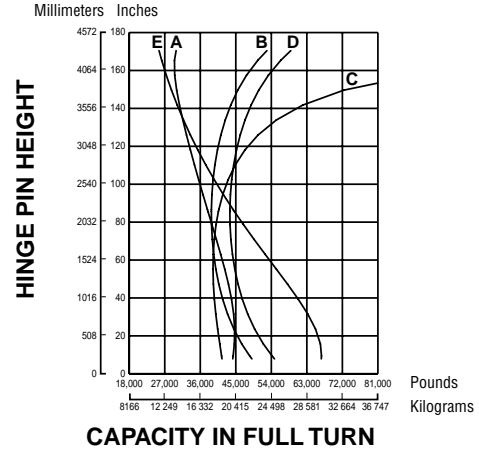

KEY

- A — Hydraulic Lift Capacity 35° Turn, Fork Racked
- B — Articulated Tipping Capacity
- C — Hydraulic Lift Capacity Fork Level
- D — Static Tipping Load Machine Straight, Fork Level
- E — Hydraulic Tilt Capacity Fork Level

Curves and operating weight on chart are based on machine equipped with 26.5-25, 20PR(L-3) tires, counterweight with 1515 kg (3440 lb) ballast in rear tires, full fuel tank, operator, Balderson logging fork 9209C with 1600 mm (5'3") tines and top clamp, 2360 kg (5200 lb) combined weight. Total operating weight, 22 634 kg (49,910 lb).

KEY

- A — Hydraulic Lift Capacity 35° Turn, Fork Racked
- B — Articulated Tipping Capacity
- C — Hydraulic Lift Capacity Fork Level
- D — Static Tipping Load Machine Straight, Fork Level
- E — Hydraulic Tilt Capacity Fork Level

Curves based on logging machine with full fuel tank, ROPS cab, 29.5-25, 22PR(L-3) tires, with 1945 kg (4290 lb) ballast in rear tires, 3810 kg (8400 lb) counterweight, Balderson millyard fork weight of 1850 kg (4075 lb). Total operating weight, 32 680 kg (72,050 lb).

- 980G
- 988F Series II

980G Logger with Balderson Double Top Clamp Log Fork

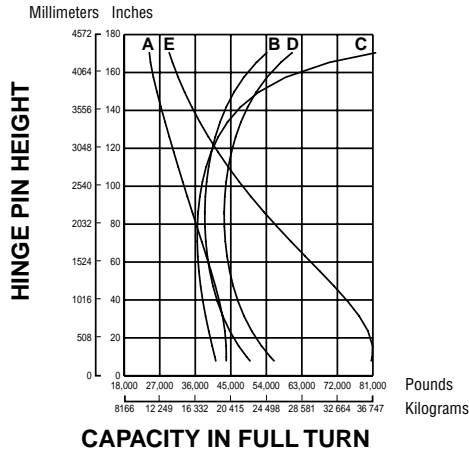

988F Series II Logger with Balderson Millyard Fork

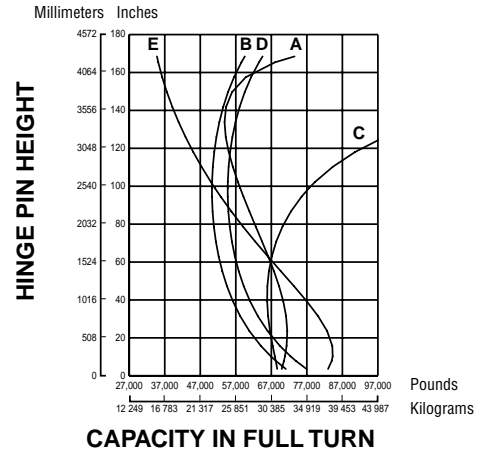

KEY

- A — Hydraulic Lift Capacity 35° Turn, Fork Racked
- B — Articulated Tipping Capacity
- C — Hydraulic Lift Capacity Fork Level
- D — Static Tipping Load Machine Straight, Fork Level
- E — Hydraulic Tilt Capacity Fork Level

Curves based on machine with full fuel tank, operator, ROPS cab, 29.5-25, 22PR(L-3) tires, with 2060 kg (4535 lb) ballast in rear tires, 3200 kg (7050 lb) counterweight, Balderson logging fork with 1830 mm (6'0") tines and top clamp with a combined weight of 3175 kg (7000 lb). Total operating weight, 34 010 kg (74,975 lb).

KEY

- A — Hydraulic Lift Capacity 30° Turn, Fork Racked
- B — Articulated Tipping Capacity
- C — Hydraulic Lift Capacity Fork Level
- D — Static Tipping Load Machine Straight, Fork Level
- E — Hydraulic Tilt Capacity Fork Level

Curves based on machine with full fuel tank, operator, ROPS cab, 35/65-33 30PR(L-4) tires. Standard 4455 kg (9825 lb) counterweight, 2690 kg (5930 lb) ballast in rear tires Balderson 5196C2 millyard fork at 5480 kg (12,080 lb). Total operating weight, 52 765 kg (116,325 lb). Forks or other dimensions or weight will affect machine capacity.

- 988F Series II
- 990 Series II

988F Series II Logger with Balderson Double Top Clamp Log Fork

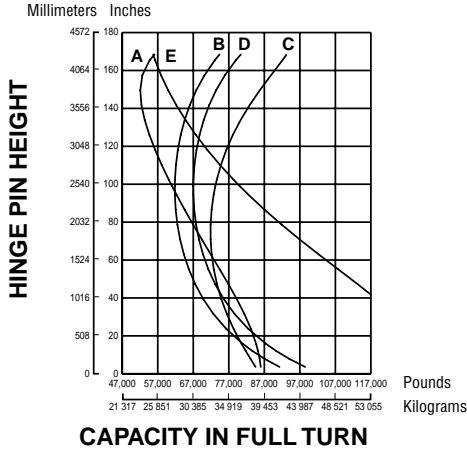

990 Series II Logger with Balderson Double Top Clamp Log Fork

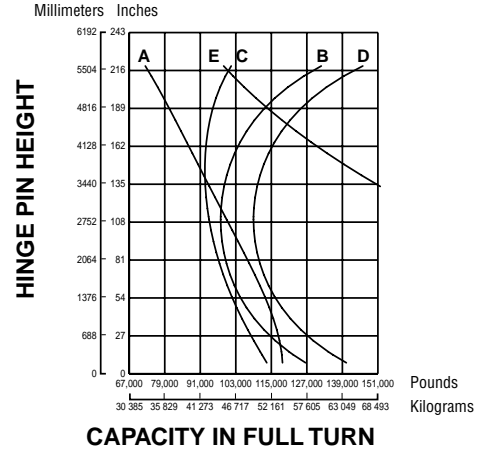

KEY

- A — Hydraulic Lift Capacity 30° Turn, Fork Racked
- B — Articulated Tipping Capacity
- C — Hydraulic Lift Capacity Fork Level
- D — Static Tipping Load Machine Straight, Fork Level
- E — Hydraulic Tilt Capacity Fork Level

Curves based on machine with full fuel tank, operator, ROPS cab, 35/65-33 30PR(L-4) tires. Standard log 4455 kg (9825 lb) counterweight, 2690 kg (5930 lb) ballast in rear tires Balderson 8965C DTC log fork at 4490 kg (9900 lb). Total operating weight 51 775 kg (114,160 lb).

KEY

- A — Hydraulic Lift Capacity 35° Turn, Fork Racked
- B — Articulated Tipping Capacity
- C — Hydraulic Lift Capacity Fork Level
- D — Static Tipping Load Machine Straight, Fork Level
- E — Hydraulic Tilt Capacity Fork Level

Curves based on machine with full fuel tank, operator, ROPS cab, 45/65x39 X-MINE D2 radial tires 4788 kg (10,555 lb) ballast in rear tires, 7845 kg (17,295 lb) logger counterweight, Balderson 114-3557.02 log fork with 2438 mm (8'0") tines and top clamp at 5896 kg (13,000 lb), 1292.1 mm (4'3") link. Total operating weight 87 705 kg (193,360 lb).

- IT14G
- IT24F

IT14G with Balderson Lumber and Log Fork

IT24F with Balderson Lumber and Log Fork

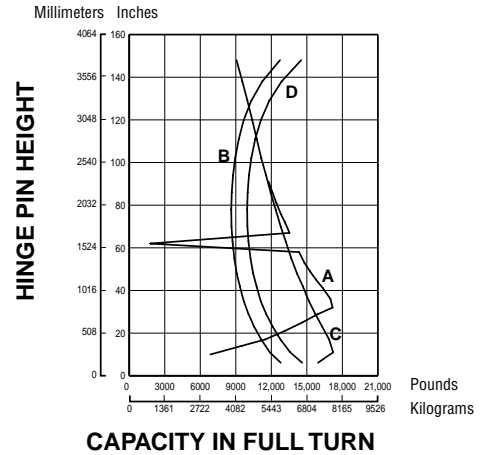
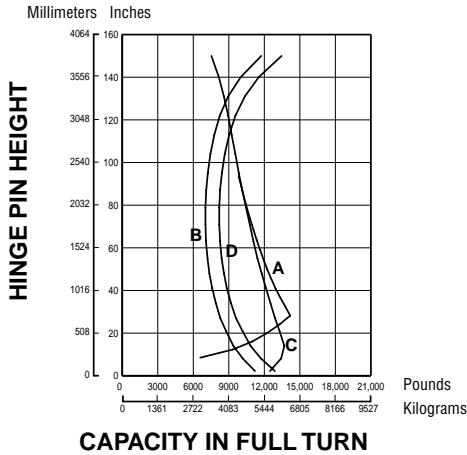

KEY

- A — Hydraulic Lift Capacity Fork Racked
- B — Static Tipping Load Full 40° Turn Fork Level
- C — Hydraulic Lift Capacity Fork Level
- D — Static Tipping Load Machine Straight, Fork Level

KEY

- A — Hydraulic Lift Capacity Fork Racked
- B — Static Tipping Load Full 40° Turn Fork Level
- C — Hydraulic Lift Capacity Fork Level
- D — Static Tipping Load Machine Straight, Fork Level

Curves and operating weight are based on machine equipped with 17.5R25 tires, full fuel tank, 80 kg (176 lb) operator, Balderson 9816C2 lumber and log fork without top clamp. Fork weight is 803 kg (1770 lb). Total operating weight 8020 kg (17,668 lb). Forks of other dimensions or weight may affect machine capacity. Consult your Caterpillar Dealer for additional fork data.

Curves and operating weight are based on machine equipped with 17.5R25 tires, full fuel tank, 80 kg (176 lb) operator, Balderson 9816C2 lumber and log fork without top clamp. Fork weight is 803 kg (1770 lb). Total operating weight 9963 kg (21,948 lb). Forks of other dimensions or weight may affect machine capacity. Consult your Caterpillar Dealer for additional fork data.

- IT28G
- IT38

IT28G with Balderson Lumber and Log Fork

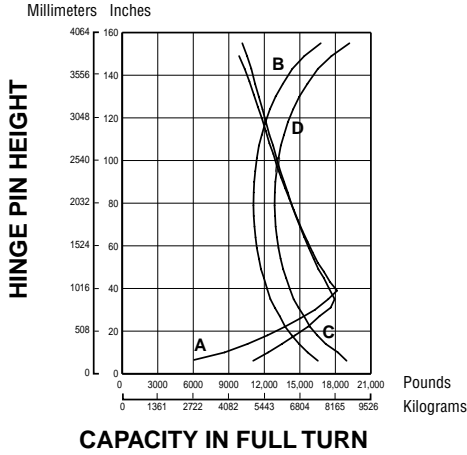

IT38 Logger with Balderson Millyard Fork and Quick Coupler

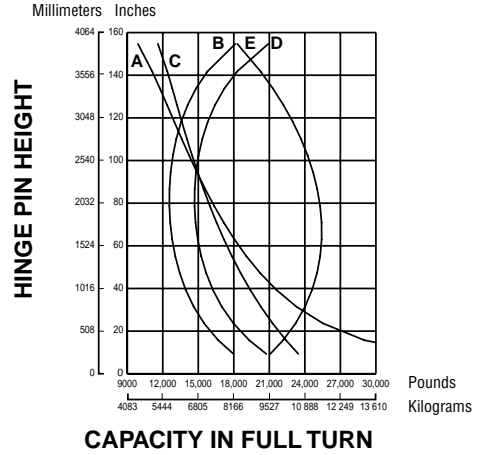

KEY

- A — Hydraulic Lift Capacity Fork Racked
- B — Static Tipping Load Full 40° Turn Fork Level
- C — Hydraulic Lift Capacity Fork Level
- D — Static Tipping Load Machine Straight, Fork Level

Curves and operating weight are based on machine equipped with 20.5-25 tires, 250 kg (550 lb) counterweight, full fuel tank, 80 kg (176 lb) operator, Balderson lumber and log fork. Fork weight 1325 kg (2919 lb). Total operating weight 11 908 kg (26,233 lb). Forks of other dimensions or weight may affect machine capacity. Consult your Caterpillar Dealer for additional fork data.

KEY

- A — Hydraulic Lift Capacity 40° Turn, Fork Racked
- B — Articulated Tipping Capacity
- C — Hydraulic Lift Capacity Fork Level
- D — Static Tipping Load Machine Straight, Fork Level
- E — Hydraulic Tilt Capacity Fork Level

Curves based on machine with full fuel tank, operator, ROPS cab, 20.5-25, 16PR(L-2) tires, with 810 kg (1785 lb) rear tire ballast, 760 kg (1675 lb) counterweight, Balderson millyard fork 103-8617 with 9753C2 coupler 1345 mm (4'5") tines, 1815 kg (4000 lb) combined weight. Total operating weight, 14 097 kg (31,080 lb). Forks of other dimensions or weight may affect machine capacity. Consult your Caterpillar Dealer for additional information.

- Introduction
- Range Dimensions

Introduction

Caterpillar forestry machines are specifically designed for tough forest work. Each model uses purpose built booms and sticks designed by Caterpillar for maximum performance and durability.

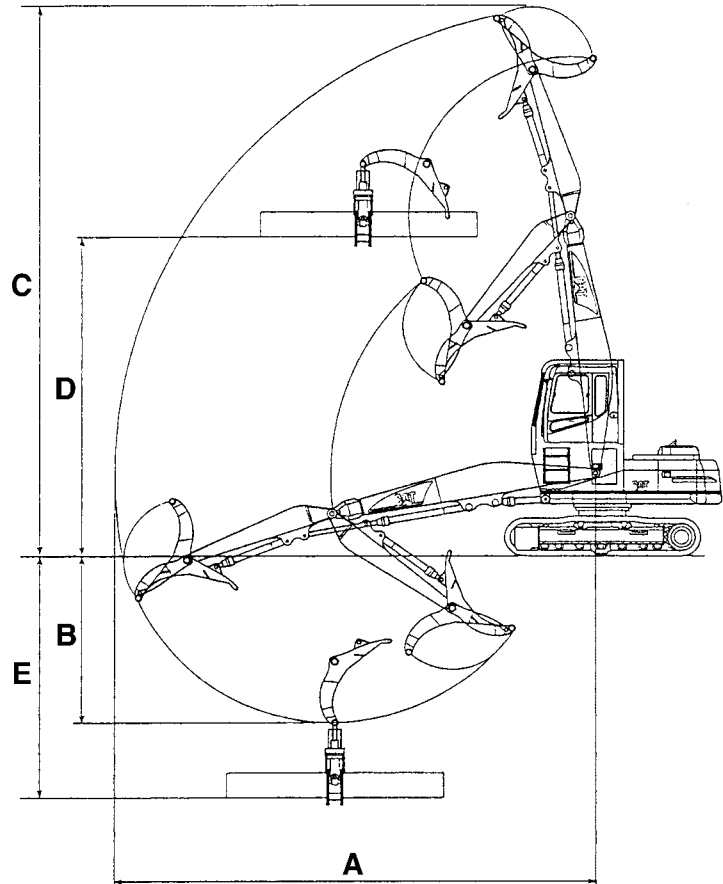

Working Envelope

	320B FM w/high wide carbody		320B FM w/reinforced carbody	
	m	ft	m	ft
A Max. Reach	10.98	36'0"	10.98	36'0"
B Max. Deck Height	4	13'1"	4.17	13'8"
C Max. Height	12.63	41'5"	12.46	40'10"
D Max. Deck Depth	7.37	24'2"	7.20	23'7"
E Max. Deck Depth	5.68	18'8"	5.85	19'2"

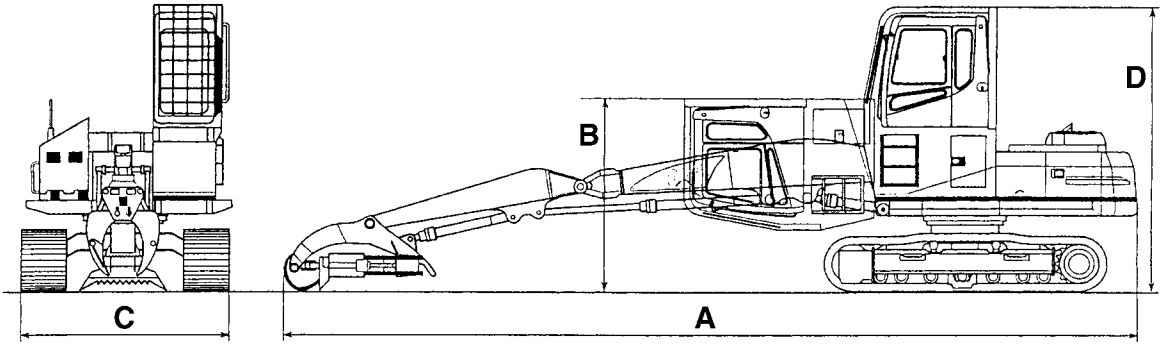

Shipping Dimensions

	320B FM w/high wide carbody 1.22 m (4'0") cab riser		320B FM w/high wide carbody 457 mm (18") cab riser		320B FM w/reinforced carbody 1.22 m (4'0") cab riser		320B FM w/reinforced carbody 457 mm (18") cab riser	
	m	ft	m	ft	m	ft	m	ft
A Overall Length	13.62	44'8"	13.62	44'8"	13.62	44'8"	13.62	44'8"
B Overall Height	3.11	10'3"	3.66	12'0"	2.94	9'8"	3.49	11'5"
C Overall Width	3.31	10'10"	3.31	10'10"	3.26	10'8"	3.26	10'8"
D Cab Height	4.55	14'11"	3.79	12'5"	4.38	14'5"	3.62	11'11"

Forest Machine	320B FM	
	kg	lb
Booms*		
Reach	2020	4450
Mass	2050	4520
LL Boom	2610	5750
Sticks** (for Reach)		
Short	750	1650
•	650	1430
•	675	1490
Long	750	1650
Sticks (for Mass)		
Short	750	1650
•	780	1720
Long	—	—
Sticks (for LL Boom)		
LL Stick	905	2000
Upperstructure (complete w/o counterweight)		
w/1.22 m (4'0") cab riser	7400	16,310
w/457 mm (18") cab riser	7180	15,830
Undercarriage (for high wide carbody)		
— 600 mm (2'0") shoe	8850	19,510
— 700 mm (2'4") shoe	9175	20,230
— 800 mm (2'7") shoe	9165	20,210
Undercarriage (reinforced carbody)		
— 600 mm (2'0") shoe	8390	18,500
— 700 mm (2'4") shoe	8710	19,200
— 800 mm (2'7") shoe	8700	19,180
Counterweight — Standard	3865	8520
— Heavy	5830	12,850

*Boom weights include boom, boom lines, boom cylinders and rod end pins, stick cylinder and head end pin.

**Stick weights include stick and stick lines.

LIFT AND RANGE DIAGRAM

320B Log Loader

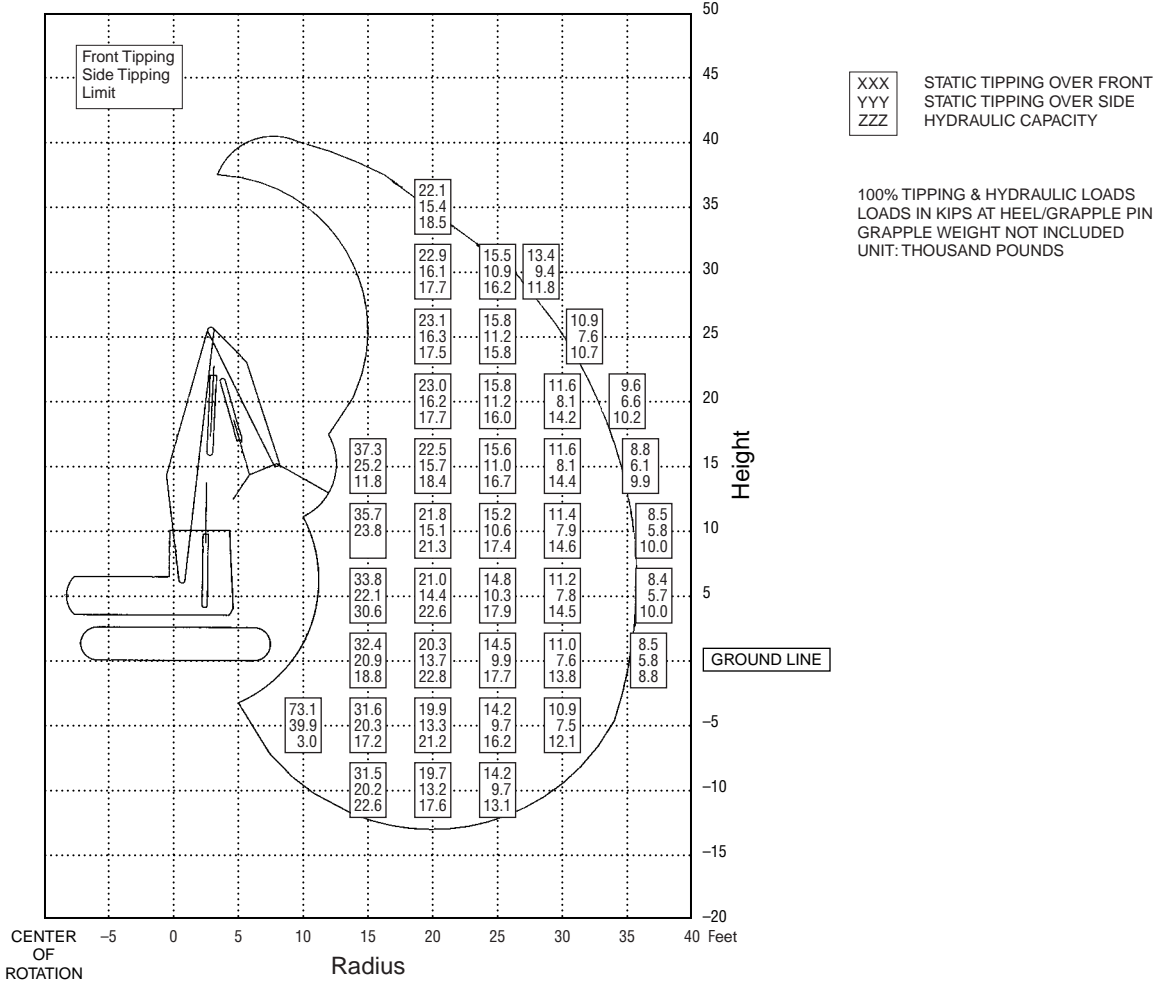

- Undercarriage — long
- Logging Front — Caterpillar 320B LL HB-36, 10 970 mm (36'0") maximum reach
- Capacity, lbs., (thousands)
 - Top Number: Tipping over front
 - Middle Number: Tipping over side
 - Bottom Number: Hydraulic capacity

- All capacities are 100% stability and 100% hydraulic with no deration for friction (100% efficiency)
 - Grapple weight is not included
- Calculations, weights and machine specifications are subject to change at any time without notice.

LIFT AND RANGE DIAGRAM

322B High Wide Forest Machine — Under/Under

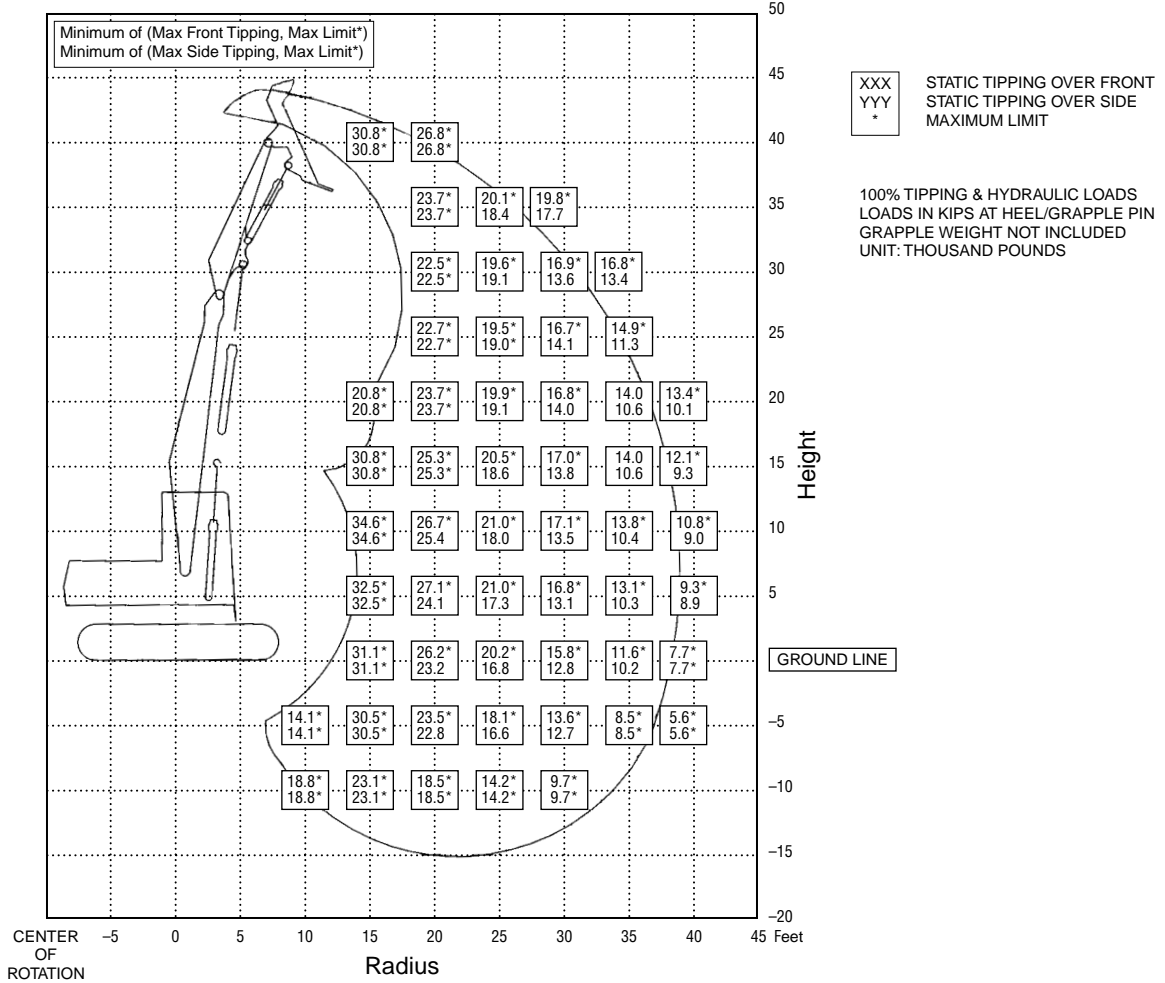

- Undercarriage — long, extended gauge
- Logging Front — Caterpillar 322B LL Under-Under Log Loader, 11 580 mm (38'0") maximum reach
- Capacity, lbs., (thousands)
 Top Number: Tipping over front
 Middle Number: Tipping over side
 Bottom Number: Hydraulic capacity

- All capacities are 100% stability and 100% hydraulic with no deration for friction (100% efficiency)
 - Grapple weight is not included
- Calculations, weights and machine specifications are subject to change at any time without notice.

LIFT AND RANGE DIAGRAM

322B High Wide Forest Machine — Over/Under

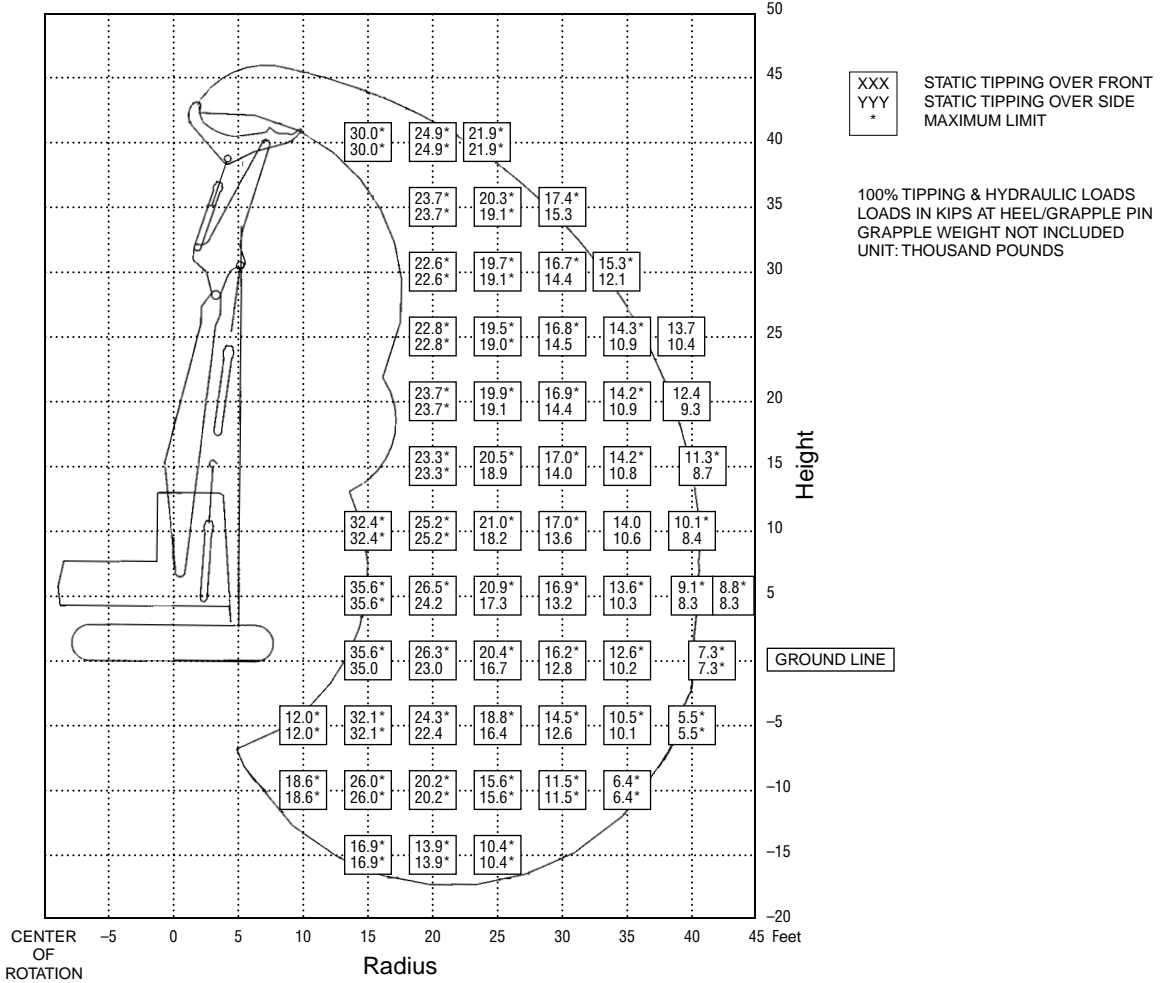

- Undercarriage — long, extended gauge
- Logging Front — Caterpillar 322B LL Over-Under Log Loader, 12 500 mm (41'0") maximum reach
- Capacity, lbs., (thousands)
 Top Number: Tipping over front
 Middle Number: Tipping over side
 Bottom Number: Hydraulic capacity

- All capacities are 100% stability and 100% hydraulic with no deration for friction (100% efficiency)
 - Grapple weight is not included
- Calculations, weights and machine specifications are subject to change at any time without notice.

LIFT AND RANGE DIAGRAM

322B High Wide Forest Machine — B-N-T

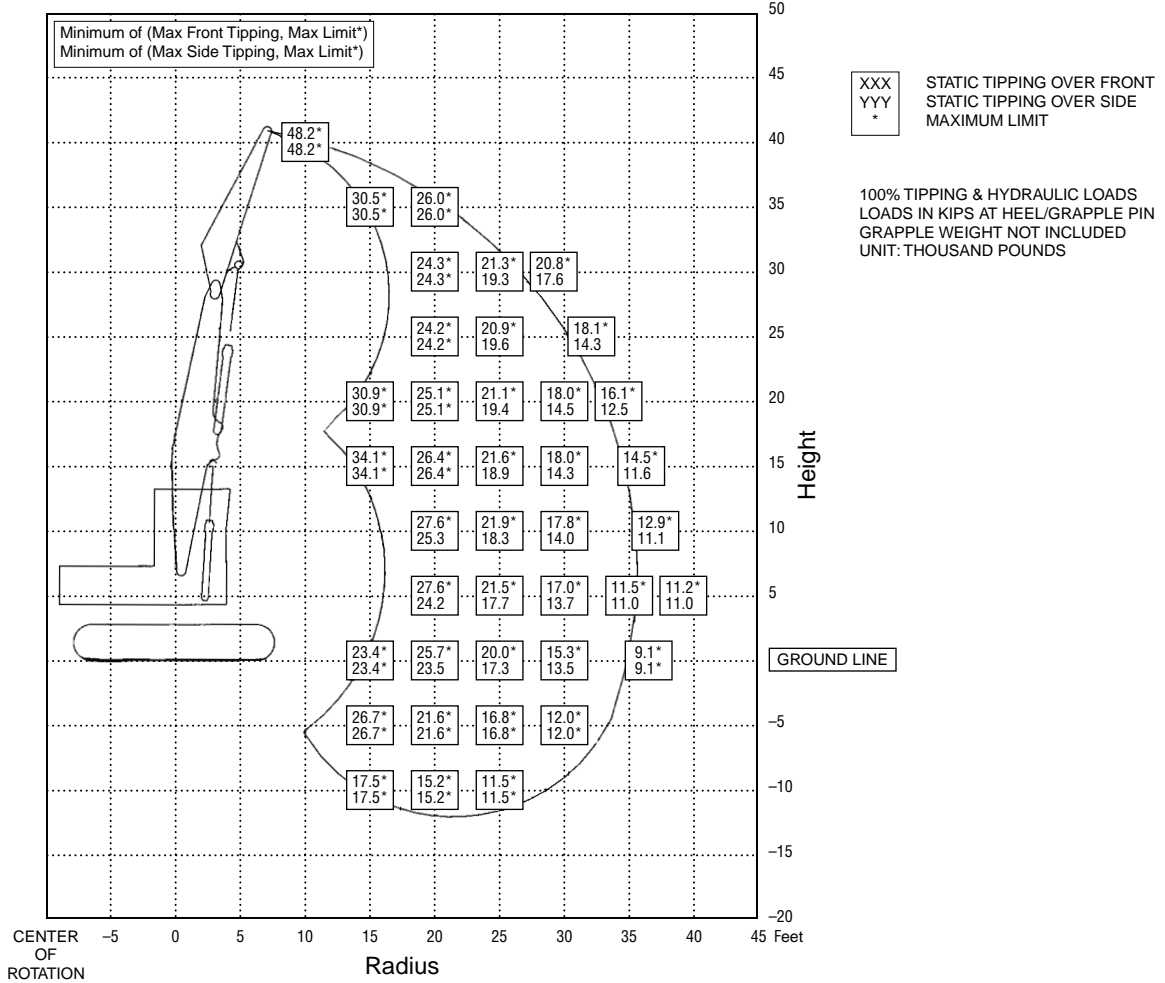

- Undercarriage — long, extended gauge
- Logging Front — Caterpillar 322B LL Butt-N-Top Log Loader, 10 970 mm (36'0") maximum reach
- Capacity, lbs., (thousands)
 Top Number: Tipping over front
 Middle Number: Tipping over side
 Bottom Number: Hydraulic capacity

- All capacities are 100% stability and 100% hydraulic with no deration for friction (100% efficiency)
 - Grapple weight is not included
- Calculations, weights and machine specifications are subject to change at any time without notice.

LIFT AND RANGE DIAGRAM

325B High Wide Forest Machine — Under/Under

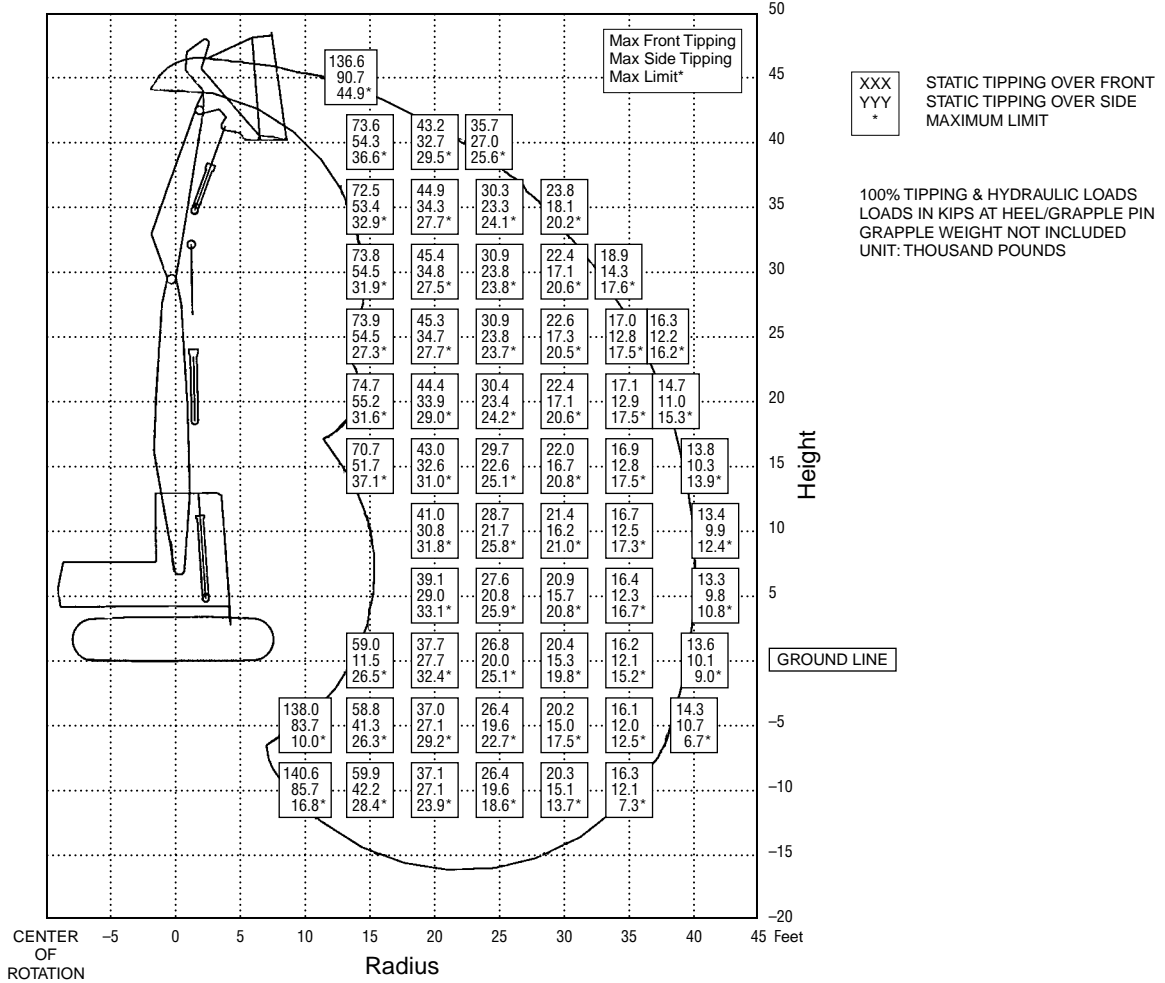

- Undercarriage — long, extended gauge
- Logging Front — Caterpillar 325B LL Under-Under Log Loader, 12 190 mm (40'0") maximum reach
- Capacity, lbs., (thousands)
 Top Number: Tipping over front
 Middle Number: Tipping over side
 Bottom Number: Hydraulic capacity

- All capacities are 100% stability and 100% hydraulic with no deration for friction (100% efficiency)
 - Grapple weight is not included
- Calculations, weights and machine specifications are subject to change at any time without notice.

LIFT AND RANGE DIAGRAM

325B High Wide Forest Machine — Over/Under

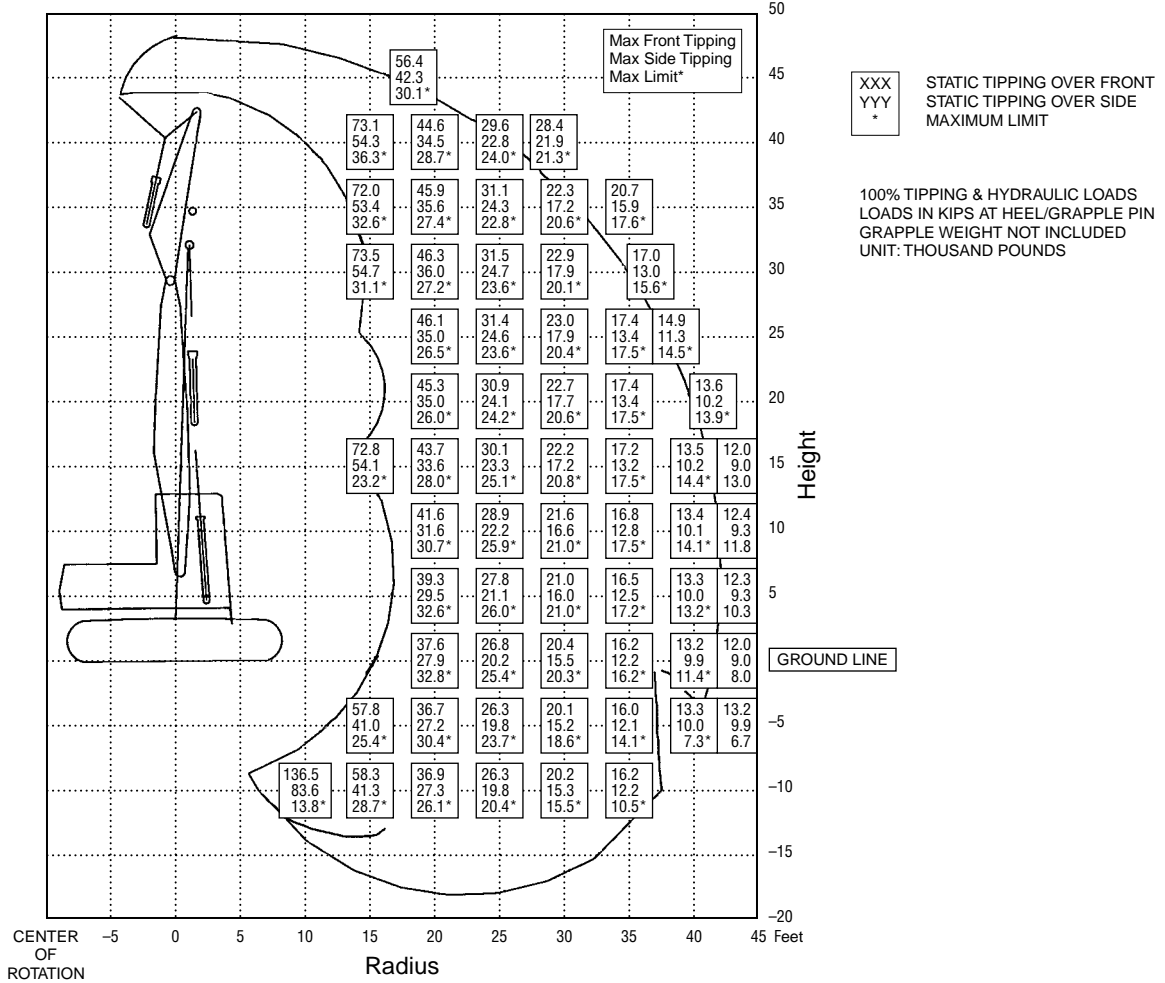

- Undercarriage — long, extended gauge
- Logging Front — Caterpillar 325B LL Over-Under Log Loader, 12 800 mm (42'0") maximum reach
- Capacity, lbs., (thousands)
 - Top Number: Tipping over front
 - Middle Number: Tipping over side
 - Bottom Number: Hydraulic capacity

- All capacities are 100% stability and 100% hydraulic with no deration for friction (100% efficiency)
- Grapple weight is not included

Calculations, weights and machine specifications are subject to change at any time without notice.

LIFT AND RANGE DIAGRAM

325B High Wide Forest Machine — B-N-T

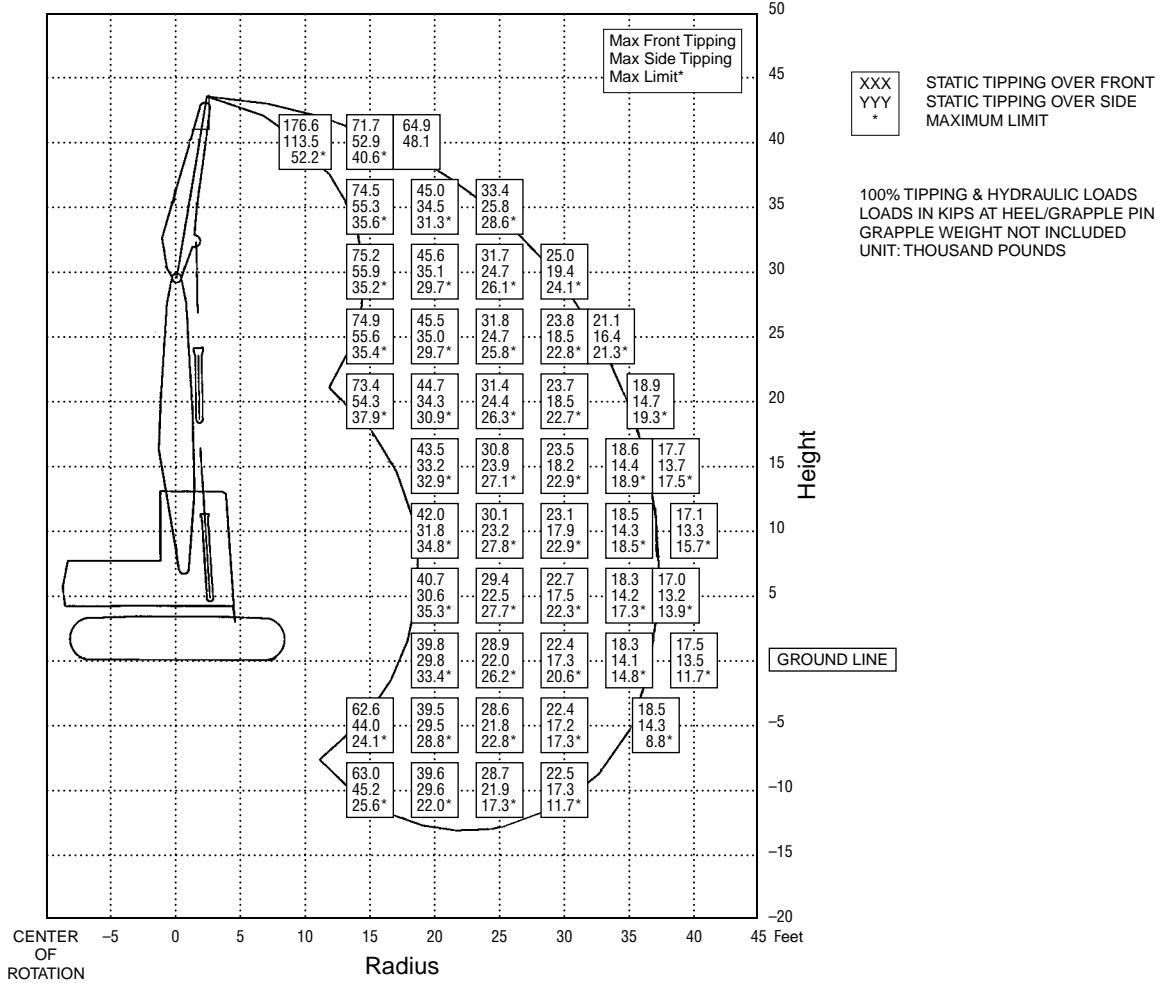

- Undercarriage — long, extended gauge
- Logging Front — Caterpillar 325B LL Butt-N-Top Log Loader, 11 280 mm (37'0") maximum reach
- Capacity, lbs., (thousands)
 Top Number: Tipping over front
 Middle Number: Tipping over side
 Bottom Number: Hydraulic capacity

- All capacities are 100% stability and 100% hydraulic with no deration for friction (100% efficiency)
 - Grapple weight is not included
- Calculations, weights and machine specifications are subject to change at any time without notice.

LIFT AND RANGE DIAGRAM

**325B High Wide Forest Machine
 with Hoist Cylinder Adapter**

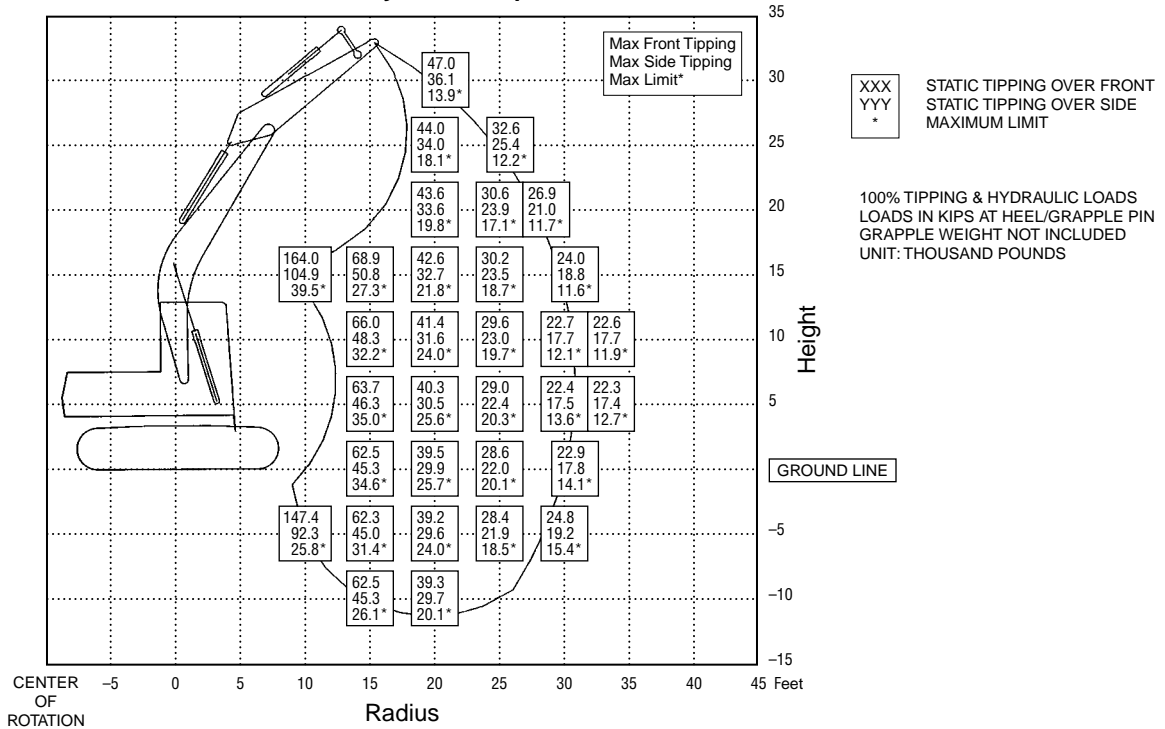

- Undercarriage — long, extended gauge
- Excavator Front — Caterpillar 325B LL with hoist cylinder adapter, heavy counterweight, R-Boom, R-Stick, 9450 mm (31'0") maximum reach
- Capacity, lbs., (thousands)
 - Top Number: Tipping over front
 - Middle Number: Tipping over side
 - Bottom Number: Hydraulic capacity

- All capacities are 100% stability and 100% hydraulic with no deration for friction (100% efficiency)
- Grapple weight is not included

Calculations, weights and machine specifications are subject to change at any time without notice.

LIFT AND RANGE DIAGRAM

**325B High Wide Forest Machine
without Hoist Cylinder Adapter**

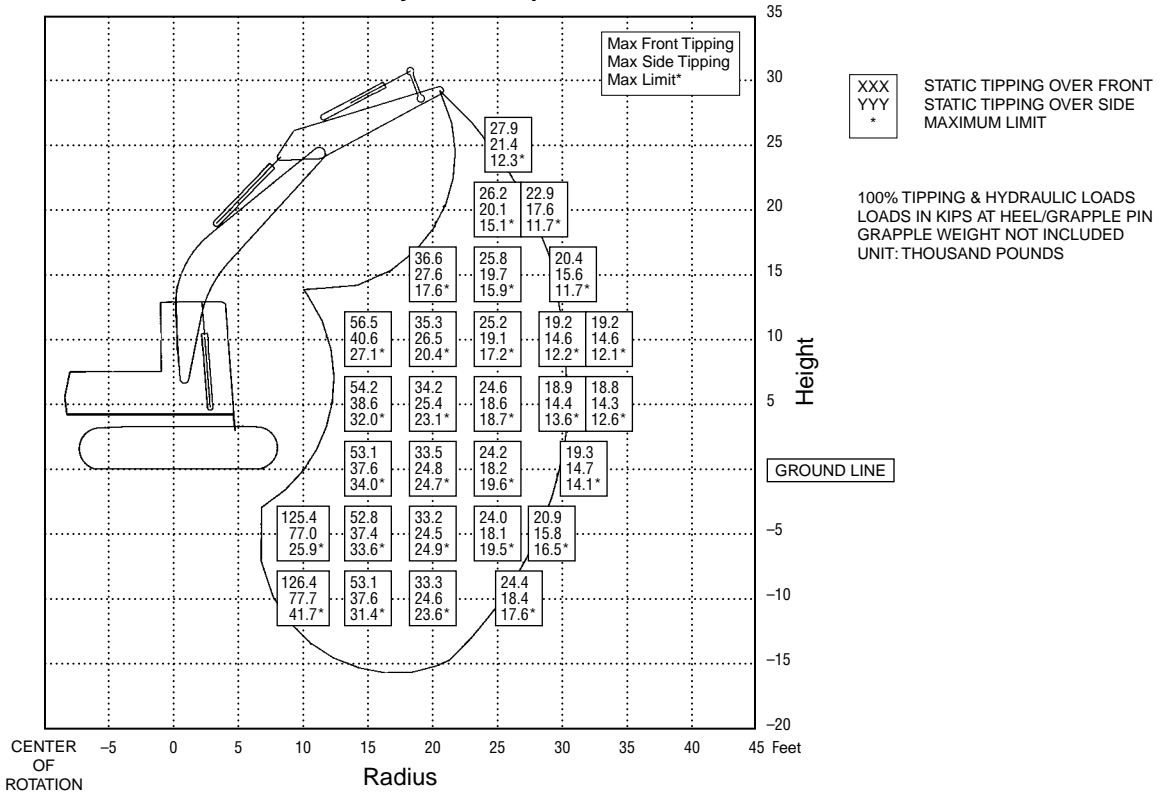

- Undercarriage — long, extended gauge
- Excavator Front — Caterpillar 325B LL without hoist cylinder adapter, R-Boom, R-Stick, 9300 mm (30'6") maximum reach
- Capacity, lbs., (thousands)
 - Top Number: Tipping over front
 - Middle Number: Tipping over side
 - Bottom Number: Hydraulic capacity

- All capacities are 100% stability and 100% hydraulic with no deration for friction (100% efficiency)
- Grapple weight is not included

Calculations, weights and machine specifications are subject to change at any time without notice.

LIFT AND RANGE DIAGRAM

**325B High Wide Forest Machine
with Hoist Cylinder Adapter**

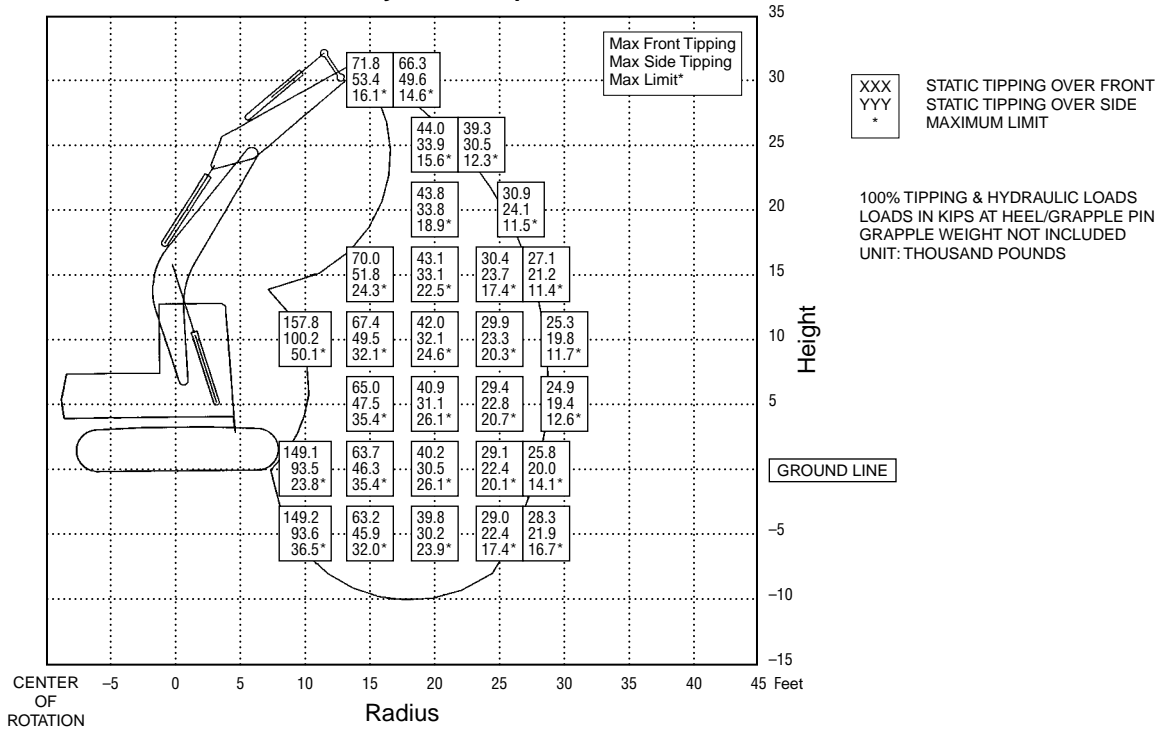

- Undercarriage — long, extended gauge
- Excavator Front — Caterpillar 325B LL with hoist cylinder adapter, heavy counterweight, M-Boom, R-Stick, 8530 mm (28'0") maximum reach
- Capacity, lbs., (thousands)
 Top Number: Tipping over front
 Middle Number: Tipping over side
 Bottom Number: Hydraulic capacity

- All capacities are 100% stability and 100% hydraulic with no deration for friction (100% efficiency)
- Grapple weight is not included

Calculations, weights and machine specifications are subject to change at any time without notice.

LIFT AND RANGE DIAGRAM

325B Standard Gauge Forest Machine
without Hoist Cylinder Adapter

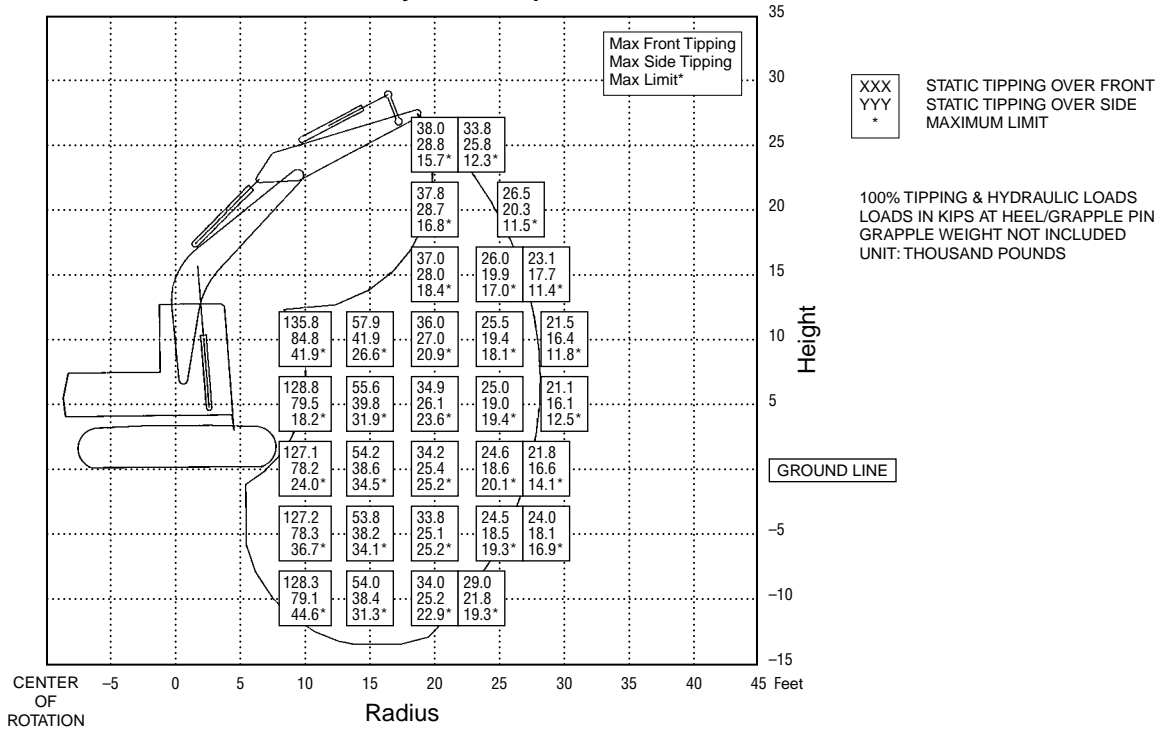

- Undercarriage — long, standard gauge
 - Excavator Front — Caterpillar 325B LL without hoist cylinder adapter, M-Boom, R-Stick, 8530 mm (28'0") maximum reach
 - Capacity, lbs., (thousands)
 - Top Number: Tipping over front
 - Middle Number: Tipping over side
 - Bottom Number: Hydraulic capacity
 - All capacities are 100% stability and 100% hydraulic with no deration for friction (100% efficiency)
 - Grapple weight is not included
- Calculations, weights and machine specifications are subject to change at any time without notice.

LIFT AND RANGE DIAGRAM

330B High Wide Forest Machine — Under/Under

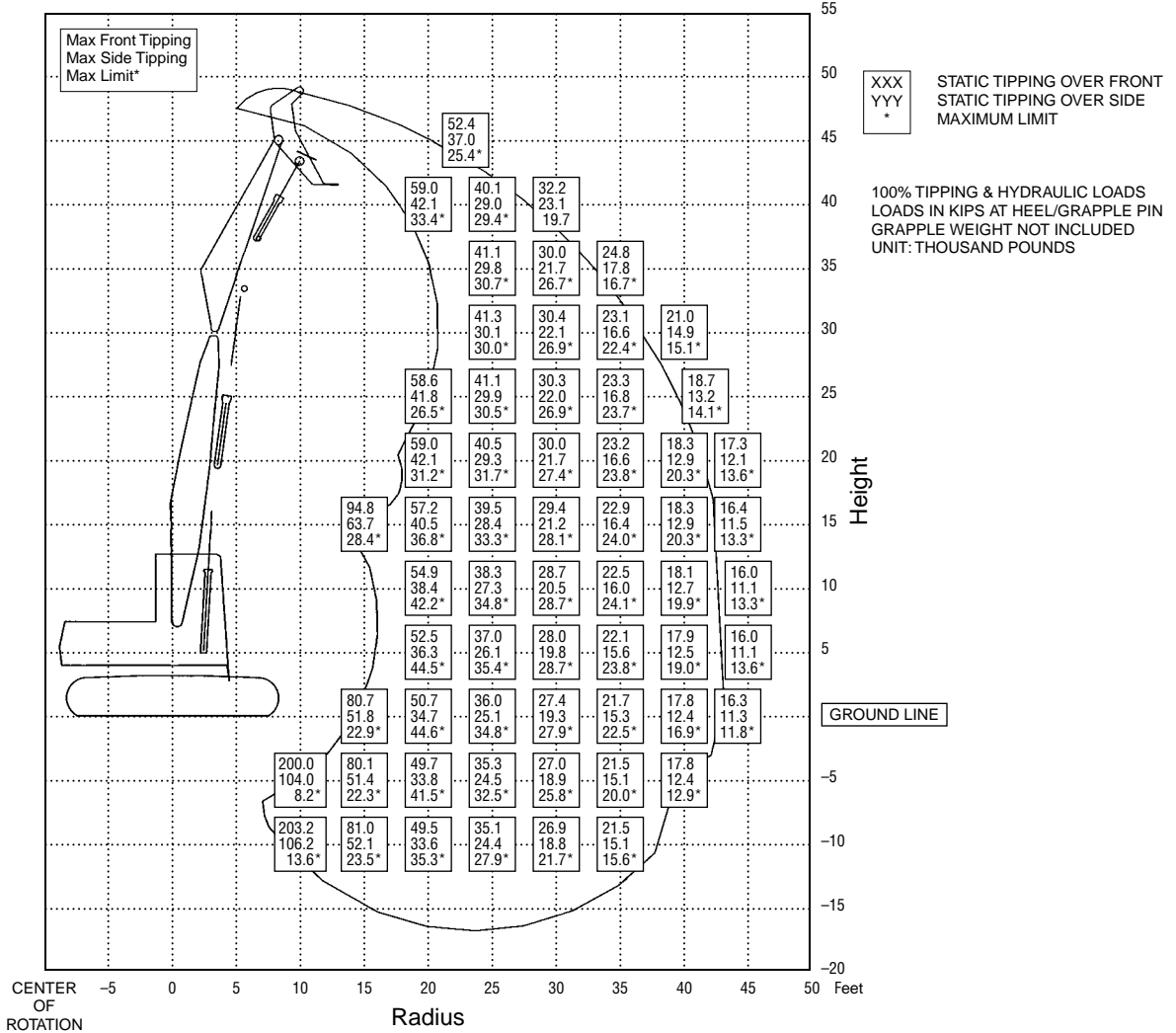

- Undercarriage — long, extended gauge
- Logging Front — Caterpillar 330B LL Under-Under Log Loader, 13 100 mm (4'3") maximum reach
- Capacity, lbs., (thousands)
 Top Number: Tipping over front
 Middle Number: Tipping over side
 Bottom Number: Hydraulic capacity

- All capacities are 100% stability and 100% hydraulic with no deration for friction (100% efficiency)
 - Grapple weight is not included
- Calculations, weights and machine specifications are subject to change at any time without notice.

LIFT AND RANGE DIAGRAM

330B High Wide Forest Machine — Over/Under

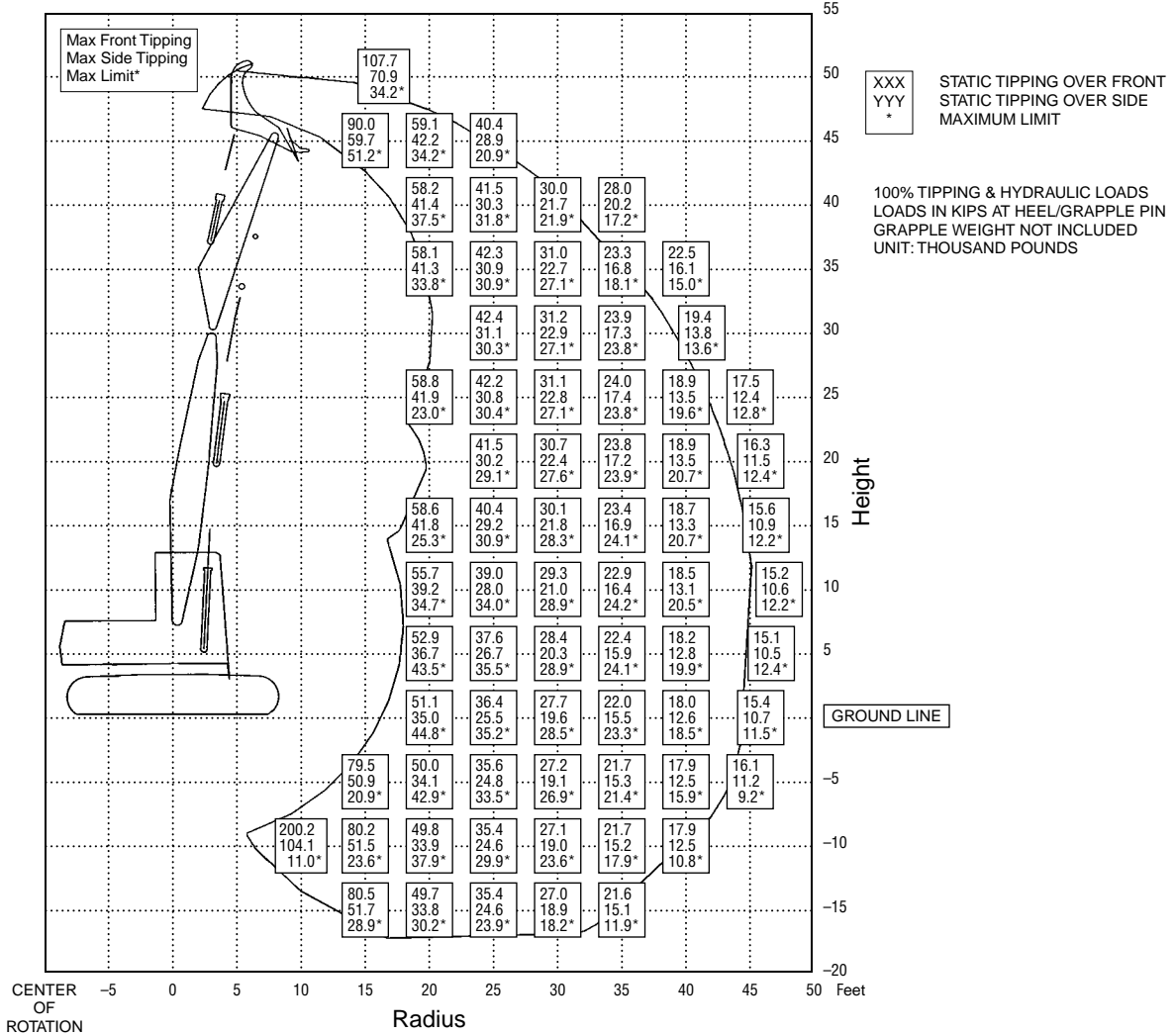

- Undercarriage — long, extended gauge
- Logging Front — Caterpillar 330B LL Over-Under Log Loader, 13 700 mm (45'0") maximum reach
- Capacity, lbs., (thousands)
 Top Number: Tipping over front
 Middle Number: Tipping over side
 Bottom Number: Hydraulic capacity

- All capacities are 100% stability and 100% hydraulic with no deration for friction (100% efficiency)
- Grapple weight is not included

Calculations, weights and machine specifications are subject to change at any time without notice.

LIFT AND RANGE DIAGRAM
330B High Wide Forest Machine — B-N-T

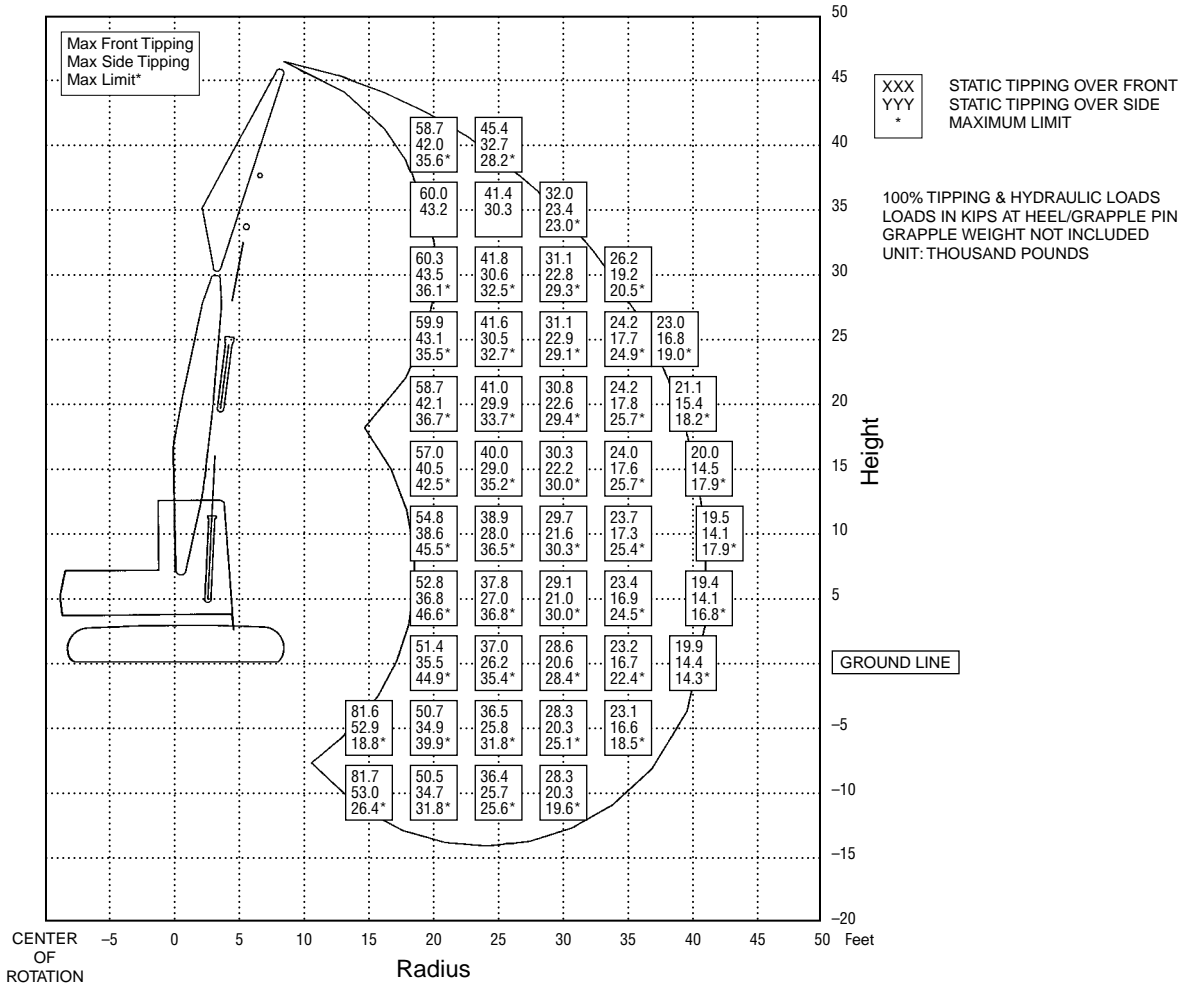

- Undercarriage — long, extended gauge
- Logging Front — Caterpillar 330B LL Butt-N-Top Log Loader, 12 190 mm (40'0") maximum reach
- Capacity, lbs., (thousands)
 Top Number: Tipping over front
 Middle Number: Tipping over side
 Bottom Number: Hydraulic capacity

- All capacities are 100% stability and 100% hydraulic with no deration for friction (100% efficiency)
- Grapple weight is not included

Calculations, weights and machine specifications are subject to change at any time without notice.

LIFT AND RANGE DIAGRAM

330B High Wide Forest Machine
with Hoist Cylinder Adapter

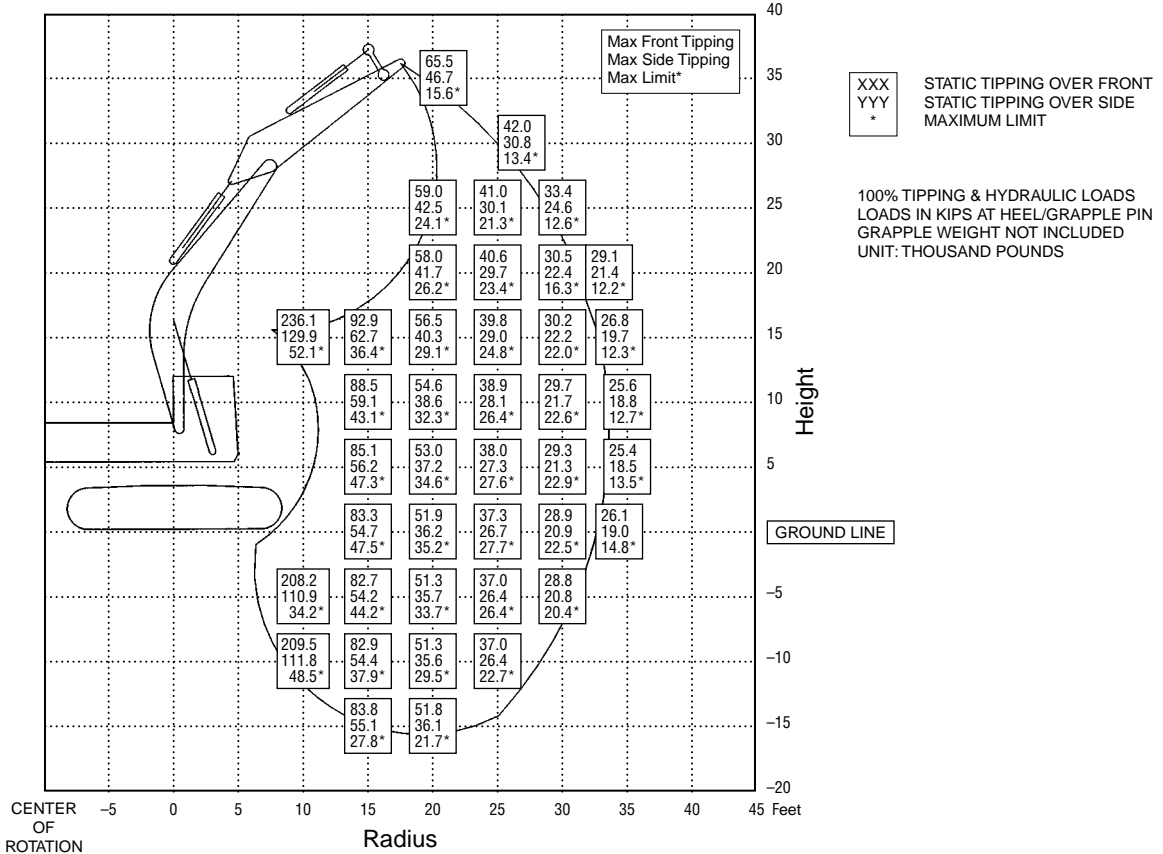

- Undercarriage — long, extended gauge
- Excavator Front — Caterpillar 330B LL with hoist cylinder adapter, R-Boom, R-Stick, 10 100 mm (33'0") maximum reach
- Capacity, lbs., (thousands)
 Top Number: Tipping over front
 Middle Number: Tipping over side
 Bottom Number: Hydraulic capacity

- All capacities are 100% stability and 100% hydraulic with no deration for friction (100% efficiency)
- Grapple weight is not included

Calculations, weights and machine specifications are subject to change at any time without notice.

LIFT AND RANGE DIAGRAM

**330B High Wide Forest Machine
 without Hoist Cylinder Adapter**

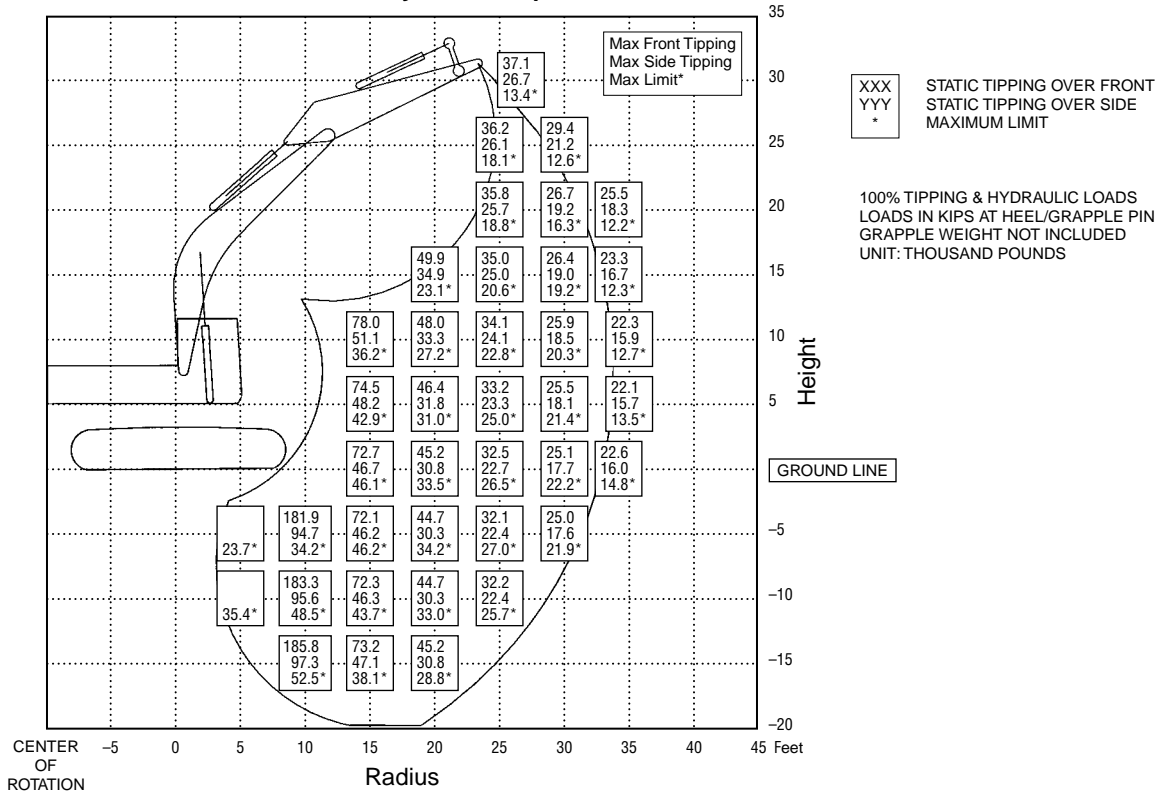

- Undercarriage — long, extended gauge
- Excavator Front — Caterpillar 330B LL without hoist cylinder adapter, 10 100 mm (33'0") maximum reach
- Capacity, lbs., (thousands)
 Top Number: Tipping over front
 Middle Number: Tipping over side
 Bottom Number: Hydraulic capacity

- All capacities are 100% stability and 100% hydraulic with no deration for friction (100% efficiency)
- Grapple weight is not included

Calculations, weights and machine specifications are subject to change at any time without notice.

LIFT AND RANGE DIAGRAM

**330B High Wide Forest Machine
with Hoist Cylinder Adapter**

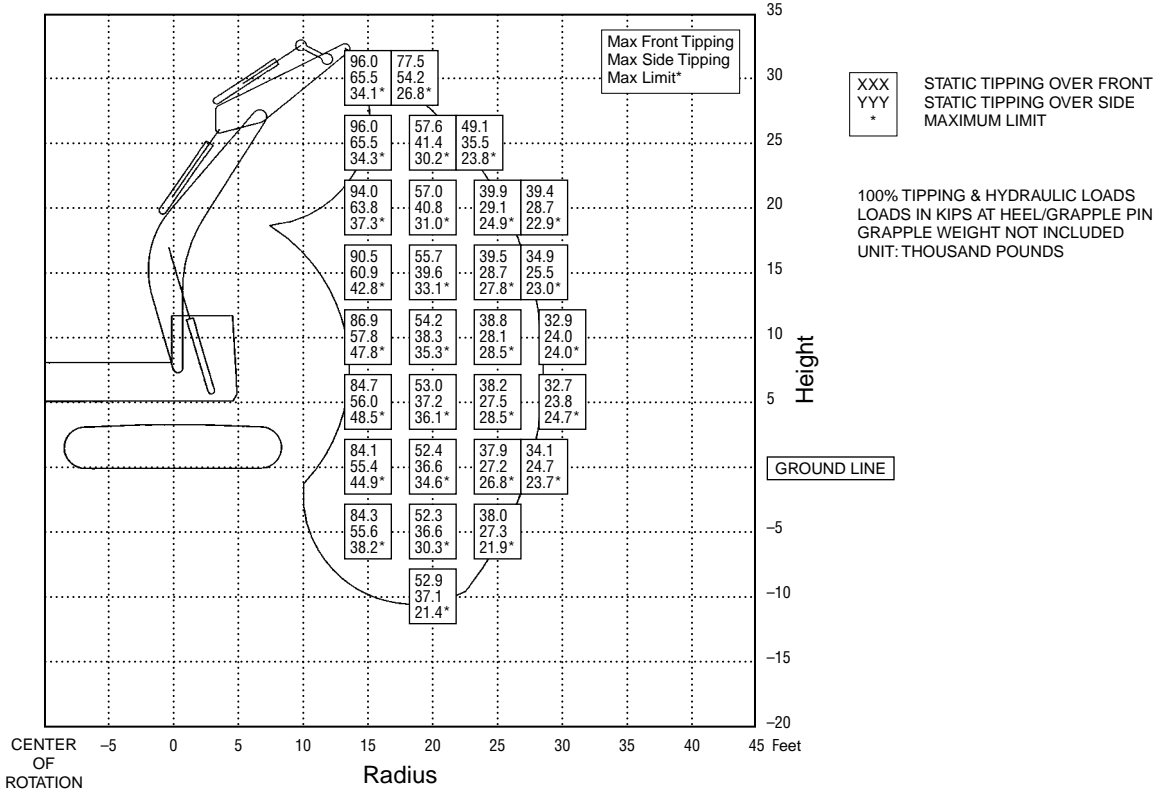

- Undercarriage — long, extended gauge
- Excavator Front — Caterpillar 330B LL with hoist cylinder adapter, heavy counterweight, M-Boom, M-Stick, 8530 mm (28'0") maximum reach
- Capacity, lbs., (thousands)
 - Top Number: Tipping over front
 - Middle Number: Tipping over side
 - Bottom Number: Hydraulic capacity

- All capacities are 100% stability and 100% hydraulic with no deration for friction (100% efficiency)
- Grapple weight is not included

Calculations, weights and machine specifications are subject to change at any time without notice.

LIFT AND RANGE DIAGRAM
330B Forest Machine
without Hoist Cylinder Adapter

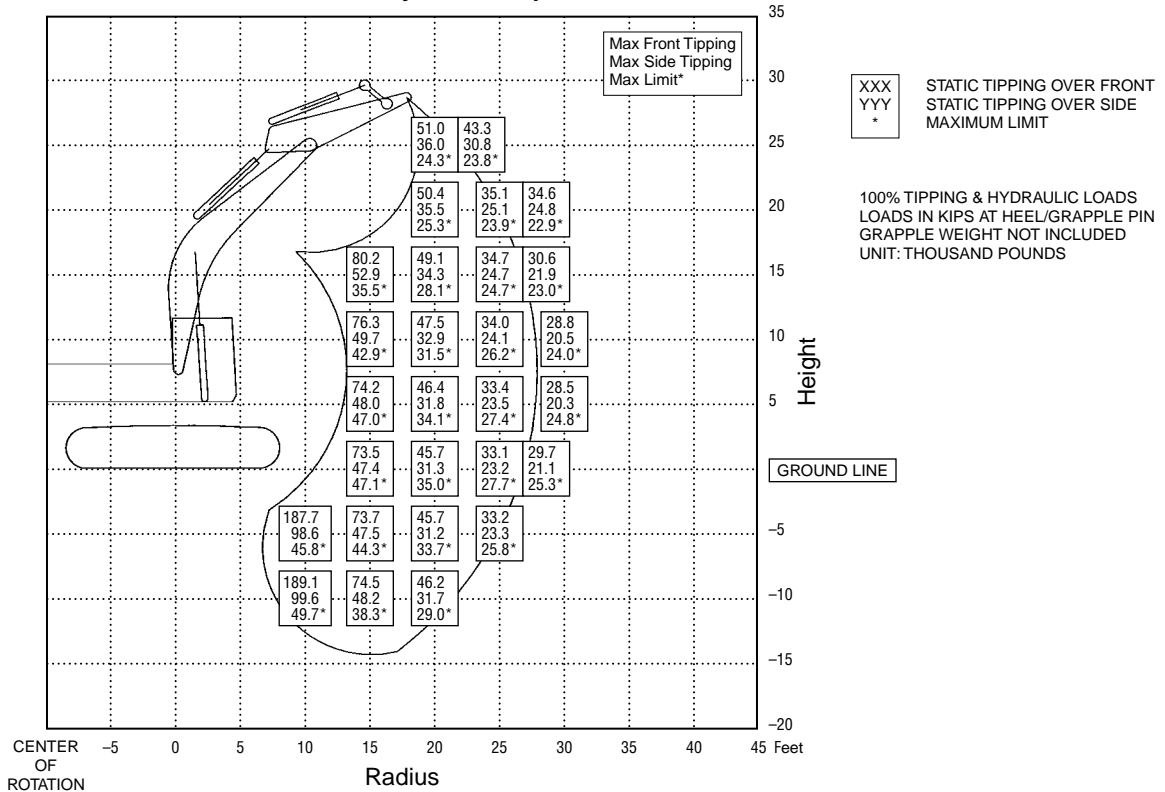

- Undercarriage — long, standard gauge
- Excavator Front — Caterpillar 330B LL without hoist cylinder adapter, M-Boom, M-Stick, 8530 mm (28'0") maximum reach
- Capacity, lbs., (thousands)
 - Top Number: Tipping over front
 - Middle Number: Tipping over side
 - Bottom Number: Hydraulic capacity

- All capacities are 100% stability and 100% hydraulic with no deration for friction (100% efficiency)
- Grapple weight is not included

Calculations, weights and machine specifications are subject to change at any time without notice.

Features:

- **Full 360° continuous rotation.**
- **Applicable to shovel logging and sorting applications.**
- **Paddle style tines** are made of abrasion resistant material.
- **Induction hardened pins and bushings.**
- **Heavy well hydraulic cylinders** with large diameter rod and integral load check valves.

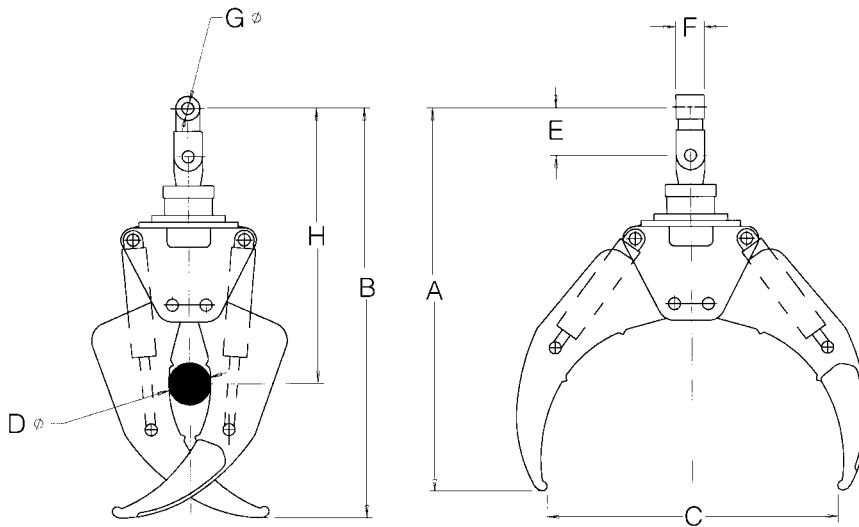

Dimensions:

Grapple Model		A	B	C	D	E	F	G	H
B52 (320B LL/322B LL)	mm	1854	2006	1372	195	254	152	63	1371
	in	73	79	54	7.7	10	6	2.5	54
B60 (325B LL/330B LL)	mm	2032	2160	1524	218	254	152	63	1448
	in	80	85	60	8.6	10	6	2.5	57

WHEEL TRACTOR MODEL	814F		824G		834B	
Balderson Models	BD814US-14'		BD824US-15'9"		BD834US-20'	
Replaces "S" Blade						
Blade:						
Capacity	16.74 m ³	21.9 yd³	24 m ³	31.4 yd³	29.8 m ³	39 yd³
Length (cutting width)	4.3 m	14'4"	4.78 m	15'7"	6.09 m	20'0"
Height	1.88 m	6'2"	2.24 m	7'4"	2.24 m	7'4"
Wing angle	25°		30°		30°	
Weight, Installed (without hydraulics)						
BD (S) Dozer	1973 kg	4350 lb	3630 kg	8000 lb	4627 kg	9470 lb

WHEEL TRACTOR MODEL	814F		824G		834B	
Balderson Models	B14-20S		B24-27S		B34-40S	
Replaces "S" Blade						
Chip Scoop:						
Lift and Carrying Capacity	15.3 m ³	20 yd³	20.6 m ³	27 yd³	34.4 m ³	39.5 yd³
Dozing Capacity	30.4 m ³	40 yd³	41.3 m ³	54 yd³	49.4 m ³	65 yd³
Width	3.73 m	12'3"	4.03 m	13'3"	4.83 m	15'10"
Height	2.29 m	7'6"	2.79 m	9'2"	2.25 m	7'4"
Depth	2.46 m	8'1"	2.95 m	9'8"	3.02 m	9'11"
Weight	5390 kg	11,880 lb	11 420 kg	19,125 lb	11 105 kg	24,480 lb

NOTE: For specifications of Woodchip Dozers used on track-type tractors, see the Bulldozer section in this handbook.

SPECIFICATIONS

Excavator Model	325B FB	
Balderson Model	BFS325II	
Saw Disc		
Blade diameter	1397 mm	4'7"
Weight	320 kg	700 lb
Saw kerf	51 mm	2"
Blade speed	1250 RPM	

Replaceable carbide inserts for teeth and rakers

Features:

- **Dual Motion Stroking Action.** Rear grapple moves the tree to the rear while the boom strokes forward.
- **Full 12 m (40'0") delimiting stroke** with tail swing limited to 5.6 m (18'6").
- **Unique dual motion design** keeps tree stem weight and delimiting machine close to swing centerline.
- **Balanced loading** allows mounting on a smaller carrier than is required for conventional delimiters.
- **Simple conversion** from shipping to working mode. One person can do the conversion using only 2 wrenches in 10-15 minutes.

MODEL

320B

MODEL	320B	
Carrier	320B Forest Machine	
Stroke Length	12.19 m	40'0"
Max. Tree Diameter: @ Rear Grapple	660 mm	2'2"
Through Center Arch	1168 mm	3'10"
Tail Swing	5.64 m	18'6"
Drive Type	Hydraulic Cylinder	
Boom Speed m/min ft/min	198-251	650-825
Delimb Stroke Force	71.2 kN	16,000 lb
Pulling Force	57.4 kN	12,900 lb
Lift Capacity @ 11.6 m (38'0")	1089 kg	2400 lb
Topping Saw Capacity		
Circular Saw	381 mm	15"
Chain Saw	533 mm	1'9"
Butt Saw Capacity	609 mm	2'0"
	711 mm	2'4"
Delimber Attachment Weight	9935 kg	21,900 lb
Max. Total Package Weight (all options installed)	30 390 kg	67,000 lb

24

Shipping Dimensions:

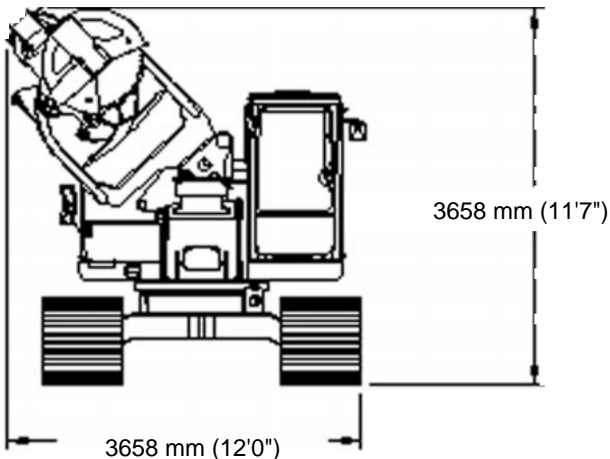

Working Dimensions:

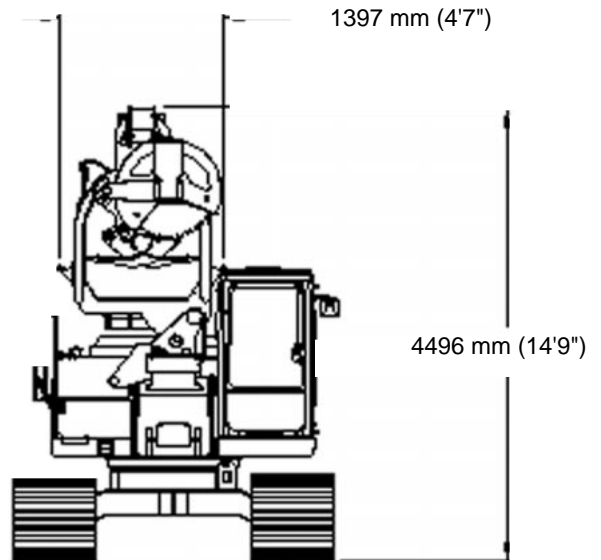

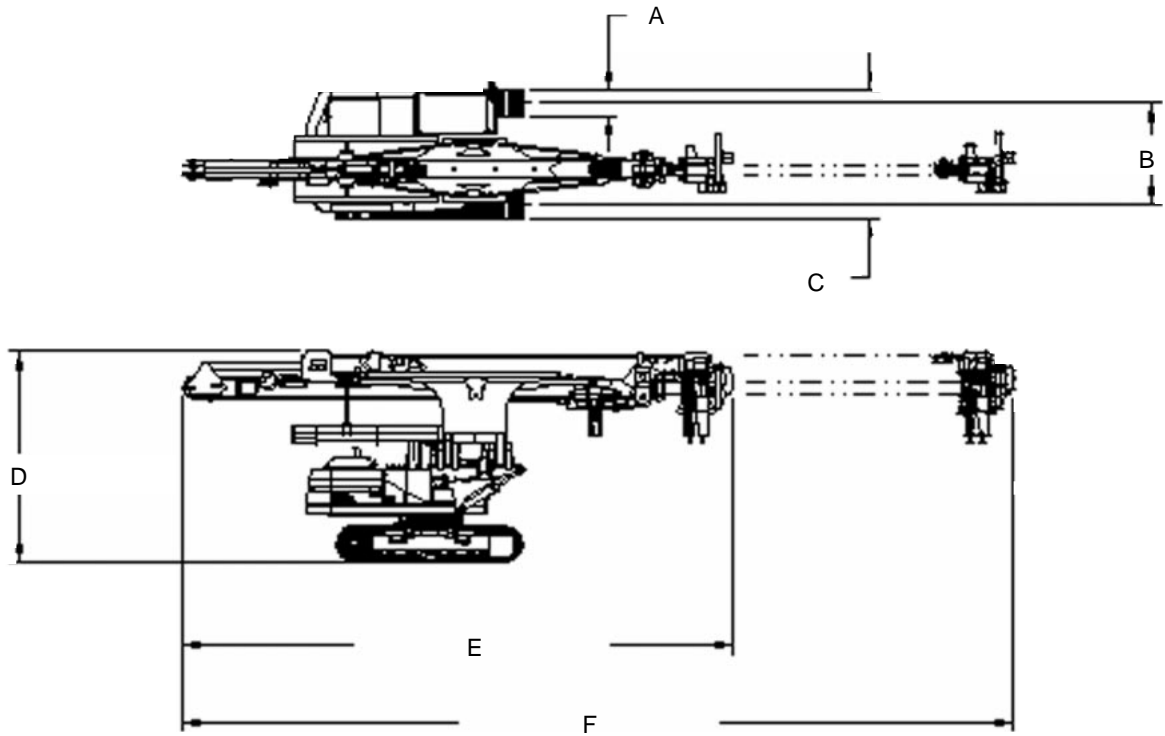

A		B		C		D		E		F	
813 mm	2'8"	2.4 m	7'10"	3.2 m	10'6"	4.6 m	15'1"	11.96 m	39'3"	18.06 m*	59'3"

*Maximum stroke position.

320B Stroke Delimber
 ● Working Range

Logging and Forest Products

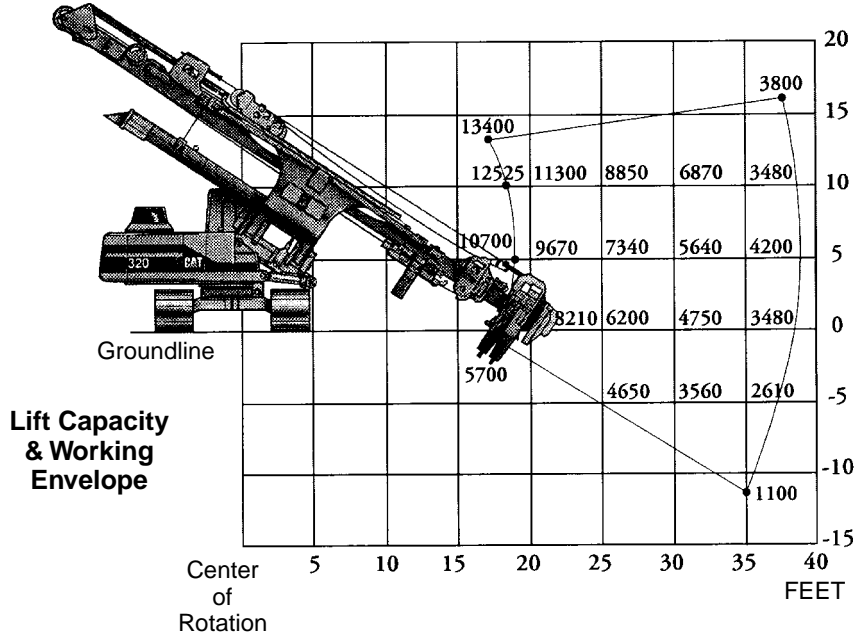

- 990 ● 988F ● 980G
- 966F Series II

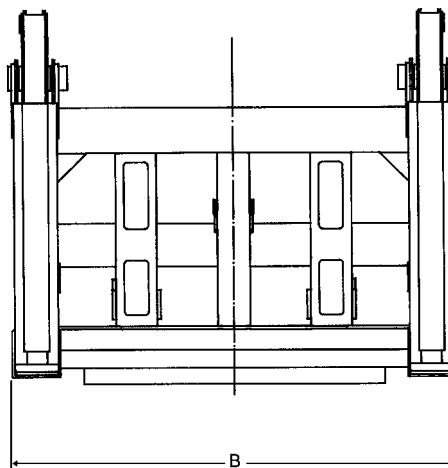
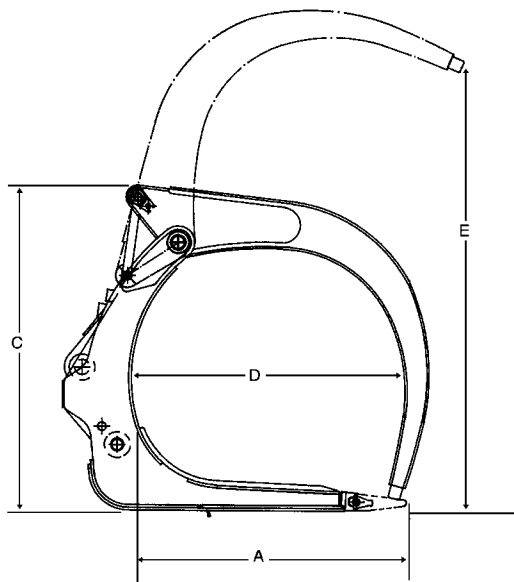

Caterpillar Model	990		988F		988F		980G	
Balderson Model	High Capacity Logging Fork		BFHC988DTC		BLF988DTC		BLF980DTC	
Group Number	114-3557		8966		8965		125-4135	
Logging Arrangement	114-3557		8966		8965		125-4135	
Bucket Arrangement	—		—		8965*		9210	
A — Tine Length	2438 mm	8'0"	2286 mm	7'6"	2286 mm	7'6"	1829 mm	6'0"
B — Overall Width	2762 mm	9'1"	2743 mm	9'0"	2775 mm	9'1"	2756 mm	9'2"
C — Back Height	3670 mm	12'0"	3505 mm	11'6"	2974 mm	9'9.1"	2040 mm	6'8.3"
D — Minimum Opening	2498 mm	8'2"	2540 mm	8'4"	2370 mm	7'9.3"	1828 mm	5'11.95"
E — Maximum Clamp Opening	4529 mm	14'10"	4598 mm	15'0.9"	3713 mm	12'2.2"	2990 mm	9'9"
Weight, Approximate	4930 kg	10,870 lb	5350 kg	11,800 lb	4490 kg	9400 lb	3175 kg	7000 lb

Caterpillar Model	980G		966F Series II		966F Series II	
Balderson Model	Millyard Fork		BLF966DTC		Millyard Fork	
Group Number	133-1545		9209		5831C	
Logging Arrangement	133-1545		9209		5831C	
Bucket Arrangement	—		9209		—	
A — Tine Length	1829 mm	6'0"	1600 mm	5'3"	1651 mm	5'5"
B — Overall Width	2388 mm	7'10"	2362 mm	7'9"	2388 mm	7'10"
C — Back Height	2070 mm	6'10"	1899 mm	6'2.75"	1905 mm	6'3"
D — Minimum Opening	254 mm	10"	1624 mm	5'3.95"	432 mm	17"
E — Maximum Clamp Opening	2746 mm	9'0"	2539 mm	8'3.95"	2642 mm	8'8"
Weight, Approximate	2742 kg	5450 lb	2360 kg	5200 lb	2450 kg	5400 lb

*BLF988DTC with bucket arrangement — must order Balderson Link Assembly #137519.

NOTE: Third valve required. Counterweight recommended.

Logging forks with millyard style clamps are available where logging application requires clamp to close between tines. Contact your Caterpillar Dealer or Balderson for more information.

- Logging Forks
 ● 966C ● 950G ● 962G ● 938G
 ● IT38G ● 950 Series II Custom Toolcarrier

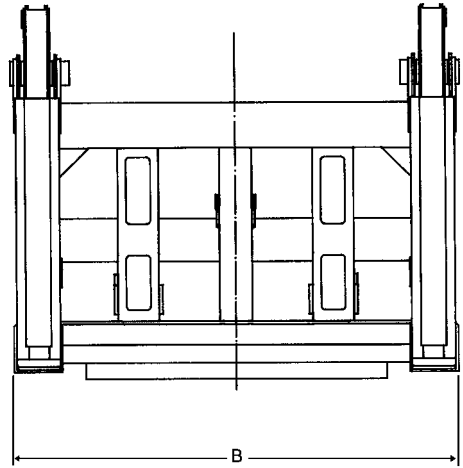
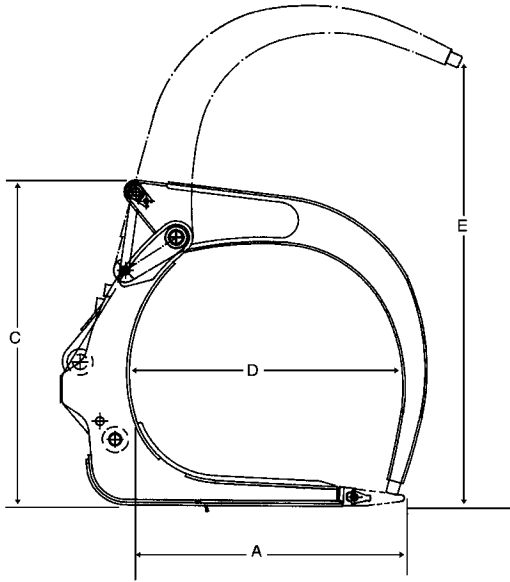

Caterpillar Model	966C	950G/962G	950G/962G	938G
Balderson Model	BLF966DTC	BLF950DTC	Millyard Fork	Millyard Fork
Group Number				
Logging Arrangement	8963	157-3467	157-3466	119-8243
Bucket Arrangement	8963			
A — Tine Length	1448 mm 4'9"	1626 mm 5'4"	1626 mm 5'4"	1372 mm 4'6"
B — Overall Width	2362 mm 7'9"	2261 mm 7'5"	2261 mm 7'5"	2288 mm 7'6"
C — Back Height	1822 mm 5'11.75"	1895 mm 6'2.59"	1890 mm 6'2.42"	1842 mm 6'1"
D — Minimum Opening	1359 mm 4'5.5"	1328 mm 4'4.27"	448 mm 17.64"	165 mm 6.5"
E — Maximum Clamp Opening	2500 mm 8'2.45"	2565 mm 8'5"	2913 mm 9'6.7"	2794 mm 9'2"
Weight, Approximate	2155 kg 4750 lb	2200 kg 4860 lb	2310 kg 5100 lb	1633 kg 3600 lb

Caterpillar Model	IT38G	IT38G	950F Series II Custom Toolcarrier	950F Series II Custom Toolcarrier
Balderson Model	Grapple Fork	Millyard Fork	Grapple Fork	Log & Lumber Fork
Group Number				
Logging Arrangement	119-2297	125-2607	119-2301	114-3532
Bucket Arrangement				
A — Tine Length	1056 mm 3'6"	1372 mm 4'6"	1158 mm 3'10"	1219 mm 4'0"
B — Overall Width	1637 mm 5'4"	2286 mm 7'6"	1702 mm 5'7"	2134 mm 7'0"
C — Back Height	1905 mm 6'3"	1902 mm 6'3"	2095 mm 6'10"	1859 mm 6'1"
D — Minimum Opening	1029 mm 3'4"	165 mm 6.5"	1024 mm 3'4"	339 mm 14"
E — Maximum Clamp Opening	2595 mm 8'6"	2845 mm 9'4"	2927 mm 9'7"	2705 mm 8'11"
Weight, Approximate	2085 kg 4600 lb	1555 kg 3430 lb	2130 kg 4700 lb	1540 kg 3400 lb

NOTE: Third valve required. Counterweight recommended.
 Logging forks with millyard style clamps are available where logging application requires clamp to close between tines.
 Contact your Caterpillar Dealer or Caterpillar Attachment Products and Services for more information.

USE OF LOG VOLUME TABLES

The tabulated volumes on these pages were calculated with no taper in log diameter from base to top. Therefore each value listed in the table represents the volume of a true cylinder. In practice this may occur only in short sections of large diameter trees. To obtain the volume of solid wood logs, excluding bark:

1. Establish the base diameter of the log inside the bark and above the butt flare (extreme end taper).
2. Repeat the procedure for the top (small end) of log.
3. Enter log volume table at each of the two established diameters. Move horizontally to the vertical column closest to the length of the log being measured.
4. Establish the volume figures for each end of the log, add the two together and divide by two to obtain average log volume.

METRIC LOG VOLUMES (in Cubic Meters)

Log Diameter (cm)	LOG LENGTH (METERS)														
	2	4	6	8	10	12	14	16	18	20	22	24	26	28	30
10	0.016	0.031	0.047	0.063	0.078	0.094	0.12	0.13	0.14	0.16	0.17	0.19	0.20	0.22	0.24
15	0.035	0.071	0.11	0.14	0.18	0.21	0.25	0.28	0.32	0.35	0.39	0.42	0.46	0.49	0.53
20	0.06	0.13	0.19	0.25	0.31	0.38	0.44	0.50	0.57	0.63	0.69	0.75	0.82	0.86	0.94
25	0.10	0.20	0.30	0.39	0.49	0.59	0.69	0.79	0.88	0.98	1.08	1.18	1.28	1.37	1.47
30	0.14	0.28	0.42	0.57	0.71	0.85	0.99	1.13	1.27	1.42	1.56	1.70	1.84	1.98	2.12
35	0.19	0.38	0.58	0.7	0.96	1.15	1.35	1.54	1.73	1.93	2.12	2.31	2.50	2.69	2.89
40	0.25	0.50	0.75	1.01	1.26	1.51	1.77	2.02	2.27	2.52	2.78	3.02	3.27	3.51	3.77
45	0.32	0.64	0.95	1.27	1.59	1.91	2.22	2.54	2.86	3.18	3.50	3.82	4.13	4.45	4.77
50	0.39	0.79	1.18	1.57	1.96	2.36	2.76	3.16	3.54	3.94	4.34	4.71	5.10	5.49	5.89
55	0.48	0.95	1.43	1.90	2.38	2.85	3.33	3.80	4.28	4.75	5.23	5.70	6.18	6.65	7.12
60	0.57	1.13	1.70	2.26	2.83	3.39	3.96	4.52	5.09	5.65	6.22	6.78	7.35	7.92	8.48
65	0.66	1.33	1.99	2.65	3.32	3.98	4.65	5.31	5.98	6.64	7.30	7.96	8.62	9.29	9.95
70	0.77	1.54	2.31	3.08	3.85	4.62	5.40	6.15	6.93	7.70	8.48	9.23	10.0	10.77	11.54
75	0.88	1.77	2.65	3.53	4.42	5.30	6.19	7.06	7.95	8.84	9.72	10.60	11.49	12.37	13.25
80	1.01	2.01	3.02	4.02	5.03	6.03	7.05	8.06	9.07	10.08	11.09	12.10	13.10	14.10	15.10
85	1.13	2.27	3.40	4.54	5.67	6.81	7.94	9.08	10.20	11.32	12.47	13.62	14.75	15.89	17.02
90	1.27	2.54	3.82	5.09	6.36	7.63	8.90	10.17	11.43	12.71	13.99	15.27	16.54	17.81	19.10
95	1.42	2.84	4.75	5.67	7.09	8.51	9.92	11.33	12.76	14.18	15.60	17.01	18.43	19.85	21.26
100	1.57	3.14	4.71	6.28	7.85	9.42	11.0	12.58	14.16	15.72	17.30	18.85	20.42	22.0	23.56
125	2.45	4.90	7.36	9.82	12.27	14.73	17.18	19.6	22.1	24.5	27.0	29.5	32.0	34.4	36.8
150	3.53	7.1	10.6	14.1	17.7	21.2	24.7	28.3	31.8	35.3	38.8	42.4	45.9	49.5	53.0
175	4.8	9.6	14.5	19.2	24.0	28.9	33.7	38.5	43.3	48.1	53.0	57.7	62.6	67.3	72.2
200	6.3	12.6	18.8	25.1	31.4	37.7	44.0	50.3	56.5	62.8	69.1	75.4	81.7	88.0	94.2

ENGLISH MEASURE LOG VOLUMES (in Cubic Feet)

Log Diameter (inches)	LOG LENGTH (FEET)																	
	8	12	16	20	24	28	32	36	40	44	48	52	56	60	70	80	90	100
4	0.7	1	1.4	1.7	2.1	2.4	2.8	3.1	3.5	3.8	4.2	4.5	4.9	5.2	6.1	7	7.8	8.7
6	1.6	2.4	3.1	3.9	4.7	5.5	6.3	7.1	7.8	8.6	9.4	10	11	12	13	16	18	20
8	2.8	4.2	5.6	7	8.4	9.8	11	13	14	15	17	18	19	21	24	28	31	35
10	4.4	6.5	8.7	11	13	15	17	20	22	24	26	28	31	33	38	44	49	55
12	6.3	9.4	13	16	19	22	25	28	31	35	38	41	44	47	55	63	71	79
14	8.5	13	17	21	26	30	34	39	43	47	51	56	60	64	74	86	96	101
16	11	17	22	28	34	39	45	50	56	61	67	73	78	84	98	112	126	140
18	14	21	28	35	42	49	57	64	71	78	85	92	99	106	124	141	159	177
20	17	26	35	44	52	61	70	79	87	96	105	113	122	131	153	175	196	218
22	21	32	42	53	63	74	85	95	106	116	127	137	148	158	185	211	238	264
24	25	38	50	63	75	88	101	113	126	138	151	163	176	189	220	251	283	314
26	29	44	59	74	89	103	118	133	147	162	177	192	207	221	258	295	332	369
28	34	51	68	86	103	120	137	154	171	188	205	222	240	256	299	342	385	428
30	39	59	79	98	118	137	157	177	196	216	236	255	275	295	344	393	442	491
32	45	67	89	118	134	156	179	201	223	246	268	290	313	335	391	447	503	559
34	50	76	101	126	151	177	202	227	252	277	303	328	353	378	441	504	567	631
36	57	85	113	141	170	198	226	255	282	311	339	368	396	424	495	566	637	707
38	63	95	126	158	189	220	252	284	315	347	378	410	441	473	551	630	709	788
40	70	105	140	175	210	244	279	314	349	384	419	454	489	524	611	698	785	873
50	109	164	218	273	327	382	436	491	545	600	645	709	764	818	955	1091	1227	1364
60	157	234	314	393	471	550	628	707	785	864	943	1021	1100	1178	1374	1571	1767	1964
70	214	321	428	535	642	748	855	962	1069	1176	1283	1389	1497	1604	1871	2138	2405	2673
80	279	420	559	698	838	977	1117	1257	1396	1536	1676	1815	1955	2095	2441	2293	3142	3491

WEIGHTS OF COMMERCIALY IMPORTANT WOODS

Species	kg/m ³ (Green)	lb/ft ³ (Green)
A. Temperate Zone*		
Alder, Red	737	46
Ash, White	769	48
Aspen	689	43
Baldcypress	817	51
Basswood	673	42
Beech	865	54
Birch, Paper	801	50
Yellow	929	58
Cedar, Alaska	577	36
Incense	721	45
Northern, White	449	28
Port-Orford	897	56
Western Red	433	27
Cherry, Black	721	45
Cottonwood, Eastern	785	49
Douglas Fir, (Coast)	881	55
(Inland Empire)	577	36
Elm, American	865	54
Fir, Alpine	449	28
Balsam	721	45
Nobel	481	30
Red	769	48
Silver	577	36
White	753	47
Gum, Black	721	45
Blue	1121	70
Red	801	50
Tupelo	897	56
Hemlock, Eastern	801	50
Western	961	60
Hickory, Pecan	993	62
True	1009	62
Larch, Western	769	48
Locust, Black	929	58
Magnolia, Cucumber	785	49

Species	kg/m ³ (Green)	lb/ft ³ (Green)
Maple, Big Leaf	753	47
Black	865	54
Red	801	50
Silver	721	45
Sugar	897	56
Oak, Black	1009	63
Chestnut	977	61
Red	1009	63
Red, Swamp	1073	67
Swamp Chestnut	1041	65
White	993	62
White, Swamp	1105	69
Pine, Jack	801	50
Loblolly	993	62
Lodgepole	625	39
Long Leaf	993	62
Norway (Red)	673	42
Short Leaf	993	62
Slash	993	62
Sugar	817	51
Western Yellow, (Ponderosa)	721	45
White (Western)	561	35
White (Eastern)	577	36
Poplar, Yellow	609	38
Redwood	801	50
Spruce, Black	513	32
Engleman	625	39
Red	545	34
Sitka	529	33
White	545	34
Sweetgum	801	50
Sycamore	833	52
Tamarack	753	47
Walnut, Black	929	58
Willow, Black	801	50

*NOTE: Weights taken from U.S. Dept. of Agriculture handbook No. 72, Wood Handbook.

Weights of Commercially Important Woods

● Southeast Asia

● West Africa

Logging and Forest Products

Species	kg/m ³ (Green)	lb/ft ³ (Green)
B. Southeast Asia		
Apitong	961	60
Bintangor	865	54
Chumprak	929	58
Ebony	1746	109
Geronggang	721	45
Jelutong	641	40
Kapur (Borneo Camphorwood)	1073	67
Keruing	1121	70
Krabak	817	51
Kruen	1121	70
Lumbayau	929	58
Mahogany, Philippine		
(Red Luan)	753	47
(White Luan)	769	48
(Yellow Luan)	769	48
Mahoni	913	57
Alayan Kauri (Damar Minyak)	817	51
Melantai	705	44
Melapi	849	53
Mangkulang	929	58
Meranti Bakau	849	53
Meranti, Dark Red	753	47
White	769	48
Yellow	769	48
Mersawa	817	51
Nyatoh	897	56
Palosapis	817	51
Pulai	545	34
Ramin	1073	67
Rosewood (Sonokelina)	1314	82
Seraya, Dark Red	753	47
Yellow	769	48
White	769	48
Teak	1073	67

Species	kg/m ³ (Green)	lb/ft ³ (Green)
C. West Africa		
Abura	850	53.06
Ako	800	49.94
Azobe	1300	81.16
Aniegre (Mukali)	950	59.31
Bete	900	56.19
Bosse	900	56.19
Bubinga	1000	62.43
Dibetau	750	46.82
Douka (Makore)	950	59.31
Doussie	1200	74.91
Framire	850	53.06
Fromager	550	34.34
Ilomba	750	46.82
Iroko	1200	74.91
Kokrodua (Afromosia)	1000	62.43
Kosipo	900	56.19
Limba	750	46.82
Mahogany	750	46.82
Moabi	1100	68.67
Niangon	900	56.19
Okoume	650	40.57
Ozigo	900	56.19
Padouk	1000	62.43
Samba (Obeche)	650	40.58
Sapelli	900	56.19
Sipo	800	49.94
Tchitola	850	53.06
Tiaba	900	56.19
Tola	850	53.06

Logging and Forest Products

Weights of Commercially Important Woods

- Australia
- New Zealand
- Papua New Guinea

Species	kg/m ³ (Green)	lb/ft ³ (Green)
D. Australia		
Ash Alpine	1041	65
Mountain	1009	63
Silvertop	1330	83
Black Butt	1121	70
Box Long Leaf	993	62
Yellow	1105	69
Black	1105	69
Brownbarrel	1073	67
Candle Bark	657	41
Gum Grey	1217	76
Manna	1121	70
Mountain	1169	73
Mountain Grey	1057	66
River Red	1137	71
Forest Red	1201	75
Southern Blue	1217	76
Spotted	1201	75
Sydney Blue	1153	72
Iron Bark Gray	1330	83
Narrowleaved	1330	83
Red	1330	83
Jarrah	1169	73
Karri	1169	73
Mahogany Red	1153	72
White	1282	80
Myrtle	1169	73
Peppermint	1120	70
Pine Radiata	865	54
Monerey	865	54
Celerytop	1057	66
Stringy Bark Brown	1233	77
Messmate	1169	73
Yellow	1217	76
White	1121	70
Tallowwood	1201	75
Wandoo	1282	80

Species	kg/m ³ (Green)	lb/ft ³ (Green)
E. New Zealand		
Exotic Softwoods		
Radiata Pine	1000	62
Douglas Fir	734	45
Corsican Pine	985	61
Redwood	1016	63
Larch	960	60
Indigenous Softwoods		
Mati	1120	70
Rimu	1130	70
Exotic Hardwoods		
Eucalyptus Botryoides	893	56
Eucalyptus Saligna	1200	75
Indigenous Hardwoods		
Beech — Silver	920	57
Beech — Red	1200	75
Tawa	1022	64

Species	kg/m ³ (Green)	lb/ft ³ (Green)
F. Papua New Guinea		
Pine, Hoop	520	32
Kauri	480	30
Klinki	510	31
Kwila	800	50
Erima	390	24
Taun	680	42
Walnut, PNG	560	35
Cedar, Pencil	720	50
Mersawa	650	40
Celtis, Hard	780	48
Rosewood, PNG	600	37
Beech, PNG	830	51
Oak, PNG	650	40
Ebony, PNG Black	1115	69
PNG White	720	50
Hardwood, Yellow	780	48
Hopea, Heavy	960	60
Light	710	44
Podocarp, Black	410	25
Terminalia, Brown	450	28

ESTIMATING NUMBER OF TREES PER HECTARE

Spacing (Meters)	Spacing (Meters)							
	1	2	3	4	5	6	7	8
1	10 000	5000	3333	2500	2000	1667	1428	1250
2	5000	2500	1667	1250	1000	834	714	625
3	3333	1667	1111	834	667	556	477	417
4	2500	1250	834	625	500	417	357	313
5	2000	1000	667	500	400	330	286	250
6	1667	834	556	417	333	278	238	208
7	1428	714	477	357	286	238	204	179
8	1250	625	417	313	250	208	179	156

ESTIMATING NUMBER OF TREES PER ACRE

Spacing (Feet)	Spacing (Feet)							
	5	6	7	8	9	10	11	12
5	1742	1452	1244	1089	968	871	792	726
6	1452	1210	1037	907	806	726	660	605
7	1244	1037	888	777	691	622	565	518
8	1089	907	777	680	605	544	495	453
9	968	806	691	605	537	484	440	403
10	871	726	622	544	484	435	396	363
11	792	660	565	495	440	396	360	330
12	726	605	518	453	403	363	330	302
13	671	558	478	418	372	335	304	279
14	622	518	444	390	346	311	283	259
15	580	484	415	363	323	290	264	242

COMPARISON OF LOG RULES • Board Foot Values for 16-Foot Logs

Diameter at Small End, Inside Bark, Inches	International 1/4 Inch	Scribner	Scribner Decimal	Spaulding	Doyle
4	5	10	10	—	—
6	20	18	20	—	4
8	40	32	30	—	16
10	65	54	60	50	36
12	95	79	80	77	64
14	135	114	110	114	100
16	180	159	160	161	144
18	230	213	210	216	196
20	290	280	280	276	256
22	355	334	330	341	324
24	425	404	400	412	400
26	500	500	500	488	484
28	585	582	580	569	576
30	675	657	660	656	676
32	770	736	740	748	784
34	875	800	800	845	900
36	980	923	920	950	1024
38	1095	1068	1070	1064	1156
40	1220	1204	1200	1185	1296

UNIT OF MEASUREMENT DEFINITIONS

1 board foot	= 1/12 ft ³ of solid wood (1' × 1' × 1")
1000 board feet	= 83.33 ft ³ of solid wood
1 c. unit of wood	= 100 solid ft ³ = 1200 board feet = 2.83 ³
1 cord of wood	= 128 ft ³ of stacked logs = 3.62 m ³
1 unit of wood	= 200 ft ³ of loose chips = 5.66 m ³
1 cord of wood	= 0.85 units
1 Hoppus Ton	= 50 ft ³ (assumed) = 63.65 ft ³ (actual) = 600 board feet = 763.8 BF Brereton = 1.8 m ³ actual = 1.4 m ³ assumed
1 cubic meter	= 35.32 ft ³ = 424 board feet = 333 board feet Hoppus tons = 0.555 Hoppus Tons
1 MBF Brereton	= 2.36 m ³ = 785.4 board feet Hoppus
1 MBF Hoppus MBF	= 1273 board feet-Brereton = Thousand board feet
1 Super Foot	= 1 board foot
100 Super Feet	= 1000 board foot = 0.236 m ³
600 Super Feet	= 50 ft ³
1 lb/ft ³	= 16.0185 kg/m ³

CUBIC FEET OF SOLID WOOD PER CORD

Length of Sticks-Ft.	Diameter at Small End		
	1"-2.5"	2.5"-5.5"	Over 5.5"
2	65	84	91
4	64	82	89
8	59	77	84
12	54	71	78

RULE OF THUMB CONVERSIONS

1 c. unit of wood = 1.117 cords = 1.25 units of chips = 250 ft ³ of chips = 7.08 m ³
1 cord of wood = 85 ft ³ of solid wood = 1.06 units of chips = 2.41 m ³
1 unit of chips = 80 ft ³ of solid wood = 2.27 m ³
1 cord of wood = 500 board feet = 1.18 m ³
2000 pounds of chips = 500 pounds of pulp
1 cord = 212 ft ³ of chips = 6 m ³

STOCKPILE COAL HANDLING

CONTENTS

Introduction	25-1
Machine selection	25-1
How to equip	25-2
Production factors	25-2
Estimating hourly production	25-3
Track-Type Tractors	25-4
Wheel Tractors	25-5
Wheel Loaders	25-7
Wheel Tractor-Scrapers	25-8
Example problem	25-9

INTRODUCTION

Efficient methods have been developed for handling and storing coal with mobile equipment. Generally, a power plant or other industrial facility which uses coal, meets its daily requirements with incoming coal shipments and will maintain an emergency stockpile or deadpile. The deadpile is designed to meet the burn requirements during any interruption of coal shipments. Interruptions may include inclement weather, carrier strikes, scheduling problems, etc.

The deadpile will contain approximately a 90 day supply of coal and is constructed by thoroughly compacting lifts, or layers, of coal approximately 15 cm (6 in) thick. Thorough compaction of the entire stockpile, including the sides, eliminates air spaces, reducing the possibility of spontaneous combustion.

Reclaiming the deadpiled coal is critical when incoming shipments are not able to satisfy the burn requirements. Four basic types of mobile equipment are available for stockpiling and reclaiming coal — track-type tractors, wheel tractors, wheel loaders, and wheel tractor-scrappers. Each type has its own specific advantages. The equipment selected must be able to meet the maximum hourly burn rate.

MACHINE SELECTION

Track-Type Tractors

Track-type tractors continue to be the most widely used machines for coal handling operations. Equipped with a U-shaped coal dozer, they are suitable for meeting high production requirements over dozing distances of less than 152 m (500 ft). Their

tractive capabilities and gradeability permit them to operate on the sides of the stockpile and surge pile which often prove inaccessible to other types of equipment. They can also remove snow and frost penetrated coal from the stockpile surface so that rubber-tired equipment can work efficiently.

Wheel Tractors

These machines, with their long wheel base, low center of gravity, and articulated design, offer good stability and maneuverability. They have the ability to travel at a higher speed than the track-type tractor, moving easily from one area of operation to another, and provide greater compactive effort with fewer passes. They are capable of performing some utility functions. However, their coefficient of traction is less than that of track-type tractors. The most efficient dozing distance for the wheel tractor is usually less than 152 m (500 ft).

Coal scoops are also available for wheel tractors and may improve production under certain operating conditions.

Wheel Loaders

As dozing and hauling distances increase, wheel loaders are able to effectively move coal in load-and-carry operations. Since coal is a relatively light material, the loaders should be equipped with larger buckets sized for coal density. Versatility and mobility allow them to perform a variety of tasks, both on and off the stockpile. They can load trucks or railcars, dig out bottom ash and boiler slag from the ash storage areas, and move railcars within the vicinity of the power plant. Generally wheel loaders are more efficient than track or wheel tractors at distances of 122 m (400 ft) or more.

Coal Scrapers

Tandem powered coal scrapers are generally used when large volumes and long haul distances [over 152 m (500 ft)] are involved. They are able to effectively self-load coal, and have the advantage of being able to provide both high speed and large capacity; in addition, scrapers provide the greatest compactive effort. Coal scrapers are even more effective when top loading systems and drive-over reclaiming hoppers are used.

HOW TO EQUIP

Counterweighting

While larger blades or buckets allow for greater production, counterweighting is often necessary to improve the machine's balance and handling capability. For track-type tractors, a rear counterweight is recommended. Wheel machines use various methods to add weight. For example, scoop dozers use front counterweights, and wheel machines often use tire ballast. Below is a weight comparison of the Caterpillar standard U-blade to the Balderson Coal Dozer, along with the recommended counterweight for D11R, D10R, D9R, D8R, and 834B.

**COAL STOCKPILE BLADE WEIGHT COMPARISON/
COUNTERWEIGHTING**

Model	Caterpillar U-Blade		Balderson Coal Dozer/ Scoop		Counterweight	
	kg	lb	kg	lb	kg	lb
D11R	11 608	25,590	10 115	22,300	4989	11,000
D10R	6188	13,643	6620	14,600	2928	6,456
D9R	4179	9,214	4490	9,900	3142	6,926
D8R	2825	6,228	3560	7,850	2749	6,060
834B	2994	6,600	4070	8,975	75% CaCl ₂ in all tires —	
*834B with Balderson Scoop			8700	19,180	5360	11,816

Both Caterpillar and Balderson weights include blade or scoop only. The change in machine weight is determined by adding or subtracting the difference between the Caterpillar and Balderson blade. Counterweight or ballast may also need to be considered.

Track Shoe Width

Track shoes are an important consideration since shoe width determines tractive capability and compaction. Depending on the coal being stockpiled, the utility company will often have a strong preference concerning track shoe width. Basically, utilities stockpiling low rank or sub-bituminous rank lignite coal usually prefer the standard shoe width for maximum compactive effort to reduce the possibility of spontaneous combustion.

Utilities burning medium or high rank bituminous coals are not as concerned with spontaneous combustion and sometimes prefer a wider shoe that allows increased tractive capability on loose or less densely compacted coal stockpiles.

Tires

Many utility companies have established a tire preference for wheel machines. Normally a radial tire allows for the maximum tire print in the stockpile surface providing the best traction.

Tire pressure may be of equal importance to tire selection. Tests with hydro-inflated (liquid ballasting) tires indicate that inflation pressure of approximately 275 kPa (40 psi) improves machine performance over higher inflation pressure. Lower than 275 kPa (40 psi) is not recommended for hydro-inflated tires. (For more hydro-inflation information see the Tire section.)

Other

The 834B's performance may be improved in the varying underfoot conditions of a coal stockpile with the use of a Detroit NoSPIN differential. This differential provides added tractive capability on all coal piles, particularly loose coal.

PRODUCTION FACTORS

1. *The effect of grade* — dozer production will increase 3% for each 1% of favorable grade and decrease 2% for each 1% of adverse grade up to grades of 10%. The graph below exemplifies this point.

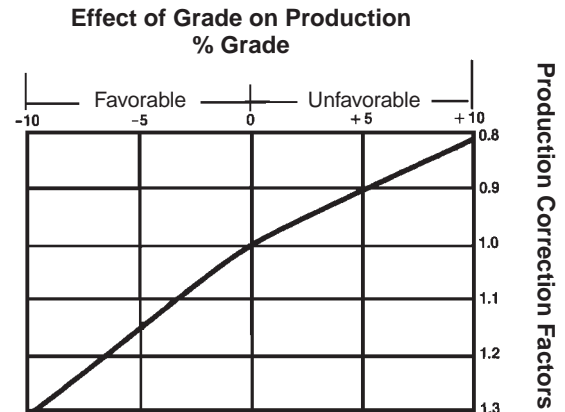

As a rule of thumb, track-type tractors can negotiate grades of about 60% in loose coal. Wheel tractor dozers can negotiate grades up to 25% on fairly well compacted coal.

2. *Slot dozing*, which consists of dozing repeatedly in the same tracks, will increase production. The deeper the slot, the greater the increase in production. Obviously this will disrupt the surface of the pile; however it does provide maximum production.

Slot Condition	Slot Depth	Increase in Production
Slight	60 cm ~ 2 ft	10%
Consistent	60 cm-1.5 m ~ 2-5 ft	25%
Very Consistent	Over 1.5 m ~ Over 5 ft	30% +

3. *Relative traction* — machines will provide greater-tractive effort as the compaction beneath them increases.

Condition:	Machine	Coefficient of Traction
Well Compacted Coal	Track-type	*0.75-0.80
	Wheel	0.40-0.50
Loose Coal	Track-type	*0.60
	Wheel	0.30-0.40

*D11R, D10R, D9R and D8R will often achieve a higher coefficient of traction due to their suspended undercarriage.

4. *Rolling Resistance* of rubber tired equipment will decrease as the compaction of the coal beneath the machines increases. Here are total rolling resistances on various surfaces.

	kg/Metric Ton	lb/U.S. Ton
● Main travel area from loading area to stockpile traveled and maintained.	29	65
● Travel over the compacted deadpile.	36	80
● Travel over thin lifts of uncompacted coal on the deadpile.	54	120
● Travel on loose piles under stacking conveyor or on a windrow.	90-136	200-300

5. *The degree of compaction required* — for medium and high rank bituminous coal, track-type tractors will normally provide ample compaction to prevent fires. For low rank coals, such as sub-bituminous and lignite, rubber tired machines, pneumatic compactors or sealing may be required to prevent fires. The following table illustrates the compaction that is possible if the coal is spread in thin lifts and the machine makes a sufficient number of passes over the entire lift surface.

Machine	kg/m ³	lb/ft ³	lb/yd ³
Track-type Tractors	960-1160	60-72	1620-1950
Wheel Tractors	1040-1200	65-75	1750-2030
Wheel Loaders	1040-1250	65-78	1750-2110
Wheel Tractor-Scrapers	1100-1280	68-80	1840-2160

ESTIMATING HOURLY PRODUCTION

The following graphs may be used for estimating the hourly production of machines handling mixed bituminous coal. The graphs are based on 100% machine efficiency under normal job conditions and average operator; they do not take into account adverse grades, downtime, wait time, poor traction, etc. These production estimates should be evaluated in light of individual job conditions and efficiency. Moreover, a job efficiency correction factor should be applied to the production estimate shown when using these graphs.

To estimate travel times for a specific machine refer to the performance graphs or charts in the appropriate model section of this book.

NOTE: Capacities and production curves on the next pages are based on bituminous coal with a density of 890 kg/m³ or 1500 lb/yd³ or 55 lb/ft³. For sub-bituminous coal with a density of 800 kg/m³ or 1350 lb/yd³ or 50 lb/ft³ multiply tonnage figure by .90. For lignite with an average density of 710 kg/m³ or 1200 lb/yd³ or 45 lb/ft³ multiply tonnage figure by .80.

Track-Type Tractors Estimated Production with Balderson U-Blade (Coal Dozer)

Factors:

- Mixed Bituminous Coal
- Storage and Reclamation
- 0% Grade
- .80 Coefficient of Traction

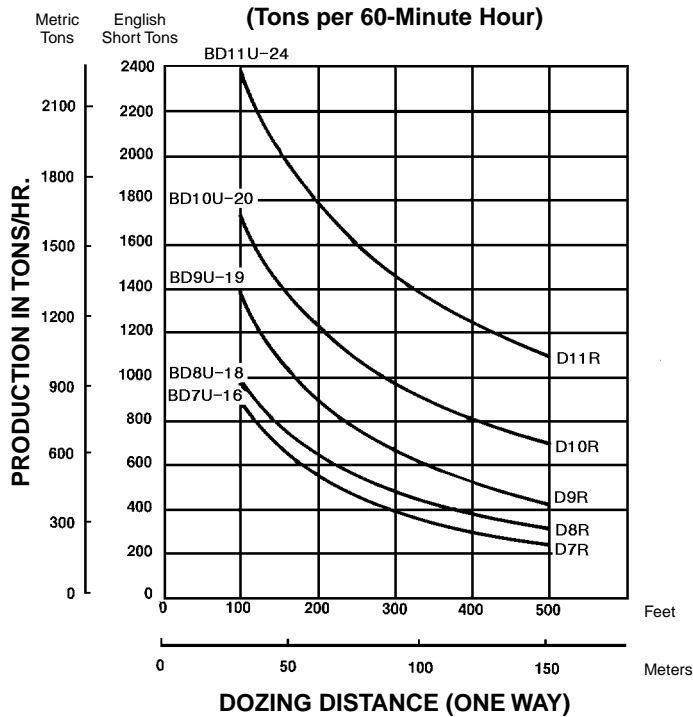

NOTE: This chart is based on numerous field studies made under varying job conditions. Refer to correction factors following these charts.

Tractor	Balderson U-Blade			Blade Capacities			
	Model	m	ft	Metric tons	U.S. tons	m ³	yd ³
D11R	BD11U-24	7.32	24'	64.0	70.5	71.9	94
D10R	BD10U-20	6.10	20'	40.85	45.0	45.9	60
D9R	BD9U-19	5.79	18'	31.8	35.1	35.6	46.8
D8R	BD8U-18	5.49	18'	19.0	21.0	21.4	28
D7R	BD7U-16	4.88	16'	14.28	15.75	16.05	21
D6R	BD6U	4.27	14'	8.84	9.75	9.9	13

Refer to Track-Type Tractor/Bulldozer section for additional special attachment specifications.

Wheel Tractors Estimated Production with Balderson U-Blade (Coal Dozer)

NOTE: This chart is based on numerous field studies made under varying job conditions. Refer to correction factors following these charts.

Factors:

- Mixed Bituminous Coal
- Storage and Reclamation
- 0% Grade
- .80 Coefficient of Traction

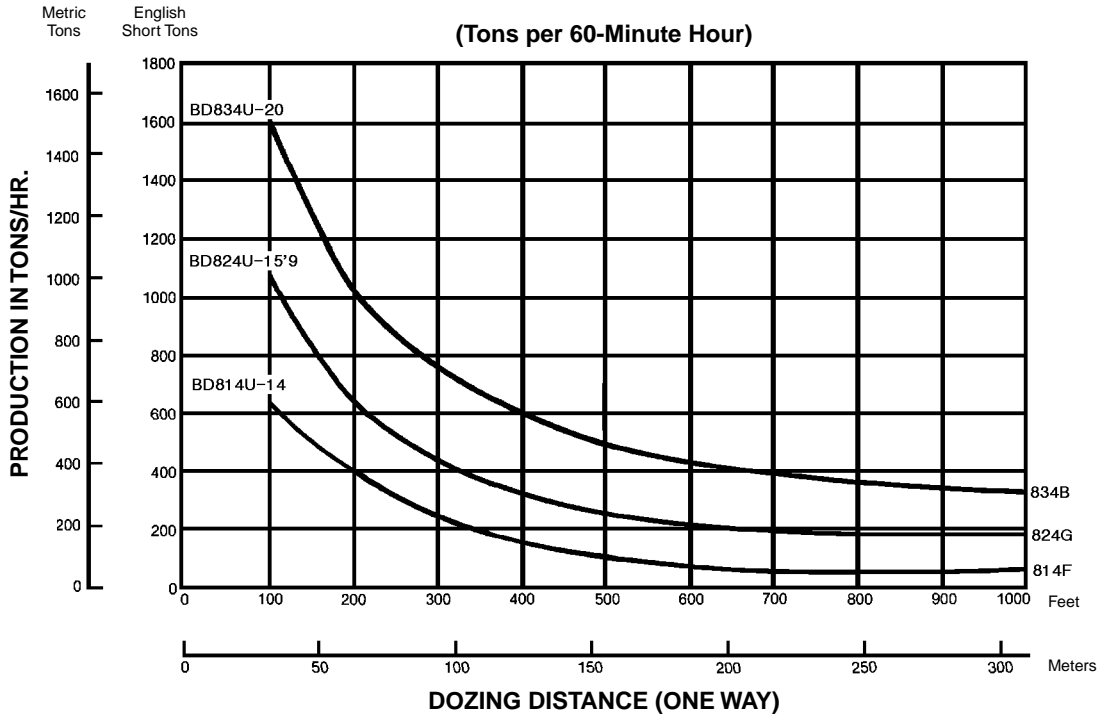

25

Tractor	Balderson U-Blade			Blade Capacities			
	Model	m	ft	Metric tons	U.S. tons	m ³	yd ³
834B	BD834U-20	6.17	20'3"	18.8	20.8	21.2	27.7
824G	BD824U-15'9	4.79	15'9"	14.3	15.8	16.1	21.10
814F	BD814U-14	4.32	14'2"	9.4	10.3	10.6	13.8

NOTE: Blade capacities in tons figured using weight of coal at 890 kg/m³ (1500 lb/yd³).

Refer to Track-Type Tractor/Bulldozer section for additional special attachment specifications.

**Wheel Tractors Estimated Production
 with Balderson Coal Scoop**

- Factors:**
- Mixed Bituminous Coal
 - Storage and Reclamation
 - 0% Grade
 - .80 Coefficient of Traction

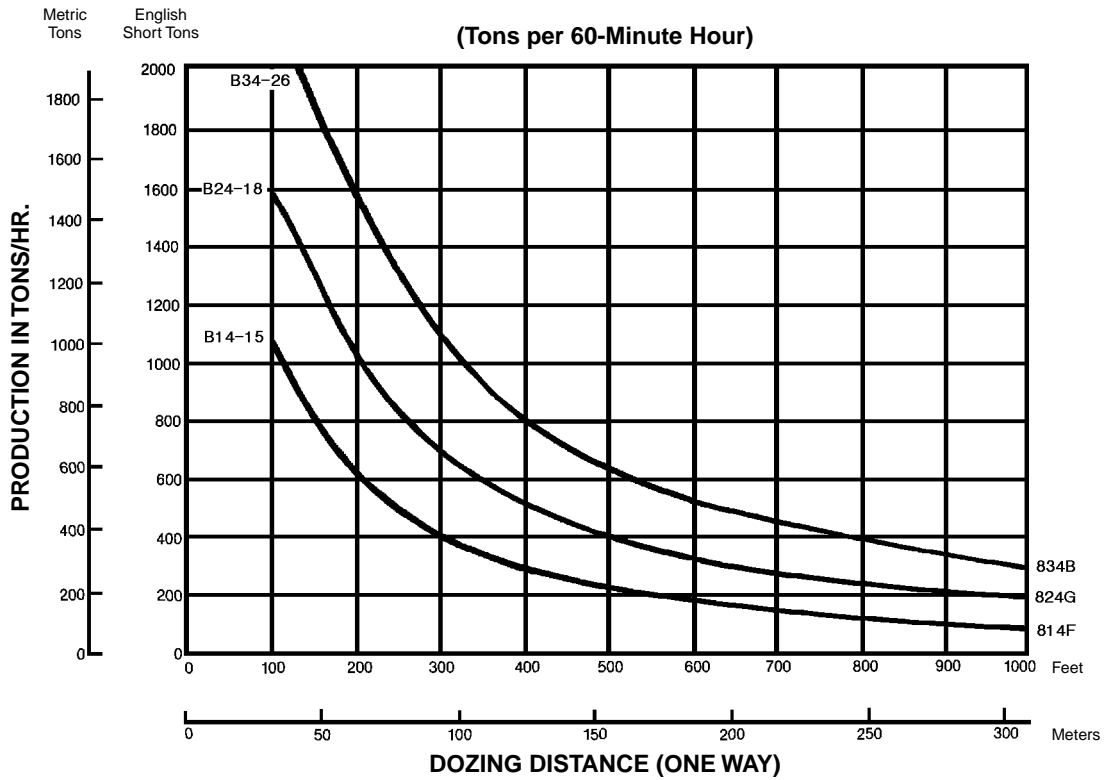

Tractor	Balderson Coal Scoop			Scoop Capacities (Lift and Carry)				Doze Capacities			
	Model	m	ft	Metric tons	U.S. tons	m ³	yd ³	Metric tons	U.S. tons	m ³	yd ³
834B	B34-26	5.3	17'4"	18.3	20.2	19.9	26	37.5	41.25	37.5	49
824G	B24-17	4.0	13'2"	12.3	13.5	13.0	17	24.5	27.0	26.0	34
814F	B14-15	3.7	12'3"	8.2	9.0	11.5	15	16.3	18.0	19.1	25

Refer to Track-Type Tractor/Bulldozer section for additional special attachment specifications.

Wheel Loaders Estimated Production
with Balderson Coal Bucket

Factors:

- Mixed Bituminous Coal
- Storage and Reclamation
- 0% Grade
- .80 Coefficient of Traction

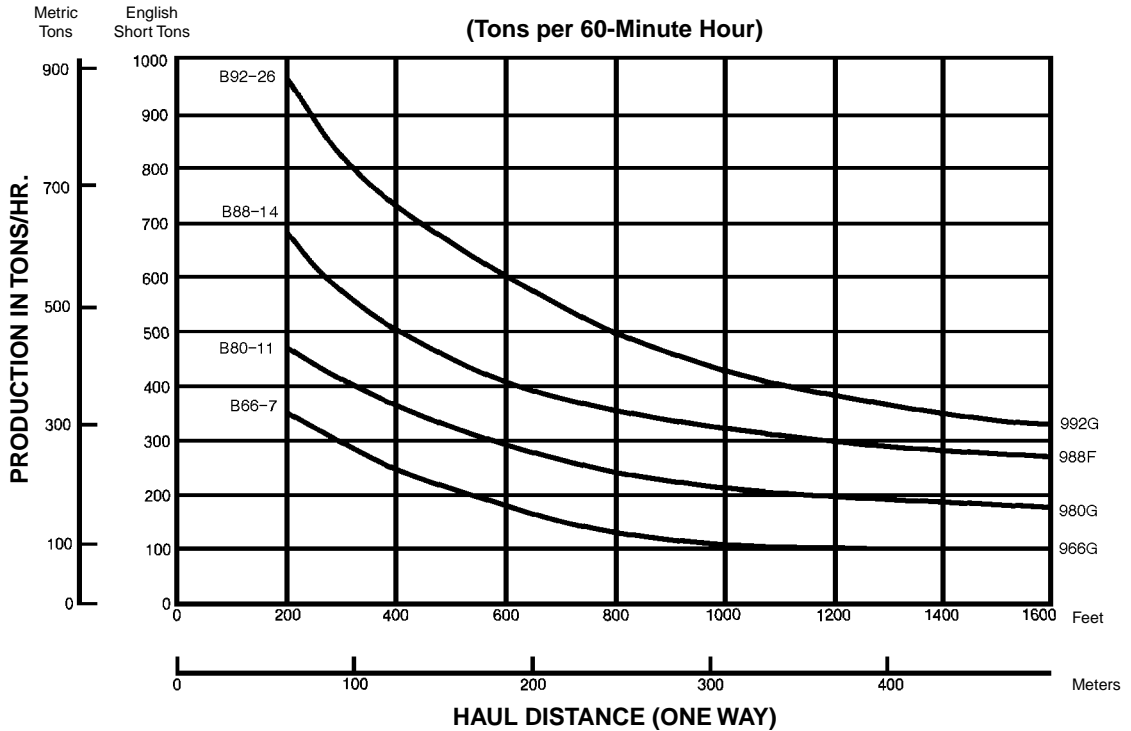

25

Loader	Balderson Coal Bucket	Blade Capacities			
	Model	Metric tons	U.S. tons	m ³	yd ³
992G	B92-25	17.0	18.8	19.3	25.25
988F	B88-14	9.4	10.4	10.3	13.5
980G	B80-11	7.3	8.1	8.2	10.75
966G	B66-7	4.8	5.3	5.5	7.25

NOTE: Bucket capacities include bottom cutting edge in tons figured using weight of coal at 890 kg/m³ (1500 lb/yd³).

Wheel Tractor-Scrapers Estimated Production

Factors:

- Mixed Bituminous Coal
- Storage and Reclamation
- 0% Grade
- .50 Coefficient of Traction

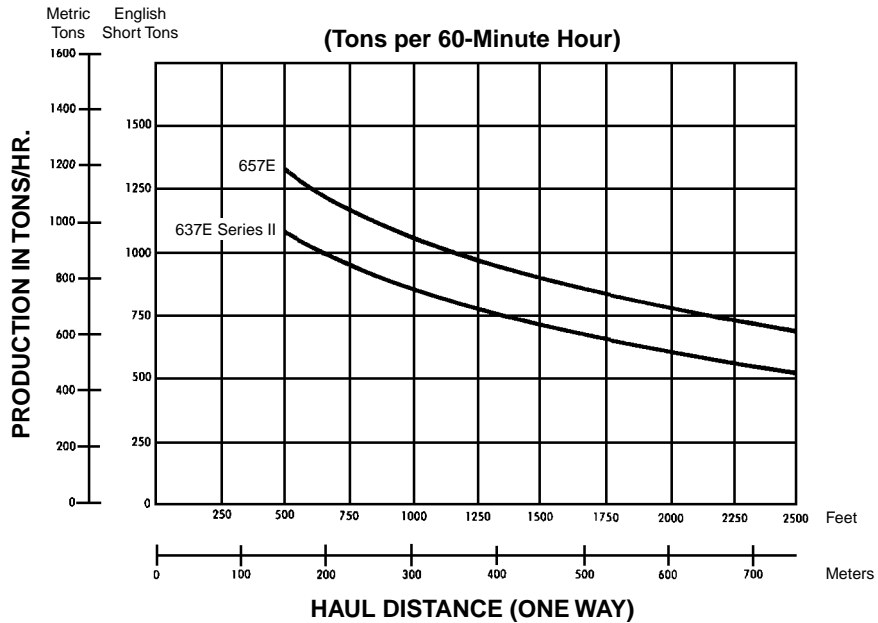

Coal Scraper	Bowl Capacities									
	Metric tons	U.S. tons	Struck		1:1		2:1		3:1	
			m ³	yd ³	m ³	yd ³	m ³	yd ³	m ³	yd ³
657E	49.9	55	45	59	56	73	50	65	47	62
637E Series II	34.5	38	31	41	38	50	34	45	37	44

Average fixed time to load, maneuver and dump:
 657E — 1.12 min.
 637E Series II — 1.10 min.

NOTE:

- The 657E Coal Scraper is 1049 mm (41.3") longer and bowl sides and apron are 1080 mm (42.5") higher than its earthmoving counterpart.
- The 637E Series II Coal Scraper is 762 mm (30") longer and bowl sides, apron and ejector are 915 mm (36") higher than its earthmoving counterpart.
- The rimpull, travel times, and retarder performance for the coal scrapers are the same as for the standard machines. See Wheel Tractor-Scrapers section for charts and graphs.

Example Problem

A coal-fired utility company has a coal requirement of approximately 315 metric tons (350 tons) per hour. Specify the coal handling machine that will satisfy this demand.

Conditions:

- Lignite Coal 710 kg/m³ (1200 lb/yd³)
- 90 m (300 ft) push distance
- 5% adverse grade
- 50 minute hour operation efficiency

Solution:

Calculate the D9R's production equipped with the Balderson BD9U-19 Coal U-Blade by using the D9R production curve. Start at 90 m (300 ft) and read up to the D9R production line, then over to the left to determine its maximum hourly production of 612 metric tons (675 tons).

Since the graphs are based on a 890 kg/m³ (1500 lb/yd³) coal density, this production figure has to be adjusted to reflect lignite coal:

Coal density correction factor = $710/890$ (1200/1500) = 0.8.

Obtain the production correction factor for the 5% adverse grade from the chart: 0.9.

The correction factor for the 50 minute hour is $50/60 = .83$.

Now calculate the adjusted D9R hourly production using the correction factors:

$$\begin{aligned} \text{Metric} & 612 \times .8 \times .9 \times .83 = 366 \text{ tons/hour} \\ \text{English} & 675 \times .8 \times .9 \times .83 = 403 \text{ tons/hour} \end{aligned}$$

The D9R falls in the required production range. For short periods of peak power capacity, production could be increased by slot dozing.

Production for the D10R, 824G and 834B can be calculated using the same method.

D10R

$$\begin{aligned} \text{Metric} & 850 \times .8 \times .9 \times .83 = 508 \text{ tons/hour} \\ \text{English} & 935 \times .8 \times .9 \times .83 = 559 \text{ tons/hour} \end{aligned}$$

824G

$$\begin{aligned} \text{Metric} & 400 \times .8 \times .9 \times .83 = 239 \text{ tons/hour} \\ \text{English} & 440 \times .8 \times .9 \times .83 = 263 \text{ tons/hour} \end{aligned}$$

834B

$$\begin{aligned} \text{Metric} & 689 \times .8 \times .9 \times .83 = 412 \text{ tons/hour} \\ \text{English} & 760 \times .8 \times .9 \times .83 = 454 \text{ tons/hour} \end{aligned}$$

Therefore, the D9R or 834B could most economically satisfy the production requirements.

LAND CLEARING

CONTENTS

Variables affecting clearing operations	26-1
Job surveys	26-2
Clearing methods and equipment	26-2
Equipment selection table	26-3
Production estimating:	
General	26-4
Cutting	26-5
Piling	26-6
Special attachments	26-8

Land clearing must be treated more as an art than a science because production rates and methods vary greatly from one area to another. This section deals with the many variables in clearing and includes methods, equipment and procedures to determine productivity rates.

VARIABLES AFFECTING CLEARING OPERATIONS

Vegetative Growth — Factors affecting production and therefore cost, include the number of trees, size of trees, wood density, root systems, vines and undergrowth. These factors can be estimated by a “tree-count” as discussed under “Job Survey.”

End Use of Land — Since different end uses require different degrees of clearing (i.e. highways, dams, tree crops, row crops, etc.), this is one of the most important factors to consider in choosing the proper clearing method and equipment.

Soil Conditions or Bearing Capacity — Factors affecting clearing operations include topsoil depth, soil type, moisture content, and the presence of rocks and stones.

Topography — Grade and terrain factors such as steep slopes, ditches, swampy areas, boulders and even ant hills greatly affect the normal operation of some equipment.

Rainfall and Climate — Usually all phases of land clearing from cutting to burning are concerned to some degree with temperature changes and the amount of rainfall during the clearing operation.

Job Specifications — Specifications dictate the degree of clearing to be done, area size, completion dates, method of debris disposal, soil conservation and other factors which affect method and equipment selection.

JOB SURVEYS

Knowledge of rainfall and climate, end use of the land, and job specifications can be obtained from records, surveys, engineering studies, and written specifications. You should personally review the land to be cleared to gain other necessary and valuable information.

The survey should include a study of general topography and soil conditions. Note such problem factors as hills, rocks, or swamps which would significantly affect production or which would require special treatment.

Cruise the area to be cleared and determine the acreage of each vegetative type (i.e. upland woods, low timberlands, swamps). Make at least three tree counts at random for each vegetation type. To conduct these counts, randomly locate two points 100 meters (328 feet) apart. Count and measure vegetative growth along a straight line between these points for a width of about 5 meters (16 feet) on both sides. This gives the population of 1/10 hectare (1/4 acre).

NOTE:

1. Density of vegetation less than 30 cm (12 in) diameter
 - Dense — 1480 trees/hectare or more (600 trees/acre)
 - Medium — 990-1480 trees/hectare (400-600 trees/acre)
 - Light — less than 990 trees/hectare (400 trees/acre)
2. Presence of hardwoods expressed in percent
3. Presence of heavy vines
4. Average number of trees per hectare (2.47 acres) in each of the following ground level diameter size ranges:
 - Less than 30 cm (1 ft)
 - 31 cm-60 cm (1-2 ft)
 - 61 cm-90 cm (2-3 ft)
 - 91 cm-120 cm (3-4 ft)
 - 121 cm-180 cm (4-6 ft)
5. Sum of diameter of all trees per hectare (2.47 acres) above 180 cm (6 ft) in diameter at ground level.

CLEARING METHODS AND EQUIPMENT

Methods for Initial Felling — There are several methods indicating the degree of clearing for initial felling and several types of equipment for use with each method. Equipment use in different size vegetation and different size areas is summarized in the table on the next page. This information should serve only as a rough guideline in selecting equipment. The economical land area for each type of equipment will vary with the capital cost of equipment and moving cost. It is also affected by whether there are alternate uses for equipment such as using tractors for other construction work or tillage.

Land Clearing Machines — Job size, severity of job such as tree size, and time limit to complete will influence machine selection. Some machines, such as the D6R, D7R and D8R are more suited for this type work than others, but imagination and resourcefulness can allow the use of other types of machines in specific applications. For example, loaders are used more today in raking and piling operations than ever before.

Operator Protection and Machine Guarding — Daily production has been estimated to increase 20% when cab guards are used. Cabs designed specifically for clearing are available from Rome and other auxiliary equipment manufacturers.

The radiator, engine, and underside of the tractor must be well protected. Perforated hoods, screens, crankcase guards and hydraulic cylinder guards are generally recommended.

Generally speaking, lower cost clearing can be done with larger tractors if the amount of clearing involved is sufficient to merit the initial investment in the bigger machine. Because most clearing work requires frequent direction changes, a power shift transmission should be standard equipment. The direct drive transmission tractor is recommended when the tractor is used principally in constant drawbar work such as chaining or pulling a disc harrow. In most applications, a winch should also be considered on one of every three tractors in a fleet.

EQUIPMENT SELECTION TABLE

	UPROOTING	CUTTING AT OR ABOVE GROUND LEVEL	KNOCKING TO THE GROUND	INCORPORATING INTO THE SOIL
LIGHT CLEARING — Vegetation up to 5 cm (2 in) diameter				
Small areas 4.0 hectares (10 acres)	Bulldozer blade, axes, grub hoes and mattocks	Axes, machetes, brush hooks, grub hoes and mattocks, wheel-mounted circular saws	Bulldozer blade	Moldboard plows, disc plows, disc harrows
Medium areas 40 hectares (100 acres)	Bulldozer blade	Heavy duty sickle mowers [up to 3.7 cm (1½ in) diameter] tractor-mounted circular saws, suspended rotary mowers	Bulldozer blade, rotary mowers; flail-type rotary cutters; rolling brush cutters	Moldboard plows; disc plows, disc harrows
Large areas 400 hectares (1,000 acres)	Bulldozer blade, root rake, grubber, root plow, anchor chain drawn between two crawler tractors; rails	—	Rolling brush cutter; flail-type cutter; anchor chain drawn between two crawler tractors; rails	Undercutter with disc; moldboard plows; disc plows; disc harrows
INTERMEDIATE CLEARING — Vegetation 5 to 20 cm (2 to 8 in) diameter				
Small areas 4.0 hectares (10 acres)	Bulldozer blade	Axes, crosscut saws, power chain saws, wheel-mounted circular saws	Bulldozer blade	Heavy-duty disc plow; disc harrow
Medium areas 40 hectares (100 acres)	Bulldozer blade	Power chain saws, tractor-mounted circular saws, single scissor type tree shears	Bulldozer blade, rolling brush cutter [up to 12 cm (5 in) diameter], rotary mower [up to 10 cm (4 in) diameter]	Heavy-duty disc plow; disc harrow
Large areas 400 hectares (1,000 acres)	Shearing blade, angling (tilted) bulldozer blade, rakes, anchor chain drawn between two crawler tractors, root plow	Shearing blade (angling or V-type)	Bulldozer blade, flail-type rotary cutter, anchor chain	Bulldozer blade with duty harrow
LARGE CLEARING — Vegetation 20 cm (8 in) diameter or larger				
Small areas 4.0 hectares (10 acres)	Bulldozer blade	Axes, crosscut saws, power chain saws	Bulldozer blade	—
Medium areas 40 hectares (100 acres)	Shearing blade, angling (tilted), knockdown beam, rakes, tree stumper	Shearing blade (angling or V-type), tree shear [up to 70 cm (26 in) softwood; 35 cm (14 in) hardwood], shearing blade — power saw combination	Bulldozer blade	—
Large areas 400 hectares (1,000 acres)	Shearing blade, angling (tilted), tree pusher, rakes, tree stumper, anchor chain with ball drawn between two crawler tractors	Shearing blade (angling or V-type), shearing blade — power saw combination	Anchor chain with ball drawn between two crawler tractors. [Use dozer blade for trees over 18 cm (7 in).]	—

NOTE: The most economical size area for each type of equipment will vary with the relative cost of capital equipment versus labor. It is also affected by whether there are alternate uses for equipment such as using tractors for tillage.

PRODUCTION ESTIMATING

GENERAL — CONSTANT SPEED OPERATIONS

Production is the hourly clearing rate usually expressed in hectares or acres.

For many land clearing operations, production is calculated by multiplying the tractor speed by the width of cut and converting to hectares or acres per hour.

Metric system:

The base formula is:

$$\frac{\text{Width of cut (meters)} \times \text{speed (km/h)}}{10} = \text{hectares/h}$$

When an efficiency of 82.5% is used, the formula becomes:

$$\frac{\text{Width of cut (m)} \times \text{speed (km/h)} \times .825}{10} = \text{hectares/h}$$

English measure:

$$\frac{\text{Width of cut (ft)} \times \text{speed (mph)}}{43,560 \text{ (ft}^2\text{)}} = \text{acres/hr}$$

The American Society of Agricultural Engineers formula for estimating hourly production of a constant speed operation is based on 82.5% efficiency. With this efficiency, the formula becomes:

$$\frac{\text{Width of cut (ft)} \times \text{speed (mph)} \times .825}{43,560 \text{ (ft}^2\text{)}} = \text{acres/hr}$$

Width of cut is the effective working width of the equipment and may not be the same as its rated width. Working width should be measured on the job but can be estimated when necessary.

The actual machine speed can be determined by measuring the amount of time to travel a given distance. When using the metric system, the time to travel 16.7 meters or a multiple thereof, can be converted into kilometers per hour.

$$\frac{1.0}{\text{(Time in min. to travel 16.7 meters)}} = \text{speed (km/h)}$$

Since 88 ft/min. equals one mph, the lapsed time to travel 88 ft, or a multiple of 88 ft, can easily be converted into miles per hour.

$$\frac{1.0}{\text{(Time in min. to travel 88 ft)}} = \text{speed (mph)}$$

The following nomographs in both the Metric and English systems convert speed and width of cut directly into acres or hectares per hour at 82.5% efficiency without the need for calculations.

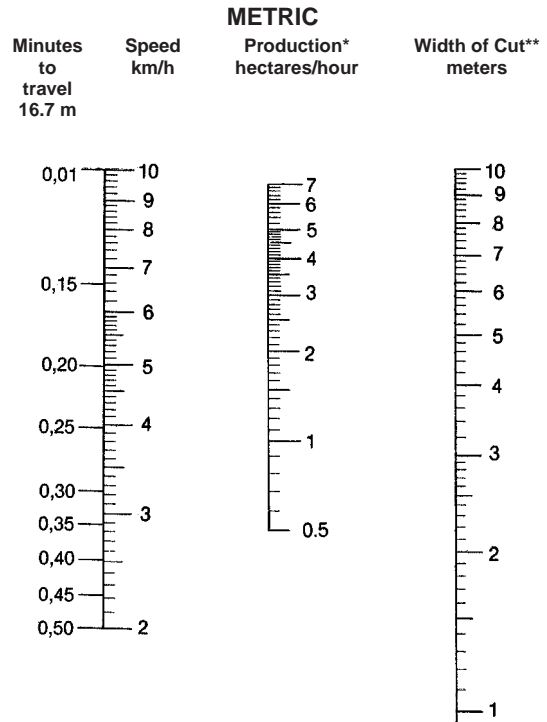

*Based on 82.5% efficiency.

**When width of cut exceeds 10 meters, use a multiple of the width of cut and increase production proportionately.

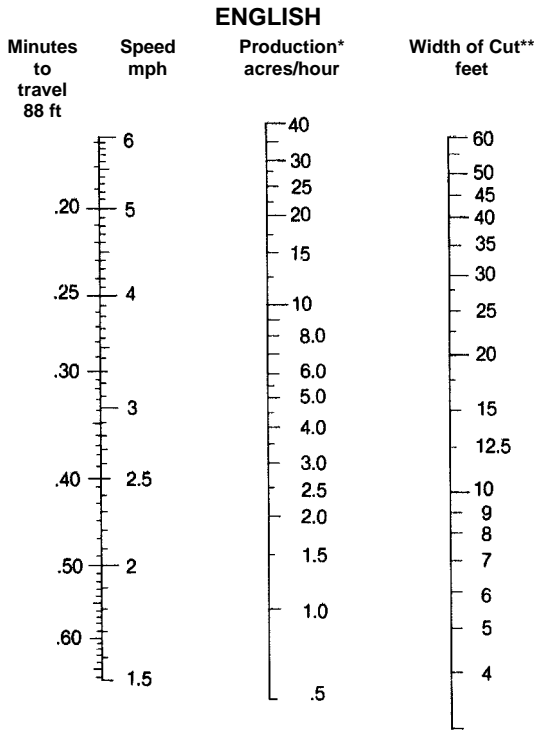

*Based on 82.5% efficiency.

**When width of cut exceeds 60 feet, use a multiple of the width of cut and increase production proportionately.

CUTTING PRODUCTION ESTIMATING

Most land clearing operations such as bulldozing, cutting, grubbing, raking and piling are not performed at constant speed. Because off-the-job production is difficult to estimate for these operations, Rome Industries has developed formulas for estimating cutting and piling time. These formulas take into consideration variable prime mover speeds through a factor, "B", the base time for each tractor to cover one hectare (2.47 acres) of light material.

To estimate **tractor cutting time per hectare** (2.47 acres) on a specific land clearing job, apply the factors shown in the following table, together with data obtained from the job survey, in the formula:

$$T = X [A(B) + M_1 N_1 + M_2 N_2 + M_3 N_3 + M_4 N_4 + DF]$$

where

T = Time per hectare (2.47 acres) in minutes

X = Hardwood or density factor affecting total time

A = Density or vine presence factor affecting base time

B = Base time for each tractor per hectare (2.47 acres)

M = Minutes per tree in each diameter range

N = Number of trees per hectare (2.47 acres) in each diameter range obtained from field survey

D = Sum of diameter in 30 cm (1 ft) increments of all trees per hectare (2.47 acres) above 180 cm (6 ft) in diameter at ground level obtained from field survey

F = Minutes per 30 cm (1 ft) of diameter for trees above 180 cm (6 ft) in diameter.

Hardwoods affect over-all or total time as follows:

75-100% hardwoods: Add 30% to total time (X=1.3)

25-75% hardwoods: No change (X=1.0)

0-25% hardwoods: Subtract 30% from total time (X=0.7)

Production Factors for Felling with Rome K/G Blades

Tractor	Base Minutes per hectare (2.47 acres) "B"	Diameter Range				Dia. above 180 cm per 30 cm (6' per foot) "F"
		30-60 cm (1-2 ft) "M ₁ "	60-90 cm (2-3 ft) "M ₂ "	90-120 cm (3-4 ft) "M ₃ "	120-180 cm (4-6 ft) "M ₄ "	
165 hp	85	0.7	3.4	6.8	—	—
230 hp	58	0.5	1.7	3.3	10.2	3.3
305 hp	45	0.2	1.3	2.2	6	1.8
405 hp	39	0.1	0.4	1.3	3	1.0

Explanation of columns in table:

Tractor — Based on current model tractors (power shift when applicable) working on reasonably level terrain (below 10% grade) with good footing, no stones, average mixture of soft and hard woods. Tractor is in proper operating condition, blade is sharp, and properly adjusted.

Base Minutes — The base figures represent the number of minutes required for each tractor to cover a hectare (2.47 acres) of light material where no trees require splitting or other individual treatment. Time required is affected by the density of material less than 30 cm (1 ft) in diameter and the presence of vines.

- dense — 1480 trees/hectare (600 or more trees/acre): Add 100% to base time (A=2.0)
- medium — 990-1480 trees/hectare (400-600 trees/acre): No change (A=1.0)
- light — less than 990 trees/hectare (400 trees/acre): Subtract 30% from total time (A=0.7)

- Cutting
- Piling

Presence of heavy vines: Add 100% to base time (A=2.0). Very heavy vines add 300% to base time. (A=3.0)

Dia. Range — M_1 represents minutes required to cut trees from 31-60 cm (1-2 ft) in diameter at ground level.

- M_2 same for trees 61-90 cm (2-3 ft) diameter.
- M_3 same for trees 91-120 cm (3-4 ft) diameter.
- M_4 same for trees 121-180 cm (4-6 ft) diameter.

For Dia. above 180 cm (6 ft) — The figures in this column represent size the number of minutes required per 30 cm (1 ft) of diameter for each tractor to cut trees above 180 cm (6 ft) in diameter. Thus, to fell a 240 cm (8 ft) diameter tree would require 8×1.8 or approximately 14.4 minutes with a D8R.

Example problem:

Calculate the felling production of a D8L with K/G Blade in these conditions: reasonably level terrain, firm ground, well drained, 85% hardwoods with heavy vines and the following average tree count per hectare (2.47 acre):

Diameter Range	Less than 30 cm (1 ft) "B"	31-60 cm (1-2 ft) "N ₁ "	61-90 cm (2-3 ft) "N ₂ "	91-120 cm (3-4 ft) "N ₃ "	121-180 cm (4-6 ft) "N ₄ "	Sum Dia's Above 180 cm (6 ft) "D"
Number of Trees	1100	35	6	6	4	488 cm (16 ft)

Solution:

$$\begin{aligned}
 T &= X [A(B)+M_1N_1+M_2N_2+M_3N_3+M_4N_4+DF] \\
 T &= 1.3 [2.0 (45)+0.2 (35)+1.3 (6)+2.2 (6)+6(4)+16 (1.8)] \\
 &= 1.3 (90+7+7.8+13.2+24+28.8) \\
 &= 1.3 (170.8) \\
 &= 222 \text{ minutes/hectare (90 min/acre)}
 \end{aligned}$$



Where the job requires grubbing trees and stumps greater than 30 cm (1 ft) in diameter at the same time the trees are sheared, use the same basic procedure as defined above including the variables for the presence of hardwoods. After time per hectare (acre) in minutes has been determined, increase the over-all or total time by 25%.

Where the job requires re-entering the area (after all trees have been sheared) to remove stumps with a tilted shearing blade or stump, increase the total time by 50%.

PILING PRODUCTION ESTIMATING

A procedure has also been developed for estimating piling production for a tractor equipped with a K/G blade or rake.

To estimate tractor hours per hectare (acre) on a specific land clearing job, apply the factors shown in the following table with data obtained from the job survey, in the formula:

$$T = B+M_1N_1+M_2N_2+M_3N_3+M_4N_4+DF$$

where

- T = Time per hectare (2.47 acre) in minutes.
- B = Base time for each tractor per hectare (2.47 acre).
- M = Minutes per tree in each diameter range.
- N = Number of trees per hectare (2.47 acre) in each diameter range obtained from field cruise.
- D = Sum of diameter in 30 cm (1 ft) increments of all trees per hectare (2.47 acre) above 180 cm (6 ft) in diameter at ground level obtained from field cruise.
- F = Minutes per 30 cm (1 ft) of diameter for trees above 180 cm (6 ft) in diameter.

Production Factors for Piling in Windrows*

Tractor	Base Minutes per hectare (2.47 acres) "B"	Diameter Range				Dia. above 180 cm per 30 cm (6' per foot) "F"
		30-60 cm (1-2 ft) "M ₁ "	60-90 cm (2-3 ft) "M ₂ "	90-120 cm (3-4 ft) "M ₃ "	120-180 cm (4-6 ft) "M ₄ "	
165 hp	157	0.5	1.0	4.2	—	—
230 hp	125	0.4	0.7	2.5	5.0	—
305 hp	111	0.1	0.5	1.8	3.6	0.9
405 hp	97	0.08	0.1	1.2	2.1	0.3

*May be used with most types of raking tools and angled shearing blade. Windrows to be spaced approximately 61 meters (200 feet) apart.

Explanation of columns in table:

Tractor — Production with tractor working alone based on current model tractors (power shift when applicable) working on reasonably level (below 10% grade) terrain with good footing, no stones, average mixture of soft and hard woods. The tractor is in proper operating condition. Decrease total time by 25-50% depending on the number and size of trees when using three or more tractors in combination.

Base Minutes — The base figures represent the number of minutes required for each tractor to cover a hectare (2.47 acres) of light material.

Dia. Range — M_1 represents minutes required to pile trees from 31-60 cm (1-2 ft) diameter at ground level.

M_2 same for trees 61-90 cm (2-3 ft) diameter.

M_3 same for trees 91-120 cm (3-4 ft) diameter.

M_4 same for trees 121-180 cm (4-6 ft) diameter.

For Dia. above 180 cm (6 ft) — The figures in this column represent for each tractor size the number of minutes required per 30 cm (1 ft) of diameter to pile trees above 180 cm (6 ft) in diameter. Thus, to pile a 240 cm (8 ft) diameter tree would require 8×0.9 or approximately 7.2 minutes with a D8L tractor.

Where the job requires piling of grubbed trees and stumps greater than 30 cm (1 ft) in diameter, use the same basic procedure defined above and then increase over-all or total time by 25%.

In dense small diameter brush with few or no large trees, or when cutting is vine entangled, reduce the base time by 30%.

Example problem:

Calculate the windrow piling production of a D7R Series II with Balderson Rake in level terrain, no grubbing, and average mixture of hardwoods and softwoods where the average tree count per hectare (2.47 acres) is:

Diameter Range	Less than 30 cm (1 ft) "B"	31-60 cm (1-2 ft) "N ₁ "	61-90 cm (2-3 ft) "N ₂ "	91-120 cm (3-4 ft) "N ₃ "	121-180 cm (4-6 ft) "N ₄ "	Sum Dia's Above 180 cm (6 ft) "D"
Number of Trees	1100	35	6	6	2	0

Solution:

$$\begin{aligned}
 T &= B + M_1N_1 + M_2N_2 + M_3N_3 + M_4N_4 + DF \\
 &= 125 + 0.4(35) + 0.6(6) + 2.5(6) + 5.0(2) + [DF=0] \\
 &= 42.6 \\
 &= 177.6 \text{ minutes/hectare (72 min/acre)}
 \end{aligned}$$



To find the number of machines required for each operation, use the formula:

$$\text{Hr/hectare (acre)} \times \text{number of hectares (acres)} = \text{number of machines needed}^*$$

*Average machine production for all operation in hr/hectare (acre).

To cost estimate each method or phase of operation, use this calculation:

$$\text{Owning and Operating cost/hr} \times \text{hr/hectare (acre)} \times \text{number of hectares (acres)} = \text{cost}$$

Because of the many variables that increase or decrease production, these formulas should be considered only as guidelines in arriving at a rough production estimate. This estimate should be tempered by personal judgment based on past experience and personal knowledge of the area.

- Rome
- Balderson

ROME K/G BLADES Tractors Equipped with CAT C-Frame

Tractor Model		D6M	D6R	D7R	D8K & D8R	D8L
Blade Model		KGBA5H	KGBA6H	KGBA7H	KGBA8	KGBA8L
Overall Width, Mounted	m	3.29	3.29	3.40	3.76	3.88
	ft	10'9.5"	10'9.5"	11'2"	12'4"	12'9"
Weight	kg	1600	1600	2364	3090	3157
	lb	3520	3520	5200	6820	6960

ROME K/G BLADES Tractors Equipped with Rome C-Frame

Tractor Model		D6M LGP	D6R LGP	D6R	D7R LGP	D7R	D7R	D8K*	D8K
Blade Model		KB5HLGP	KGB6HLGP	KGB6CH	KGB7HLGP	KGB7HTCA	KGB7H	KGB8KTC	KGB8K
Overall Width, Mounted	m	3.89	3.89	3.16	3.96	3.40	3.40	3.76	3.76
	ft	12'9"	12'9"	10'4.5"	13'0"	11'2"	11'2"	12'4"	12'4"
Weight	kg	2140	2140	2282	3770	3572	3420	5320	5160
	lb	4708	4708	5030	8310	7860	7530	11,730	11,380

*Equipped with Caterpillar Tilt Cylinder

BALDERSON BLADE RAKES

Tractor Model & Dozer		6A	D6R 6S	6SLGP	7A	D7R 7S	7SLGP
Raking Width	m	3.3	2.62	3.18	3.72	3.18	3.66
	ft	10'10"	8'6"	10'5"	12'3"	10'5"	12'
Opening at Tooth Tips	mm	356	305	310	406	381	381
	in	14"	12"	12.22"	16"	15"	15"
Tooth Penetration	mm	432	457	406	559	559	559
	ft/in	17"	18"	16"	1'10"	1'10"	1'10"
Total Weight	kg	718	675	825	1144	1245	1119
	lb	1585	1490	1820	2525	2470	2470

BALDERSON RAKES FOR WHEEL LOADERS

Wheel Loader Model and Rake type		914G Loader Rake	924F Loader Rake	928G Loader Rake	938G Loader Rake	950G/962G Loader Rake	966G/972G Loader Rake
Raking Width	mm	2210	2165	2837	2845	3048	3353
	ft	7'3"	7'1"	9'4"	9'4"	10'0"	11'0"
Tooth Penetration	mm	762	762	914	914	965	1143
	ft	2'6"	2'6"	3'0"	3'0"	3'2"	3'9"
Opening at Tooth Tips	mm	318	324	349	298	298	330
	in	12.75"	12.8"	13.8"	11.75"	11.75"	13"
Rake Weight	kg	770	760	1420	1450	1590	2210
	lb	1700	1675	3130	3200	3500	4880

BALDERSON RAKES FOR TRACK LOADERS

Track Loader Model and Rake type		953C Loader Rake	963B Loader Rake
Raking Width	mm	2845	2388
	ft	9'4"	7'10"
Tooth Penetration	mm	635	635
	ft	2'1"	2'1"
Opening at Tooth Tips	mm	298	330
	in	11.75"	13"
Rake Weight	kg	1450	1450
	lb	3200	3200

This listing is not all-inclusive. Contact Balderson for special attachment needs.

WASTE DISPOSAL

CONTENTS

Introduction	27-1
Landfill methods	27-1
Equipment selection	27-2
Track-Type Tractors	27-2
Track Loaders	27-2
Landfill Compactors	27-2
Wheel Loaders	27-3
Wheel Tractor-Scrapers	27-3
Machine selection factors	27-3
Refuse densities	27-4
Compaction factors	27-5
Compaction comparison	27-6
Compactor production	27-6
Landfill estimating (example problems)	27-6

INTRODUCTION

An increasing volume of refuse is generated by every person, commercial entity and household day after day ... 365 days a year. Disposal of this waste is a major problem worldwide. Increased governmental legislation designed to protect the environment and rising transportation and land acquisition costs have made waste disposal a significant user of earthmoving and specialty mobile equipment.

The most commonly accepted disposal method is burying refuse in a sanitary landfill. A sanitary landfill protects the environment by disposing solid waste on land in an engineered cell. Building a cell involves spreading the waste in thin layers, compacting it to the smallest practical volume, covering it with soil by the end of each working day, and compacting the cover material. Proper equipment selection and operating technique can maximize refuse and cover compaction and extend the operational landfill life.

27

LANDFILL METHODS

There are three basic landfill methods:

In the *area* method, waste is usually deposited at the toe of the previously compacted cell and then spread and compacted. This method is attractive for landfills receiving over 450 metric tons (500 tons) of refuse per day because it reduces truck unloading congestion. Cover material is normally handled by wheel tractor-scrappers from nearby borrow sites.

The *trench* method is normally found at smaller landfills where the ground water table is deep. A trench is excavated and refuse is deposited and compacted within it. Excavated material becomes the cover material. Since the trench working face is narrow, truck congestion can occur. This method is usually attractive to landfills receiving under 450 metric tons (500 tons) of refuse per day.

- Track-Type Tractors
- Track Loaders
- Landfill Compactors

The *ramp* method combines the characteristics of both area and trench designs. Refuse is dumped, spread and compacted on existing slopes and covered with material excavated directly in front of the working face. The excavated area becomes part of the next cell. This is a good way for a landfill to begin operation with a minimum of equipment expenditures.

EQUIPMENT SELECTION

A landfill's largest single cost for daily operation is purchasing, operating and maintaining the mobile equipment. Undersized, inadequate or unreliable equipment results in breakdowns, higher operating costs and improper landfill operation.

Landfill equipment performs three distinct functions:

1. Waste handling and compaction equipment dispose of the waste. Track-type tractors, track loaders, and steel-wheeled landfill compactors are the primary machines.
2. Cover material handling machines provide daily cover requirements. If supplying cover material is a machine's sole function at a landfill, it can be selected on the basis of normal earthmoving considerations, such as material characteristics, distance to borrow areas, volume to be transported, and other basic earthmoving principles, i.e., maximizing earth movement in the least amount of time at the lowest cost per yard.
3. Support equipment includes motor graders, hydraulic excavators, water trucks, air compressors, service vehicles, water pumps, generators and any other necessary equipment.

Track-Type Tractors

The track-type tractor is the most popular and versatile machine on a sanitary landfill. They not only spread and compact refuse and cover material, they also prepare the site, rip cover material, build haul roads, knock down trees, remove stumps, and work in virtually all weather conditions. They are well-suited for all three landfill methods (area, ramp, and trench).

The crawler tractor can achieve compaction densities of 475 to 590 kg/m³ (800-1000 lb/yd³). Maximum compaction is achieved when it works on a 3:1 slope, permitting the grousers to rip and tear while pushing and compacting waste up-slope. Economic limit of cover or waste movement by a track-type tractor is normally under 90 m (300 ft).

Track Loaders

Track loaders are highly versatile allowing them to perform many applications. Small landfills under 135 metric tons (150 tons) per day generally utilize a minimum amount of equipment. Track loaders can serve both the waste handling and cover material functions.

The track loader is an ideal machine for the trench method. Since the bucket does not extend outside the tracks, it can obtain full compaction to the trench walls. Rippers can be attached to handle frozen cover material. Compaction densities are similar to or slightly higher than the track-type tractor — 475 to 590 kg/m³ (800-1000 lb/yd³). Many people believe track loaders equipped with single grouser shoes provide maximum demolition and compaction densities. Loading the bucket during compaction passes increases weight helping achieve higher densities.

Equipping track loaders with multi-purpose buckets increases their versatility in single machine applications, allowing the operator to selectively grapple items out of the working face.

Track loaders are also ideal for transfer stations. The machine's weight compacts the trash reducing volume and increases density. Wider and larger capacity buckets from Balderson Special Attachments are needed to fully utilize the capabilities of the track loader in this application.

Landfill Compactors (Steel-Wheeled)

Landfill compactors are specialized pieces of equipment effective in spreading and compacting large volumes of waste. Compactors offer higher operational speeds than track machines. This is the recommended machine if more than one spreading and compaction machine is needed and waste does not have to be pushed more than 90 m (300 ft).

Landfill compactors over 20 410 kg (45,000 lb) operating weight achieve the highest compaction levels — from 710 to 950 kg/m³ (1200-1600 lb/yd³).

Landfill compactors normally operate on slopes no steeper than 4:1 due to reduced compaction and operational safety. Compactors should not be used to excavate cover material.

- Wheel Loaders
- Wheel Tractor-Scrapers
- Machine Selection Factors

Wheel Loaders

Although not recommended as a waste handling and compaction machine, wheel loaders are used by those communities sharing a single machine which travels from landfill to landfill. Versatility and mobility are the primary wheel loader advantages. In landfills over 272 metric tons (300 tons) per day, wheel loaders will sometimes be used to perform general clean-up tasks. Wheel loaders are also popular in transfer stations to load and separate refuse. Special foam-filled tires should be considered due to the constant threat of tire puncture. However, foam filled tires will have reduced ton-mile-per hour capabilities.

Wheel loaders can achieve compaction densities of 530 to 650 kg/m³ (900-1100 lb/yd³). A disadvantage of wheel loaders is that they can leave ruts in the refuse, requiring extra cover material.

Wheel Tractor-Scrapers

A scraper can be used to excavate trenches for site preparation, but usually performs a cover operation at a landfill and is most economical at distances over 185 m (600 ft). A scraper should be selected as if it were performing a typical earthmoving job.

Preferably, the scraper unloads the cover material close to the working face, either at the base or top. The cover material is then spread by the machine(s) working on the refuse. This reduces the possibility of tire damage from driving over the refuse. Foam filled tires are not recommended for scrapers due to the high travel speeds. Since excavating and transporting cover material is a major expense at a landfill, scrapers with work alone capability have been the most popular.

Machine Selection Factors

Selecting the type, size, quantity, and combination of machines required to spread, compact, and cover varying daily refuse volumes is determined by the following parameters:

1. Amount and type of waste to be handled (daily tonnage)
2. Amount and type of soil cover to be handled
3. Distance cover material to be transported
4. Weather conditions
5. Compaction requirements
6. Landfill method utilized
7. Supplemental tasks
8. Budget
9. Growth

A. *Daily tonnage and type of waste* — Amount of waste produced by a community is the major variable in selecting the appropriate size machine. The chart serves as a guideline in sizing a landfill machine. For example, if a community generates approximately 180 metric tons (200 tons) of refuse per day, a D6 or 963 and a 816 Landfill Compactor should be considered.

WASTE EQUIPMENT SELECTION BASED UPON POPULATION AND DAILY REFUSE TONNAGE

Population	Metric Tons/Day	U.S. Tons/Day	Machine(s) Required
0-20,000	0-45	0-50	D3 or 933
20,000-60,000	45-136	50-150	D4 or 939 and an 816
60,000-100,000	136-226	150-250	D5 or D6 or 953 and 816
100,000-140,000	226-317	250-350	D6 or D7 or 963 and 816
140,000-200,000	317-453	350-500	D7 or D8 or 973 and 816
200,000-300,000	453-680	500-750	D8 or D9 and 826
300,000-more	680-more	750-more	D9, D10 and 836/variety of support equipment

NOTE: Daily tonnage figures are based on 2.26 kg (5 lb) of residential refuse per person per day. The amount of waste/person/day can vary depending on the community and should be adjusted to the individual community.

Type of waste to be handled will strongly influence machine selection. The major solid waste components for a community should be identified and the proper machine chosen based on the type of waste and the compaction desired. For example, if the site receives a high proportion of noncompactible heavy industrial waste (rocks, bricks, concrete, reinforcing rod, etc.) a compactor might not achieve normal compaction densities and the pushing and tractive ability of a track-type tractor may be needed. However, a small track-type tractor has more difficulty compacting bulk waste such as washing machines and telephone poles than a landfill compactor.

Waste varies from location to location, even within a community; however, the following figures are representative in the U.S.:

Characterization of Domestic — Household Waste	
Component	Percent by Weight
Paper	42
Food	16
Glass	14
Metal	12
Plastics	5
Wood	5
Rubber and Leather	4
Textiles	2

NOTE: Moisture content can have a significant effect on weight characteristics. Field tests have indicated moisture content can vary from 10-80% during dry and wet seasons.

B. Amount and type of cover material to be handled — Although landfill size and type will vary, a rule of thumb for estimating needed cover material is one cubic meter (cubic yard) of cover material for every four cubic meters (or cubic yards) of in-place compacted waste. That is, about 20-25% of a sanitary landfill's volume consists of soil used for cover (including daily and final covering). On smaller landfills, the percentage of soil could be as high as 50% to meet reasonable cover requirements.

It is important to remember that cover material also occupies landfill space reducing the volume available for refuse. For example a landfill with 1 900 000 m³ (2,500,000 yd³) of total volume would provide for disposing of 1 520 000 m³ (2,000,000 yd³) of refuse and allow 380 000 m³ (500,000 yd³) of cover material. This example considers one cubic yard of cover for every 4 cubic yards of in place compacted waste.

The type of cover material can also be important. If the material is sandy or highly abrasive, a rubber tired wheel loader or scraper might be considered rather than a track-type unit.

C. Distance cover material is to be transported will have a large effect on cover equipment selection. The following economic limits or guidelines are recommended for cover material movement. The quantity of material to be moved and the time available must be considered when using these guidelines.

Track-type tractor	0-90 m	(0-300 ft)
Track loader	0-152 m	(0-500 ft)
Wheel loader	0-185 m	(0-600 ft)
Wheel tractor-scraper over 185 m	(over 600 ft)	

D. Weather conditions — when working in inclement weather, the tractive capability of a track-type machine may be necessary for poor underfoot conditions or to rip frozen cover material.

E. Compaction requirements — are becoming critical as extended landfill life is sought. If high density is desired, then a compactor may be necessary.

REFUSE DENSITIES

Generally, loose residential and commercial refuse weighs 150-180 kg/m³ (250-300 lb/yd³). A refuse collection vehicle will increase this density to 237-415 kg/m³ (400-700 lb/yd³). In-place landfill density can vary from 355-890 kg/m³ (600-1500 lb/yd³), depending on the compactive effort applied to the refuse. Landfill sites that accept a high percentage of demolition waste can have densities up to 1485 kg/m³ (2500 lb/yd³). Cover material will generally raise fill densities 60-120 kg/m³ (100-200 lb/yd³) over the figures given above.

	Weight of Refuse	
	kg/m ³	lb/yd ³
Loose Refuse:	148-178	250-300
Packer Truck	237-415	400-700
Fill Density:	356-890	600-1500
Refuse and Cover:	415-1009	700-1700

FACTORS GOVERNING COMPACTION

Assuming equal machine weight, regardless of the type of machine, the following factors (1-4) affect compaction:

1. Refuse Layer Thickness — The depth of each compacted layer is perhaps the single most important controllable factor influencing density. To obtain maximum density, waste should be spread and compacted in layers **not exceeding a depth of 610 mm (2 ft)**. Thicker layers will reduce the density that a machine can develop in a given number of passes. (Density figures shown do not include cover material.)

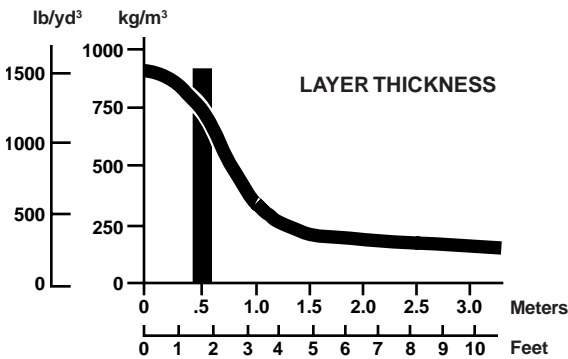

2. Number of passes made over the refuse also affects density. Regardless of the type of machine used, the unit should make 3-4 passes to achieve optimum density. The following graph illustrates that more than four passes result in little additional compactive effort. The added expense of additional passes is not justified by the incremental increase in density.

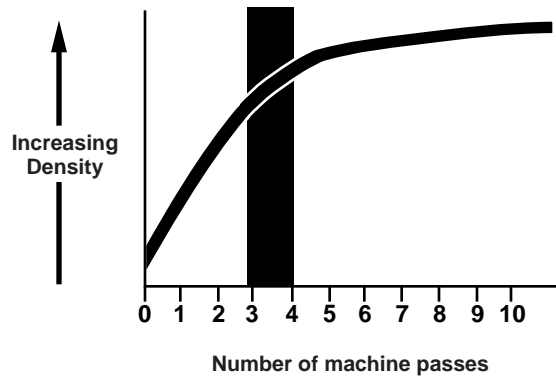

3. Slope — Maximum compactive effort by a track-type unit is achieved by working the waste on a slope of 3:1. Track-type machines achieve higher densities by grinding and shredding the refuse into smaller pieces as they climb a slope.

Just the opposite is true for the landfill compactor. The flatter the slope, the better the compaction. This is because the weight of the landfill compactor is more efficiently utilized and concentrated when working on a flat surface.

4. Moisture Content — has been shown to have a significant effect on compacted density. It is believed that water tends to weaken the bridging characteristics of refuse, particularly paper such as large pieces of cardboard, etc., thereby allowing tighter consolidation. The water may also act as a lubricant — much as it does for soils. A minimum amount of moisture can increase refuse compaction density by 10%.

The optimum moisture content for maximum compaction of household refuse appears to be around 50% by weight. Field tests show actual moisture contents varying from 10-80% during dry and wet seasons. Although higher moisture content can provide higher in-place densities, the chance of leachate formation also increases.

COMPACTION COMPARISON ESTIMATE

The following graph may be used as a rule of thumb for the compactive ranges of various types of landfill machines if proper operating technique is employed.

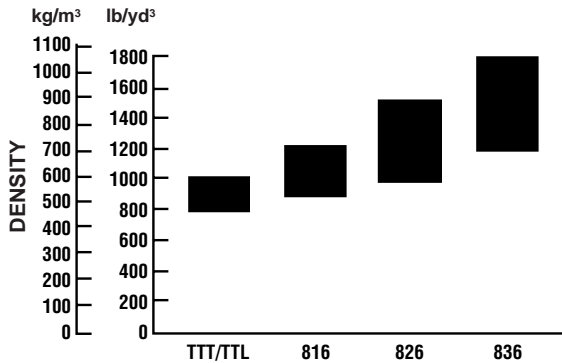

EXAMPLE OF INCREASED COMPACTION ON POTENTIAL LANDFILL LIFE

Landfill refuse capacity	1 530 000 m³ (2,000,000 yd³)
Operating days	260
Daily volume	365 metric tons (400 tons)
Yearly volume	94 328 metric tons (104,000 tons)

Compaction	Landfill Life	Gain
590 kg/m³ 1000 lb/yd³	9.6 years	0
710 kg/m³ 1200 lb/yd³	11.5 years	1.9 years
830 kg/m³ 1400 lb/yd³	13.4 years	3.8 years
950 kg/m³ 1600 lb/yd³	15.3 years	5.7 years
1070 kg/m³ 1800 lb/yd³	17.2 years	7.6 years

In this example, each 120 kg (200 lb) increase in refuse density results in an additional 1.9 years of landfill life. Also this example is exclusive of cover requirements.

COMPACTOR PRODUCTION GUIDELINES

Model	Tons/Day		Tons/Hr	
	Metric	U.S.	Metric	U.S.
836	1016	1000	127	125
826G	813	800	102	100
816F	508	500	63.5	62.5

All models are pushing refuse 61 m (200 ft) spreading and making 3 to 4 passes to compact. A pass is defined as a machine traveling over refuse one time in one direction.

- F. *Landfill method utilized* — impacts the equipment needed. The area method, which is generally suited for flat or gradual sloping surfaces will get maximum compaction effort with a compactor. The trench method may require a track loader due to its excavating and tractive capabilities.
- G. *Supplemental tasks* — should be reviewed before selecting a landfill machine. Will the machine be required for site clearing, maintaining access roads, excavating, etc.? Auxiliary duties may require additional machine capability and/or attachments. If versatility is the key consideration, a track-type machine again becomes the logical choice.
- H. *Budget* — Smaller landfill operations with limited budgets may have to consider single machine versatility ahead of specialized machines or multiple units.
- I. *Growth* — Future increases in refuse volume must be considered to properly size machines.

LANDFILL ESTIMATING

Example Problem #1

A professional engineer has developed a small, rural sanitary landfill master plan. The local legislative regulatory agency has approved the plan and site.

Assume:

- Topography: flat
- Land availability: area has several suitable sites at nominal price
- Population served: 30,000
- Projected population in 3 years: 40,000
- Current daily refuse volume: ?
- Type of refuse: mostly household, some commercial
- Operation: propose 8 hours/day, 5½ days/week
- Present equipment: none — new site

What would your comments and recommendations be on the following?:

- a. Probable amount of refuse generated daily?
- b. Type of machine for the proposed SLF?
- c. Size of machine for the proposed SLF?

Solution

- a. At three year projected population — 2.26 kg/day (5 lb/day) per person × 40,000 people = 90.4 metric tons (100 tons) daily.
- b. Track loader — excavating ability, single machine application based on tonnage requirements.
- c. 953B handle current refuse, and has extra capacity for future growth. Small compactor if additional compaction is required.

Example Problem #2

Existing sanitary landfill has been in operation for several years.

Assume:

Type of operation: area fill

Cover material: suitable material within 90 m (300 ft).

Current daily refuse volume: 500 metric tons (550 tons)

Anticipated daily refuse volume in 3 years: 680 metric tons (750 tons)

Type of refuse: household, commercial, large amount of brush and building demolition debris

Land availability: limited, very expensive

Available Refuse Volume: 3 249 125 m³ (4,250,000 yd³)

Operation: 8 hours/days, 5½ days/week

Present equipment: D8 (3 years old)

What would your comments and recommendations be on the following:

- What range of in-place densities could be expected using a track-type tractor; a Cat steel-wheeled landfill compactor?
- What effect does machine selection have on site life?
- What are the advantages and limitations of steel-wheeled landfill compactors?
- What are the advantages and limitations of track-type units?
- How many machines should be used on the site?
- What type should they be?
- What size should they be?

Solution

- The Track-Type Tractor will achieve 475 to 595 kg/m³ (800 to 1,000 lb/yd³) in-place density. The Cat steel-wheeled landfill compactor will achieve 595 to 830 kg/m³ (1,000 to 1,400 lb/yd³) in-place density.
- There are 3 249 125 m³ (4,250,000 yd³) available. 500 metric tons (550 tons) per day is how many m³ (yd³)? Assume a minimum density of 475 kg/m³ (800 lb/yd³).

$$500 \text{ metric tons/day} \times \frac{1000 \text{ kg/metric ton}}{475 \text{ kg/m}^3} = 1052 \text{ m}^3/\text{day}$$

$$550 \text{ tons/day} \times \frac{2000 \text{ lb/ton}}{800 \text{ lb/yd}^3} = 1,375 \text{ yd}^3/\text{day}$$

$$5.5 \text{ days/week} \times 52 \text{ weeks/year} = 286 \text{ days/year}$$

$$\text{Yearly volume: } 1,052 \times 286 = 300\,872 \text{ m}^3$$

$$1,375 \times 286 = 393,250 \text{ yd}^3$$

Landfill life at this density:

$$\frac{3\,250\,000 \text{ m}^3}{300\,872 \text{ m}^3/\text{year}} = \frac{4,250,000 \text{ yd}^3}{393,250 \text{ yd}^3/\text{year}} = 10.8 \text{ years}$$

Similar calculations are performed to generate the following tables.

500 METRIC TONS/DAY (550 TONS/DAY)			
kg/m ³	Density		Landfill Life (years)
	kg/m ³	lb/yd ³	
475	800	1000	10.8
595	1000	1400	13.5
715	1200	1600	16.2
835	1400	1600	18.9
950	1600	1600	21.6

680 METRIC TONS/DAY (750 TONS/DAY)			
kg/m ³	Density		Landfill Life (years)
	kg/m ³	lb/yd ³	
475	800	1000	7.9
595	1000	1400	9.9
715	1200	1600	11.9
835	1400	1600	13.9
950	1600	1600	15.9

From the tables we determine that a track-type tractor, at 500 metric tons per day (550 tons/day), will provide 13.5 landfill life years at 595 kg/m³ (1,000 lb/yd³). Compaction will extend that life 5.4 years to 18.9 years at 835 kg/m³ (1,400 lb/yd³).

Proper compaction techniques are necessary to achieve the higher refuse densities and increase landfill life.

- c. Advantages: Provides highest compaction densities extending landfill life.
Limitations: Specialty unit designed to spread and compact — does not excavate virgin material economically, but can handle stockpile cover material.
- d. Advantages: most versatile unit, well suited to site preparation, finishing and access road construction and maintenance; all weather machines with excellent tractive ability. Limitation: compaction — cannot achieve the in-place refuse densities of the specialized landfill compactors.
- e. Minimum of two. Additional equipment would depend on supplemental tasks.
- f. Track-type tractor — for earthmoving and refuse spreading work; steel-wheeled compactor-quantity of refuse and land cost would justify.
- g. D8 — keeping existing unit; D9 — when new tractor is necessary; 826G — with large amount of demolition debris and brush and projected increase in tonnage would justify 826G over 816F.

TABLES

SWELL — VOIDS — LOAD FACTORS

SWELL (%)	VOIDS (%)	LOAD FACTOR
5	4.8	.952
10	9.1	.909
15	13.0	.870
20	16.7	.833
25	20.0	.800
30	23.1	.769
35	25.9	.741
40	28.6	.714
45	31.0	.690
50	33.3	.667
55	35.5	.645
60	37.5	.625
65	39.4	.606
70	41.2	.588
75	42.9	.571
80	44.4	.556
85	45.9	.541
90	47.4	.526
95	48.7	.513
100	50.0	.500

BUCKET FILL FACTORS

Loose Material	Fill Factor
Mixed Moist Aggregates	95-100%
Uniform Aggregates up to 3 mm (1/8")	95-100
3 mm-9 mm (1/8"-3/8")	90-95
12 mm-20 mm (1/2"-3/4")	85-90
24 mm (1") and over	85-90
Blasted Rock	
Well Blasted	80-95%
Average Blasted	75-90
Poorly Blasted	60-75
Other	
Rock Dirt Mixtures	100-120%
Moist Loam	100-110
Soil, Boulders, Roots	80-100
Cemented Materials	85-95

NOTE: Loader bucket fill factors are affected by bucket penetration, breakout force, rackback angle, bucket profile and ground engaging tools such as bucket teeth or bolt-on replaceable cutting edges.

NOTE: For bucket fill factors for hydraulic excavators, see bucket payloads in the hydraulic excavator section.

TYPICAL ROLLING RESISTANCE FACTORS

Various tire sizes and inflation pressures will greatly reduce or increase the rolling resistance. The values in this table are approximate, particularly for the track and track + tire machines. These values can be used for estimating purposes when specific performance information on particular equipment and given soil conditions is not available. See Mining and Earthmoving Section for more detail.

UNDERFOOTING	ROLLING RESISTANCE, PERCENT*			
	Tires Bias	Tires Radial	Track **	Track +Tires
A very hard, smooth roadway, concrete, cold asphalt or dirt surface, no penetration or flexing	1.5%*	1.2%	0%	1.0%
A hard, smooth, stabilized surfaced roadway without penetration under load, watered, maintained	2.0%	1.7%	0%	1.2%
A firm, smooth, rolling roadway with dirt or light surfacing, flexing slightly under load or undulating, maintained fairly regularly, watered	3.0%	2.5%	0%	1.8%
A dirt roadway, rutted or flexing under load, little maintenance, no water, 25 mm (1") tire penetration or flexing	4.0%	4.0%	0%	2.4%
A dirt roadway, rutted or flexing under load, little maintenance, no water, 50 mm (2") tire penetration or flexing	5.0%	5.0%	0%	3.0%
Rutted dirt roadway, soft under travel, no maintenance, no stabilization, 100 mm (4") tire penetration or flexing	8.0%	8.0%	0%	4.8%
Loose sand or gravel	10.0%	10.0%	2%	7.0%
Rutted dirt roadway, soft under travel, no maintenance, no stabilization, 200 mm (8") tire penetration and flexing	14.0%	14.0%	5%	10.0%
Very soft, muddy, rutted roadway, 300 mm (12") tire penetration, no flexing	20.0%	20.0%	8%	15.0%

*Percent of combined machine weight.

**Assumes drag load has been subtracted to give Drawbar Pull for good to moderate conditions. Some resistance added for very soft conditions.

ANGLE OF REPOSE OF VARIOUS MATERIALS

MATERIAL	ANGLE BETWEEN HORIZONTAL AND SLOPE OF HEAPED PILE	
	Ratio	Degrees
Coal, industrial	1.4:1—1.3:1	35-38
Common earth, Dry	2.8:1—1.0:1	20-45
Moist	2.1:1—1.0:1	25-45
Wet	2.1:1—1.7:1	25-30
Gravel, Round to angular	1.7:1—0.9:1	30-50
Sand & clay	2.8:1—1.4:1	20-35
Sand, Dry	2.8:1—1.7:1	20-30
Moist	1.8:1—1.0:1	30-45
Wet	2.8:1—1.0:1	20-45

Tables

ROUND REINFORCED CONCRETE PIPE APPROXIMATE WEIGHT PER FOOT

INSIDE DIAMETER		WEIGHT PER FT.	
mm	ft/in	kg	lb
305	12"	42	93
380	15"	58	127
460	18"	76	168
530	1'9"	97	214
610	2'0"	120	265
685	2'3"	146	322
760	2'6"	174	384
840	2'9"	205	452
915	3'0"	238	524
1070	3'6"	311	686
1220	4'0"	393	867
1370	4'6"	485	1069
1525	5'0"	588	1295
1675	5'6"	699	1542
1830	6'0"	821	1811
1980	6'6"	952	2100
2135	7'0"	1093	2409
2285	7'6"	1242	2740
2440	8'0"	1402	3090
2590	8'6"	1578	3480
2740	9'0"	1753	3865

NOTE: Table courtesy of American Concrete Pipe Assn.

COEFFICIENT OF TRACTION FACTORS

MATERIAL	TRACTION FACTORS	
	Rubber Tires	Tracks
Concrete	.90	.45
Clay loam, dry	.55	.90
Clay loam, wet	.45	.70
Rutted clay loam	.40	.70
Dry sand	.20	.30
Wet sand	.40	.50
Quarry pit	.65	.55
Gravel road (loose not hard)	.36	.50
Packed snow	.20	.27
Ice	.12	.12
Semi-skeleton shoes		
Firm earth	.55	.90
Loose earth	.45	.60
Coal, stockpiled	.45	.60

NOTE: The elevated sprocket design Track-type Tractors (D11N, D10N, D9N and D8N), with their suspended undercarriage, provide up to 15% more efficient tractive effort than rigid tracked Track-type Tractors.

SPEED CONVERSION

km/h Equivalents in m/min				MPH Equivalents in FPM			
km/h	m/min	km/h	m/min	mph	fpm	mph	fpm
1	16.7	21	350.0	1	88	21	1848
2	33.3	22	366.7	2	176	22	1936
3	50.0	23	383.3	3	264	23	2024
4	66.7	24	400.0	4	352	24	2112
5	83.3	25	416.7	5	440	25	2200
6	100.0	26	433.3	6	528	26	2288
7	116.7	27	450.0	7	616	27	2376
8	133.3	28	466.7	8	704	28	2464
9	150.0	29	483.3	9	792	29	2552
10	166.7	30	500.0	10	880	30	2640
11	183.3	31	516.7	11	968	31	2728
12	200.0	32	533.3	12	1056	32	2816
13	216.7	33	550.0	13	1144	33	2904
14	233.3	34	566.7	14	1232	34	2992
15	250.0	35	583.3	15	1320	35	3080
16	266.7	36	600.0	16	1408	36	3168
17	283.3	37	616.7	17	1496	37	3256
18	300.0	38	633.3	18	1584	38	3344
19	316.7	39	650.0	19	1672	39	3432
20	333.3	40	666.7	20	1760	40	3520

NOTE: Since 1 km/h equals 16.7 m/min (1000 ÷ 60), to interpolate add 1.67 m/min for each 0.1 km/h.

NOTE: Since 1 mph equals 88 fpm (5280 ÷ 60), to interpolate add 8.8 fpm for every 0.1 mph.

1 mph = 26.9 m/min.

BEARING POWERS

MATERIAL	BEARING POWER			
	Bar	lb/in ²	Metric t/m ²	U.S. tons/ft ²
Rock (semi-shattered)	4.8	70	50	5
Rock (solid)	24.1	350	240	24
Clay, dry	3.8	55	40	4
medium dry	1.9	27	20	2
soft	1.0	14	10	1
Gravel, cemented	7.6	110	80	8
Sand, compact dry	3.8	55	40	4
clean dry	1.9	27	20	2
Quicksand & alluvial soil	0.5	7	5	0.5

AGRICULTURAL COMMODITIES CONVERSION FACTORS

	lb	kg	Metric Ton
1 Bushel of Corn*	56	25.40	0.02540
1 Bushel of Soybean*	60	27.22	0.02721
1 Bushel of Oats*	32	14.51	0.01451
1 Bushel of Wheat*	60	27.22	0.02721
1 Bale of Cotton	478	216.81	0.21681

1 metric ton of Corn	39.37 Bushels*
1 metric ton of Soybean	36.75 Bushels*
1 metric ton of Oats	68.92 Bushels*
1 metric ton of Wheat	36.75 Bushels*
1 metric ton of Cotton	4.61 Bales

*Bushel is a volume measurement, 1 Bushel = 35.24 liters = 9.31 U.S. Gallons. In the agricultural mercantile exchange, the Bushel is widely used for grains as weight. For the above weights, the market assumes a standard density for each type of grain.

CURVE SUPERELEVATION IN PERCENT GRADE, TO PROVIDE NO LATERAL TIRE FORCE

Negotiating curves can generate high lateral tire forces. These forces contribute to high tire wear and ply separation. Superelevating the curve helps eliminate these forces. The amount of superelevation depends on the curve's radius and the speed at which it is negotiated.

The following table is a guide for providing the superelevation necessary to eliminate lateral forces.

Superelevated turns present a danger when slippery. For this reason, curves superelevated over 10% should be used with caution. Unless the proper speed is maintained, matching the elevation of the curve, a vehicle may slide off of the lower edge of the roadway. Superelevated curves should be maintained in good tractive conditions.

TURN RADIUS		Speed	Speed	Speed	Speed	Speed	Speed	Speed	Speed
m	ft	16 km/h 10 mph	24 km/h 15 mph	32 km/h 20 mph	40 km/h 25 mph	48 km/h 30 mph	56 km/h 35 mph	64 km/h 40 mph	72 km/h 45 mph
15.2	50	13%	30%	—	—	—	—	—	—
30.5	100	7%	15%	27%	—	—	—	—	—
45.7	150	4%	10%	18%	28%	—	—	—	—
61.0	200	3%	8%	13%	21%	30%	—	—	—
91.5	300	2%	5%	9%	14%	20%	27%	—	—
152.4	500	1%	3%	5%	8%	12%	16%	21%	27%
213.4	700	1%	2%	4%	6%	9%	12%	15%	19%
304.9	1000	1%	2%	3%	4%	6%	8%	11%	14%

MAXIMUM SPEED ON CURVES FOR VARIOUS SUPERELEVATION GRADES WITH A 0.20 LATERAL COEFFICIENT OF TRACTION

Another approach to superelevated curves is to determine the safe speed for negotiating a turn at a certain lateral tire force. In general, a 20% lateral coefficient of traction is safe for all but slippery conditions. The following table shows maximum speed with various superelevations to maintain a 0.20 lateral coefficient of traction.

TURN RADIUS		Flat Curve		5% Super-elevation		10% Super-elevation	
m	ft	km/h	mph	km/h	mph	km/h	mph
7.6	25	14	9	16	10	17	11
15.2	50	20	12	22	14	24	15
30.5	100	28	17	31	19	34	21
45.7	150	34	21	38	24	42	26
61.0	200	39	24	44	27	48	30
91.5	300	48	30	54	34	59	37
152	500	62	39	70	43	76	47
213	700	74	46	—	—	—	—

A transition "spiral" may be necessary at higher speeds when entering or departing from a superelevated turn.

Tables

WEIGHT* OF MATERIALS	LOOSE		BANK		LOAD FACTORS
	kg/m ³	lb/yd ³	kg/m ³	lb/yd ³	
Basalt	1960	3300	2970	5000	.67
Bauxite, Kaolin	1420	2400	1900	3200	.75
Caliche	1250	2100	2260	3800	.55
Carnotite, uranium ore	1630	2750	2200	3700	.74
Cinders	560	950	860	1450	.66
Clay — Natural bed	1660	2800	2020	3400	.82
Dry	1480	2500	1840	3100	.81
Wet	1660	2800	2080	3500	.80
Clay & gravel — Dry	1420	2400	1660	2800	.85
Wet	1540	2600	1840	3100	.85
Coal — Anthracite, Raw	1190	2000	1600	2700	.74
Washed	1100	1850			.74
Ash, Bituminous Coal	530-650	900-1100	590-890	1000-1500	.93
Bituminous, Raw	950	1600	1280	2150	.74
Washed	830	1400			.74
Decomposed rock —					
75% Rock, 25% Earth	1960	3300	2790	4700	.70
50% Rock, 50% Earth	1720	2900	2280	3850	.75
25% Rock, 75% Earth	1570	2650	1960	3300	.80
Earth — Dry packed	1510	2550	1900	3200	.80
Wet excavated	1600	2700	2020	3400	.79
Loam	1250	2100	1540	2600	.81
Granite — Broken	1660	2800	2730	4600	.61
Gravel — Pitrun	1930	3250	2170	3650	.89
Dry	1510	2550	1690	2850	.89
Dry 6-50 mm (1/4"-2")	1690	2850	1900	3200	.89
Wet 6-50 mm (1/4"-2")	2020	3400	2260	3800	.89
Gypsum — Broken	1810	3050	3170	5350	.57
Crushed	1600	2700	2790	4700	.57
Hematite, iron ore, high grade	1810-2450	4000-5400	2130-2900	4700-6400	.85
Limestone — Broken	1540	2600	2610	4400	.59
Crushed	1540	2600	—	—	—
Magnetite, iron ore	2790	4700	3260	5500	.85
Pyrite, iron ore	2580	4350	3030	5100	.85
Sand — Dry, loose	1420	2400	1600	2700	.89
Damp	1690	2850	1900	3200	.89
Wet	1840	3100	2080	3500	.89
Sand & clay — Loose	1600	2700	2020	3400	.79
Compacted	2400	4050			
Sand & gravel — Dry	1720	2900	1930	3250	.89
Wet	2020	3400	2230	3750	.91
Sandstone	1510	2550	2520	4250	.60
Shale	1250	2100	1660	2800	.75
Slag — Broken	1750	2950	2940	4950	.60
Snow — Dry	130	220			
Wet	520	860			
Stone — Crushed	1600	2700	2670	4500	.60
Taconite	1630-1900	3600-4200	2360-2700	5200-6100	.58
Top Soil	950	1600	1370	2300	.70
Taprock — Broken	1750	2950	2610	4400	.67
Wood Chips**	—	—	—	—	—

*Varies with moisture content, grain size, degree of compaction, etc. Tests must be made to determine exact material characteristics.

**Weights of commercially important wood species can be found in the last pages of the Logging & Forest Products section. To obtain wood weights use the following equations: lb/yd³ = (lb/ft³) × .4 × 27
kg/m³ = (kg/m³) × .4

ALTITUDE DERATION

PERCENT FLYWHEEL HORSEPOWER*
AVAILABLE AT SPECIFIED ALTITUDES

MODEL	0-760 m (0-2500')	760-1500 m (2500-5000')	1500-2300 m (5000-7500')	2300-3000 m (7500-10,000')	3000-3800 m (10,000-12,500')	3800-4600 m (12,500-15,000')
D3C Series III	100	100	100	100	96	88
D3C XL Series III	100	100	100	100	96	88
D3C LGP Series III	100	100	100	100	96	88
D4C Series III	100	100	97	88	81	74
D4C XL Series III	100	100	97	88	81	74
D4C LGP Series III	100	100	97	88	81	74
D5C Series III	100	100	100	100	**	**
D5C XL Series III	100	100	100	100	**	**
D5C LGP Series III	100	100	100	100	**	**
D5M XL & LGP	100	100	100	100	100	100
D5E	100	100	94	87	80	73
D6M XL & LGP	100	100	100	99	91	84
D6D	100*	100*	100*	100*	94*	87*
D6G	100	100	100	100	94	87
D6R	100*	100*	100*	100	94	87
D6R (DIFF STR)	100	100	100	100	100	95
D6R XL	100	100	100	100	94	87
D6R XR	100	100	100	100	94	87
D6R LGP	100	100	100	100	94	87
D6R LGP (DIFF STR)	100	100	100	100	95	87
D7G	100*	100*	100*	94	86	80
D7R	100*	100*	100*	93*	86*	79*
D7R (DIFF STR)	100	100	95	88	81	75
D7R XR	100	100	100	93	86	79
D7R LGP	100	100	100	93	86	79
D7R LGP (DIFF STR)	100	100	95	88	81	75
D8R	100	100	100	100	94	87
D8R LGP	100	100	100	100	94	87
D9R	100	100	100	95	87	80
D10R	100	100	100	100	97	86
D11R	100	100	100	93	86	80
D4E SR	100	100	100	94	87	80
D6E SR	100	100	100	100	94	87
Challenger 35	100	100	100	100	89	82
Challenger 45	100	100	94	86	80	74
Challenger 55	100	100	100	90	82	76
Challenger 65E	100	100	***	***	***	***
Challenger 75E	100	100	***	***	***	***
Challenger 85E	100	100	***	***	***	***
Challenger 95E	100	100	***	***	***	***
Lexion 460/465	**	**	**	**	**	**
Lexion 480/485	**	**	**	**	**	**

*Refer to "Captive Vehicle Engine Fuel Specifications" microfiche at your local dealer.

**Information not available at time of printing.

***Electronically controlled engine, no deration at higher altitudes.

Tables

ALTITUDE DERATION (Continued)

MODEL	0-760 m (0-2500')	760-1500 m (2500-5000')	1500-2300 m (5000-7500')	2300-3000 m (7500-10,000')	3000-3800 m (10,000-12,500')	3800-4600 m (12,500-15,000')
120H NA	100	100	100	100	100	95
120H NA-VHPO	100	100	100	100	100	100
120H STD	100	100	100	100	100	100
120H ES	100	100	100	100	100	100
120H ES-SSO	100	100	100	100	100	100
135H NA	100	100	100	100	95	88
135H NA-VHPO	100	100	100	100	100	98
135H STD	100	100	100	100	100	98
12H NA	100	100	100	100	100	100
12H STD	100	89	83	77	71	65
12H ES	100	100	100	100	100	100
12H ES-SSO	100	100	100	100	100	100
140H NA	100	100	100	100	98	91
140H NA-VHPO	100	100	100	96	88	82
140H STD	100	100	100	100	97	89
140H ES	100	100	100	96	88	82
140H ES-SSO	100	100	100	97	90	83
143H NA	100	100	100	92	85	79
143H NA-SSO	100	100	100	97	90	83
160H NA	100	100	100	98	91	84
160H NA-VHPO	100	100	100	100	97	89
160H STD	100	100	100	97	89	82
160H ES	100	100	100	100	97	89
160H ES-SSO	100	100	100	100	97	90
160H NA	100	100	100	100	93	85
14H GL	100	100	100	98	91	84
14H GL-SSO	100	100	100	99	91	84
16H GL	100	100	100	100	100	100
24H GL	100	100	100	100	93	85
301.5	**	**	**	**	**	**
307B (4M40)	100	100	**	**	**	**
307 (3054)	100	100	89	81	**	**
311B	100	100	90	87	83	**
312B/312B L (3064 T)	100	100	90	87	83	**
312B/312B L (3054 T)	100	100	98	95	92	88
315B (3046 T)	100	100	90	87	83	**
315B L (3046 T)	100	100	90	87	83	**
315B L (3054 T)	100	100	98	95	92	88
318B L/318B LN (3046 T)	100	100	90	87	83	**
M312	100	100	100	100	92	85
M315	100	100	100	100	92	85
M318	100	100	100	100	100	93
M320	100	100	100	100	100	93

*Refer to "Captive Vehicle Engine Fuel Specifications" microfiche at your local dealer.

**Information not available at time of printing.

VHPO = Variable Horsepower Option

SSO = Sound Suppression Option

ALTITUDE DERATION (Continued)

MODEL	0-760 m (0-2500')	760-1500 m (2500-5000')	1500-2300 m (5000-7500')	2300-3000 m (7500-10,000')	3000-3800 m (10,000-12,500')	3800-4600 m (12,500-15,000')
320B (3066 T)	100	100	90	87	83	**
320B L (3066 T)	100	100	90	87	83	**
320B N (3066 T)	100	100	90	87	83	**
320B (3116 T)	100	100	100	100	100	96
320B L (3116 T)	100	100	100	100	100	96
320B N (3116 T)	100	100	100	100	100	96
322B	100	100	100	100	100	97
322B L	100	100	100	100	100	97
322B LN	100	100	100	100	100	97
325B	100	100	100	100	94	87
325B L	100	100	100	100	94	87
325B LN	100	100	100	100	94	87
330B	100	100	100	100	95	92
330B L	100	100	100	100	95	92
330B LN	100	100	100	100	95	92
345B	100	100	100	100	100	**
350	100	100	100	100	96	88
375	100	100	100	93	86	78
5080	100	100	100	93	86	78
5130B◀	100	100	100	100	93	86
5230◀	100	100	100	93	86	79
416C (Turbo normalized)	100	100	98	96	94	88
416C (Turbo)	100	100	98	96	94	88
426C (Turbo)	100	100	98	96	94	88
436C (Turbo)	100	100	98	96	94	88
428C (NA)	100	98	90	84	74	60
428C (Turbo)	100	100	98	96	94	88
438C (Turbo)	100	100	98	96	94	88
446B (Turbo)	100	100	97	91	83	77
515/525	100*	100*	100	100	94	86
528B Cable	100*	100*	100	100	100	93
D4H TSK Series II	100	100	100	100	94	87
517	100	100	100	99	95	87
527	100	100	100	100	99	91
561M	100	100	100	94	86	80
572R	100*	100*	100*	94	86	80
583R	100	100	100	100	94	87
589	100	100	94	87	80	73

*Refer to "Captive Vehicle Engine Fuel Specifications" microfiche at your local dealer.

**Information not available at time of printing.

◀EUI engine — Automatic altitude deration.

Tables

ALTITUDE DERATION (Continued)

MODEL	0-760 m (0-2500')	760-1500 m (2500-5000')	1500-2300 m (5000-7500')	2300-3000 m (7500-10,000')	3000-3800 m (10,000-12,500')	3800-4600 m (12,500-15,000')
621F	100	100	94	87	80	74
631E Series II	100	100	96	88	82	75
651E	100	100	100	95	87	80
627F Tractor	100*	100*	100*	96	89	82
Scraper	100*	100*	100*	92	85	79*
637E Series II Tractor	100	100	96	88	83	76
Scraper	100*	100*	100	95	87	80
657E Tractor	100	100	100	94	88	81
Scraper	100	100	100	95	90	84
613C Series II	100	100	100	100	95	87
615C Series II	100*	100*	95	88	81	74
623F	100	100	94	87	80	74
633E Series II	100	100	96	88	82	75
769D◀	100	100	100	93	88	82
771D◀	100	100	100	93	88	82
773D◀	100	100	100	100	93	85
775D◀	100	100	100	100	93	85
777D◀	100	100	100	100	93	87
785C*◀	100	100	100	93	86	80
789C*◀	100	100	100	93	86	80
793C*◀	100	100	100	100	100	93
776D◀	100	100	100	100	93	87
784C◀	100	100	100	93	86	80
D25D	100	100	100	100	100	95
D30D	100	100	95	88	81	75
D250E Series II	100	100	100	100	100	95
D300E Series II	100	100	95	88	81	75
D350E	100	100	100	100	99	91
D400E	100	100	100	96	88	82
814F	100*	100*	100	100	97	94
824G	100	100	100	97	89	82
834B	100	100	90	80	70	60
844	100	100	100	100	92	85
854G	100	100	100	92	85	77
815B	100*	100*	100	100	97	94
825G	100	100	100	97	89	82
816F	100	100	100	100	97	94
826G	100	100	100	97	89	82
836	100	100	90	80	70	60

*Refer to "Captive Vehicle Engine Fuel Specifications" microfiche at your local dealer.

◀EUI engine — Automatic altitude deration.

ALTITUDE DERATION (Continued)

MODEL	0-760 m (0-2500')	760-1500 m (2500-5000')	1500-2300 m (5000-7500')	2300-3000 m (7500-10,000')	3000-3800 m (10,000-12,500')	3800-4600 m (12,500-15,000')
902	*	*	*	*	*	*
906	*	*	*	*	*	*
914G	100	100	100	89	86	74
924F	100	100	100	100	97	89
928G	100	100	100	100	92	85
930T	100	100	94	87	80	73
938G	100	100	100	100	100	97
950G	100	100	100	*	*	*
962G	100	100	100	*	*	*
966F Series II	100	100	100	100	100	93
970F	100	100	100	100	100	85
980G	100	100	100	100	96	88
988F Series II	100	100	100	94	89	79
990 Series II	100	100	100	100	92	85
992G	100	100	100	92	85	77
994	100	100	100	100	95	88
933C	100	100	100	100	96	88
939C	100	100	100	100	*	*
953C	100	100	100	100	100	100
963B	100	100	100	100	100	100
973	100	100	100	100	100	98
IT14G	100	100	100	89	86	74
IT24F	100	100	100	100	100	93
IT28G	100	100	100	100	92	85
IT38G	100	100	100	96	88	82
IT62G	100	100	100	*	*	*
TH62	100	*	*	*	*	*
TH63	100	*	*	*	*	*
TH82	100	*	*	*	*	*
TH83	100	*	*	*	*	*
TH103	100	*	*	*	*	*
PM-465	100	100	100	*	*	*
PM-565B	100	100	100	*	*	*
RR-250B	100	100	100	100	100	100
SS-250B	100	100	100	100	100	100
RM-350B	100	100	100	*	*	*
AP-200B	100	100-90	90-83	83-73	73-62	62-52
AP-800C	100	100	100-97	97-93	93-89	89-83
AP-1000B	100	100	100-97	97-93	93-89	89-83
AP-650B	100	100	100	97-93	93-89	89-83
AP-1050B	100	100	100-97	97-93	93-89	89-83
AP-1055B	100	100	100-97	97-93	93-89	89-83

*Information not available at time of printing.

Tables

ALTITUDE DERATION (Continued)

MODEL	0-760 m (0-2500')	760-1500 m (2500-5000')	1500-2300 m (5000-7500')	2300-3000 m (7500-10,000')	3000-3800 m (10,000-12,500')	3800-4600 m (12,500-15,000')
BG-210B	100	100	100-97	97-93	93-89	89-83
BG-230	100	100	100-97	97-93	93-89	89-83
BG-240B	100	100	100-97	97-93	93-89	89-83
BG-260C	100	100	100-97	97-93	93-89	89-83
BG-225C	100	100	100-97	97-93	93-89	89-83
BG-245C	100	100	100-97	97-93	93-89	89-83
BG-2455C	100	100	100-97	97-93	93-89	89-83
BG-265B	100	100	100-97	97-93	93-89	89-83
BG-730	100	100	100-97	97-93	93-89	89-83
BG-650	100	100	100-97	97-93	93-89	89-83
CS-323C	100	100	100-97	97-93	93-89	89-83
CS-431C	100	100	100-97	97-93	93-89	89-83
CS-433C	100	100	100-97	97-93	93-89	89-83
CS-531C	*	*	*	*	*	*
CS-533C	100	100	100-97	97-93	93-89	89-83
CS-563C	100	100	100-97	97-93	93-89	89-83
CS-573C	100	100	100-97	97-93	93-89	89-83
CS-583C	100	100	100-97	97-93	93-89	89-83
CP-323C	100	100-90	90-83	83-73	73-62	62-52
CP-433C	100	100	100-97	97-93	93-89	89-83
CP-533C	100	100	100-97	97-93	93-89	89-83
CP-563C	100	100	100-97	97-93	93-89	89-83
CB-214C	100	100	100-97	97-93	93-89	89-83
CB-224C	100	100	100-97	97-93	93-89	89-83
CB-434B	*	*	*	*	*	*
CB-434C	100	100	100-97	97-93	93-89	89-83
CB-534C	100	100	100-97	97-93	93-89	89-83
CB-544	*	*	*	*	*	*
CB-634C	100	100	100-97	97-93	93-89	89-83
PS-150B	100	100-90	90-83	83-73	73-62	62-52
PS-200B	100	100	100-97	83-73	73-62	62-52
PS-360B	*	*	*	*	*	*
PF-300B	100	100	100-97	83-73	73-62	62-52
PS-300B	100	100	100-97	83-73	73-62	62-52
PS-500	100	100	100-97	97-93	93-89	89-83
CB-535B	*	*	*	*	*	*
CB-545B	*	*	*	*	*	*
R1300	*	*	*	*	*	*
R1600	*	*	*	*	*	*
R1700 Series II	*	*	*	*	*	*
R2900	*	*	*	*	*	*
AD40/AE40	*	*	*	*	*	*
69D	*	*	*	*	*	*
73D	*	*	*	*	*	*

*Insufficient data.

**GRADE COMPARISON CHART
DEGREES — PERCENT — SLOPE**

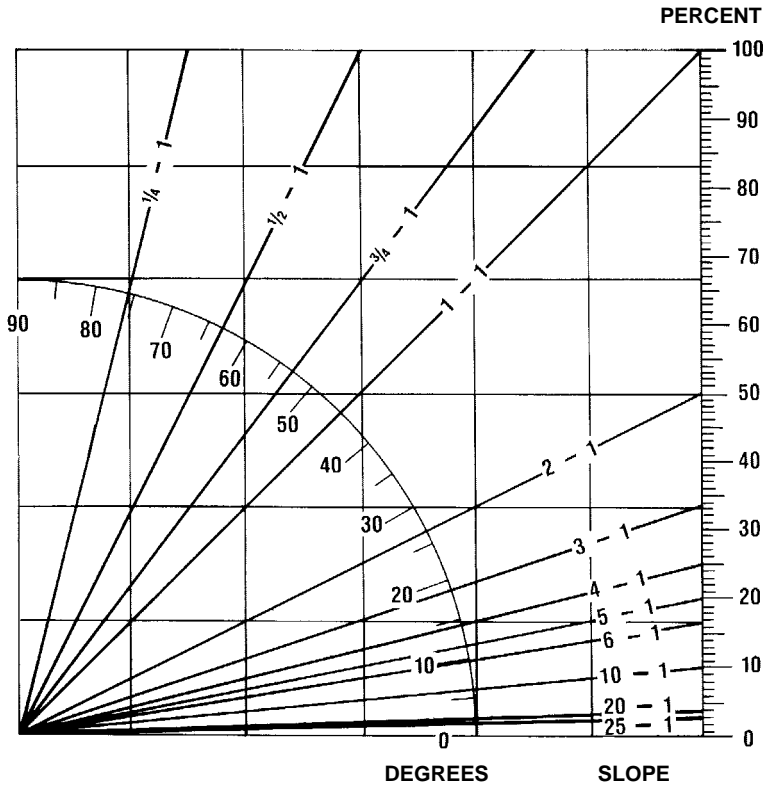

**GRADE IN DEGREES
AND PERCENTS**

DEGREES	PERCENT
1	1.8
2	3.5
3	5.2
4	7.0
5	8.8
6	10.5
7	12.3
8	14.0
9	15.8
10	17.6
11	19.4
12	21.3
13	23.1
14	24.9
15	26.8
16	28.7
17	30.6
18	32.5
19	34.4
20	36.4
21	38.4
22	40.4
23	42.4
24	44.5
25	46.6
26	48.8
27	51.0
28	53.2
29	55.4
30	57.7
31	60.0
32	62.5
33	64.9
34	67.4
35	70.0
36	72.7
37	75.4
38	78.1
39	81.0
40	83.9
41	86.9
42	90.0
43	93.3
44	96.6
45	100.0

Tables

CONVERSION FACTORS

Multiply Metric Unit	By	To Obtain English Unit	Multiply English Unit	By	To Obtain Metric Unit
kilometer (km)	.6214	mile	mile, statute (m)	1.609	kilometer
meter (m)	1.0936	yard	yard (yd)	.9144	meter
meter (m)	3.28	foot	foot (ft)	.3048	meter
centimeter (cm)	.0328	foot	inch (in)	25.4	millimeter
millimeter (mm)	.03937	inch	sq mile (mile ²)	2.590	sq kilometer
sq kilometer (km ²)	.3861	square mile	acre	.4047	hectare
hectare (ha)	2.471	acre	sq foot (ft ²)	.0929	sq meter
sq meter (m ²)	10.764	square foot	sq inch (in ²)	.000645	sq meter
sq meter (m ²)	1550	square inch	cu yard (yd ³)	.7645	cu meter
sq centimeter (cm ²)	.1550	square inch	cu inch (in ³)	16.387	cu centimeter
cu centimeter (cm ³)	.061	cubic inch	cu foot (ft ³)	.0283	cu meter
cu meter (m ³)	1.308	cubic yard	cu inch (in ³)	.0164	liter
liter (L)	61.02	cubic inch	cubic yard (yd ³)	764.55	liter
liter (L)	.001308	cubic yard	mph	1.61	km/h
km/h	.621	mph	Ton — mph	1.459	tkm/h
liter (L)	.2642	U.S. gallon	U.S. gallon (US Gal)	3.785	liter
liter (L)	.22	Imperial gallon	U.S. gallon	.833	Imperial gallon
metric ton (t)	.984	long ton	long ton (lg ton)	1.016	metric ton
metric ton (t)	1.102	short ton	short ton (sh ton)	.907	metric ton
kilogram (kg)	2.205	pound, avdp.	pound (lb)	.4536	kilogram
gram (g or gr)	.0353	ounce, avdp.	ounce (oz)	28.35	gram
kilonewton (kN)	225	pound (force)	pound (lb) (force)	.00445	kilonewton
newton (N)	.225	pound (force)	pound (lb) (force)	4.45	newton
cu centimeter (cm ³)	.0338	fluid ounce	fluid oz (fl oz)	29.57	cu centimeter
kilograms/cu meter	1.686	pounds/cu yd	lb/cu ft (lb/ft ³)	16.018	kg/cu meter
kilograms/cu meter	.062	pounds/cu ft	lb/cu yd (lb/yd ³)	.5933	kg/cu meter
kilograms/sq cm (kg/cm ²)	14.225	pounds/sq in	pounds/sq. in.	.0703	kilogram/sq cm
kilocalorie (kcal)	3.968	Btu	psi	.0689	bar
kilogram-meter (kg•m)	7.233	foot-pound	psi	6.89	kilopascal
meter-kilogram (m•kg)	7.233	pound-foot	Btu	.2520	kilogram-calorie
metric horsepower (CV)	.9863	hp	foot-pound (ft-lb)	.1383	kilogram-meter
kilowatt (kW)	1.341	hp	horsepower (hp)	1.014	metric horsepower
kilopascal (kPa)	.145	psi	horsepower (hp)	.7457	kilowatt
bar	14.5	psi	pounds/cu yd	.0005928	tons/m ³
tons/m ³	1692	pounds/cu yd	pounds (No. 2 diesel fuel)	.1413	U.S. gallon
decaliter	.283	bushel	bushel	3.524	decaliter

NOTE: Some of the above factors have been rounded for convenience. For exact conversion factors please consult International System of Units (SI) table.

Temperature conversion

Degree C

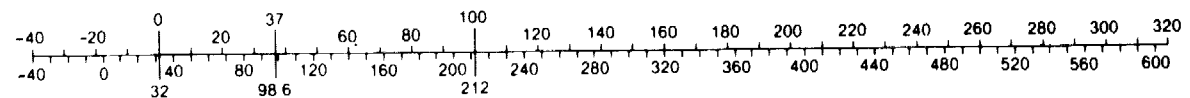

Degree F

$$^{\circ}\text{C} = (^{\circ}\text{F} - 32) \div 1.8$$

$$^{\circ}\text{F} = (\text{C} \times 1.8) + 32$$

METRIC UNIT EQUIVALENTS

1 km	=	1000 m
1 m	=	100 cm
1 cm	=	10 mm
1 km ²	=	100 ha
1 ha	=	10,000 m ²
1 m ²	=	10,000 cm ²
1 cm ²	=	100 mm ²
1 m ³	=	1000 liters
1 liter	=	1000 cm ³
1 metric ton	=	1000 kg
1 quintal	=	100 kg
1 N	=	0.10197 kg•m/s ²
1 kg	=	1000 g
1 g	=	1000 mg
1 bar	=	14.504 psi
1 cal	=	427 kg•m
	=	0.0016 cv•h
	=	0.00116 kw•h
torque unit		
1 CV	=	75 kg•m/s
1 kg/cm ²	=	0.97 atmosph.

ENGLISH UNIT EQUIVALENTS

1 mile	=	1760 yd
1 yd	=	3 ft
1 ft	=	12 in
1 sq mile	=	640 acres
1 acre	=	43,560 sq ft
1 sq ft	=	144 sq in
1 cu ft	=	7.48 gal liq
1 gal	=	231 cu in
	=	4 quarts liq
1 quart	=	32 fl oz
1 fl oz	=	1.80 cu in
1 sh ton	=	2000 lb
1 lg ton	=	2240 lb
1 lb	=	16 oz, avdp
1 Btu	=	778 ft lb
	=	0.000393 hph
	=	0.000293 kwh
1 mechanical hp	=	550 ft-lb/sec
1 atmosph.	=	14.7 lb/in ²

POWER UNIT EQUIVALENTS

kW	=	Kilowatt
hp	=	Mechanical Horsepower
CV	=	Cheval Vapeur (Steam Horsepower)
		French Designation For Metric Horsepower
PS	=	Pferdestärke (Horsepower)
		German Designation For Metric Horsepower
1 hp	=	1.014 CV = 1.014 PS
	=	0.7457 kW
1 PS	=	1 CV = 0.986 hp
	=	0.7355 kW
1 kW	=	1.341 hp
	=	1.36 CV
	=	1.36 PS

Tables

Machine Model	Engine Model	Machine Model	Engine Model	Machine Model	Engine Model
Track-Type Tractors		Motor Graders		Backhoe Loaders	
D3C Series III & Hystat	3046	120H NA	3116 T	416C	3054
D3C XL Series III & Hystat	3046	120H NA (VHP)	3116 TA	426C	3054 T
D3C LGP Series III & Hystat	3046	120H STD	3116 TA	436C	3054 T
D4C Series III & Hystat	3046	120H ES	3116 TA	446B	3114 T
D4C XL Series III & Hystat	3046	135H NA	3116 T	428C	3054
D4C LGP Series III & Hystat	3046	135H NA (VHP)	3116 TA	438C	3054 T
D5C Series III & Hystat	3046 T	135H STD	3116 TA	Wheel Skidders	
D5C XL Series III & Hystat	3046 T	12H NA	3306 T	515	3304 T
D5C LGP Series III & Hystat	3046 T	12H STD	3306	525	3304 T
D5M XL	3116 T	12H ES	3306 T	528B	3306 T
D5M LGP	3116 T	140H NA	3306 T	Track Skidders	
D5E	3306	140H STD	3306 T	517	3304 T
D6M XL	3116 T	140H ES	3306 T	527	3304 T
D6M LGP	3116 T	143H NA	3306 T	Pipelayers	
D6G	3306 T	160H NA	3306 T	561M	3116 T
D6R	3306 T	160H NA (VHP)	3306 TA	572R	3306 T
D6R XL	3306 T	160H STD	3306 T	583R	3406 TA
D6R XL (IG)	3306 T	160H ES	3306 TA	589	3408 TA
D6R XR	3306 T	163H NA	3306 TA	Wheel Tractor-Scrapers	
D6R LGP	3306 T	14H	3306 TA	613C Series II	3116 T
D7G	3306 T	16H	3406 TA	615C Series II	3306 TA
D7R	3306 TA	24H	3412E TA	623F	3406 TA
D7R XR	3306 TA	Excavators		633E Series II	3408 TA
D7R LGP	3306 TA	301.5	3003	621F	3406 TA
D8R	3406C TA	307B	Mitsubishi 4M40EI	631E Series II	3408 TA
D8R LGP	3406C TA	307	3054***	651E	3412 TA
D9R	3408E TA	311B	3064 T	627F Tractor	3406 TA
D10R	3412 TA	312B/312B L	3064 T*	627F Scraper	3306 T
D11R	3508B TA	312B L	3054 T***	637E Series II Tractor	3408 TA
Agricultural Equipment		315B/315B L	3046 T*	637E Series II Scraper	3306 TA
D4E SR	3304 T	315B L	3054 T***	657E Tractor	3412 TA
D6G SR	3306 T	318B L/318B LN	3046 T	657E Scraper	3408 TA
Challenger 35	3116 ATAAC	M312	3054 TA	Construction & Mining Trucks	
Challenger 45	3116 ATAAC	M315	3054 TA	769D	3408E TA
Challenger 55	3126 ATAAC	M318	3116 T	771D	3408E TA
Challenger 65E	3176 ATAAC	M320	3116 T	773D	3412E TA
Challenger 75E	3176 ATAAC	320B/320B L/320B N	3066 T*	775D	3412E TA
Challenger 85E	3196 ATAAC	320B/320B L/320B N/320B S	3116 T**	777D	3508B (EUI) TA
Challenger 95E	3196 ATAAC	322B/322B L	3116 T	785C	3512 (EUI) TA
Lexion 460/465	3126 ATAAC	322B L/322B LN	3116 TA**	789C	3516 (EUI) TA
Lexion 480/485	3176 ATAAC	325B/325B L/325B LN	3116 TA	793C	3516B (EUI) TA
Waste Handling Arrangements		330B/330B L/330B LN	3306 TA	Construction & Mining Tractors	
D6R WDA	3306 T	345B/345B L	3176 ATAAC	776D	3508B (EUI) TA
D7R WDA	3306 TA	350/350 L	3306 ATAAC	784C	3512 (EUI) TA
D8R WDA	3406C TA	375/375 L	3406C ATAAC	Front Shovels	
D9R WDA	3408E TA	5130B	3508 (EUI) TA	5080	3406 TA
D10R WDA	3412 TA	5230	3516 (EUI) TA	5130B	3508 (EUI) TA
953C WDA	3116 T	Front Shovels		5230	3516 (EUI) TA
963B WDA	3116 TA	5080	3406 TA		
973 WDA	3306 T	5130B	3508 (EUI) TA		
		5230	3516 (EUI) TA		

*Japan Sourced.

**Belgium Sourced.

***France Sourced.

IG — Intermediate Gauge

VHP — Variable Horsepower

Machine Model	Engine Model	Machine Model	Engine Model	Machine Model	Engine Model
Articulated Trucks		Integrated Toolcarriers		Compactors	
D25D	3306 TA	IT14G	3054 T	Smooth Drum-Soil	
D30D	3306 TA	IT24F	3114 T	CS-323C	3054
D250E Series II	3306 TA	IT28G	3116 T	CS-431C	3054 T
D300E Series II	3306 TA	IT38G	3126 T	CS-433C	3054 T
D350E	3406 TA	IT62G	3126 TA	CS-531C	3116 T
D400E	3406 TA			CS-533C	3116 T
Wheel Tractors		Telehandlers		CS-563C	3116 T
814F	3306 TA	TH62	3054	CS-573C	3116 T
824G	3406C TA	TH63	3054	CS-583C	3116 T
834B	3408 TA	TH82	3054		
844	3412E TA	TH83	3054 T	Padded Drum-Soil	
854G	3508B TA	TH103	3054 T	CP-323C	3054
Soil Compactors		Paving Products		CP-433C	3054 T
815F	3306 TA	Cold Planers		CP-533C	3116 T
825G	3406C TA	PM-465	3406C	CP-563C	3116 T
Landfill Compactors		PM-565B	3408 TA		
816F	3306 TA	Reclaimer/Stabilizers		Dual Drum-Asphalt	
826G	3406C TA	RR-250B	3406C TA	CB-214C	Hatz 2M41
836	3408 TA	SS-250B	3406C TA	CB-224C	Hatz 2M41
Wheel Loaders		RM-350B	3406D TA	CB-434C/434B	3054
902	3024	Asphalt Pavers		CB-534C	3054 T
906	3034	AP-200B	Hatz 2M40L	CB-544	3054
914G	3054 T	AP-800C	3054 T	CB-634C	3116 T
924F	3114 T	AP-1000B	3116 TA	Single Drum-Combination	
928G	3116 T	AP-650B	3054 TA	CB-535B	3054 T
938G	3126 T	AP-1050B	3116 T	CB-545	3054
950G	3126 TA	AP-1055B	3116 TA	Pneumatic Tire-Asphalt	
962G	3126 TA	BG-210B	3054 T	PS-150B	3054
966F Series II	3306 T	BG-230	3054 T	PS-200B	3054 T
970F	3306 TA	BG-240B	JD4045T*	PS-360B	3054 T
980G	3406 T	BG-260C	3116 TA	PF-300B	3054 T
988F Series II	3408E TA	BG-225C	3054 T	PS-300B	3054 T
990 Series II	3412E TA	BG-245C	3116 TA	PS-500	3208
992G	3508B TA	BG-265B	3116 TA	Underground Mining	
994	3516 TA	BG-2455C	3116 TA	R1300	3306 TA
Track Loaders		Road Wideners		R1600	3176C ATAAC
933C	3046	BG-730	3056 T	R1700 Series II	3176 ATAAC
939C	3046 T	Windrow Elevators		R2900	3406E ATAAC
953C	3116 T	BG-650	3054 T	AD40/AE40 Series II	3408E TA
963B	3116 TA			69D	3408E TA
973	3306 T			73D	3412E TA

*John Deere.

Tables

Engine Model and (Cylinders)	Machine	Aspiration	Fuel Injection System	Bore × Stroke		Displacement	
				mm	in	L	in ³
3003 (3)	301.5	NA	DI	75 × 72	2.95 × 2.83	0.95	58.2
Hatz 2M41L (2)	CB-214C, CB-224C, AP200B	NA	DI	102 × 105	4 × 4.13	1.716	105
3024 (4)	902	NA	DI	84 × 100	3.31 × 3.94	2.22	135
Mitsubishi 4M40E1 (4)	307B*	NA	DI	95 × 100	3.7 × 3.94	2.84	173
3034 (4)	906	NA	DI	97 × 100	3.32 × 3.94	2.95	180
3054 (I-4)	416C, 428C, 307***, CB-434B, CB-544, CB-434C, CB-545, CS-323C, CP-323C, PS-150B, TH62, TH82, TH63	NA	DI	100 × 127	3.94 × 5.0	4.0	243
	(416C), 426C, (428C), 436C, 438C, 312B L***, 315B L***, AP-800C, BG-210B, BG-225C, BG-230, BG-650, 914G, IT14G, PS-200B, PS-360B, PF-300B, PS-300B, CS-431C, CS-433C, CP-433C, CB-534C, CB-534B, CB-535B, (TH62), (TH63), (TH82), TH83, TH103	T (optional)					
	M312, M315, AP-650B	TA					
3064 (I-4)	311B, 312B*	T	DI	105 × 127	4.1 × 5.0	4.40	268
3114 (I-4)	446B, IT24F, 924F	T	DI	105 × 127	4.13 × 5.0	4.4	268
JD4045	BG-240B	T	DI	106 × 127	4.19 × 5.0	4.5	276
3046 (I-6)	D3C Series III, D3C XL Series III, D3C LGP Series III, D4C Series III, 933C, D4C XL Series III, D4C LGP Series III	NA	DI	94 × 120	3.7 × 4.7	5.0	305
	D5C Series III, D5C XL Series III, D5C LGP Series III, 315B/315B L*, 939C, 318B L, 318B LN	T	DI				

DI — Direct Injection
T — Turbocharged

NA — Naturally Aspirated

*Japan sourced.
**Belgium sourced.
***France sourced.

NOTE: Materials and specifications subject to change without notice. Component commonality of Cat Engines for all applications does not imply complete interchangeability. Contact your Caterpillar Dealer for specific information.

Engine Model and (Cylinders)	Machine	Aspiration	Fuel Injection System	Bore × Stroke		Displacement	
				mm	in	L	in ³
3056 (I-6)	BG-730	T	DI	100 × 127	3.94 × 5.0	6.0	365
3066 (I-6)	320B*, 320B L*, 320B N*	T	DI	102 × 130	4.0 × 5.1	6.4	391
3116 (I-6)	M318, M320, 320B**, 320B L**, 320B N**, 320B S**, 613C Series II, 928G, 953C, IT28F, AP-1050B, CS-533C, CS-531C, CS-563C, CS-573C, CS-583C, CB-634C, CP-533C, CP-563C, 322B, 322B L, 322B LN, BG-750, 120H NA, 135H NA, D5M, D6M, 561M	T	DI	105 × 127	4.13 × 5.0	6.6	402
	BG-260C, BG-245C, AP-1055B, 120H NA***, 135H***, 120H STD, 135H STD, 120H ES, 322B/322B LN**, 325B, 325B L, 325B LN, 963B, BG-270B, BG-265B, BG-2455C, AP1000B	TA	DI				
	Challenger 35, Challenger 45	T ATAAC	DI				
3304 (I-4)	D4E SR, 515, 525, 527, 517	T	DI	121 × 152	4.75 × 6	7	425
3126 (I-6)	938G, IT38G	T	DI	110 × 127	4.33 × 5.0	7.2	442
	950G, 962G, IT62G	TA					
	Challenger 55, Lexion 460/465	ATAAC					
3176 (I-6)	Challenger 65E, Challenger 75E, R1700 Series II, R1600, 345B, 345B L, Lexion 480/485	T ATAAC	DI	125 × 140	4.92 × 5.5	10.2	629
3208 (V-8)		NA	DI	114 × 127	4.5 × 5	10.4	636

PC — Precombustion
 DI — Direct Injection
 T — Turbocharged

TA — Turbocharged and Aftercooled
 T ATAAC — Turbocharged and Air/Air Aftercooled
 NA — Naturally Aspirated

*Japan sourced.
 **Belgium sourced.
 ***With VHP option.

NOTE: Materials and specifications subject to change without notice. Component commonality of Cat Engines for all applications does not imply complete interchangeability. Contact your Caterpillar Dealer for specific information.

Tables

Engine Model and (Cylinders)	Machine	Aspiration	Fuel Injection System	Bore × Stroke		Displacement	
				mm	in	L	in ³
3306 (I-6)	D5E, 12H STD	NA	DI	121 × 152	4.75 × 6	10.5	638
	D6R XL, D6R XR, D6R, D6R LGP, D6R WHA, D6G, D6G SR, D7G, 12H NA, 140H NA, 143H NA, 160H NA, 140H STD, 160H STD, 12H ES, 140H ES, 528B, 572R, 627F Sc., 973, 966F Series II	T	DI				
	D7R, D7R XR, D7R LGP, D7R WHA, 637E Series II Sc., R1300, 615C, D25D, 970F, D30D, D250E Series II, D300E Series II, 330B, 330B L, 330B LN, 814F, 815F, 816F, 160H NA***, 163H NA, 160H ES, 14H	TA	DI				
	350, 350 L	T ATAAC	DI				
3196 (I-6)	Challenger 85E, Challenger 95E	T ATAAC	DI	130 × 150	5.1 × 5.9	12	732
3406 (I-6)	980G, PM-465	T	DI	137 × 165	5.4 × 6.5	14.6	893
	621F, 623F, 627F Tr., D350E, D400E, RR-250B, SS-250B, RM-350B, 16H 583R, 824G, 825G, 826G, D8R, D8R LGP, D8R WHA	TA	DI				
	375, 375 L, 5080, R2900	T ATAAC	DI				
3408 (V-8)	D9R, D9R WHA, 589, 631E-II, 633E-II, 637E-II Tr., 657E Sc., 771D, 769D, 834B, 836, 988F-II, PM-565B, AD40, 69D	TA	DI	137 × 152	5.4 × 6	18	1099
		T ATAAC					
3412 (V-12)	D10R, D10R WHA, 651E, 657E Tr., 773D, 775D, 990, 24H, 73D, 844	TA	DI	137 × 152	5.4 × 6	27	1649
3508 (V-8)	D11R, 777D, 776D, 5130B, 992G, 854G	TA	DI	170 × 190	6.7 × 7.5	34.5	2105
3512 (V-12)	785C, 784C	TA	DI	170 × 190	6.7 × 7.5	51.8	3158
3516 (V-16)	789C, 793C, 994, 5230	TA	DI	170 × 190	6.7 × 7.5	69.1	4211

PC — Precombustion
DI — Direct Injection
T — Turbocharged

TA — Turbocharged and Aftercooled
T ATAAC — Turbocharged and Air/Air Aftercooled
NA — Naturally Aspirated

*Japan sourced.
**Belgium sourced.
***With VHP option.

NOTE: Materials and specifications subject to change without notice. Component commonality of Cat Engines for all applications does not imply complete interchangeability. Contact your Caterpillar Dealer for specific information.

	SECTION	page
Abrasiveness ratings (undercarriage)	21	31
Agricultural commodities conversion factors	28	2
Agricultural Equipment	2	1-18
Depreciation and repair costs	21	9
Former Models	20	19
Horsepower ratings	2	11
Altitude:		
Deration table	28	5
Discussion of	23	7
Angle blade (Challenger)	2	16
Angle of repose (materials table)	28	1
Angling “A” blade , description of	1	38
Articulated Dump Trucks	10	1-30
Former models	20	37
Ground Pressure	10	5
Special Arrangements	10	4
Asphalt Pavers	16	11
Attachment (options) selection:		
Backhoe Loaders	5	29
Blades	1	36
Dozers & scoops	1	54
	11	8, 16, 20
	24	40
Excavators	4	146
Grapples	6	5, 13
High speed disc saws	24	40
Hydromechanical work tools	18	1-16
Integrated Toolcarriers	14	4, 13
Land clearing	26	8
Log and lumber forks	24	44
Log loading fronts	24	21
Motor Graders	3	12
Reclaimers/Stabilizers	16	8
Telescopic Material Handlers	15	12
Backhoe Loaders	5	1-30
Digging forces	5	6
Former models	20	30
Ballast:		
Fillage table (Tires)	22	30
Landfill Compactors	11	19
Wheel Tractors	11	6
Barber-Greene:		
Asphalt Pavers	16	14
Road Wideners	16	20
Windrow Elevators	16	21
Bearing powers (materials table)	28	2
Bias ply tires , definition of	22	2
Blades , description of	1	37

	SECTION	page
Brake Performance Curves:		
Construction & Mining Trucks/Tractors	9	10
Use of:		
Construction & Mining Trucks/Tractors	9	8
Bucket capacities:		
Backhoe Loaders	5	20
Excavators	4	102
Definition of	4	91
Ditch cleaning	4	125
Front shovels	4	174
Long reach	4	123
Integrated Toolcarriers	14	5
Telescopic Material Handlers	15	13
Track Loaders	13	4
Underground Mining	17	4
Wheel Loaders	12	6
Bucket fill factors (materials table)	28	1
Excavators	4	120
Front shovels	4	176
Track Loaders	13	17
Wheel Loaders	12	40
Bucket payload:		
Excavators	4	120
Track Loaders	13	17
Wheel Loaders	12	40
Bucket selection:		
Excavators	4	92
Integrated Toolcarriers	14	13
Telescopic Material Handlers	15	13
Underground Mining	17	5
Wheel Loaders	12	45
Bulldozers	1	35
Blade options (summary)	1	36
Blade selection	1	37
Blade Specifications	1	41, 54
	11	8, 16, 20
Correction factors	1	53
Dimension drawing	1	40
SAE Blade Capacity Definition	1	40
Waste disposal	11	20
Cable & ferrule sizes (Winches)	1	78
Coal handling dozers/scoops/buckets	1	55
Production estimating	25	4
Code identification (Tires)	22	4
Cold inflation pressures (Tires)	22	22
Cold Planers	16	1
Applications	16	5
Former models	20	45
Use by project type	16	6

	SECTION	page
Cold planing fundamentals	16	4
Compaction:		
Comparison (Waste Disposal)	27	6
Factors (Waste Disposal)	27	5
Production	27	6
Fundamentals:		
Landfill	11	19
Soil	11	13
Compactors:		
Dual Drum Vibratory Asphalt	16	29
Former Models	20	39, 50
Landfill	11	17
Padded Drum Vibratory Soil	16	26
Pneumatic Tire Asphalt	16	35
Combination Vibratory	16	34
Soil	11	11
Application zones	11	14
Smooth Drum Vibratory Soil	16	22
Concrete Crushers	18	13-14
Applications	18	15
Features	18	15
Matching guide	18	15
Specifications	18	16
Concrete Pulverizers	18	15-16
Applications	18	13
Features	18	13
Matching guide	18	13
Specifications	18	14
Conversion factors, Agricultural Commodities	28	2
Metric-English/English-Metric	28	12
Construction & Mining Trucks/Tractors	9	1-44
Former Models	20	36
Power Train Efficiencies, Mechanical	9	9
Counterweights:		
Stockpile Coal Handling	25	2
Wheel Tractors	11	6
Curl and Crowd Forces:		
Excavators	4	91
Front Shovels	4	173
Curve superelevation table	28	3
Cushion "C" blade, description of	1	38
Cycle times:		
Articulated/Construction & Mining Trucks	9	8
Excavators	4	147
Front Shovels	4	175
Track Loaders	13	16
Wheel Loaders	12	39
Wheel Tractor-Scrapers	8	11, 73

	SECTION	page
Delay time (figuring production)	23	4
Delivered price (O & O)	21	9
Demolition Arrangements (Excavators)	4	127
Demolition Shears	18	10
Depreciation , discussion of (O & O)	21	5
Ditch Cleaning Excavators	4	125
Dozing tools , descriptions of	1	37
Drawbar pull and tillage discussion (Ag Tractors)	2	17
Drawbar pull forward:		
Direct drive:		
Agricultural Tractors	2	13
Track-Type Tractors	1	21
Power shift:		
Pipelayers	7	5
Landfill Compactors	11	18
Soil Compactors	11	12
Track Skidders	6	11
Track-Type Tractors	1	13
Wheel Skidders	6	3
Wheel Tractors	11	4
Dual Drum Vibratory Asphalt Compactors	16	29
Engines	19	1-22
Design data	19	2
Rating explanation	19	2
Used in Caterpillar Products	28	14
English unit equivalents	28	13
Equipment selection:		
Land Clearing	26	2
Stockpile Coal Handling	25	1
Waste Disposal	27	2
Estimating:		
Draft or drawbar pull (Agricultural Tractors)	2	18
Form (O & O)	21	2
Landfill (Waste Disposal)	27	6
Operating Costs (O & O)	21	11
Owning Costs (O & O)	21	5
Tire life	21	27
Undercarriage costs (O & O)	21	31

	SECTION	page
Estimating Production:		
Asphalt Pavers	16	19
Bulldozers	1	49
Cold Planers	16	3
Compactor production (waste disposal)	27	6
Dual Drum Vibratory Asphalt Compactors	16	33
Elements of production	2	17
Excavators	4	150
Front shovels	4	175
Trenching	4	154
Hydraulic hammers	18	8
Land Clearing	26	4
Mining and Earthmoving	23	4
Padded Drum Vibratory Soil Compactors	16	28
Pneumatic Tire Asphalt Compactors	16	37
Ripping	1	68
Production graphs	1	75
Seismic velocity charts	1	69
Road Reclaimer/Soil Stabilizer	16	9
Smooth Drum Vibratory Soil Compactors	16	25
Soil Compactors	11	15
Stockpile Coal Handling	25	3
Tillage	2	17
Towed Scrapers	1	83
Track Loaders	13	16
Trees per acre/hectare	24	51
Skidders	24	1
Waste Disposal	27	6
Wheel Loaders	12	70
Wheel Tractor-Scrapers	8	61
Excavators	4	1-196
Attachment summary	4	140
Curl & crowd forces	4	91
Front shovels	4	173
Demolition arrangements	4	127
Ditch cleaning	4	125
Former models	20	24
Front shovels	4	161
Long reach	4	123
Major component weights	4	29
Long reach	4	124
Material handling arrangements	4	182
Shoe selection	4	137
Front shovels	4	173
Stick/bucket combinations	4	135
Quick Coupler	4	140

	SECTION	page
Fill factor (discussion of)	23	3
Filters (O & O).	21	20
Fire Pump Engines	19	7
Fixed times (hauling units)		
Articulated Trucks	9	8
Construction & Mining Trucks.	9	8
Wheel Tractor-Scrapers	8	11
Forestry Machines	24	18
Formulas & rules of thumb (Earthmoving)	23	15
Front Shovels (Excavators).	4	161
Fuel consumption:		
Machine productivity	23	14
Tables (O & O).	21	12
Generator Sets:		
Diesel	19	10
Gaseous Fueled	19	13
Marine	19	18
Olympian	19	12
Goodyear:		
Tire life (estimating system).	21	30
Grade:		
Comparison chart/degrees & percent.	28	11
Resistance (discussion of).	23	6
Grapples	6	6, 13
SAE definition	6	5
Ground pressures:		
Articulated Trucks	10	5
Excavators.	4	137
Front shovels	4	173
Track Loaders (LGP).	13	2
Track-Type Tractors	1	23
Heel Boom Grapples	24	39
High speed disc saws	24	40
Hydraulic controls	1	31
Hydraulic hammers	18	1-8
Applications.	18	2
Features.	18	1
Production tables	18	8
Selection guide	18	7
Specifications.	18	3
Hydromechanical Work Tools	18	1-16
Hydraulic Hammers	18	1
Concrete Crushers	18	15
Concrete Pulverizers.	18	13
Mobile Shears	18	10

	SECTION	page
Impact Ratings (undercarriage)	21	31
Industrial Engines:		
Diesel	19	3
Gaseous Fueled	19	8
Index	29	1-18
Integrated Toolcarriers	14	1-20
Former models	20	44
Tools (attachments)	14	4
Interest, Insurance & Taxes (O & O)	21	10
Introduction		1-3
Job:		
Efficiency/layout (estimating production)	23	8
Survey (Land Clearing)	26	2
“K/G” blade , description of	1	39
Production factors	26	5
Land Clearing	26	1-8
Clearing methods & equipment	26	2
Variables affecting operations	26	1
Landfill:		
Blades	1	54
Description of	11	20
Description of	1	39
Compactors	11	17
Estimating (Waste Disposal)	27	6
Equipment selection	27	2
Methods (Waste Disposal)	27	1
Production estimating	27	6
Refuse densities	27	4
Lifting capacity:		
Backhoe Loaders	5	21
Excavators	4	58
Material handling arrangements	4	182
Log Loaders	24	21
Pipelayers	7	3
Telescopic Material Handlers	15	3
Liquid ballasting (Tires)	22	30
Loading/hauling systems	23	13
Load factor (discussion of)	23	2
Load weighing (figuring production)	23	4

	SECTION	page
Log:		
Comparison of log rules	24	51
Forestry machines	24	18
Loaders	24	7
Loading forks	24	7
Lumber forks	24	44
Rule of thumb conversions	24	52
Skidding resistance table	24	3
Stroke Delimber	24	41
Volume tables	24	46
Logging and Forest Products	24	1-52
Former models	20	29
Units of measurement	24	52
Long Reach Excavators	4	123
Lube oils and grease fittings (O & O)	21	20
Machine dimensions:		
Backhoe Loaders	5	28
Excavators	4	16
Demolition Arrangements	4	127
Ditch cleaning	4	125
Front shovels	4	172
Long reach	4	123
Integrated Toolcarriers	14	9
Track Loaders	13	12
Wheel Loaders	12	31
Track-Type Tractors	1	3
Machine selection:		
Cold Planers	16	4
Excavators	4	134
Integrated Toolcarriers	14	14
Land Clearing	26	2
Stockpile Coal Handling	25	1
Track Loaders	13	15
Waste Disposal	27	2
Wheel Loaders	12	39
Wheel Tractors	11	6
Marine Auxiliary Engines	19	19
Marine Generator Sets	19	18
Marine Propulsion Engines, rating levels	19	15
Material density (discussion of)	23	2
Material handling arrangements:		
Excavators	4	182
Integrated Toolcarriers	14	8, 11, 16
Metric unit equivalents	28	13

	SECTION	page
Mining and Earthmoving	23	1-16
Elements of production	23	1
Systems	23	13
Loading match	23	14
Formulas and rules of thumb	23	15
Mobile Shears	18	10-12
Applications	18	10
Capability tables	18	10
Features	18	10
Matching Guide	18	12
Specifications	18	11
Motor Graders	3	1-12
Former models	20	22
Front mounted scarifiers	3	10
Rippers/Scarifiers	3	11
Nomenclature		8-14
Nomographs:		
Land Clearing	26	4
Track Loaders	13	19
Trenching (Excavators)	4	156
Wheel Loaders	12	43
Operator and machine protection		5
Owning & Operating Costs (O & O)	21	1-52
Agricultural tractor depreciation and repair	21	9
Estimating form	21	2
Example I: Track-Type Tractor	21	42
Example II: Wheel Loader	21	44
O & O form with example figures	21	45
Operator's hourly wage	21	42
Ownership period guide	21	6
Residual value at replacement	21	9
Special wear items	21	42
Value recovered through work	21	10
Padded Drum Vibratory Soil Compactors	16	26
Pallet forks	14	7, 10, 17
Parts replacement warning		7
Paving Products	16	1-44
Former models	20	45
Performance data:		
Backhoe Loaders	5	5
Integrated Toolcarriers	14	5
Telescopic Material Handlers	15	3
Track Loaders	13	4
Wheel Loaders	12	6
Winches	1	81

	SECTION	page
Pipelayers	7	1-6
Former models.	20	30
Hook speeds.	7	6
Pneumatic Tire Asphalt Compactors	16	35
Power Angling & Tilt blade, description of	1	38
Power unit equivalents	28	13
Preface		4
Production estimating; see estimating production		
Quick estimators (O & O)	21	48
Radial ply tires, definition of	22	3
Rake blades, description of	1	39
Rakes (Land Clearing)	26	8
Range dimensions (diagrams):		
Backhoe Loaders	5	6
Excavators	4	34
Demolition Arrangements.	4	128
Ditch cleaning	4	125
Front shovels	4	168
Long reach	4	123
Material handling arrangements	4	182
Log Loaders	24	21
Telescopic Material Handlers	15	3
Reclaimers/Stabilizer Mixers	16	7
Refuse densities	27	4
Repair reserve (O & O)	21	33
Retarder Curves:		
Articulated Dump Trucks	10	9
Use of.	8	11
Wheel Tractor-Scrapers	8	20
Rimpull-speed-gradeability curves:		
Articulated Dump Trucks	10	8
Construction & Mining Trucks/Tractors	9	10
Landfill Compactors	11	18
Soil Compactors.	11	12
Track Skidders	6	11
Wheel Skidders	6	3
Use of.	8	8
Wheel Tractor-Scrapers	8	13
Wheel Tractors	11	4
Rippers/Scarifiers	1	57
	3	11
	13	14
Dimension drawings	1	58
Forces, definition of.	1	58
Tip selection.	1	67

	SECTION	page
Rolling resistance:		
Discussion of (estimating production)	23	5
Factors table	28	1
Rome blades	1	39
	26	8
SAE (Society of Automotive Engineers) Guidelines:		
Breakout Force		
Loaders, Track and Wheel	12	37
Bucket Capacity		
Excavators	4	91
Track Loaders	13	15
Wheel Loaders	12	39
Bulldozer Blade Capacity	1	40
Curl and Crowd Forces:		
Excavators	4	91
Front Shovels	4	173
Tipping Conditions:		
Excavators	4	58
Loaders, Track and Wheel	12	38
Saw, high speed disc	24	40
Scarifiers	3	10
Seismic velocity charts (rippers)	1	69
Semi-Universal “SU” blade:		
Description of	1	37
Production estimating chart	1	51
Shipping dimensions , see machine dimensions		
Skidders (Track & Wheel)	6	1-14
Former models	20	29
Smooth Drum Vibratory Soil Compactors	16	22
Soil Compactors	11	11-16
Types & application zones	11	14
Soil density testing	23	3
Specifications:		
Agricultural Tractors	2	6
Articulated Dump Trucks	10	2
Asphalt Pavers	16	11
Backhoe Loaders	5	2
Bulldozers:		
Challenger Tractors	2	13
Landfill Compactors	11	20
Soil Compactors	11	16
Track-Type Tractors	1	41, 54
Waste Disposal Track-Type Tractors	1	25
Wheel Tractors	11	8
Cold Planers	16	2

	SECTION	page
Compactors:		
Dual Drum Vibratory Asphalt	16	29
Landfill	11	18
Padded Drum Vibratory Soil	16	26
Pneumatic Tire Asphalt	16	35
Combination Vibratory Asphalt	16	34
Soil	11	12
Smooth Drum Vibratory Soil	16	22
Concrete Crushers	18	16
Concrete Pulverizers	18	14
Construction & Mining Tractors	9	6
Construction & Mining Trucks	9	2
Engines:		
Generator Sets	19	10
Industrial	19	3
Marine Generator Sets	19	18
Marine Propulsion	19	15
Truck	19	20
Excavators	4	2
Front Shovels	4	162
Hydraulic Controls	1	32
Hydraulic Hammers	18	4
Integrated Toolcarriers	14	2
Lexion Combines	2	9
Mobile Shears	18	11
Motor Graders:		
ES Versions	3	9
NA Versions	3	6
Global Versions	3	8
Standard Versions	3	4
Pipelayers	7	2
Rippers, Ripper/Scarifiers:		
Motor Graders	3	10
Track Loaders	13	84
Track-Type Tractors	1	61
Reclaimers/Stabilizers	16	8
Super Rural Tractors	2	10
Telescopic Material Handlers	15	1
Track Skidders	6	10
Track Loaders	13	2
Track-Type Tractors	1	3
Underground Mining, LHD	17	2
Trucks	17	4
Versatile Flotation System Trailers (VFS)	2	8
Waste Handling:		
Compactors	11	18
Track Loaders (WHA)	13	25
Track-Type Tractors (WHA)	1	26
Wheel Loaders (WHA)	12	76
Wheel Loaders	12	2

	SECTION	page
Wheel Skidders	6	2
Wheel Tractor-Scrapers:		
Auger scrapers	8	5
Elevating scrapers	8	4
Standard scrapers	8	2
Tandem powered & Push-Pull	8	3
Wheel Tractors	11	12
Winches	1	78
Windrow Elevators	16	21
Speed conversion table	28	2
Stabilizer/Mixers	16	7
Stockpile Coal Handling	25	1-10
Straight “S” blade:		
Description of	1	38
Production estimating chart.	1	52
Swell (discussion of)	23	2
Swell-voids-load factors table	28	1
Tables	28	1-18
Telescopic Material Handlers.	15	1-14
Attachments	15	12
Dimensions	15	11
Performance data	15	3
Specifications.	15	1
Tire Selection.	15	11
Temperature conversion	28	12
Time studies (figuring production)	23	4
Tire & Rim Association ratings	22	21
Tires	22	1-30
Code identification	22	4
Cold inflation pressures	22	22
Construction (bias & radial ply)	22	2
ISO load index speed symbol	22	20
Life estimator curves (O & O)	21	27
Goodyear life estimating system	21	30
Liquid Ballasting	22	30
	11	6
Manufactures designation	22	5
Radial tire identification.	22	7
Selection & maintenance:		
Discussion of application/guide	22	1, 21
Wheel Tractors.	11	6
Size nomenclature.	22	3
Specifications:		
Construction & Mining Trucks/Tractors	9	7
Wheel Tractor-Scrapers.	8	7
Ton-miles per hour:		
Charts.	22	10
Method of rating/definitions	22	8
Types — Load & carry/Transport/Work	22	3

	SECTION	page
Total resistance (estimating production)	23	6
Towed Scrapers	1	83
Former models.	20	35
Track Loaders	13	1-28
Former models.	20	42
Rippers/Scarifiers	13	14
SAE ratings (discussion of).	13	15
Waste Handling	13	25
Track spacing guide (Challenger tractors)	2	15
Track Skidders	6	9
Track-Type Tractors	1	1-24
Blade selection	1	37
Extreme slope operation.	1	24
Former models.	20	1
Traction (estimating production)	23	6
Coefficient factors:		
Coal stockpile (table).	25	3
Materials table	28	2
Travel speeds — direct drive:		
Agricultural Tractors	2	12
Track-Type Tractors	1	21
Travel speeds — power shift:		
Landfill Compactors	11	18
Motor Graders	3	10
Pipelayers	7	6
Soil Compactors.	11	12
Track Skidders	6	11
Track-Type Tractors	1	20
Wheel Skidders	6	3
Wheel Tractors	11	4
Travel time charts:		
Articulated Dump Trucks	10	10
Construction & Mining Trucks/Tractors	9	13
Track Loaders	13	21
Use of.	8	10
Wheel Loaders.	12	49
Wheel Tractor-Scrapers	8	14
Tree cutters & pushers	26	8
Trees per acre/hectare (estimating production)	24	51
Truck Engines	19	20
Two-Way dozer (description)	1	39

	SECTION	page
Undercarriage (basic factors & condition multipliers)	21	31
Underground Mining (Elphinstone)	17	1-10
Bucket capacities	17	4
Dimensions & capacities (LHD)	17	4
Trucks	17	6
Former Models	20	52
Loading/hauling systems	17	9
Specifications, LHD	17	2
Trucks	17	6
Unit equivalents — English, Metric, Power	28	13
Universal “U” blade:		
Coal dozer (production estimating chart)	25	4
Description of	1	37
Earthmoving (production estimating chart)	1	50
V-Tree Cutter blade , description of	1	39
Variable radius “VR” blade (description of)	1	38
Capacities	1	54
Versatile Flotation System (description of)	2	4
Vital Information Management System (VIMS)	4	174
Volume Measure (discussion of)	23	2
W-Landfill blade	11	20
Wait time (figuring production)	23	4
Waste Disposal/Handling	27	1-8
Compactors (Landfill)	11	17
Refuse densities	27	4
Track Loaders	13	25
Track-Type Tractors	1	25
Wheel Loaders	12	75
Weights:		
Commercially important wood	24	48
Materials	28	4
Stabilization/reclamation	16	10
Round reinforced concrete pipe	28	2
Wheel Loaders	12	1-78
Former models	20	40
SAE ratings, discussion of	12	37
Waste Handling	12	75
Wheel Skidders	6	1-8

	SECTION	page
Wheel Tractor-Scrapers	8	1-74
Former models.	20	32
Push loading times (fixed), typical.	8	11
Wheel Tractors	11	1-10
Former models.	20	39
Winches	1	77
Windrow Elevators	16	21
Woodchip dozers and scoops	1	55
	11	9
	24	40
“Z” factor (undercarriage)	21	31