



Review in Advance first posted online
on January 14, 2009. (Minor changes may
still occur before final publication
online and in print.)

Feedbacks, Timescales, and Seeing Red

Gerard Roe

Department of Earth and Space Sciences, University of Washington, Seattle, Washington 98195

Annu. Rev. Earth Planet. Sci. 2009. 37:5.1–5.23

The *Annual Review of Earth and Planetary Sciences* is
online at earth.annualreviews.org

This article's doi:
[10.1146/annurev.earth.061008.134734](https://doi.org/10.1146/annurev.earth.061008.134734)

Copyright © 2009 by Annual Reviews.
All rights reserved

0084-6597/09/0530-0001\$20.00

Key Words

Earth systems dynamics, response times, red noise

Abstract

Feedback analysis is a powerful tool for studying the Earth system. It provides a formal framework for evaluating the relative importance of different interactions in a dynamical system. As such, its application is essential for a predictive or even a mechanistic understanding of the complex interplay of processes on the Earth. This paper reviews the basic principles of feedback analysis and tries to highlight the importance of the technique for the interpretation of physical systems. The need for clear and consistent definitions when comparing different interactions is emphasized. It is also demonstrated that feedback analyses can shed light on how uncertainty in physical processes translates into uncertainty in system response, and that the strength of the feedbacks have a very tight connection to the dynamical response time of the system.

INTRODUCTION

The language of feedbacks is ubiquitous in contemporary Earth sciences. The very notions of Earth systems science and Earth system models embody at their core the concepts and principles of systems dynamics, for which feedback analysis is one of the theoretical cornerstones. The identification and evaluation of positive and negative feedback mechanisms in the Earth system has come to be seen as a major research goal.

In tackling the challenge of understanding an Earth system in which everything influences everything else, feedback analysis provides a formal framework for the quantification of coupled interactions. Such systematic characterization is essential if the knotted skein of interdependent processes is to be teased apart and understood. Our confidence in the predictions we make of future states of the system rests on our confidence that the interactions between the constituent elements have been properly defined, and their uncertainties characterized. Feedback analysis not only provides information about the magnitude of the system's response to a perturbation, it also supplies a rich picture of the system dynamics. For example, the relative importance of different feedbacks identifies the pathways by which a system adjusts when perturbed. Yet despite its central importance to the interpretation of system dynamics, formal feedback analysis is almost absent in Earth sciences and quite rare even in climate dynamics, where its use is most prevalent.

The history of the recognition of feedbacks is perhaps best described as an emerging awareness. Adam Smith, for instance, had a clear understanding of the feedbacks inherent in the operation of the invisible hand—the set of natural and mutual interactions that govern commerce (Smith 1776). In practical applications, the use of feedback principles to regulate mechanical devices goes back much further. Centrifugal governors, which act to automatically maintain the distance between the bed and runner stones, have been employed in wind- and water mills since the seventeenth century (e.g., Maxwell 1867), and float valves were used by the Greeks and Romans in water clocks. However, the abstract idea of a feedback was first conceived of and formalized by Harold S. Black in 1927. Black was searching for a way to isolate and cancel distortion in telephone relay systems. He describes a sudden flash of inspiration while on his commute into Manhattan on the Lackawanna Ferry. The original copy of the page of the *New York Times* on which he scribbled down the details of his brain wave a few days later still has pride of place at the Bell Labs museum, where it is regarded with great reverence (**Figure 1**). Some of the concepts and consequences of feedbacks are counterintuitive, so much so that it took Black more than nine years to get his patent granted—the U.K. patent office would not countenance it until a fully working model was delivered to them. Only after being convinced that seventy negative-feedback amplifiers were already in operational use were they finally persuaded to issue a patent. Black (1977) writes that “Our patent application was treated in the same manner one would a perpetual motion machine.” Since the initial skepticism, the principles of feedback analysis have become widely disseminated in the fields of electrical engineering and control systems. For the latter, in fact, they are the foundational theory.

The notion that internal, mutually interacting processes in nature may act to amplify or damp the response to a forcing goes back at least as far as Croll (1864), who invoked the interaction between temperature, reflectivity, and ice cover in his theory of the ice ages. Arrhenius (1896), in his original estimate of the temperature response to a doubling of carbon dioxide, takes careful and quantitative account of the water vapor feedback that amplifies the response to the radiative forcing. The explicit mention of feedbacks seems to enter the Earth sciences via the climate literature starting in the mid 1960s (e.g., Manabe & Wetherald 1967, Schneider 1972, Cess 1975), and in the popular imagination through the concept of Gaia (Lovelock & Margulis 1974). At first, it appears mainly as a conceptual description of physical processes relating to climate sensitivity.

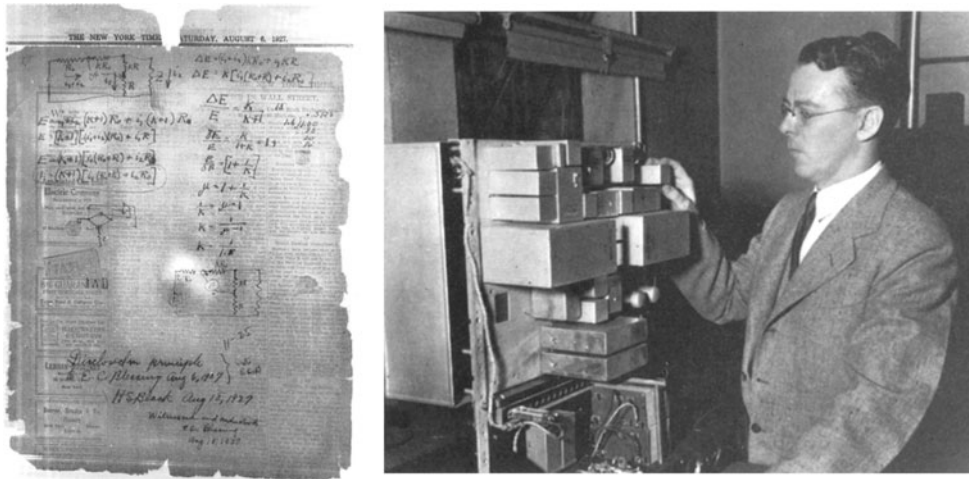

Figure 1

Harold S. Black (1898–1983), inventor of the concept of a negative feedback, and the page of the August 6, 1927 copy of the New York Times on which he scribbled a basic outline of his ideas while commuting into Manhattan on the Lackawanna Ferry. Reproduced with permission from Kline (1993) and from the AT&T Archives.

Hansen et al. (1984) and Schlesinger (1985) contributed groundbreaking papers, making quantitative comparisons of different feedbacks in a climate model (but see footnote 4). Since then, there has been a thin but steady stream of studies quantifying climate system feedbacks (e.g., Manabe and Wetherald 1988, Schlesinger 1988, Cess et al. 1990, Zhang et al. 1994, Colman et al. 1997, Colman 2003, Soden & Held 2006).

This purpose of this article is a pedagogic review of the basic principles of feedback analysis. The reasons for this are twofold. First, despite its central importance in Earth systems dynamics, the quantitative analysis of feedbacks is rarely presented in textbooks or even applied in practice. In its most common application, climate dynamics, the literature is confusing and, in some places, flat out contradictory (compare, for instance, Hansen et al. 1984, NRC 2003, Bony et al. 2006, and Torn & Harte 2006 with Schlesinger 1985, Peixoto & Oort 1992, Lindzen 1994, and Wallace & Hobbs 2006; see also footnote 4). Second, although there is a widespread qualitative understanding of feedbacks, there are some useful lessons and subtleties that come from the quantitative analysis, which are not as widely appreciated as they might be. Such aspects of feedbacks have important consequences for the interpretation of climate time series and geophysical data in general. These properties are drawn out and highlighted in this review.

Feedbacks are discussed here mainly in the context of the climate system, which is used as a vehicle for presenting the framework. The extension to other physical systems is direct (e.g., Roe et al. 2008), and in order to keep this extension as clear as possible, many important details of climate feedbacks are not dwelt on. Several excellent studies that do discuss them are cited herein. There is nothing substantially new in what is presented here—material is drawn together from different sources and combined in an effort to provide a coherent framework. It is hoped that there is value in laying out the framework clearly; in emphasizing the fundamental relationships that exist between feedbacks, system response, uncertainty in physical processes, and the timescale of the system response; and in highlighting a few of the many examples where the principles can be seen operating in practice.

BASICS OF FEEDBACK ANALYSIS

We develop the framework of feedback analysis in the context of a simple, global- and annual-mean climate model following, for example, Trenberth (1992) and Wallace & Hobbs (2006). Let R be the radiation imbalance at the top of the atmosphere between the net longwave radiation flux, F , and the net shortwave radiation flux, S . In equilibrium, $R = S + F = 0$.¹ Let T be the global- and annual-mean temperature that characterizes this equilibrium state.

Now let ΔR_f be a sustained perturbation (i.e., a forcing) to this energy balance such that in the new equilibrium state it produces a climate change ΔT . The climate sensitivity parameter,² λ , is defined as the constant of proportionality that relates the two,

$$\lambda \equiv \frac{\Delta T}{\Delta R_f}. \quad (1)$$

λ is the temperature change per unit of radiative forcing, with units of $\text{K} (\text{W m}^{-2})^{-1}$.

In order to quantify the effect of a feedback, a reference system (i.e., a system without the feedback) must be defined. Defining this reference system is a central aspect of feedback analysis. In the case of the climate system, the idealization of a blackbody planet is generally used. In the absence of an atmosphere, S is a constant that depends on the albedo and the solar constant, and F is governed by the Stefan-Boltzman equation: $F = -\sigma T^4$ (the minus sign indicating outgoing flux). In response to the applied forcing, the atmosphere radiation balance adjusts such that $\Delta R = -\Delta R_f$. Hence, the reference-system climate sensitivity parameter, λ_0 , can be found from

$$\Delta R = -\Delta R_f = \left(\frac{dS}{dT} + \frac{dF}{dT} \right) \Delta T, \quad (2)$$

and thus

$$\lambda_0 = \frac{\Delta T}{\Delta R_f} = -\frac{1}{dF/dT} = \frac{1}{4\sigma T^3}. \quad (3)$$

For an equilibrium temperature of 255 K, $\lambda_0 = 0.26 \text{ K} (\text{W m}^{-2})^{-1}$. In practice, the finite absorptivity of the atmosphere in the longwave band means that, in global climate models, the reference climate sensitivity parameter, determined after removing all dynamic feedbacks, is 0.31 to 0.32 $\text{K} (\text{W m}^{-2})^{-1}$ (e.g., Hansen et al. 1984, Colman 2003, Soden & Held 2006). For the 4 W m^{-2} radiative perturbation that a doubling of carbon dioxide produces, the reference-system climate sensitivity³ is $\Delta T_0 = \lambda_0 \Delta R_f \sim 1.2$ to 1.3°C . In general terms, the reference system takes a perturbation in the forcing, ΔR_f , and converts it into a response, ΔT_0 (**Figure 2a**).

The broadest definition of a feedback is a process that, when included in the system, makes the forcing a function of the response; in other words, some fraction of the output is fed back into the input (**Figure 2b**). The major feedbacks in the climate system are well known: For example, a positive radiative forcing such as that due to an increase in CO_2 tends to increase temperatures, which tends to increase water vapor, which, in turn, produces a perturbation in the downwelling longwave radiation that amplifies the original forcing. Other important feedbacks involve cloud radiative forcing, albedo, and the lapse rate (e.g., Colman 2003, Soden & Held 2006).

When a feedback process is included in the system, the radiative perturbation to the system gets an additional nudge (either positive or negative) that is a function of the system response. The

¹A sign convention is made here: Downward-directed fluxes are positive, consistent with a warming tendency. Outgoing fluxes are negative.

²Sometimes λ is known simply as the climate sensitivity, but see the following footnote.

³In the terminology of the IPCC, climate sensitivity is strictly defined as the equilibrium response of the annual- and global-mean surface air temperature to a doubling of carbon dioxide.

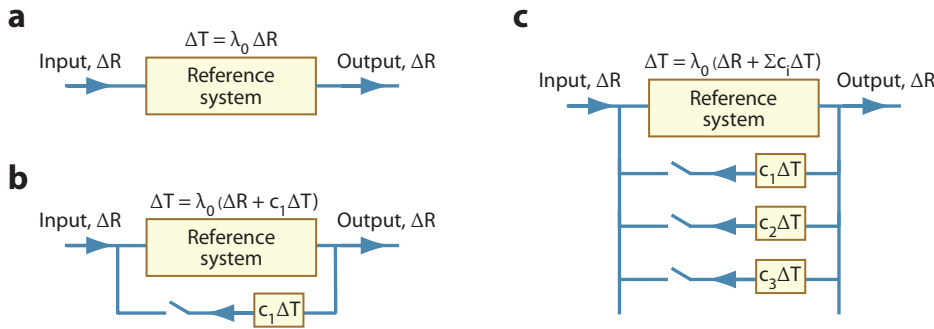

Figure 2

Schematic illustration of an idealized dynamic system: (a) Reference system only, (b) one feedback, and (c) multiple feedbacks. The feedback loops take some fraction of the system output and feed it back into the system input.

simplest representation is that this radiative nudge is linearly proportional to the system response, $c_1 \Delta T$, where c_1 is a constant. With the addition of $c_1 \Delta T$ to the radiative perturbation, the equation that governs the new equilibrium response is

$$\Delta T = \lambda_0 (\Delta R_f + c_1 \Delta T). \tag{4}$$

A point of emphasis from Equation 4 is that the climate sensitivity parameter, λ_0 , (or its equivalent in other systems) is unchanged by the inclusion of a feedback. What changes is the radiative perturbation to the system.

Solving for ΔT ,

$$\Delta T = \frac{\lambda_0 \Delta R_f}{1 - c_1 \lambda_0}. \tag{5}$$

At this point, it is helpful to introduce some terminology to characterize the effect of the feedback. The system gain, G , is the factor by which the system response has gained due to the inclusion of the feedback, compared with the reference-system response,

$$G = \frac{\Delta T}{\Delta T_0}. \tag{6}$$

The feedback factor, f , is proportional to the fraction of the system output fed back into the input,

$$f = c_1 \lambda_0. \tag{7}$$

In the electrical-engineering literature and the control-systems literature, both c_1 and $c_1 \lambda_0$ are referred to as the feedback factor (e.g., Bode 1945, Graeme 1996, Kories & Schmidt-Waller 2003). The above choice is preferred as a nondimensional measure of the feedback. However, it should be borne in mind that, in so choosing, the feedback factor becomes dependent on the reference-system sensitivity parameter.⁴

Combining Equations 5, 6, and 7, it can be shown that

$$G = \frac{\Delta T}{\Delta T_0} = \frac{1}{1 - f}. \tag{8}$$

⁴Hansen et al. (1984) reverses the conventional definition of a feedback factor and a gain, but is thereafter consistent.



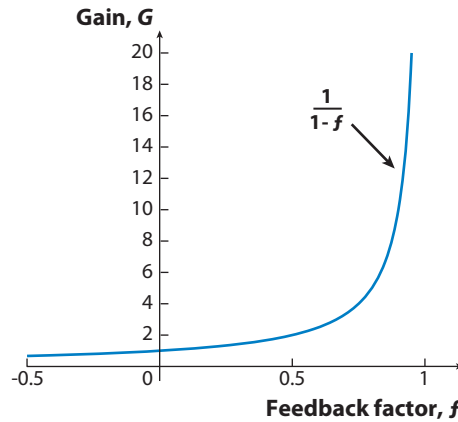

Figure 3

The gain curve, showing how the gain, G , varies as a function of the feedback factor, f : $G = 1/(1 - f)$. The high curvature of the line as $f \rightarrow 1$ produces large increases in G for small increases in f .

The curve of Equation 8 is shown in **Figure 3**. For $-\infty < f < 0$, $G < 1$; thus, the inclusion of the feedback has damped the system response (i.e., $\Delta T < \Delta T_0$), and it is therefore termed a negative feedback. For $0 < f < 1$, $G > 1$; thus, the inclusion of a feedback has amplified the system response, and it is therefore termed a positive feedback. The $1/(1 - f)$ behavior of the gain is extremely important and has crucial implications for dynamical systems—for instance, there is a high degree of asymmetry between positive and negative feedbacks, which is a simple and direct consequence of Equation 4.

For $f \geq 1$, G is undefined. In setting up Equation 2, it was implicitly assumed that a new equilibrium was possible, but this is not necessarily so. As the fraction of the output fed back into the input exceeds $1/\lambda_0$, the basic equilibrating tendency of the reference system can no longer keep up with the amplification from the feedback process, and catastrophic runaway growth ensues. In real systems, this cannot continue indefinitely. Eventually, some other physical process must arise to produce a new equilibrium. The model system represented by Equation 2 has broken down because that other physical process has not been included. Note also that the not-uncommon misconception that a positive feedback automatically implies a runaway feedback is not true.

ASPECTS OF FEEDBACKS ANALYSIS

Feedbacks Combine in Odd Ways

Any number of feedbacks can be incorporated (**Figure 2c**). For a system of N feedbacks, Equation 4 becomes

$$\Delta T = \lambda_0(\Delta R_f + c_1\Delta T + c_2\Delta T + c_2\Delta T + \dots + c_N\Delta T). \tag{9}$$

Hence,

$$\Delta T = \frac{\lambda_0\Delta R_f}{1 - \lambda_0 \sum_i c_i}, \tag{10}$$

and so the gain and feedback factors are now given by

$$G = \frac{1}{1 - \sum_i f_i}, \tag{11}$$



where

$$f_i = \lambda_0 c_i. \quad (12)$$

A key point relating to Equation 11 is that individual feedback factors combine linearly, whereas individual gains do not.⁵ As a demonstration of this, consider the following examples of how two feedbacks combine.

Example 1: Consider one feedback with a gain $G_1 = 1.5$ (i.e., a 50% amplification) and a second feedback with a gain $G_2 = 2.0$ (i.e., a 100% amplification). If gains combined additively, the total amplification would give 50% (i.e., $G_1 - 1$) plus 100% (i.e., $G_2 - 1$), plus the original 100%; in other words, the system response would be amplified to 250% of its original (i.e., no feedback) response. In fact, in Equation 8, the two feedback factors are $f_1 = 1/3$ and $f_2 = 1/2$. Thus from Equation 11, the combined feedbacks produce a total system gain of $G = 1/(1 - 1/3 - 1/2)$, or 600% of the original response—more than twice what one might expect. This occurs because of the compounding effect that positive feedbacks have on each other; the amplitude of the additional radiative perturbation that one feedback produces (i.e., $c_{1,2} \Delta T$) is amplified by the enhanced system response (i.e., ΔT) the other has created, making the total system response that much larger still.

Example 2: Consider two cases where two feedbacks might apparently cancel one another out. In the first case, let one feedback cause a 20% amplification, and the other cause a 20% damping, of the system response (i.e., $G_1 = 1.2$, $G_2 = 0.8$). By Equation 8, $f_1 = 0.17$ and $f_2 = -0.25$, thus Equation 11 indicates the total gain $G = 0.93$. The net effect on the system response is indeed quite close to canceling out. In the second case, let one feedback cause an 80% amplification and the other an 80% damping ($G_1 = 1.8$, $G_2 = 0.2$). By Equation 8, $f_1 = 0.44$ and $f_2 = -4.0$. Now Equation 11 gives a total system gain of only $G = 0.22$; in other words, the combined effect is a strong damping of the system response. The reason for this somewhat counterintuitive behavior is the strong asymmetry between large positive and negative feedbacks, evident graphically in **Figure 3**.

Feedbacks are Just Taylor Series in Disguise

Although the analysis is presented here in the context of our simple climate model, the analogy to other general systems of feedbacks is straightforward. In our climate model, the reference system was constructed by imagining that only the surface temperature was allowed to adjust to a radiative forcing. All other climate fields such as clouds, water vapor, and albedo were decreed fixed. Let α_i stand for the i th such climate field.

A Taylor series expansion can be written that describes how the radiative adjustment of the system depends on how these α_i fields vary with changing climate:

$$\Delta R_\alpha = \frac{dR_\alpha}{dT} \Delta T + O(\Delta T^2) = \left\{ \sum_{i=1}^N \left[\left(\frac{\partial R}{\partial \alpha_i} \right)_{\alpha_{j,j \neq i}} \frac{d\alpha_i}{dT} \right] \right\} \Delta T + O(\Delta T^2). \quad (13)$$

Therefore, the equivalent of Equation 9 is

$$\Delta T = \lambda_0 (\Delta R_f + \Delta R_\alpha) = \lambda_0 \left\{ \Delta R_f + \sum_{i=1}^N \left[\left(\frac{\partial R}{\partial \alpha_i} \right)_{\alpha_{j,j \neq i}} \frac{d\alpha_i}{dT} \right] \Delta T \right\}, \quad (14)$$

⁵Because of the conflicting definitions, this statement is sometimes reversed in the literature.

where second-order terms and higher are neglected. When the ΔT s are gathered, the equation can be rewritten as

$$\Delta T = \frac{\lambda_0}{(1 - \sum_i f_i)} \Delta R_f, \quad (15)$$

where

$$f_i = \lambda_0 \left\{ \frac{\partial R}{\partial \alpha_i} \right\}_{\alpha_{j,j \neq i}} \frac{d\alpha_i}{dT}. \quad (16)$$

The importance of the reference system. Sometimes only a small set of climate variables, $\{\alpha_k\}$, are of interest. For example, one might want to compare the effect of soil moisture changes versus vegetation changes in a climate-change scenario. In such modeling experiments, variables other than the α_k s may be allowed to vary freely in numerical integrations of the model. In this instance then, the reference system becomes all parts of the system that are allowed to vary, and the feedbacks are the specific processes of interest. Partitioned in this way, the appropriate climate sensitivity parameter for the reference system is given by

$$\lambda_0 = \frac{1}{(\partial R / \partial T)_{k,vk}}, \quad (17)$$

and the full system response is

$$\Delta T = \lambda_0 \left\{ \Delta R_f + \sum_{k=1}^{N_k} \left[\frac{\partial R}{\partial \alpha_k} \right]_{\alpha_{j,j \neq k}} \frac{d\alpha_k}{dT} \right\} \Delta T. \quad (18)$$

Thus λ_0 and the f_k s depend on which processes are included in the reference system and which processes are considered feedbacks (i.e., the α_k s). Gains and feedbacks calculated with respect to different reference systems cannot be directly compared.

Calculating feedbacks in climate models. This section briefly explains one method for calculating feedback factors associated with changes in individual climate fields. Much more detail can be found in Wetherald & Manabe (1988), Colman (2003), Bony et al. (2006), Soden & Held (2006), and references therein. The discrete approximation to Equation 16 is

$$f_i \approx \lambda_0 \left\{ \frac{\Delta R}{\Delta \alpha_i} \right\}_{\alpha_{j,j \neq i}} \frac{\Delta \alpha_i}{\Delta T}. \quad (19)$$

The Δ s represent the difference between two equilibrium climate model states; typically, these would be preindustrial and $2 \times \text{CO}_2$ climates. For a given feedback involving a particular climate field α_i , the second term within the braces can be calculated directly from the differences between the two equilibrium states (calculated point-wise and then averaged seasonally and globally). The first term within the braces is the change in the top-of-atmosphere radiation balance for a change in α_i , all other fields being held fixed. This can be determined from off-line calculations by driving the climate model's radiation code using the climate fields, α_j , $j \neq i$, from one of the equilibrium climate states, except for the α_i field, for which values from the other equilibrium state is used. Computing the resulting changes in R allows $(\Delta R / \Delta \alpha_i)_{\alpha_{j,j \neq i}}$ to be determined. **Figure 4** shows results from two studies looking at feedback factors in two different suites of global climate models (Colman 2003, Soden & Held 2006). The water vapor and lapse rate feedbacks are typically combined because there is a strong negative correlation between the two. The largest scatter in feedback strength is found for the cloud feedback.

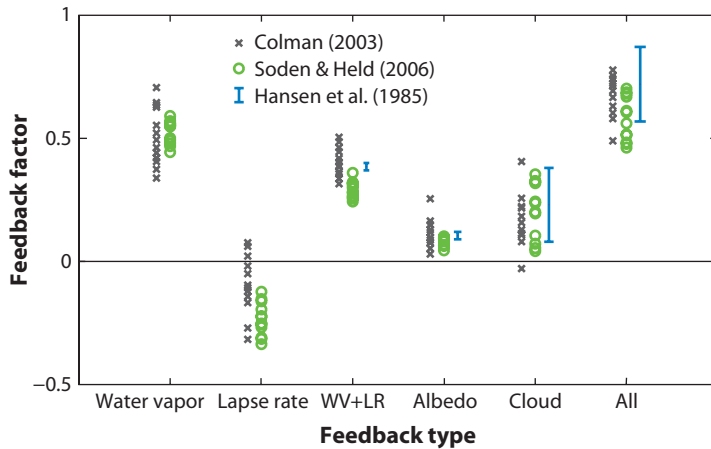

Figure 4

Sample feedback factors determined from two studies using suites of global climate models (Colman 2003, Soden & Held 2006). Water vapor (WV) and lapse rate (LR) feedbacks are combined because they are highly negatively correlated. Also shown are estimates from Hansen et al. (1985) using one global climate model. The combined feedbacks for Hansen et al. (1985) are calculated assuming that the ranges for individual feedbacks are independent, which was not established in the original paper and thus is included for guidance only. To convert values from the original papers into feedback factors $\lambda_0 = 0.3 \text{ K (W m}^{-2}\text{)}^{-1}$ was assumed.

Figure 4 also shows values given by Hansen et al. (1984), calculated from one simple climate model and without evaluation of the independence of the different feedbacks. Thus, although the uncertainties are not formally equivalent, it is nonetheless remarkable that these different estimates, separated by more than twenty years of intensive research, are so similar.

Calculating feedback factors in the highly coupled and highly complicated climate system is an approximate business. The procedure described above is only one of several techniques. It has neglected various factors such as the effects of spatial correlations and nonlinearities of and among individual feedbacks (see the section Nonlinear Feedbacks, below). Last, in transient climate model integrations, an effective climate sensitivity must be calculated in order to take into account the transient imbalance in the radiation budget. Colman (2003), Soden & Held (2006), and Bony et al. (2006) contain a fuller accounting of these approximations.

Other components of the climate system also act as feedbacks. For example, ocean heat uptake and the strength of the thermohaline circulation (e.g., Wood et al. 2003), as well as the natural carbon cycle (e.g., Torn & Harte 2006) and other biogeochemical processes, have all been suggested to be important. The National Research Council NRC (2003) and Bony et al. (2006) present extended discussions of the various climate system feedbacks. Simple characterizations of such feedbacks can readily be incorporated in the framework described here.

Uncertainties in Feedbacks

How do uncertainties in feedbacks translate into uncertainties in system response? Differentiating Equation 11 with respect to one of the feedbacks gives

$$\delta(\Delta T) = \Delta T_0 \delta G = \frac{\Delta T_0}{(1 - \sum_i f_i)^2} \delta f_i = G^2 \Delta T_0 \delta f_i. \quad (20)$$

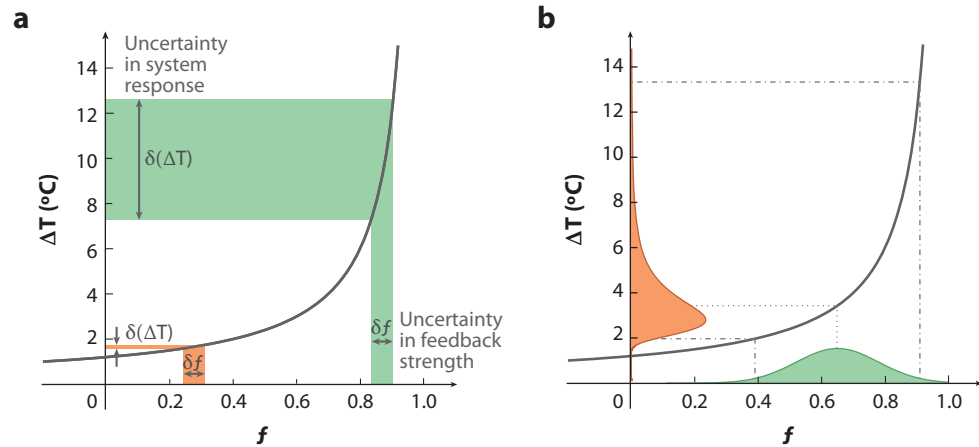

Figure 5

Uncertainties in response as a function of uncertainties in feedbacks, assuming a reference climate sensitivity of $\Delta T_0 = 1.2^\circ\text{C}$. (a) The uncertainty in feedbacks, δf , is the same in both instances, but the uncertainty in the response, $\delta(\Delta T)$, depends enormously on the mean feedback strength, \bar{f} . (b) A Gaussian spread of uncertainties in feedback strength (green shading), $\bar{f} = 0.65$, $\sigma_f = 0.13$, consistent with the GCM studies of Colman (2003) and Soden & Held (2006), produces uncertainty in the system response (orange shading) that is highly skewed. The dotted line is the mean of the distribution, and dash-dotted lines give the 95% confidence interval. From Roe & Baker (2007).

The squared dependence in Equation 20 means that the magnitude of G has a great influence on the how uncertainties in f_i affect uncertainties in the system response (e.g., Charney 1979). Hansen et al. 1984, Schlesinger 1985, Peixoto & Oort 1992, Torn & Harte 2006). This is illustrated graphically in **Figure 5a**. The same uncertainty δf_i has a much larger projection onto $\delta(\Delta T)$ if the average feedbacks are strongly positive than if the average feedbacks are only weakly positive or negative.

Let the mean value of the total feedback factor (i.e., $\sum_i f_i$) be \bar{f} , and let the standard deviation in the i th feedback factor be σ_i . If the values of the σ_i s are mutually independent, then the standard deviation of the sum of all the feedbacks is $\sigma_f = [\sum_i (\sigma_i)^2]^{1/2}$. Even if uncertainties in individual feedbacks are not normally distributed, one can invoke the central limit theorem to argue that, in a system comprised of many feedbacks, and to a good degree of approximation, their combined uncertainty will be normally distributed. This appears to be true for the climate system (e.g., Gregory et al. 2002, Allen et al. 2006). **Figure 5b** (from Roe & Baker 2007) shows how uncertainties in feedbacks project onto the uncertainty in the system response for values characteristic of the spread found in climate models. The $1/(1 - \bar{f})$ shape of the feedback curve means the uncertainty in the system response is highly skewed: There are small but finite probabilities of an extremely large system response (Allen et al. 2006, Roe & Baker 2007). This shape for the envelope of uncertainty of climate sensitivity has been found in many studies (e.g., Gregory et al. 2002, Forest et al. 2002, Stainforth et al. 2005, Roe & Baker 2007) and can be understood as a direct consequence of Equation 11.

Nonlinear Feedbacks

The feedback formalism so far has assumed that feedbacks are a linear function of the system response. It is possible to relax this constraint. From those first-order definitions

Equations 5 and 7 give,

$$\frac{dT}{dR} \approx -\frac{\Delta T}{\Delta R_f} = -\frac{\lambda_0}{1-f}, \quad (21)$$

and so

$$\frac{dR}{dT} = \frac{f-1}{\lambda_0}. \quad (22)$$

Now, the second-order expansion is

$$dR \approx \frac{dR}{dT} \Delta T + \frac{1}{2} \frac{d^2 R}{dT^2} \Delta T^2 + O(\Delta T^3). \quad (23)$$

Retaining second-order terms and rearranging Equation 23 produces

$$\Delta T = \frac{\Delta R}{\frac{dR}{dT} + \frac{\Delta T}{2} \frac{d^2 R}{dT^2}}. \quad (24)$$

This, combined with the derivative of Equation 22, gives

$$\Delta T = \frac{\lambda_0 \Delta R_f}{1-f - \frac{\Delta T}{2} \left(\frac{df}{dT} + \frac{(1-f)}{\lambda_0} \frac{d\lambda_0}{dT} \right)}. \quad (25)$$

The last term in the denominator of Equation 25 reflects the effect of feedback strength and the climate sensitivity parameter, which vary with climate state. Two obvious and important climate processes are certainly nonlinear: the Stefan-Boltzmann law governing longwave radiative fluxes and the Clausius-Clapeyron relationship governing atmospheric moisture content ($F = \sigma T^4$ and $de_{sat}/dT = Le_{sat}/RT^2$, respectively, using standard notation; e.g., Wallace & Hobbs 2006).

The effect of nonlinearities on the system response can be estimated (e.g., Colman et al. 1997, Roe & Baker 2007). Most global climate model studies of climate sensitivity are constrained by experimental design to compare a control with a single perturbation experiment. With only two states to compare, the nonlinearity of feedbacks cannot be evaluated, and this contributes to uncertainty in climate predictions. Colman et al. (1997) consider sequences of perturbed experiments and confirm significant nonlinearities in water vapor, cloud, and atmospheric lapse rate feedbacks.

Note that Equation 25 does not account for interactions between feedbacks, which also enter at the same order. The equivalent expression that includes these cross-terms can be derived from Equations 14, 15, and 16.

FEEDBACKS AND VARIATIONS IN TIME

The comparison between two equilibrium states is fundamental to the feedback analysis presented here, beginning with Equation 1. However, feedbacks are also intrinsically related to the response time of a system, to the variance in a time series of the system forced by stochastic noise, and to the power spectrum. This section reviews these relationships and illustrates them with examples.

Response Time

In the simple climate model, if the system is assumed to have some thermal inertia, C ,⁶ the equation that describes the time-dependent evolution is

$$C \frac{dT}{dt} = S + F + \mathcal{R}_f(t), \quad (26)$$

⁶For general feedback systems, this would be the form of inertia relevant to the problem (i.e., not necessarily thermal inertia).

where some unspecified source of thermal forcing of the system, \mathcal{R}_f , has also been included, with units of $W m^{-2}$. The next step is to linearize around some equilibrium climate state, $T = T_{eq} + T'$. Then, using $R = S + F$, from Equation 26

$$C \frac{dT'}{dt} + \left. \frac{dR}{dT} \right|_{T_{eq}} T' = \mathcal{R}_f(t). \quad (27)$$

The way that the system feedbacks enter in can be seen from Equation 15 or Equation 22. Expressing Equation 27 in terms of the response time of the system, τ , gives

$$\frac{dT'}{dt} + \frac{T'}{\tau} = \frac{\mathcal{R}_f(t)}{C}, \quad (28)$$

where

$$\tau = \frac{C\lambda_0}{1 - \sum_i f_i}. \quad (29)$$

Equation 29 is arguably one of the most important equations in climate dynamics (and system dynamics in general), as it encapsulates four basic and fundamental properties of the climate system: the response time (i.e., memory), the effective inertia, the no-feedback sensitivity parameter, and the sum of the system feedbacks.⁷

Feedback systems that have a sensitive response to forcing (meaning here that the sum of the feedbacks is substantially positive) have inherently long response times. As seen in Equation 4, a positive feedback amplifies the original forcing perturbation. With the feedback, therefore, the system becomes less efficient in counteracting the forcing perturbations. Thus, all else being equal, the system retains those perturbations for longer; that is, the system has a longer response time. Equation 29 shows that the larger the inertia of the system, the longer the response time. **Figure 6** demonstrates this behavior in a simple climate model that is subject to a doubling of CO_2 , given a range of uncertainty in climate feedbacks consistent with the results from GCMs. The more sensitive the system is, the longer it takes to equilibrate.

Thermal inertia is represented in Equation 26 by a single value for C . This assumes there is only a single effective source of inertia in the system. This effective inertia might also vary as a function of time. For example, heat uptake by the deep ocean is largely a diffusive process and can occur only progressively. A purely diffusive ocean heat uptake renders the response time equal to the square of the system gain (e.g., Hansen et al. 1985, Wigley & Schlesinger 1985) (**Figure 6**). Equation 26 also assumes that any lag between the forcing and the feedback response is short compared with the response time, τ . The timescale for adjustment of the atmosphere-ocean mixed layer is on the order of five years; therefore, the major atmospheric feedbacks are considered to be in equilibrium with the evolving climate. However, for ocean circulation and perennial sea ice and other cryosphere adjustments, the assumed scale separation may be more problematic. Depending on the relevant timescale for the particular question of interest, the delay in these longer feedback processes may need to be explicitly represented in the process model.

Nonetheless, it is important to emphasize that, even beyond the strict mathematical domain of validity, the basic physical tendency evinced in Equation 29 can still be confidently anticipated in nature: Systems with positive feedbacks are sensitive to forcing and are inefficient in eliminating perturbations. A long system response time is a direct reflection of that inefficiency.

⁷In this regard it shares traits with the Euler equation: $e^{i\pi} + 1 = 0$.

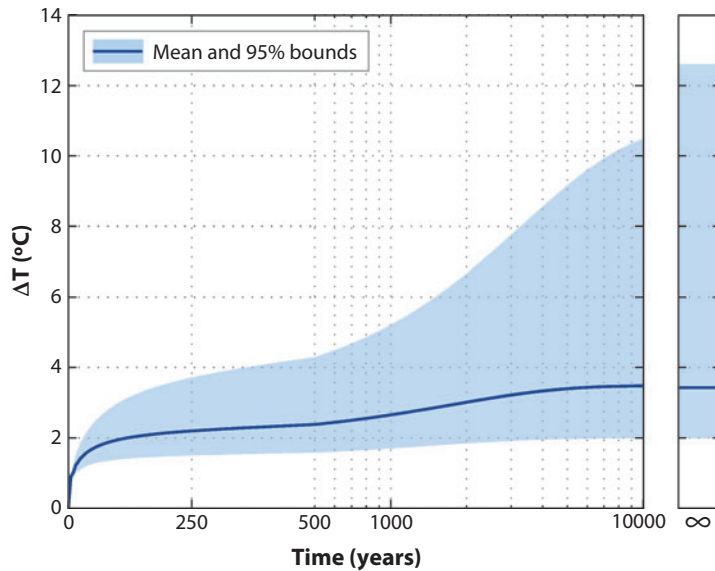

Figure 6

The time evolution of the probability distribution of future climate states, generated by using a simple climate model forced by a step-function climate forcing of $\Delta R_f = 4 \text{ W m}^{-2}$ at $t = 0$. The climate model is a simple advective-diffusive ocean (e.g., Hoffert 1980) beneath an atmosphere that considers a range of different feedback strengths and has a reference climate sensitivity $\Delta T_0 = 1.2^\circ\text{C}$. The black line shows the time evolution of the state with the mean climate sensitivity, and the gray region shows the spread for the 95% confidence interval. Shown at right is the equilibrium (i.e., $t = \infty$) probability distribution. The higher sensitivity climates have a larger response time and thus take longer to equilibrate. Note the switch to a log time axis after 500 years.

Variance

When \mathcal{R}_f is a random process, Equation 28 is known as a continuous first-order autoregressive process, AR(1), or more informally, red noise (e.g., Hasselmann 1976, Jenkins & Watts 1968, vonStorch & Zwiers 1999, Wunsch 1999). The state of the system at a given time is dependent on the previous states (i.e., there is some memory) and on random noise constantly jittering the system away from equilibrium. It represents the simplest possible behavior of a physical system that has inertia and is subject to random noise. All natural geophysical systems share these two properties, and thus it is the default expectation (or null hypothesis) for any geophysical time series. Equation 28 is continuous in time—the case of the equivalent discrete process is given in Appendix A.

Let $b(t)$ be the unit response function for an impulsive forcing in \mathcal{R}_f . The variance in T' is given by

$$\text{var}(T') = \frac{\bar{\sigma}_R^2 \Delta t}{C^2} \int_0^\infty b^2(t) dt, \tag{30}$$

(e.g., Jenkins & Watts 1968, vonStorch & Zwiers 1999), where $\bar{\sigma}_R$ is the variance in the random forcing averaged over some interval Δt .⁸ For Equation 28, $b(t) = \exp(-t/\tau)$, and so

$$\text{var}(T') = \frac{\bar{\sigma}_R^2 \Delta t}{C^2} \times \frac{\tau}{2}, \tag{31}$$

⁸Formally, a continuous random process has infinite variance. The finesse of taking the average value over some finite interval keeps the equations well behaved and dimensionally consistent (e.g., Jenkins & Watts 1968).



Annu. Rev. Earth Planet. Sci. 2009.37. Downloaded from arjournals.annualreviews.org by UNIVERSITY OF WASHINGTON - HEALTH SCIENCES LIBRARIES on 01/16/09. For personal use only.

which, after substitution from Equation 29, gives

$$\text{var}(T') = \frac{\bar{\sigma}_R^2 \Delta t \lambda_0}{2C(1 - \sum_i f_i)}. \quad (32)$$

The more positive the feedbacks are, the greater the variance: Anomalies are stored up and remembered over longer periods of time, leading to larger excursions. Again, this reflects the integrative nature of a system that does not eliminate perturbations efficiently. This is one reason why the claims that the global temperature record primarily reflects natural variability and not anthropogenic forcing miss the mark a little in regard to the implications for global warming. If the temperature reconstructions reflect high natural variability of global mean temperature, then odds are that the climate system is even more sensitive to external forcing (i.e., the positive feedbacks are even larger).

Power Spectrum

Last, we review the power spectrum of Equation 28, which depends on τ and, via Equation 29, on the strength of the feedbacks. Although the emphasis in this section is on the dependence of the spectrum on τ , the spectral analysis of geophysical time series plays an important role in the interpretation of the underlying system dynamics, and so a brief review complements a general discussion of feedbacks. The power spectral density per unit frequency, P , is found by taking the Fourier transform of the autocovariance function (see for example, Jenkins & Watts 1968, vonStorch & Zwiers 1999). This gives

$$P(\nu) = \frac{2\tau}{1 + (2\pi\nu\tau)^2}, \quad (33)$$

where ν refers to frequency. This satisfies the normalization condition that $\int_{-\infty}^{\infty} P(\nu) d\nu = 1$. Equation 33 has greater power at low frequencies and hence, in an analogy with the spectrum of visible light, the process generating it is termed red noise. By integrating Equation 33 with respect to frequency, it can be shown that half of the variance in the spectrum occurs at periods (i.e., $1/\nu$) that are 2π times longer than the physical response time, τ . Thus, what appears in a power spectrum as variability at long periods can be the natural result of physical processes whose timescales are much shorter. This is illustrated in the following three brief examples, two of which are taken from observations and one of which is from a model.

The first example is the Pacific Decadal Oscillation (PDO). The PDO is defined as the leading Empirical Orthogonal Function of sea surface temperatures in the North Pacific (Mantua et al. 1997), and its temporal variability has been shown to correspond to variability in fish stocks and glacier mass balance, among other derivative measures of climate (e.g., Mantua et al. 1997, Bitz & Battisti 1999). The March–April–May (MAM) PDO index for the past 105 years is shown in **Figure 7a**. Springtime is the season for which interannual persistence of sea-surface temperatures is greatest (Deser et al. 2003). A statistical model corresponding to Equation 28 [i.e., an AR(1) process] can be fit to the PDO index using standard statistical fitting methods (e.g., Schneider & Neumaier 2001), and the best-fit value of τ can thus be obtained. This statistical model proves to be a self-consistent representation of the data because the residuals are consistent with uncorrelated white noise at the 95% level. The striking result is that the best-fit τ is 106 ± 0.8 years (95% confidence interval); in other words, much less than decadal timescales. This is confirmed in **Figures 7b** and **7c**, which are random realizations of a red-noise process with this best-fit τ . The similarity to the PDO index is visually obvious: Simply by chance, and given an approximately one-year memory, there are some intervals where the index is above zero for a few years. This

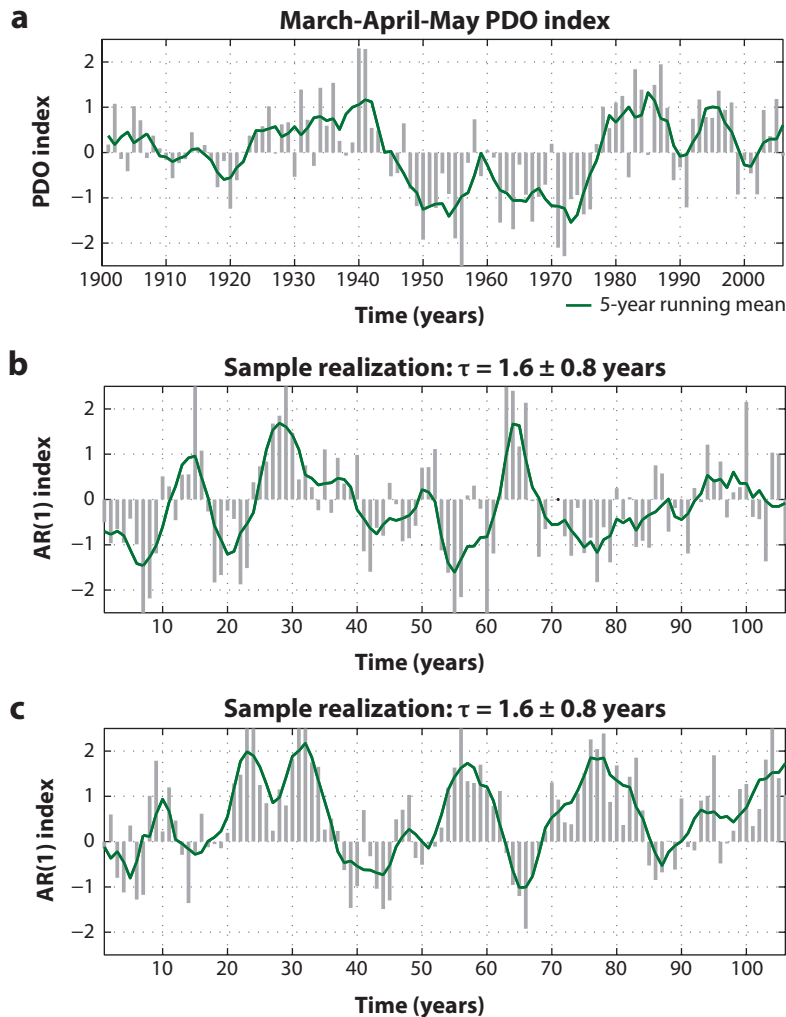

Figure 7

(a) Interannual variations in the springtime (March-April-May, or MAM) PDO index, detrended and normalized (gray bars), with a 5-year running mean (green line). (b, c) Random realizations of a red-noise process with the same statistical characteristics as the index of the PDO. Note the striking visual similarity. The application of a 5-year running mean creates a strong visual impression of decadal variability (data from <http://jisao.washington.edu/data/>).

visual effect is exaggerated when a five-year running mean is imposed on the data, as is often done with such indices, which imparts an appearance of whole decades in one phase or the other.

The spectral estimate of the PDO index is shown in **Figure 8**, along with that of the best-fit red-noise process, and the estimated 95% confidence interval of the red-noise fit given the variance in the PDO index. That the spectral estimate of the PDO index lies largely within those bounds is a further indication that red noise is a consistent explanation of the data. The response time driving this spectrum is indicated by the arrow, and hence the figure emphasizes how much variance occurs at long periods for a process that has a much shorter physical timescale.

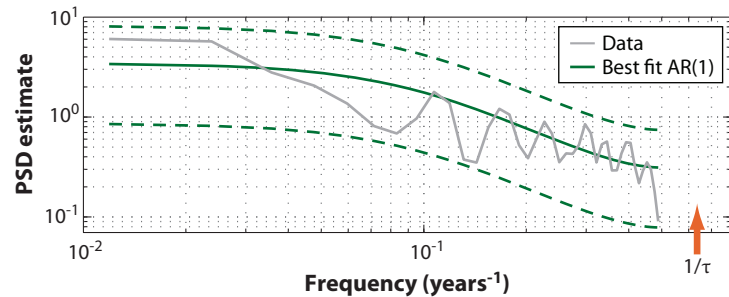

Figure 8

Power spectral estimate of the springtime (March–April–May, or MAM) PDO index (*gray line*) using a periodogram with a 30-year Hanning window; and the theoretical power spectrum of the best-fit red-noise process (*green line*), with a response time of $\tau = 1.6 \pm 0.8$ years. The green-dashed lines give the 95% confidence interval for the red-noise process, and the orange arrow shows $1/\tau$. The spectrum illustrates that half of the variance occurs at periods that are at least 2π times longer than the physical response time.

By these statistical measures, the PDO should be characterized neither as decadal nor as an oscillation (but it is in the Pacific).⁹ However, the measures are slightly too simple—Deser et al. (2003) shows that re-entrainment of wintertime heat anomalies into the following year’s mixed layer provides a consistent explanation for the near annual timescale of the memory, and Newman et al. (2003) have shown additional skill in explaining the PDO if an index of the El Niño Southern Oscillation is included as part of the driving noise. The point is not to demonstrate per force that ocean-atmosphere modes play no active role in the feedback dynamics (e.g., Latif & Barnett 1994, 1996), rather it is to highlight that vast majority of the variance in the PDO can be explained by simple integrative physics with a perhaps surprisingly short timescale. This should be the expectation (i.e., the null hypothesis) in the interpretation of geophysical time series.

The second example is millennial variability in the Antarctic. The $\delta^{18}\text{O}$ record from Byrd, Antarctica, is one of the principal paleoclimate records for the most recent glacial period. It is a proxy for precipitation-weighted temperature and is shown in **Figure 9a** for the 30,000-year interval between 50 thousand years before present (kbp) and 20 kbp, together with the accompanying power spectral estimate. Performing the same statistical fitting as in the previous example produces a best fit $\tau = 500 \pm 200$ years. Again, the results are a strong suggestion that the 3000- to 6000-year variability seen visually and in the power spectra arises from physical processes with characteristic timescales that are considerably less.

As always, the world is a messy place, and this description is not complete. It is argued that the record in Antarctica over this period can be related to the equivalent record in Greenland, particularly during the longer, larger excursions in **Figure 9**, which have been associated with Heinrich events (e.g., Blunier et al. 1998, Hemming 2004, Huybers 2004, Roe & Steig 2004, EPICA et al. 2006). Nonetheless, the exercise suffices to demonstrate that in characterizing this overall record as displaying millennial variability there is a danger of distracting from the timescale of the physical processes driving it, which may be much shorter—in this case, on the order of a few centuries.

Example 3: Glacier response to climate variability. Components of the Earth system that have memory will act as natural integrators of climate variability. **Figure 10a** shows the results of integrating a linear glacier model forced by stochastic interannual precipitation and temperature

⁹Matt Barlow, University of Massachusetts, appears to be the originator of this comment.

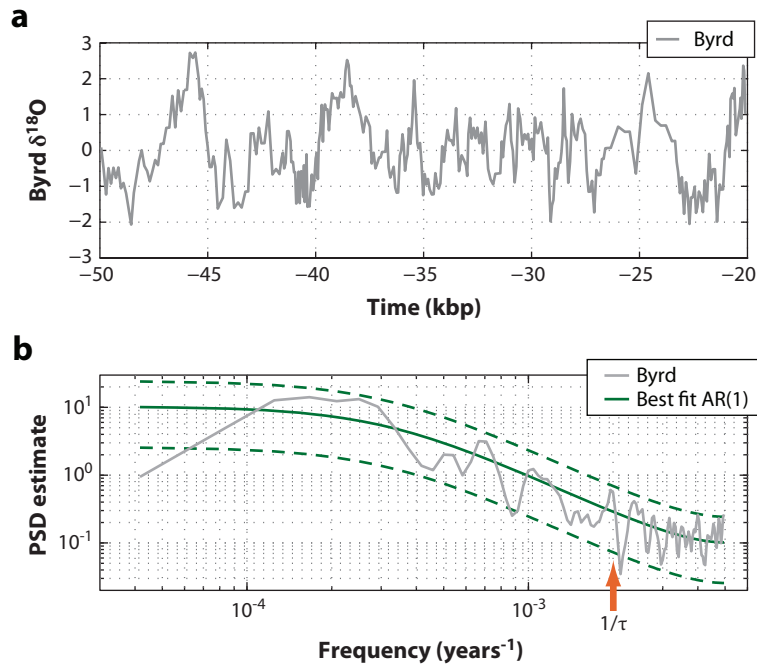

Figure 9

(a) $\delta^{18}O$ from the Byrd ice core, over a 30,000-year interval during the most recent ice age, interpolated to uniform spacing of 200 years, detrended and normalized; (b) power spectral estimate of the Byrd record (gray line), derived from a periodogram using a 10,000-year Hanning window. The green line shows the theoretical power spectrum of the best-fit red-noise process, with a response time $\tau = 500 \pm 200$ years. The green dashed lines give the 95% confidence interval for the red-noise process, and the orange arrow shows $1/\tau$. It is clear that the preponderance of the variance occurs at periods greater than the physical response time. A 30,000-year interval was chosen to minimize any influence from Milankovitch orbital forcing. Modified from Roe & Steig (2004), data from Blunier et al. (1998).

variations that are consistent with the climatological statistics from a mesoscale numerical weather prediction model (G.H. Roe & M.A. O'Neal, submitted). The model emulates the geometry and climate of Easton Glacier on Mt. Baker in Washington State. The response time of the linear model is just 17 years, but note the large (2 to 3 km) variability on multicentennial timescales. Positive dynamical feedbacks such as glacier thickness variations (e.g., Oerlemans 2001) or subglacial hydrological processes, which are not included in the linear model, would act to lengthen the timescale of variability.

Because climate is the statistics of weather, the sample climate used to generate **Figure 10a** is constant (i.e., constant mean and standard deviation). The dots above the time series indicate maximum advances not subsequently over-ridden, and so suggest times when moraines might be left on the landscape. None of these landscape features should be interpreted as a climate change: Centennial and millennial variability are inherent in glaciers with decadal memory, even in a constant climate.

The same behavior applies to other components of the system that have long memory, such as perennial sea ice (e.g., Thorndike 1992, Bitz & Roe 2004) or large lakes (e.g., Kutzbach 1980). It complicates the interpretation of true past climate changes, as the response due to the integration of natural interannual variability must be factored out. Also, identifying the appropriate response

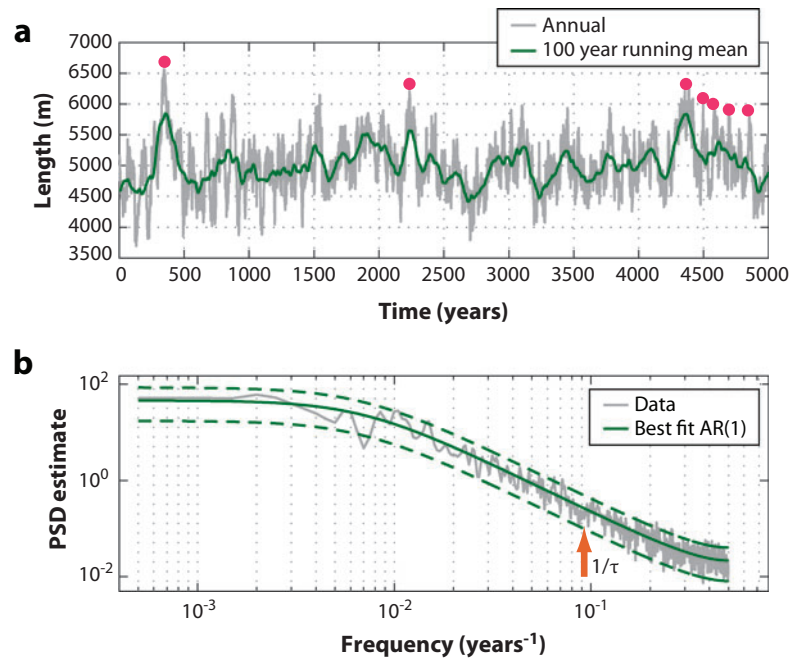

Figure 10

Glacier terminus variability in a constant climate. (a) Sample realization of glacier terminus variations from a linear glacier model with a 17-year dynamical response time. Note the 2–3 km magnitude of the apparent centennial-scale variability. The dots indicate maximum advances not subsequently overridden and thus suggest times when moraines might be left on the landscape. (b) Power spectral estimate of (a), from a periodogram using a 1000-year Hanning window. The green line shows the theoretical power spectrum of the glacier model, the green dashed lines give the 95% confidence interval, and the orange arrow shows $1/\tau$. Reproduced with permission from G.H. Roe & M.A. O’Neal.

times for a time series of observations gives important information about the system dynamics. In particular, it can be used to try to constrain the system sensitivity and feedbacks via Equation 29 (e.g., Lindzen 1994, Lindzen & Giannitsis 1998).

DISCUSSION

Clear and consistent definitions are essential in analyzing feedbacks. The very idea of a feedback implicitly partitions a system into a feedback process and a reference system on which that process acts. If you change the reference system, you change the feedback. Feedbacks can be meaningfully defined only when also accompanied by a choice and a clear definition of the reference system. In general, there is no single correct choice, and which one makes most sense depends on the problem. Loosely speaking, one possibility is to think of the reference system as containing the things that are known well, as in the case of choosing a blackbody planet as the reference for the climate system, and to think of the feedbacks as the things that are uncertain.

Another possible partition is to regard the reference system as the things not being studied and to think of the feedbacks as the processes of interest. Here, though, it becomes important to appreciate that the expression for f_i in Equation 19 depends on the reference state. When feedback processes are compared quantitatively, it is a requirement that they have been evaluated against the same reference system. Consider the following example. In studying the role of sea

ice in climate change, a climate model might be integrated twice—once with and once without dynamical sea ice in a global warming scenario. There would be some differences in the resulting climate change. It would be possible to quantify these differences in terms of feedback factors and gains for the sea-ice feedback. The same exercise might also be done for some aspect of a cloud parameterization. However, these two analyses have different reference systems—one reference system has static sea ice and dynamical clouds, whereas in the other reference system the converse is the case. Therefore, the gains and feedback factors so derived are not directly comparable. Moreover, because of Equation 18 and the argument immediately below it, the applied forcing in these two cases needs to be interpreted differently. In order to make the direct comparison between the two feedbacks, the reference case ought to have both processes switched off.

It is also worth mentioning that what even counts as a feedback depends on the definition of the reference system. For example, the Stefan-Boltzman relation is often described as a negative climate feedback acting to regulate temperature anomalies. In fact, for a blackbody planet, which is the simplest imaginable reference system for the climate that is still meaningful, the Stefan-Boltzman relation is part of the reference system and therefore not a feedback at all. These are not semantic or esoteric issues—the quantitative intercomparison of different feedbacks can be done only when the reference system is defined and held constant.

In addition to the choice of the reference system, the output variable is also important. In the development presented here, we took global- and annual-mean temperature. However, the magnitude of the feedbacks will change if a different variable is chosen because the Taylor series at the core of feedbacks in Equation 14 is an expansion in terms of the output variable. For a different choice of output variables, the feedback factors and gains associated with a particular physical process will be different. Moreover, even the sign of the feedbacks can change. For example, interactive water vapor acts a positive feedback when global- and annual-mean temperature is the output variable. However, if the output variable is the intensity of evaporative fluxes, interactive water vapor becomes a negative feedback: Changes in moisture fluxes are damped compared with a climate system with fixed specific humidity.

The definition of f_i in Equation 16 comes from a first-order Taylor series expansion around an equilibrium state. Strictly speaking, feedback factors are calculated for, and are only applicable to, one specific state of the system. Therefore, when comparing two different states, the validity of the linear extrapolation needs to be established. For nonlinear feedbacks, the effect of the feedback processes on the system response must be evaluated by integrating from the initial to the final state, keeping track of how the feedbacks change (i.e., Equation 25).

The complications raised here are not flaws or downsides of the framework of feedback analysis. They are inherent to dynamical systems where everything influences everything else. Any effort to untangle the interactions must, of necessity, make a careful accounting of how the system is being sliced and diced to study the pieces. Not doing so can lead to significant errors and misinterpretations. These issues are subtle, and it is in fact a strength of feedback analysis that it brings them to light and makes their dependencies clear.

Feedbacks are intrinsically related to the timescale of the system response. Positive feedbacks amplify perturbations, and mean the system is inefficient in eliminating those perturbations. All else being equal, it therefore takes longer to return to equilibrium. One consequence is that the output from systems with higher sensitivity will also have higher variance. These are robust physical tendencies, as is the general result that for natural systems driven by stochastic forcing, natural variability is expressed at periods that are much longer than the physical response time.

There are other ways of defining feedbacks. Bates (2007) distinguishes between two different definitions of feedbacks, both of which are in common and somewhat indiscriminate use in the climate literature. He terms the feedback defined in the present paper a sensitivity-altering



feedback—one that changes the asymptotic limit of the system response to a step change in forcing. Bates also points out that another common usage of the term feedback is as a stability-altering feedback, one which alters the rate of change of the system to an impulsive forcing. He shows that, under certain circumstances, the sign of the feedbacks in these different senses can be different, thus they need to be carefully distinguished.

Feedbacks were presented here using a simple climate model based on a statement of conservation of energy. Equally well, a physical system constrained by conservation of momentum or mass (e.g., Roe et al. 2008) might have been used. Provided there is a clear physical model for which there is a forcing and a response, and there is a physical process that makes the forcing a function of the response, feedback analysis can be used to characterize the system dynamics.

The simulation of Earth systems is fundamentally a probabilistic enterprise. As model systems increase in complexity, the number of feedback processes increase, and it is important to address how uncertainties in the representation of those physical processes translate into the uncertainty of the system response. Atmosphere-ocean general circulation models have reached a much higher level of sophistication and complexity than many other Earth system models. The experience from climate modeling will likely translate to tackling challenges of similarly irreducible complexity (such as geochemical cycles, landscape dynamics, and glacier and ice sheet dynamics). When the net feedbacks are substantially negative, the system response to a forcing can be well characterized even though the individual feedbacks may be quite uncertain. However, when the net feedbacks are substantially positive, a high degree of uncertainty in the system response is inevitable as a fundamental and inescapable consequence of the amplification by the system dynamics (**Figure 5**) (Roe & Baker 2007). Unfortunately, it is often the positive feedback systems (i.e., a large response for a small forcing) that are of most interest both scientifically and societally. In these cases, the most important implication is that, rather than trying to solve for the specific system response to a given forcing, it may be that characterizing the feedbacks and their uncertainties is the better and more tractable scientific goal.

APPENDIX A: DISCRETE AUTOREGRESSIVE PROCESS

The discrete form of Equation 28 is

$$\frac{T_{t+\Delta t} - T_t}{\Delta t} + \frac{T_t}{\tau} = \left(\frac{\bar{\sigma}_R}{C} \right) \beta_t, \quad (\text{A-1})$$

where β_t is a normally distributed white noise process of unit variance. Rearranging Equation A-1 gives

$$T_{t+\Delta T} = T_t \left(1 - \frac{\Delta t}{\tau} \right) + \left(\frac{\bar{\sigma}_R}{C} \right) \beta_t \Delta t. \quad (\text{A-2})$$

Let $\langle \rangle$ stand for the expected value of $\langle \rangle$. Using the relations $\langle T_t \beta_t \rangle = 0$ and $\langle T_{t+\Delta T} T_{t+\Delta T} \rangle = \langle T_t T_t \rangle$, the variance of a system governed by Equation A-2 can be calculated from the expected value of T^2 :

$$\text{var}(T) = \langle T_t \cdot T_t \rangle = \left(\frac{\bar{\sigma}_R \tau}{C} \right)^2 \cdot \frac{\Delta t}{2\tau - \Delta t} \quad (\text{A-3})$$

$$= \left(\frac{\bar{\sigma}_R \lambda_0}{1 - \sum_i f_i} \right)^2 \cdot \frac{\Delta t}{2\tau - \Delta t}. \quad (\text{A-4})$$

For the case where $\Delta t \ll \tau$, Equation A-3 is equivalent to Equation 31. The power spectrum for Equation A-2 is found from the discrete Fourier transform of the autocovariance function



(e.g., Jenkins & Watts 1968, vonStorch & Zwiers 1999):

$$P(v_i) = \frac{\Delta t(1 - \rho^2)}{1 + \rho^2 - 2\rho \cos(2\pi v_i \Delta t)}, \quad (\text{A-5})$$

where v_i in the above equation refers to frequency, $\rho = 1 - \Delta t/\tau$ is the lag-1 correlation coefficient, and P is power spectral density per unit frequency. Equation A-5 meets the normalization condition that $\sum_{i=-N/2}^{i=N/2} P(v_i)\Delta v = 1$, where $N = T/\Delta T$, $\Delta v = 1/T$, and T is the length of the record.

DISCLOSURE STATEMENT

The author is not aware of any biases that might be perceived as affecting the objectivity of this review.

ACKNOWLEDGMENTS

I have had more fun than anyone has a right to in talking over these ideas with Marcia Baker, who gently pointed out my errors in thought and math, and I am indebted to Richard Lindzen for teaching me the method. Feedback from Mark Brandon, David Battisti, Carl Wunsch, and Chris Brierly was also extremely insightful.

LITERATURE CITED

- Allen MR, Andronova N, Booth B, Dessao S, Frame D, et al. 2006. Observational constraints on climate sensitivity. In *Avoiding Dangerous Climate Change*, ed. HJ Schellnhuber, W Cramer, N Nakicenovic, T Wigley, G Yohen, pp. 281–89. Cambridge, UK: Cambridge Univ. Press
- Arhennius S. 1896. On the influence of carbon acid in the air upon the temperature of the ground. *Philosoph. Mag.* 41:237–76
- Bates JR. 2007. Some considerations of the concept of climate feedback. *Quat. J. R. Met. Soc.* 133:545–60
- Bitz CM, Battisti DS. 1999. Interannual to decadal variability in climate and the glacier mass balance in Washington, western Canada, and Alaska. *J. Climate* 12:3181–96
- Bitz CM, Roe GH. 2004. A Mechanism for the high rate of sea-ice thinning in the Arctic Ocean. *J. Climate* 17:3623–32
- Black HS. 1977. Inventing the negative feedback amplifier. *IEEE Spectrum* 14:55–60
- Blunier T, Chappellaz J, Schwander J, Daullenbach A, Stauffer B, et al. 1998. Asynchrony of Antarctic and Greenland climate change during the last glacial period. *Nature* 392:739–43
- Bode HW. 1945. *Network Analysis and Feedback Amplifier Design*. New York: Van Nostrand
- Bony S, Colman R, Kattsov VM, Allan RP, Bretherton CS, et al. 2006. How well do we understand and evaluate climate change feedback processes? *J. Climate* 19:3445–82
- Cess RD. 1975. Global climate change: an investigation of atmospheric feedback mechanisms. *Tellus* 27:193–98
- Cess RD, Potter GL, Blanchet JP, Boer GJ, Del Denio AD, et al. 1990. Intercomparison and interpretation of cloud-climate feedback processes in nineteen atmospheric general circulation models. *J. Geophys. Res.* 95:16601–15
- Charney J, Arakawa A, Baker DJ, Bolin B, Dickinson RE. 1979: *Carbon Dioxide and Climate: A Scientific Assessment*. Washington, DC: Natl. Acad. Sci.
- Colman R, Power S, McAvaney B. 1997. Non-linear climate feedback analysis in an atmospheric GCM. *Climate Dyn.* 13:717–31
- Colman R. 2003. A comparison of climate feedbacks in general circulation models. *Climate Dyn.* 20:865–73
- Croll J. 1864. On the physical cause of the change of climate during geological epochs. *Philos. Mag.* 28:121–37
- Deser C, Alexander MA, Timlin MS. 2003. Understanding the persistence of sea surface temperature anomalies in midlatitudes. *J. Climate* 16:57–72



- EPICA community members. 2006. One-to-one coupling of glacial climate variability in Greenland and Antarctica. *Nature* 444:195–98
- Forest CE, Stone PH, Sokolov A, Allen MR, Webster MD. 2002. Quantifying uncertainties in climate system properties with the use of recent climate observations. *Science* 295:113–17
- Graeme JG. 1996. *Optimizing Op-Amp Performance*. New York: McGraw-Hill
- Gregory JM, Stouffer RJ, Raper SCB, Stott PA, Rayner NA. 2002. An observationally based estimate of the climate sensitivity. *J. Climate* 15:3117–21
- Hansen J, Laci A, Rind D, Russell G, Stone P, et al. 1984. Climate sensitivity: analysis of feedback mechanisms. In *Climate Processes and Climate Sensitivity*, ed. JE Hansen, T Takahashi, *Geophys. Monogr.*, 29:130–63. Washington, DC: Amer. Geophys. Union
- Hansen J, Russell G, Laci A, Fung I, Rind D, Stone P. 1985. Climate response times: dependence on climate sensitivity and ocean mixing. *Science* 229:857–59
- Hasselmann K. 1976. Stochastic climate models, Pt. 1, theory. *Tellus* 26:473–85
- Hemming SR. 2004. Heinrich events: massive late Pleistocene detritus layers of the North Atlantic and their global climate imprint. *Rev. Geophys.* 42:RG1005
- Hoffert MI, Callegari AJ, Hsieh CT. 1980. The role of deep sea heat storage in the secular response to climatic forcing. *J. Geophys. Res.* 85:6667–79
- Huybers P. 2004. Comments on: coupling of the hemispheres in observations and simulations of glacial climate change. *Quat. Sci. Rev.* 23:207–12
- Jenkins GM, Watts DG. 1968. *Spectral Analysis and Its Applications*. San Francisco: Holden-Day. 523 pp.
- Kline R. 1993. Harold Black and the negative feedback amplifier. *IEEE Control Syst.* 13:82–85
- Kories R, Schmidt-Waller H. 2003. *Electrical Engineering: A Pocket Reference*. Berlin: Springer
- Kutzbach JE. 1980. Estimates of past climate at paleolake Chad, North Africa, based on hydrological and energy-balance model. *Quat. Res.* 14:210–23
- Latif M, Barnett TP. 1994. Causes of decadal climate variability over the North Pacific and North America. *Science* 266:634–37
- Latif M, Barnett TP. 1996. Decadal climate variability over the North Pacific and North America: dynamics and predictability. *J. Clim.* 9:2407–23
- Lindzen RS. 1994. Climate dynamics and global change. *Annu. Rev. Fluid. Mech.* 26:353–78
- Lindzen RS, Giannitsis C. 1998. On the climatic implications of volcanic cooling. *J. Geophys. Res.* 103:5929–41
- Lovelock JE, Margulis L. 1974. Atmospheric homeostasis by and for the biosphere: the gaia hypothesis. *Tellus* 26:2–10
- Manabe S, Wetherald RT. 1967. Thermal equilibrium of the atmosphere with a given distribution of relative humidity. *J. Atmos. Sci.* 24:241–59
- Mantua NJ, Hare SR, Zhang Y, Wallace JM, Francis RC. 1997. A Pacific interdecadal climate oscillation with impacts on salmon production. *Bull. Am. Meteorol. Soc.* 78:1069–79
- Maxwell JC. 1867. On governors. *Proc. R. Soc. London* 16:270–83
- Natl. Res. Counc. (NRC). 2003. *Understanding Climate Change Feedbacks*. Washington, DC: Natl. Res. Counc.
- Newman M, Compo GP, Alexander MA. 2003. ENSO-forced variability of the Pacific Decadal Oscillation. *J. Clim.* 16:3853–57
- Oerlemans J. 2001. *Glaciers and Climate Change*. Lisse: Balkema
- Peixoto JP, Oort AH. 1992. *Physics of Climate*. New York: Am. Inst. Phys. 520 pp.
- Roe GH, Baker MB. 2007. Why is climate sensitivity so unpredictable? *Science* 318:629–32
- Roe GH, Steig EJ. 2004. Characterization of millennial-scale climate variability. *J. Clim.* 17:1929–44
- Roe GH, Whipple KX, Fletcher JK. 2008. Feedbacks between climate, erosion, and tectonics in a critical wedge orogen. *Am. J. Sci.* 308:815–42
- Schlesinger ME. 1985. Feedback analysis of results from energy balance and radiative-convective models. In *The Potential Climatic Effects of Increasing Carbon Dioxide*, ed. MC MacCracken, FM Luther, pp. 280–319. Washington, DC: U. S. Dep. Energy, DOE/ER-0237
- Schlesinger ME. 1988. Quantitative analysis of feedbacks in climate model simulations of CO₂ induced warming. In *Physically-Based Modeling and Simulation of Climate and Climate Change*, ed. ME Schlesinger, NATO ASI Ser. C, 243:653–737. Norwell, MA: Kluwer Acad.

- Schneider SH. 1972. Cloudiness as a global feedback mechanism: the effect of radiation balance and surface temperature of variations in cloudiness. *J. Atmos. Sci.* 29:1413–22
- Schneider T, Neumaier A. 2001. Algorithm 808: ARfit—a Matlab package for the estimation of parameters and eigenmodes of multivariate autoregressive models. *ACM Trans. Math. Softw.* 27:58–65
- Smith A. 1776. *An Inquiry into the Nature and Causes of the Wealth of Nations*, ed. E Cannan. London: Methuen. 781 pp.
- Soden BJ, Held IM. 2006. An assessment of climate feedbacks in coupled oceanatmosphere models. *J. Clim.* 19:3354–60
- Stainforth DA, Aina T, Christensen C, Collins M, Faull N, et al. 2005. Uncertainty in predictions of the climate response to rising levels of greenhouse gases. *Nature* 433:403–6
- Thorndike AS. 1992. A toy model linking atmospheric thermal radiation and sea ice growth. *J. Geophys. Res.* 97:9401–10
- Torn MS, Harte J. 2006. Missing feedbacks, asymmetric uncertainties, and the underestimation of future warming. *Geophys. Res. Lett.* 33:L10703
- Trenberth K, ed. 1992. *Climate System Modelling*. Cambridge, UK: Cambridge Univ. Press
- vonStorch H, Zwiers FW. 1999. *Statistical Analysis in Climate Research*. Cambridge, UK: Cambridge Univ. Press. 484 pp.
- Wallace JM, Hobbs PV. 2006. *Atmospheric Science: An Introductory Survey*. San Diego, CA: Academic
- Wetherald R, Manabe S. 1988. Cloud feedback processes in a general circulation model. *J. Atmos. Sci.* 45:1397–415
- Wigley TML, Schlesinger ME. 1985. Analytical solution for the effect of increasing CO₂ on global mean temperature. *Nature* 315:649–52
- Wood RA, Vellinga M, Thorpe R. 2003. Global warming and thermohaline circulation stability. Abrupt climate change: evidence, mechanisms and implications. *Philos. Trans. Math. Phys. Eng. Sci.* No. 361(1810):1961–75
- Wunsch C. 1999. The interpretation of short climate records, with comments on the North Atlantic and Southern Oscillations. *Bull. Am. Meteorol. Soc.* 80:245–55
- Zhang MH, Cess RD, Hack JJ, Kiehl JT. 1994. Diagnostic study of climate feedback processes in atmospheric GCMs. *J. Geophys. Res.* 99:5525–37